

## Symbols













International electrical symbols used on the Product and in this document are explained below.

**FLUKE**

# BC500

## Universal Mains-Power Adapter

### Instruction Sheet

| Symbol   | Description  |
|--|--|
|  | WARNING - RISK OF DANGER. Consult user documentation.  |
|  | WARNING. HAZARDOUS VOLTAGE. Risk of electric shock.  |
|  | DC (Direct Current)  |
|  | Double Insulated   |
|  | Conforms to European Union directives.   |
|  | Energy Efficiency Level VI   |
|  | This product complies with the WEEE Directive marking requirements. The affixed label indicates that you must not discard this electrical/electronic product in domestic household waste. Product Category: With reference to the equipment types in the WEEE Directive Annex I, this product is classed as category 9 "Monitoring and Control Instrumentation" product. Do not dispose of this product as unsorted municipal waste. |
|  | Conforms to relevant South Korean EMC Standards.   |
|  | Certified by ETL Intertek to North American safety standards.  |
|  | Conforms to relevant Australian Safety and EMC standards.  |
|  | Conforms to relevant Safety standards in Japan   |
|  | 10 year Environment Friendly Use Period (EFUP) under China Regulation - Administrative Measure on the Control of Pollution Caused by Electronic Information Products. This is the period of time before any of the identified hazardous substances are likely to leak out, causing possible harm to health and the environment.  |

### Introduction

The BC500 is a universal mains-power adapter (the Adapter or Product) for measurement, control, and laboratory equipment. The Adapter is intended for operating and charging the Fluke BT500-Series Battery Testers. The Adapter is based on the switched-mode concept for high efficiency and low stand-by power consumption, and complies with level-VI requirements. It operates in a wide range of input voltages from 100 Vac up to 240 Vac nominal.

A mains cord is included to make the Adapter suitable for most types of mains outlet.

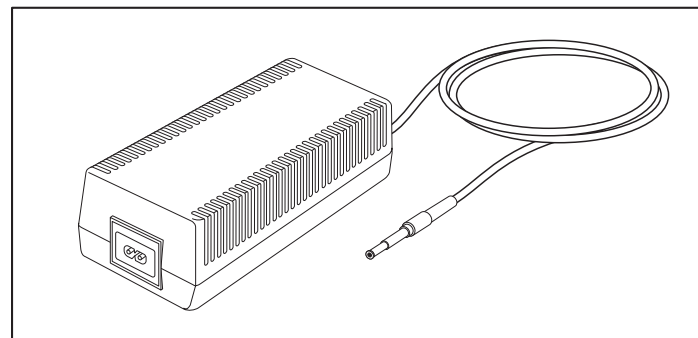

### How to Contact Fluke

To contact Fluke, call one of the following telephone numbers:

- Technical Support USA: 1-800-44-FLUKE (1-800-443-5853)
- Calibration/Repair USA: 1-888-99-FLUKE (1-888-993-5853)
- Canada: 1-800-36-FLUKE (1-800-363-5853)
- Europe: +31 402-675-200
- Japan: +81-3-6714-3114
- Singapore: +65-6799-5566
- China: 400 921 0835
- Anywhere in the world: +1-425-446-5500

Or, visit Fluke's website at [www.fluke.com](http://www.fluke.com).

To register your product, visit <http://register.fluke.com>.

To view, print, or download the latest manual supplement, visit <http://us.fluke.com/usen/support/manuals>.

### LIMITED WARRANTY AND LIMITATION OF LIABILITY

This Fluke product will be free from defects in material and workmanship for one year from the date of purchase. This warranty does not cover fuses, disposable batteries, or damage from accident, neglect, misuse, alteration, contamination, or abnormal conditions of operation or handling. Resellers are not authorized to extend any other warranty on Fluke's behalf. To obtain service during the warranty period, contact your nearest Fluke authorized service center to obtain return authorization information, then send the product to that Service Center with a description of the problem.

THIS WARRANTY IS YOUR ONLY REMEDY. NO OTHER WARRANTIES, SUCH AS FITNESS FOR A PARTICULAR PURPOSE, ARE EXPRESSED OR IMPLIED. FLUKE IS NOT LIABLE FOR ANY SPECIAL, INDIRECT, INCIDENTAL OR CONSEQUENTIAL DAMAGES OR LOSSES, ARISING FROM ANY CAUSE OR THEORY. Since some states or countries do not allow the exclusion or limitation of an implied warranty or of incidental or consequential damages, this limitation of liability may not apply to you.

Fluke Corporation  
P.O. Box 9090  
Everett, WA 98206-9090  
U.S.A.

Fluke Europe B.V  
P.O. Box 1186  
5602 BD Eindhoven  
The Netherlands

PN 4862400  
January 2017

© 2017 Fluke Corporation. All rights reserved. Product specifications are subject to change without notice.

## Safety Information

A **Warning** identifies conditions and procedures that are dangerous to the user.

### Warning

To prevent electrical shock, fire, or personal injury:

- Read these instructions carefully before using the Product.
- Use the Product only with Fluke test tools that have the type number 'BC500' specified for charge and operation.
- Use this Product only as specified.
- Do not open the Product, it has no user-serviceable parts inside.
- Do not use the Product around explosive gas, vapor, or in damp or wet environments.
- Use this Product indoors only.
- Examine the case before you use the Product. Look for cracks or missing plastic. Carefully look at the cable jacket and insulation around the terminals.
- Use only the mains power cord and connector approved for the voltage and plug configuration in your country and rated for the Product.
- Replace the mains power cord if the insulation is damaged or if the insulation shows signs of wear.
- Do not use the Product if it is altered or damaged.

## Unpack

The Adapter includes these items:

- BC500 Switch Mode Power Adapter (main unit) with dc cable
- 2-wire mains cords with male and female connector

At delivery of the Adapter, make sure that the shipment is complete and all items are undamaged. Contact your supplier if you see any damage.

## Operation

The power cord connects the Adapter to the mains system. Do not block access to the power cord and power plug, these must remain accessible to the user at all times.

The Adapter is not equipped with a power switch. Disconnect the mains plug from the mains system when not in use.

In case the Adapter is damaged or any damage is suspected, disconnect from the mains system and have qualified service personnel inspect the Adapter before reconnecting to the mains system again.

To use:

1. Connect the mains cord to the Adapter.
2. Connect the power plug to the mains system.
3. Connect the dc plug to the test tool.

For continuous operation and recording with the test tool, keep the power adapter connected.

## Note

Always fully charge the test tool battery before storage.

## Specifications

### Input

|                               |                                |
|-------------------------------|--------------------------------|
| Nominal input voltage .....   | 100 Vac to 240 Vac, $\pm 10\%$ |
| Input current.....            | 0.35 A at max. load            |
| Nominal input frequency ..... | 50 Hz to 60 Hz $\pm 5\%$       |
| Mains inlet.....              | IEC 60320-1 type C8            |
| Input power, no load.....     | <0.1 W (@ 115 / 230 Vac)       |

### Output

|                          |  |
|--------------------------|--|
| Output voltage.....      | 18 Vdc $\pm 5\%$                               |
| Output current.....      | 0 mA to 840 mA                                 |
| Output cable length..... | 2 m (6.5 ft)                                   |
| Output connector .....   | 5.5 mm outer diameter, per DIN45232            |
| Output polarity.....     | Inner contact positive, outer contact negative |

### Physical characteristics

|                                |                        |
|--------------------------------|------------------------|
| Dimensions of main unit.....   | 79 mm x 149 mm x 49 mm |
| Housing material.....          | Heat resistant ABS     |
| Color (housing and cable)..... | Black                  |
| Weight.....                    | 0.35 kg                |
| Ingress Protection .....       | IEC 60529, IP40        |

### Environmental

|                            |  |
|----------------------------|--|
| Operating temperature..... | 0 °C to 50 °C, up to 90 % rel. humidity, no condensation |
| Storage temperature.....   | -40 °C to +70 °C, 10 % to 95 % rel. humidity             |
| Max. altitude.....         | 2000 m (6562 ft) above sea-level                         |

### Included accessories

|                        |   |
|------------------------|---|
| Power cord.....        | 2-wire cord, with female connector acc. IEC60320 style C7 |
| Mains cord length..... | 1.8 m (6 ft), male to female                              |

**Safety**..... IEC 61010-1, IEC 61010-2-030: CAT IV 600 V, Pollution Degree 2

### Electromagnetic

**Compatibility (EMC)**..... IEC 61326-1: Industrial Electromagnetic Environment  
CISPR 11: Group 1, Class A

*Group 1: Equipment has intentionally generated and/or use conductively coupled radio-frequency energy which is necessary for the internal functioning of the equipment itself.*

*Class A: Equipment is suitable for use in all establishments other than domestic and those directly connected to a low voltage power supply network which supplies buildings used for domestic purposes. There may be potential difficulties in ensuring electromagnetic compatibility in other environments, due to conducted and radiated disturbances.*

*Caution: This equipment is not intended for use in residential environments and may not provide adequate protection to radio reception in such environments.*

Korea (KCC)..... Class A Equipment (Industrial Broadcasting & Communication Equipment)

*Class A: Equipment meets requirements for industrial electromagnetic wave equipment and the seller or user should take notice of it. This equipment is intended for use in business environments and not to be used in homes.*