

SMFT-1000

Multifunction PV Analyzer

Users Manual

LIMITED WARRANTY AND LIMITATION OF LIABILITY

Each Fluke product is warranted to be free from defects in material and workmanship under normal use and service. The warranty period is 3 years and begins on the date of shipment. Parts, product repairs, and services are warranted for 90 days. This warranty extends only to the original buyer or end-user customer of a Fluke authorized reseller, and does not apply to fuses, disposable batteries, or to any product which, in Fluke's opinion, has been misused, altered, neglected, contaminated, or damaged by accident or abnormal conditions of operation or handling. Fluke warrants that software will operate substantially in accordance with its functional specifications for 90 days and that it has been properly recorded on non-defective media. Fluke does not warrant that software will be error free or operate without interruption.

Fluke authorized resellers shall extend this warranty on new and unused products to end-user customers only but have no authority to extend a greater or different warranty on behalf of Fluke. Warranty support is available only if product is purchased through a Fluke authorized sales outlet or Buyer has paid the applicable international price. Fluke reserves the right to invoice Buyer for importation costs of repair/replacement parts when product purchased in one country is submitted for repair in another country.

Fluke's warranty obligation is limited, at Fluke's option, to refund of the purchase price, free of charge repair, or replacement of a defective product which is returned to a Fluke authorized service center within the warranty period.

To obtain warranty service, contact your nearest Fluke authorized service center to obtain return authorization information, then send the product to that service center, with a description of the difficulty, postage and insurance prepaid (FOB Destination). Fluke assumes no risk for damage in transit. Following warranty repair, the product will be returned to Buyer, transportation prepaid (FOB Destination). If Fluke determines that failure was caused by neglect, misuse, contamination, alteration, accident, or abnormal condition of operation or handling, including overvoltage failures caused by use outside the product's specified rating, or normal wear and tear of mechanical components, Fluke will provide an estimate of repair costs and obtain authorization before commencing the work. Following repair, the product will be returned to the Buyer transportation prepaid and the Buyer will be billed for the repair and return transportation charges (FOB Shipping Point).

THIS WARRANTY IS BUYER'S SOLE AND EXCLUSIVE REMEDY AND IS IN LIEU OF ALL OTHER WARRANTIES, EXPRESS OR IMPLIED, INCLUDING BUT NOT LIMITED TO ANY IMPLIED WARRANTY OF MERCHANTABILITY OR FITNESS FOR A PARTICULAR PURPOSE. FLUKE SHALL NOT BE LIABLE FOR ANY SPECIAL, INDIRECT, INCIDENTAL OR CONSEQUENTIAL DAMAGES OR LOSSES, INCLUDING LOSS OF DATA, ARISING FROM ANY CAUSE OR THEORY.

Since some countries or states do not allow limitation of the term of an implied warranty, or exclusion or limitation of incidental or consequential damages, the limitations and exclusions of this warranty may not apply to every buyer. If any provision of this Warranty is held invalid or unenforceable by a court or other decision-maker of competent jurisdiction, such holding will not affect the validity or enforceability of any other provision.

Fluke Corporation
P.O. Box 9090
Everett, WA 98206-9090
U.S.A.

11/99

Table of Contents

Title	Page
Introduction.....	1
Contact Fluke	2
Safety Information.....	2
Specifications	2
Before you Start	7
Kit Contents	7
Accessories	8
How to Use the Rotary Dial.....	9
Buttons.....	10
Info Button	11
Display	11
Terminals/Test Leads.....	12
Error Messages.....	13
How to Zero the Test Leads.....	14
Test Setup	15
Pair PV Analyzer to the Irradiance Meter	15
IEC 62446-1 Category 1 Tests	16
Visual Inspection	16
Continuity of Protective Earthing and Equipotential Bonding Conductors.....	17
Set Limits.....	17
Resistance Test (R_{LO})	18
Resistance of Earthing and Equipotential Bonding Conductors.....	18
Lightning Protection Conductor Wiring.....	18
Grounding System	19
Polarity Test	19
PV String Combiner Box	19
PV String.....	20
Voltage/Current Test (V_{OC}/I_{SC}).....	21
Select PV Model.....	22
Paired with Irradiance Meter Only.....	22
Quick V_{OC}/I_{SC} Measurement	23
V_{OC} /Operational Current Measurement.....	23

SMFT-1000

Table of Contents

Power AC/DC and Function Tests	24
Single Phase Inverter Performance Check.....	24
3-Phase Inverter Performance Check.....	25
AC/DC Voltage Measurement	26
AC/DC Current Measurement.....	26
Functional Tests.....	27
Insulation Resistance Test (R_{INS})	28
Test Method 1 (Keep the Leads).....	28
Test Method 2 (Default).....	29
Continuous Measurement.....	30
Wet Insulation Resistance Test.....	31
I-V Curve Test.....	32
Additional Tests	33
Bypass Diode Test	33
Blocking Diode Test.....	35
Continuous Diode Test.....	36
Surge Protection Device (SPD) Test	38
Auto Test Sequence.....	39
Menu.....	40
Download Test Results	40
Download PV Model Data.....	41
Maintenance.....	41
Fuse Replacement	42
Battery Replacement	43
Product Disposal	44

Introduction

The Fluke SMFT-1000 Multifunction PV Analyzer (the PV Analyzer or the Product) is a battery-operated analyzer for installation testing and periodic inspection of mains-coupled photovoltaic (PV) systems. [Table 1](#) is a list of the main functions.

Table 1. Functions

Function	Includes
Category 1 test regime	Visual inspection checklist
	Protective conductor resistance (R_{LO}) measurement with a testing current ≥ 200 mA (@2 Ω)
	Polarity check with automatic display of the voltage polarity and acoustic/visual warning for wrong polarity
	Open-circuit voltage (V_{OC}) measurement at the PV model/string with up to 1000 V dc
	Short-circuit (I_{SC}) current measurement at the PV model/string with up to 20 A dc
	Insulating resistance (R_{INS}) measurement with a testing voltage of 50 V, 100 V, 250 V, 500 V, 1000 V
	Blocking diode measurement (V_{BD}) with Method 1 and Method 2 (IEC 62446-1)
	Bypass diode measurement of panel when covered or in darkness
	Surge protection device (SPD)
Functional test	Power measurements on DC and AC side to check efficiency
	Voltage DC/AC measurement
	Current DC/AC measurement with clamp adapter i100
	Functional test checklist
Category 2 test regime	Solar panel string I-V curve test that includes Solar PV I-V curve tracing and associated software for analysis, reporting, and certification and includes I-V curve analysis and reporting features
Long-term monitoring of insulation errors (non-direct wet insulation test) and 24-hour periodical measurement of R_{INS} (adjustable time period)	
Computer software - download, upload, review, analyze, and print test results	
Communication with remote sensor (solar irradiation, inclination, temperature)	
Communication with computer	

Contact Fluke

Fluke Corporation operates worldwide. For local contact information, go to our website:
www.fluke.com

To register your product, or to view, print, or download the latest manual or manual supplement, go to our website: www.fluke.com/productinfo

Fluke Corporation	Fluke Europe B.V.
P.O. Box 9090	P.O. Box 1186
Everett WA 98206-9090	5602 BD Eindhoven
U.S.A.	The Netherlands

+1-425-446-5500 fluke-info@fluke.com

Safety Information

General Safety Information is in the printed Safety Information document that ships with the Product and at www.fluke.com/productinfo. More specific safety information is listed where applicable.

A **Warning** identifies hazardous conditions and procedures that are dangerous to the user. A **Caution** identifies conditions and procedures that can cause damage to the Product or the equipment under test.

Specifications

Maximum voltage between any Terminal and Earth Ground	1000 V dc
Maximum differential voltage between Red and Blue terminals	700 V ac
Size (L x W x H)	10.0 cm x 25.0 cm x 12.5 cm (3.8 in x 9.8 in x 4.9 in)
Weight with batteries	1.4 kg (3.09 lb)
Battery	6 x AA Alkaline IEC LR6
Battery Life	up to 1000 measurements
Fuse	F2: FF 630 mA, 1000 V, IR 30 kA 6.3 x 32 mm F1: gPV DC 1000 V, 20 A, IR 30 kA (L/R= 2 ms), 10 mm x 38 mm
Temperature	
Operating	0 °C to 50 °C (32 °F to 122 °F)
Storage	-30 °C to 60 °C (-22 °F to 140 °F) batteries removed
Relative Humidity	up to 80 %
Altitude	
Operating	2000 m
Storage	12 000 m

Vibration MIL-PRF-28800F: Class 2

Ingress Protection IEC 60529:IP40

Computer Interface IR (serial) and Bluetooth

Wireless connection compatibility IRR2-BT

Accuracy

The accuracy specification is defined as \pm (% reading + digit counts) at 23 °C \pm 5 °C, \leq 80 % RH.
The accuracy specification for 0 °C to 18 °C and 28 °C to 50 °C: 0.1 x (accuracy specification) for each °C.

Protective Conductor Resistance R_{LO}

Display Range	Measurement Range	Resolution	Accuracy
0.00 Ω to 19.99 Ω	0.20 Ω to 19.99 Ω	0.01 Ω	\pm (2 % + 2 Digit)
20.0 Ω to 199.9 Ω	20.0 Ω to 199.9 Ω	0.1 Ω	\pm (2 % + 2 Digit)
200 Ω to 2000 Ω	200 Ω to 2000 Ω	1 Ω	\pm (5 % + 2 Digit)
Test current	\geq 200 mA (\leq 2 Ω + R_{COMP}) ^[1]		
Test voltage	4 V _{DC} to 10 V _{DC}		
Polarity reversing	Yes		
Test lead zero (Rcomp)	up to 3 Ω		
Live circuit detection	Inhibits test if terminal voltage >50 V ac/dc (typical) detected prior to initiation of test.		
[1] The number of 200 mA @ 0.1 Ω continuity tests with a set of new batteries is >1000.			

PV Model/PV String, Open-Circuit Voltage, (V_{OC})

Display Range	Measurement Range	Resolution	Accuracy
0.0 V to 99.9 V	5.0 V to 99.9 V	0.1 V	\pm (0.5 % + 2 Digit)
100 V to 1000 V	100 V to 1000 V	1 V	
Polarity test	Yes		
Live circuit detection	Inhibits test if terminal voltage >5 V ac detected prior to initiation of test.		

PV Model/PV String, Short-Circuit Current, (I_{SC})

Display Range	Measurement Range	Resolution	Accuracy
0.0 A to 20.0 A	0.2 A to 20.0 A	0.1 A	\pm (1 % + 2 Digit)
Live circuit detection	Inhibits test if terminal voltage >5 V ac (typical) detected prior to initiation of test.		

Insulation Resistance R_{INS}

Display Range	Measurement Range	Resolution	Accuracy
0.00 M Ω to 99.99 M Ω	0.20 M Ω to 99.99 M Ω	0.01 M Ω	\pm (5 % + 5 Digit)
100.0 M Ω to 199.9 M Ω	100.0 M Ω to 199.9 M Ω	0.1 M Ω	\pm (10 % + 5 Digit)
200 M Ω to 999 M Ω	200 M Ω to 999 M Ω	1 M Ω	\pm (20 % + 5 Digit)
Test voltage @ no load	50 V / 100 V / 250 V up to 199.9 M Ω	1 V	0 % to + 25 %
	500 V / 1000 V up to 999 M Ω		
Testing current	Min. 1 mA (@ 250 k Ω / 500 k Ω / 1 M Ω)		
	Max. 1.5 mA (short circuit)		
Live circuit detection	Inhibits test if terminal voltage >15 V ac (typical) detected prior to initiation of test.		
Maximum capacitive load	Operable with up to 2 μ F at 1M Ω		
<i>Note</i>			
<i>The number of insulation tests with a new set of batteries is >900 at 1000V / 1 MΩ.</i>			

Blocking Diode Check (V_{BD})

Display Range	Measurement Range	Resolution	Accuracy
0.00 V dc to 6.00 V dc	0.50 V dc to 6.00 V dc	0.01 V dc	\pm (5 % + 10 Digit)
Live circuit detection	Inhibits test if terminal voltage >50 V ac/dc (typical) detected prior to initiation of test.		

Surge Protection Devices (SPD)

Display Range	Measurement Range	Resolution	Accuracy
0 V dc to 1000 V dc	50 V dc to 1000 V dc	1 V dc	\pm (10 % + 5 Digit)
Live circuit detection	Inhibits test if terminal voltage >50 V ac/dc (typical) detected prior to initiation of test.		

True-rms AC V, DC V, AC A, DC A

The PV Analyzer measures both ac and dc signal components (voltage or current) and displays AC+DC (rms) value combined. The display of ac or dc unit is dependent on if there is zero crossing of the signal.

AC/DC Voltage Measurement with 4 mm Test Sockets

Display Range	Measurement Range	Resolution	Accuracy (DC, AC 50 Hz/60 Hz)
0.0 V ac to 99.9 V ac	5.0 V ac to 99.9 V ac	0.1 V	\pm (2.5 % + 2 Digit)
100 V ac to 700 V ac	100 V ac to 700 V ac	1 V	
0.0 V dc to 99.9 V dc	5.0 V dc to 99.9 V dc	0.1 V	
100 V dc to 1000 V dc	100 V dc to 1000 V dc	1 V	
Detection ac/dc	Yes (Automatic)		
Positive / negative polarity check	Yes		

AC/DC Current with i100 Clamp

Display Range	Measurement Range	Resolution	Accuracy (DC, AC 50 Hz/60 Hz)
0.0 A dc to 100 A dc	1.0 A dc to 100 A dc	0.1 A	± (5 % + 2 Digit) ^[1]
0.0 A ac to 100 A ac TRMS	1.0 A ac to 100 A ac TRMS		
[1] i100 clamp tolerance not inclusive. See <i>i100 Clamp Tolerances</i> .			

i100 Clamp Tolerances

Measurement Range	Output Signal	Accuracy (DC, AC 50 Hz/60 Hz)	Maximum Hysteresis
1 A to 100 dc or ac <1 kHz	10 mV/A ac/dc	± (1.5 % + 0.5 A)	±0.4 A

AC/DC Power Measurement (with i100 Clamp)

Display Range	Measurement Range	Resolution	Accuracy (DC, AC 50 Hz/60 Hz)
0.0 V ac to 700 V ac	5.0 V ac to 700 V ac	0.1 V	± (2.5 % + 2 Digit)
0.0 V dc to 1000 V dc	5.0 V dc to 1000 V dc		
0.0 A ac/dc to 100 A ac/dc	1.0 A ac/dc to 100 A ac/dc	0.1 A	± (5 % + 6 Digit)
0 W/VA to 100 kW/kVA	5 W/VA to 100 kW/kVA	1 W / VA; 1 kW / kVA	± (7.5 % VI + 0.6 V + 0.2 I)

Safety

SMFT-1000	IEC 61010-1 Pollution Degree 2 IEC 61010-2-034 CAT III 1000 V dc, CAT III 700 V ac
i100 Current Clamp	IEC 61010-2-032, Type D (for insulated conductors), 1000 V
Accessories.....	IEC 61010-031
TL1000-MC4.....	CAT III 1500 V, 20 A
TP1000 Remote Probe	
with cap.....	CAT IV 600 V, CAT III 1000 V, 10 A
without cap.....	CAT II 1000 V, 10 A
TL1000 Test Leads.....	CAT III 1000 V, 10 A
TL1000/30M Test Lead.....	CAT III 1000 V, CAT IV 600 V, 5 A (on reel) 10 A (fully extended)
TP74 Test Probes	
with cap.....	CAT IV 600 V, CAT III 1000 V, 10 A
without cap.....	CAT II 1000 V, 10 A
AC285 Alligator Clips	CAT III 1000 V, 10 A

Performance IEC 61557-1, IEC 61557-2, IEC 61557-4, IEC 61557-10

Electromagnetic Compatibility (EMC)

International IEC 61326-1: Portable Electromagnetic Environment,
CISPR 11: Group 1, Class A

Group 1: Equipment has intentionally generated and/or uses conductively-coupled radio frequency energy that is necessary for the internal function of the equipment itself.

Class A: Equipment is suitable for use in all establishments other than domestic and those directly connected to a low-voltage power supply network that supplies buildings used for domestic purposes. There may be potential difficulties in ensuring electromagnetic compatibility in other environments due to conducted and radiated disturbances.

Caution: This equipment is not intended for use in residential environments and may not provide adequate protection to radio reception in such environments.

Korea (KCC) Class A Equipment (Industrial Broadcasting & Communication Equipment)

Class A: Equipment meets requirements for industrial electromagnetic wave equipment and the seller or user should take notice of it. This equipment is intended for use in business environments and not to be used in homes.

USA (FCC)..... 47 CFR 15 subpart B.

Intentional Radiators: This device complies with part 15 of the FCC Rules. Operation is subject to the following two conditions: (1) This device may not cause harmful interference, and (2) this device must accept any interference received, including interference that may cause undesired operation. (15.19). Changes or modifications not expressly approved by Fluke could void the user's authority to operate the equipment. (15.21)

Wireless Radio Module

Frequency Range 2.402 GHz to 2.480 GHz

Output Power 8 dBm

SIMPLIFIED EU DECLARATION OF CONFORMITY

Hereby, Fluke declares that the radio equipment contained in this Product is in compliance with Directive 2014/53/EU. The full text of the EU declaration is available at the following Internet address:
<http://www.fluke.com/red>.

Before you Start

This section is general information about the contents of the kit and how to familiarize yourself with the controls and display of the PV Analyzer.

Kit Contents

Table 2 is a list of the contents in your kit.

Table 2. Kit Contents



Item	Description
1	FlukePack30 Professional Tool Backpack
2	SMFT-1000 Multifunction PV Analyzer
3	IRR2-BT Wireless Solar Irradiance Meter
4	i100 AC/DC Current Clamp 100 A

Table 2. Kit Contents (cont.)

Item	Description
5	MB1-IRR Panel Mounting Bracket (for Irradiance Meter)
6	Zero Adapter
7	80PR-IRR External Temperature Probe
8	TPAK Magnet Set
9	Carry Strap (for SMFT-1000)
10	Carry Case (for Irradiance Meter)
11	TP1000 Test Probe with Remote Test Button
12	TL1000-MC4 Test Lead Set (Male and Female)
13	Coupler Set
14	Fuse Pack
15	TL1000/30M 30 m Test Lead on Reel
16	TL1000-KIT Test Lead Kit
17	IR Optical-to-USB Adapter Cable
not shown	6 x AA Alkaline IEC LR6 (for SMFT-1000, not installed) 4 x AA Alkaline IEC LR6 (for IRR2-BT, not installed) 2 x AA Alkaline IEC LR6 (for i100, not installed)

Accessories

For the most up-to-date information on accessories, go to www.fluke.com.

How to Use the Rotary Dial

Use the rotary dial to select the test type. See [Table 3](#).

Table 3. Rotary Dial

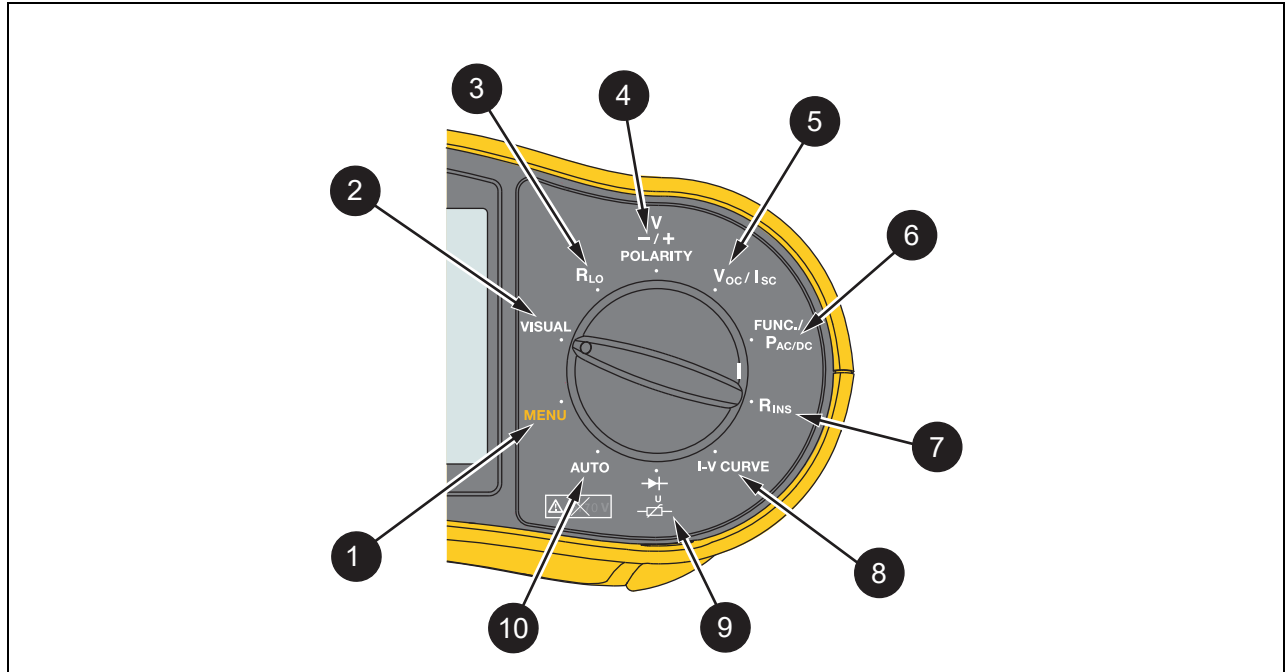



Item	Position	Description
1	MENU	Memory for saved measurements, device settings, and Help information
2	VISUAL	Checklist for pre-inspection tests
3	R_{Lo}	Continuity of equipotential bonding conductors and lightning protection conductor wiring
4	V -/+ POLARITY	Polarity test
5	V_{OC}/I_{SC}	Open circuit voltage/short circuit current
6	FUNC./$P_{AC/DC}$	Power, voltage, current and functional checklist
7	R_{INS}	Insulation resistance
8	I-V CURVE	Graph of V_{OC} tests for the maximum voltage and I_{SC} tests for the maximum current that a solar panel produces with standard test conditions
9		Blocking/bypass Diode and Surge Protection Device (SPD)
10	AUTO	Automated Testing Sequence

Buttons

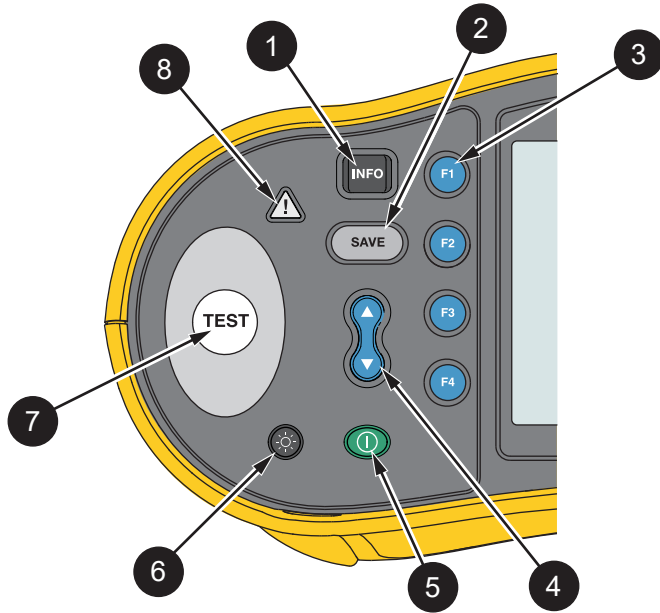

Use the buttons to control operation of the PV Analyzer, select test results to view, and scroll through selected test results. See [Table 4](#).

Table 4. Push Buttons



Item	Button	Description
1	INFO	Shows illustrations and instructions for setup and test function based on rotary dial position.
2	SAVE	Save
3	F1 F2 F3 F4	Function selection
4	Up/Down arrow	Use the up/down button to select features on the display. See specific test instructions for more information.
5	Power	Power on/off
6	Backlight	Backlight on/off and intensity. Continuously push  to cycle through the intensity levels.
7	TEST	Start the selected test
8	Warning triangle	Voltage warning

Info Button





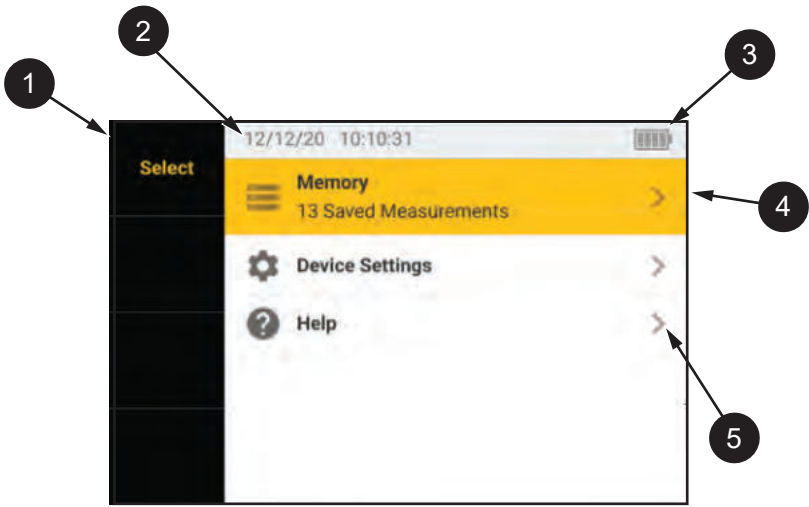

The INFO button  shows information about how to use each function of the PV Analyzer. As the rotary dial moves to a function, push  to see connection drawings and tips about the test function on the display. If a scroll bar shows on the right side of the display, use  to show more information about the test function.

Display

Table 5 is an example of the display and components.

Table 5. Display



Item	Component	Description
1	Navigation	Shows the options for    
2	Date/Time Stamp	Date and time.
3	Battery Status	Shows the status of battery power
4	Menu	Selected function is highlighted. Use  to change the selection. Push  to open the options for the selection.
5	Menu Options	Shows the options available to setup or adjust. Push  to exit the Menu Options.

Terminals/Test Leads

Test leads are connected and stay in place (Keep the Leads) throughout the test. [Table 6](#) shows the input terminals.

⚠️⚠️ Warning

To prevent possible electrical shock, fire, or personal injury, do not use test leads in CAT III or CAT IV environments without the protective cap installed. The protective cap decreases the exposed probe metal to <4 mm. This decreases the possibility of arc flash from short circuits.

Table 6. Terminals

Item	Description
①	Red Socket (PV [+] V input)
②	Blue Socket (PV [-] COM input)
③	Green Socket (Earth)
④	Yellow Socket (R_{PE} , Clamp input common)
⑤	IR Data Port

The IR (infrared) port allows you to connect the Tester to a computer and download the test data with *TruTest™ Data Management Software* documentation. With this software, you can collect, organize, and display the test data. See [Download Test Results](#) for additional information on using the IR port.

Error Messages

When the Analyzer detects error conditions, the display shows  and an error code. See [Table 7](#). These error conditions disable or stop the test.

Tip: Push **INFO** for instructions about the error message.

Table 7. Error Codes

Error Code	Test Type	Description
1.1	Pre-test Automatic	Irregular voltage detected between inputs green and yellow $V \geq 50.0 \text{ V}$
1.2	Pre-test Automatic	Irregular voltage detected between inputs red and blue $V \geq 1020 \text{ V}$, V_{AB} Polarity: MINUS or AC (when $V \geq 5.0 \text{ V}$)
1.3	Pre-test Automatic	Irregular voltage detected between inputs blue and yellow $V \geq 30.0 \text{ V}$
1.4	Pre-test Automatic	Short circuit current overload $I_{SC} \geq 20.5 \text{ A}$
1.5	Pre-test Automatic	Irregular voltage detected between inputs red and green (or blue and green) $V \geq 50.0 \text{ V}$
1.6	Pre-test Automatic	Irregular voltage detected between inputs red and blue $V \geq 1020 \text{ V DC}$, $\geq 720 \text{ V AC}$, MINUS (when $V \geq 5.0 \text{ V}$)
1.7	Pre-test Automatic	Irregular voltage detected between inputs green and yellow $V \geq 720.0 \text{ V}$
2.1	Automatic Test	Overheating (over-temperature)
3.1	Automatic Test	Memory overload
4.1	Test Post-test	Fuse F1 Failed Internal test indicates that the safety fuse (20 A) is open. F1 fuse replacement must be done by a qualified technician.
4.2	Test Post-test	Fuse F2 Failed Internal test indicates that the safety fuse (0.63 A) is open and needs to be replaced to do this measurement. See Fuse Replacement .
4.3	Test Post-test	Fuse F1 and F2 Failed Internal test indicates that both safety fuses (20 A and 0.63 A) are open and need to be replaced to do this measurement. F1 fuse replacement must be done by a qualified technician.

How to Zero the Test Leads

⚠️⚠️ Warning

To prevent possible electrical shock, fire, or personal injury, do not use in CAT III or CAT IV environments without the protective cap installed. The protective cap decreases the exposed probe metal to <4 mm. This decreases the possibility of arc flash from short circuits.

When you measure the Continuity (R_{Lo}) of equipotential bonding conductors and lightning protection conductor wiring, the test leads have a small amount of inherent resistance that can affect a measurement. Before you do a continuity test, use the zero adapter to compensate for, or zero, the test leads. See [Figure 1](#).

Figure 1. Zero Adapter Configuration

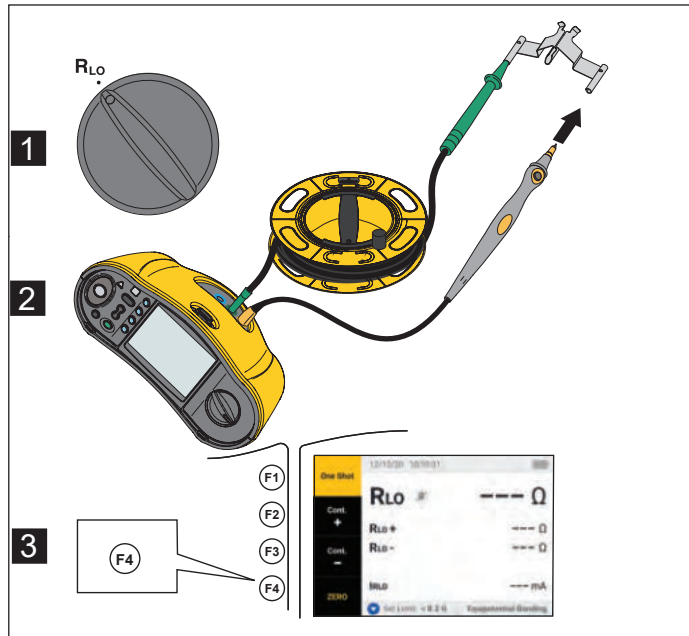

Test Setup

Use this kit for safety and performance analysis of solar systems according to IEC 62446-1. The kit contains the SMFT-1000 PV Analyzer (PV Analyzer) and the IRR2-BT Irradiance Meter (Irradiance Meter).

The PV Analyzer provides safety and performance measurements of the solar system.

The Irradiance Meter provides auxiliary data of sun irradiance and solar panel temperature. This data complements the IV Curve Solar Panel performance measurements on the PV Analyzer. The IRR2-BT sends the data to the PV Analyzer wirelessly. If wireless connection is interrupted for any reason, the Irradiance Meter automatically records the data that is later transferred when the connection is reestablished. Both devices have synchronized clocks to properly match the data.

Note

Before taking IV Curve performance measurements, synchronize the PV Analyzer and Irradiance Meter via wireless connection. See [Pair PV Analyzer to the Irradiance Meter](#).

To power on the PV Analyzer:





1. Push  for 1 s. to turn on the PV Analyzer.

The displays shows a startup screen with the firmware version.

2. Push  for 2 s. to turn off the PV Analyzer.

Pair PV Analyzer to the Irradiance Meter

For first time use, you must pair the PV Analyzer Analyzer with the Irradiance Meter:

1. Turn on the PV Analyzer and the Irradiance Meter.
2. Make sure the PV Analyzer and the Irradiance Meter are within the wireless range (<50 m) of each other.
3. Turn the rotary dial to **MENU**.
4. Use  to highlight **Device Settings**.
5. Push  to open the Device Settings menu.
6. Use  to highlight **Irradiance Meter Pairing**.
7. Push .
8. Follow the on-screen directions on the PV Analyzer to pair the devices.

 shows on the PV Analyzer display to indicate that the PV Analyzer and Irradiance Meter are connected.

After the initial setup, the PV Analyzer pairs with the IRR2-BT when you turn on both devices and are within the wireless range (<50 m).

For IV Curve measurements, synchronize the PV Analyzer with the IRR2-BT at the start of the work day:

1. Turn on the PV Analyzer and the Irradiance Meter.
2. Make sure the PV Analyzer and the Irradiance Meter are within the wireless range (<50 m) of each other.
3. On the PV Analyzer, turn the rotary switch to **I-V CURVE**.
4. Press **(F4)**.
5. Follow the on-screen directions on the PV Analyzer to synchronize both devices.

 shows on the PV Analyzer display to indicate that the PV Analyzer and the Irradiance Meter are connected.

During synchronization, the PV Analyzer matches all the data from the Irradiance Meter to the recordings on the PV Analyzer from the previous sessions. The real-time clocks on both devices synchronize and the Irradiance Meter clears its memory. The Irradiance Meter continuously records data for up to 17 hours.

An option to manually enter irradiance and temperature measurements is available. For more information, see [I-V Curve Test](#).

Note

If the Irradiance Meter is installed on the panel, move the PV Analyzer within the wireless range.

IEC 62446-1 Category 1 Tests

Visual Inspection

IEC regulations require a visual inspection of the Solar System. The PV Analyzer provides a checklist with each task and then records and saves the results of the visual inspection to the internal memory. All results can be downloaded to the PC software and used for final reports.

To do a visual inspection:

1. Turn on the PV Analyzer.
2. Turn the rotary switch to **VISUAL** and follow the on-screen prompts.
3. If a scroll bar shows on the right side of the display, use  to show more information about the checklist.
4. Use **(F1)** **(F2)** or **(F3)** to select a result.
5. Push **(SAVE)** to store results to memory.

A confirmation message shows on the display.

Continuity of Protective Earthing and Equipotential Bonding Conductors

For accurate measurements, always compensate the resistance of the test leads before you make measurements:

1. Turn on the PV Analyzer.
2. Turn the rotary switch to **R_{Lo}**.
3. Zero (short) the green lead and yellow lead.
4. Push **(F4)**.

For more information, see [Figure 1](#).

5. Follow the on-screen prompts.
6. To assign Pass or Failed status, set the regulatory limits for the measurements.

Note

You cannot change the limits after the measurement is taken. If you change the limit, you must repeat the measurement.

Set Limits

The regulatory limit is based on the length of the cable used in the test.

To set:

1. Turn on the PV Analyzer.
2. Turn the rotary switch to **R_{Lo}**.
3. Use **(F1)** **(F2)** **(F3)** or **(F4)** to highlight an option.
4. Push **▼** to edit the option.

The Manual Entry screen shows on the display.

5. Push **(F1)** to open the Adjustment menu.
6. Use **↕** to change the value.
7. Adjust the Cross Section and Material options as required.
8. Push **(F3)** to toggle between the Manual Entry screen and Auto Calculate limit.
9. Push **(F4)** to save the calculation and return to the **R_{Lo}** Measurement screen.

Resistance Test (R_{LO})

The PV Analyzer measures protective conductor resistance (R_{LO}) with a test current ≥ 200 mA (@2 Ω) for:

- Earthing and Equipotential Bonding Conductors to IEC 62446-1 Clause 6.1
- Lightning Protection System (LPS)
- Grounding System

Resistance of Earthing and Equipotential Bonding Conductors

To measure the resistance of earthing and equipotential bonding conductors:

1. Turn the rotary switch to R_{LO} .
2. Use ▼ to select **Equipotential Bonding**.
3. Push (F1) to select **One Shot** (default mode) and follow the on-screen prompts.
4. Connect the green test lead to the central PE connector / ground.
5. Connect the yellow test lead to the measurement point.

This could be the metal frame of the module or the rails of the solar mounting system.

6. Push (TEST) either on the PV Analyzer or on the Remote Probe.

In this mode the PV Analyzer does a short measurement (R_{LO+}) followed by a second short measurement (R_{LO-}) with reversed polarity.

The PV Analyzer shows both results when the measurement is complete and selects the highest measurement (worst) as the main result. Based on the chosen limit, all three results are determined as PASS or FAIL.

The PV Analyzer also shows the value of the test current applied during the resistance test (I_{RLO}).

Lightning Protection Conductor Wiring

To measure resistance in Lightning Protection System (LPS):

1. Turn the rotary switch to the R_{LO} position.
2. Use ▼ to select **Lightning Protection Conductor**.
3. Push (F4) to select **One Shot** (default mode) and follow the on-screen prompts.

In this mode the PV Analyzer does a short measurement (R_{LO+}) followed by a second short measurement (R_{LO-}) with reversed polarity. The PV Analyzer shows both results when the measurement is complete and selects the highest measurement (worst) as the main result. Based on the chosen limit, all three results are determined as PASS or FAIL.

Grounding System

To troubleshoot the grounding system with the **R_{Lo}** Continuous Measurement method:

1. Push **F2** for **R+ Positive** or **F3** for **R- Negative** and follow the on-screen prompts.

Polarity Test

The polarity test verifies to IEC 62446-1 Clause 6.2 that the positive and negative wires are correctly connected to the solar system combiner box, inverter, or switch gear.

Warning



To prevent personal injury or damage to the system, all connections must use the correct polarity.

To test polarity:

1. Turn the rotary switch to **-/+ POLARITY**.
2. Connect the red test lead to the positive connector of the PV string and the blue test lead to the negative connector of the PV string.

Tip: Push **INFO** to see the connection diagram.

3. Follow the on-screen prompts.

The upper display shows the actual voltage connected to the test leads. For voltages >5 V the PV Analyzer determines the measurements as  or . All positive voltage show as **PASS** and all negative voltages as **FAIL**.

If ac voltage is detected, a warning shows on the display.

PV String Combiner Box

This test procedure verifies to IEC 62446-1 Clause 6.3. Do this test before any string fuses or connectors are connected for the first time:

- Connect all negative fuses or connectors so strings share a common negative bus.
- Do not connect any positive fuses or connectors.
- Measure the open circuit voltage of the first string, positive (red test lead) to negative (blue test lead), and assure that it is an expected value.
- Continue with subsequent strings, positive to negative, and assure that it is the expected value and do not differ more than ± 15 V from the strings previously measured.

To test string fuses:

1. Turn the rotary switch to **-/+ POLARITY**.
2. Push **INFO** to see the connection diagram.
3. Follow the on-screen prompts.

PV String

Open circuit voltage measurement and circuit current test (short circuit test or operational).

Open Circuit Voltage Measurement (V_{OC})

Open circuit voltage (V_{OC}) measurement to IEC 62446-1 Clause 6.4. This test checks that module strings are correctly wired and that the expected number of modules are connected in series within the string. For strings connected in series, the measured voltage should be a sum of the voltages of individual solar panels in the string. This test can also be used to verify open voltage of the individual panel.

Circuit Current Test - Short Circuit Test (I_{SC})

The PV string circuit current test to IEC 62446-1 Clause 6.5.2 is a short-current measurement test to verify the correct operational characteristics of the system and that no major faults are within the PV array wiring. These tests are not to be taken as a measure of module / array performance. Compare the results of the short-current measurement with solar panel specifications. The PV Analyzer does all calculations automatically if solar panel specifications are linked and Irradiance/Temperature measurements are transferred from the Irradiance Meter.

Operational Test Method

Alternative test method for I_{SC} (see IEC 62446-1 Clause 6.5.3).

To test:

1. Download the panel specifications.
2. Select PV model.
3. Enter the number of modules for each string.
4. Install Irradiance Meter at the solar panel to test.
5. Turn the rotary switch to V_{OC}/I_{SC} .
6. Connect the red test lead to positive connector of string and the blue test lead to negative connector of string.

Tip: Push  to see connection diagram.

7. Follow the on-screen prompts.

The PV Analyzer determines the results for open circuit voltage measurement and short circuit test as PASS or FAIL based on the chosen PV model panel data and number of modules.

Voltage/Current Test (V_{OC}/I_{SC})

The V_{OC} is a test to IEC 62446-1 Clause 6.4 for the maximum voltage that the solar panel produces in standard test conditions. The I_{SC} is a test to IEC 62446-1 Clause 6.5.2 for the maximum current that the solar panel produces in standard test conditions.

To test:



1. Install the Irradiance Meter at the solar panel to test.
2. Turn the rotary switch on the PV Analyzer to the **V_{OC}/I_{SC}** position.
3. Set the limit for V_{OC} based on data from Irradiance Meter and PV model.
STC calculation limits: calculated from irradiance and nominal values.
4. Set the limit for I_{SC} based on data from Irradiance Meter and PV model.
STC calculation limits: calculated from irradiance and nominal values.
Irr & Tcell data from the Irradiance Meter shows on the display.
5. Connect the red test lead to positive connector of string and the blue test lead to negative connector of string.

Tip: Push  to see a connection diagram.

The V_{OC} measurement shows on the display after you connect the test leads.

Note

If the PV Analyzer detects reverse polarity, you will hear an audible beep and the display shows a warning for a failed test due to a negative measurement.

6. Push  to start the I_{SC} measurement.
The V_{OC} and I_{SC} results show on the display with a Pass/Fail icon based on the limit from the Irradiance Meter.
7. Push  to save the results to memory.

A confirmation message with ID number shows on the display and then returns to the test screen.

Select PV Model

When the Irradiance Meter is not connected, no limits are available and no irradiance or temperature data shows on the display.

To take a measurement:

1. Connect the test leads from the PV Analyzer to the solar panel.

Tip: Push  to see a connection diagram.

The V_{OC} measurement shows on the display after you connect the test leads. The Pass/Fail icons do not show in this configuration.

2. Push  to start the I_{SC} measurement.

The V_{OC} and I_{SC} results show on the display.

3. Push  to save the results to memory.

A confirmation message with ID number shows on the display and then returns to the test screen.

Paired with Irradiance Meter Only

When the Irradiance Meter is connected and a PV model is not selected, no limits are available. The irradiance and temperature data from the Irradiance Meter shows on the display.

To take a measurement:

1. Connect the test leads from the PV Analyzer to the solar panel. The V_{OC} measurement automatically shows on the display.

Tip: Push  to see a connection diagram.

The V_{OC} measurement shows on the display after you connect the test leads. Irr & Tcell data from the Irradiance Meter shows on the display. The Pass/Fail icons do not show in this configuration.

2. Push  to start the I_{SC} measurement.

The V_{OC} and I_{SC} results show on the display.

3. Push  to save the results to memory.

A confirmation message with ID number shows on the display and then returns to the test screen.

Quick V_{OC}/I_{SC} Measurement

You can take a quick V_{OC}/I_{SC} measurement without connecting the Irradiance Meter or PV model. Pass/Fail limits or Irradiance data do not show with this type of measurement.

To take a measurement:

1. Turn the rotary switch on the PV Analyzer to V_{OC}/I_{SC} .
2. Connect the test leads to the solar panel. The V_{OC} measurement automatically shows on the display.

Tip: Push  to see a connection diagram.

Voltage symbol is on when voltage is ≥ 50 V.

3. Push  to start the I_{SC} measurement.

The V_{OC} and I_{SC} results show on the display. The Pass/Fail icons do not show in this configuration.

4. Push  to save the results to memory.

A confirmation message with ID number shows on the display and then returns to the test screen.

V_{OC} /Operational Current Measurement

Operational current as alternative method for I_{SC} as required by IEC 62446-1 Clause 6.5.3.

To take a measurement:

1. Connect the PV string to the inverter and switch the system to on and normal operation mode (inverter must be at maximum power point).

It is useful to connect two Y-connectors in between so you can measure the string voltage in parallel.

2. Turn the rotary switch to V_{OC}/I_{SC} .
3. Connect the test leads to the solar panel.

The V_{OC} measurement automatically shows on the display.

Tip: Push  to see a connection diagram.

4. Push  to start the V_{OC} measurement.

The V_{OC} measurement shows on the display. If the PV model is selected and the Irradiance Meter is connected, the Pass/Fail icons show on the display. The Measure V_{OC} instructions are grayed-out with a checkmark to indicate that the measurement is done. The Measure Operational Current instructions become enabled/brighter.

5. Connect the Clamp and make sure the current flow/polarity matches with the arrow on the Clamp.

Tip: Push  to see a connection diagram.

6. Push  to start the Operational Current measurement.

Power AC/DC and Function Tests

Tests the power output from the PV system to make sure that the dc power produced by the panels is inverted properly into ac power as required by IEC 62446-1 Clause 6.6.

Single Phase Inverter Performance Check

Measure the dc power, then ac power, then compare efficiency.



To make a dc measurement:

1. Turn the rotary switch on the PV Analyzer to **FUNC./P_{AC/DC}**.

The display shows power in the blank state and is ready to compare the dc and ac measurements.

2. Push  to set the Efficiency Factor Limit.
3. Connect the PV string to the inverter and switch the system to on and normal operation mode (the inverter has to be at maximum power point).
4. Connect the red test lead in parallel to the positive connector of the PV string and the blue test lead in parallel to the negative connector of the PV string to the solar panel.
5. Connect the Clamp and make sure the current flow/polarity matches with the arrow on the Clamp.

Tip: Push  to see a connection diagram.

6. Push .
7. Push  to hold the dc measurements.



The blue column header indicates that the dc measurements are on hold.

8. Push ▼ to clear or cancel the dc measurement column and return to the blank state.

To make an ac measurement:

1. Connect the test leads to the ac output of the inverter.
2. Connect the Clamp.

Tip: Push  to see a connection diagram.

3. Push .
4. Push  to hold the ac measurements.

The blue column header indicates that the ac measurements are on hold.

The display shows the Efficiency Factor ratio with a Pass or Fail icon.

5. Push  to save the results to memory.

A confirmation message with ID number shows on the display and then returns to the test screen.



3-Phase Inverter Performance Check

Measure the dc power, then ac power (L1 + L2 + L3), then compare efficiency.



To make a measurement:

1. Turn the rotary switch on the PV Analyzer to **FUNC./P_{AC/DC}**.



The display shows power in the blank state and is ready to check the 3-phase power.

2. Push ▲ to toggle between Single Phase and 3 Phase power.
3. Push ▼ to set the Efficiency Factor Limit.
4. Push .
5. Push  to hold the dc measurements.

The blue column header indicates that the dc measurements are on hold.

6. Push .
7. Push  to hold the ac-L1 measurements.

The blue column header indicates that the ac-L1 measurements are on hold.

8. Push .
9. Push  to hold the ac-L2 measurements.

The blue column header indicates that the ac-L2 measurements are on hold.

10. Push .

11. Push  to hold the ac-L3 measurements.

The blue column header indicates that the ac-L3 measurements are on hold.

The display shows the Efficiency Factor ratio with a Pass or Fail icon.

12. Push  to save the results to memory.

A confirmation message with ID number shows on the display and then returns to the test screen.

AC/DC Voltage Measurement

Single-shot voltage measurement that automatically detects ac or dc power.

To make a measurement:

1. Turn the rotary switch on the PV Analyzer to **FUNC./P_{AC/DC}**.

2. Push  to measure the voltage.

The dashes on the display indicate that no leads are connected to the PV Analyzer.

3. Connect the test leads to the circuit under test.

Tip: Push  to see a connection diagram.

The PV Analyzer automatically detects if the measurement is ac or dc voltage.

4. Push  to hold the measurement.

The measurement is on hold.

5. Push  to save the results to memory.

A confirmation message with ID number shows on the display and then returns to the test screen.

AC/DC Current Measurement

Single-shot current measurement that automatically detects ac or dc power.

To make a measurement:

1. Turn the rotary switch on the PV Analyzer to **FUNC./P_{AC/DC}**.

2. Toggle  to measure the current.

The  button toggles the selection between a voltage or current measurement. The dashes on the display indicate that no leads are connected to the PV Analyzer.

3. Connect the clamp to the circuit under test.

Tip: Push  to see a connection diagram.

The PV Analyzer automatically detects if the measurement is ac or dc current.

4. Push  to hold the measurement.

The measurement is on hold.





5. Push  to save the results to memory.

A confirmation message with ID number shows on the display and then returns to the test screen.

Functional Tests

Checklist of functional tests.

To test:

1. Turn the rotary switch on the PV Analyzer to **FUNC./P_{AC/DC}**.
2. Push  to start to record the results of the functional tests.
3. Use  to highlight the different checklist items.
4. Push  and  to select pass, fail, or N/A for the highlighted row.
5. Push  (Back) to return to the Power test.

If any check boxes are filled in, then  is available. All results show on the display until you clear for a new session regardless of power on/off or different day.

6. Push  to save the results to memory.

A confirmation message with ID number shows on the display and then returns to the test screen.

Insulation Resistance Test (R_{INS})

The R_{INS} Mode is a test for the resistance of the insulation between the ground and the PV Array as required by IEC 62446-1 Clause 6.7. Repeat this test, as a minimum, for each PV array or sub-array. You can also test individual strings if required.

Test Method 1 (Keep the Leads)

This test is between the PV Array negative and earth followed by a test between the PV Array positive and earth. For this test, the connections do not change (Keep the Leads option).

To test:

1. Turn the rotary switch on the PV Analyzer to R_{INS} .
2. Connect the test leads to the solar panel.

Tip: Push  to see a connection diagram.

If ground-point and frames **are bonded** to earth point on site:

- a. Connect the green test lead to ground.
- b. Connect the red test lead to positive terminal on the PV Array.
- c. Connect the blue test lead to negative terminal on the PV Array.

OR

If ground-point and frames **are not bonded** to earth point on site (protection class II of installation):

- a. Connect the green test lead to PV Array frame.
 - b. Connect the red test lead to positive terminal on the PV Array.
 - c. Connect the blue test lead to negative terminal on the PV Array.
3. Use the ▼ to select the nominal test voltage (V_N selection=50/100/250/500/1000 V).

This value will trigger the limit values.

4. After leads are configured, push  >1 s. to start the R_{INS} (1) measurement.

The dashes blink during the measurement calculation and then the test results show on the display:

- R_{INS} : lowest number of $R_{INS} +$ or $R_{INS} -$
- $R_{INS} +$: insulation resistance PV+ to ground
- $R_{INS} -$: insulation resistance PV- to ground
- $V_{INS} +$: applied test voltage during the insulation test (PV+ to ground)
- $V_{INS} -$: applied test voltage during the insulation test (PV- to ground)

Passed:  and a short beep noise indicates the test passed when the results are greater than the preset limits.

Failed:  and multiple beeps indicates the test failed when the results are less than the preset limits.

5. Push  to save the results to memory.

A confirmation message with ID number shows on the display and then returns to the test screen.

Note

If the resistance is outside an acceptable threshold from the R_{INS} test (1 or 2), use the Continuous test to find the exact location on the insulation where the resistance is failing. See [Continuous Measurement](#).

Test Method 2 (Default)

The default Test Method 2 is a test between earth and the short-circuited array for a positive and then negative measurement. This method also uses the Keep the Leads option.

1. Turn the rotary switch on the PV Analyzer to **R_{INS}** .
2. Use  to select the nominal test voltage (V_N selection=50/100/250/500/1000 V).

This value will trigger the limit setting.

3. Connect the test leads to the PV Array.

Tip: Push  to see a connection diagram.

If ground-point and frames **are bonded** to earth point on site:

- a. Connect the green test lead from green socket to ground.
- b. Connect the red test lead from red socket to positive terminal on the PV Array.
- c. Connect the blue test lead from blue socket to negative terminal on the PV Array.

OR

If ground-point and frames **are not bonded** to earth point on site (protection class II of installation):

- a. Connect the green test lead from green socket to PV Array frame.
- b. Connect the red test lead from red socket to positive terminal on the PV Array.
- c. Connect the blue test lead from blue socket to negative terminal on the PV Array.

4. After leads are configured, push  to start the R_{INS} (2) measurement.

Note

The high voltage icon and dashes show during the measurement.

When complete the test results show on the display:

- R_{INS} (2): measured insulation resistance
- V_{INS} : applied test voltage during the insulation test

Passed:  and a short beep noise indicates the test passed when the results are greater than the preset limits.

Failed:  and multiple beeps indicates the test failed when the results are less than the preset limits.

5. Push  to save the results to memory.

A confirmation message with ID number shows on the display and then returns to the test screen.



Note

If the resistance is outside an acceptable threshold from the R_{INS} test (1 or 2), use the Continuous test to find the exact location on the insulation where the resistance is failing. See [Continuous Measurement](#).

Continuous Measurement

You can measure R_{INS} between any two measurement points in the PV system. This measurement helps to troubleshoot insulation faults on the wiring cables. Fluke recommends that you remove the solar modules for this test as they can influence the result.

To measure:





1. Turn the rotary switch on the PV Analyzer to **R_{INS}** .
2. Push  to enter the R_{INS} Continuous mode.
3. Use  to select the nominal test voltage (V_N selection=50/100/250/500/1000 V).

This value will trigger the limit values.

Tip: Push  to see a connection diagram.

4. After you connect the leads, push  >1 s. to start the R_{INS} Continuous measurement.

The dashes show during the measurement calculation and then the test results show on the display:

- Live Results: measurement results refresh every second.
 - Green check mark appears when result is under the limit.
5. Push  >1 s. at any time to pause and hold the measurement on the screen.
 6. Push  >1 s. again to resume measurement.
 7. Move test leads up and down the cable until you find the resistance issue:
 -  shows on the display next to measured resistance that is below the limit.
 - multiple beeps indicate the test failed.
 8. Push  to save the results to memory.

A confirmation message with ID number shows on the display and then returns to the test screen.

OR

9. Connect to the next test point (not necessary to clear if you do not save) or proceed to the next test.

Wet Insulation Resistance Test

The wet insulation resistance test meets IEC 62446-1 Clause 8.3 requirements and is best used as a fault-finding exercise. This resistance test evaluates the PV Array electrical insulation in wet operating conditions. The test simulates rain or dew on the array and wiring and then verifies that moisture will not enter active portions of the array electrical circuitry where it may enhance corrosion, cause ground faults, or pose an electrical safety hazard to personnel or equipment. This test is especially effective for finding above ground defects such as wiring damage, inadequately secured junction box covers, and other similar installation issues. It also may be used to detect manufacturing and design flaws including polymer substrate punctures, cracked junction boxes, inadequately sealed diode cases, and improper (indoor rated) connectors.

A wet insulation test would be implemented when the results of a dry test are questionable or where insulation faults due to installation or manufacturing defects are suspected.

The test is applied to a whole array or on larger systems to select parts such as components or sub-sections of the array. Where only parts of the array are being tested, these are selected due to a known or suspected problem identified during other tests. In some circumstances, the wet insulation test may be requested on a sample portion of the array.

Use the same test sequence in [Test Method 1 \(Keep the Leads\)](#) or [Test Method 2 \(Default\)](#).

I-V Curve Test

V_{OC} is a test for the maximum voltage that the solar panel can produce under standard test conditions as required by IEC 62446-1 Clause 7.2. I_{SC} is a test for the maximum current that the solar panels can produce under standard test conditions.

To measure:

1. Turn the rotary switch on the PV Analyzer to **I-V Curve**.

The I-V Curve Table shows on the display and indicates if the PV Analyzer is connected to the Irradiance Meter or PV model.

If not connected:

- a. Push **(F4) IRR Meter** to pair the Irradiance Meter with the PV Analyzer. For more information, see [Pair PV Analyzer to the Irradiance Meter](#).
- b. Push **(F3) PV Model** to select the PV model from the database.

When connected, the I-V Curve Table shows:

- Irradiance live reading from the Irradiance Meter
- Cell Temperature live reading from the Irradiance Meter
- Nominal Values based on the PV model

2. Push **(F2)** to view the I-V Curve Graph.

The I-V Curve Graph shows:

- Nominal Curve based on data from the PV model
- Area Curve shows the range of the min-to-max values of the Nominal Curve based on the Nominal values $\pm 5\%$ (Pass Criteria = 5%)

3. Connect the red test lead to the positive connector of the PV Array and the blue test lead to the negative connector of the PV Array.

Tip: Push **INFO** to see a connection diagram.

4. Attach the Irradiance Meter to the panel with the bracket.
5. Push **(TEST)** to start the measurement and create an I-V curve.



The display shows a progress bar.

6. Push **(F1)** to cancel the test.

Note

A warning shows on the display if the PV Analyzer detects reverse polarity at the start of the test. Push  to see a connection diagram.

When the test is complete, the test results show in the I-V Curve Table:

- STC column shows values
 - Pass/Fail indicators show for each row
 - MEAS (measured) column shows values
7. Push  to view a Graph display the of measured curve and STC curve on top of the NOM area curve.
 8. Use  to toggle between the two table and graph views:
 - Advanced Table View with an additional column that shows the measured values
 - Advanced Graph View shows the measured values as the black line
 9. Push  to save the results to memory.

A confirmation message with ID number shows on the display and then returns to the test screen with blank STC and MEAS data.

Note

A question-mark shows on the PV model tab as a reminder to update the PV model data if necessary.

Additional Tests

Diode tests are available to meet IEC 62446-1 Clause 8.2 requirements.

Bypass Diode Test

Bypass Diodes prevent the current flowing from good, well-exposed-to-sunlight solar cells overheating and burning out weaker or partially shaded solar cells by providing a current path around the bad cell.



To set:

1. Turn the rotary switch on the PV Analyzer to .

The display shows the Bypass Diode test mode. Push  if the Bypass Diode test mode does not show.

2. Use  to set the pass/fail limit for the bypass diode voltage measurement.

To set limit:

- a. Use  to highlight the options.
 - b. Push **(F1)** to select the highlighted option and edit on new screen.
 - c. Push **(F4)** to save the limit and return to the previous Diode Test.
 - d. Push **(F3)** to manually enter a bypass diode limit.
 - e. Use **(F1)** and **(F2)** to select the digit to edit.
 - f. Use  to change the value.
 - g. Push **(F4)** (Back) to return to the Set Limit display.
3. Connect the test leads from the PV Analyzer to the bypass diode.

Tip: Push  to see a connection diagram.

- a. Connect green test lead from the green socket to the positive anode.
- b. Connect yellow test lead from the yellow socket to the negative cathode.

 Caution

For this test the modules should not generate any voltage or power. The solar panel (DUT) must be completely shaded or in darkness.

4. Push  to start the measurement.

When the measurement is complete, the display shows:

- measured voltage of bypass diode
- measured current of bypass diode

Passed:  and a short beep indicates the test passed when greater than the preset limits.

Failed:  and multiple beeps (at a lower frequency) indicates the test failed according to preset limits.

Note

This test checks that the voltage drop of the diode is within the expected range (limit). If the voltage drop is too low the diode is shorted, if the voltage is "OL" then the diode is open.

5. Push  to save the results to memory.

A confirmation message with ID number shows on the display and then returns to the test screen.

Troubleshoot: If the voltage is not within an acceptable range, use the continuous test to find the diode that fails. See [Continuous Diode Test](#).

Blocking Diode Test

Blocking diodes ensure that the electrical current only flows in one direction "OUT" of the series array to the inverter, external load, controller, or batteries to prevent the current generated by the other parallel connected PV panels in the same array flowing back through a weaker (shaded) network and also to prevent the fully charged batteries from discharging or draining back through the array at night.

Blocking diodes can fail in both open and short circuit states. This test is important for installations where blocking diodes are fitted.

To set:

1. Turn the rotary switch on the PV Analyzer to .

The display shows the default Bypass Diode test mode.

2. Push  for the **Blocking Diode** test mode.
3. Connect the test leads from the PV Analyzer to the blocking diode.

Tip: Push  to see a connection diagram.





- a. Connect green test lead to positive anode.
- b. Connect yellow test lead to negative cathode.

Note

Blocking diodes can be measured in operational systems. There is no need to disconnect the modules or switch off the voltage/power.

4. Use  to set the pass/fail limit for the blocking diode voltage measurement.

To set limit:

- a. Use  and  to select the digit to edit.
- b. Use  to change the value.
- c. Push  (Back) to return to the blocking diode test screen.

5. Push  to start the measurement.

When the measurement is complete, the display shows:

- measured voltage of blocking diode
- measured current of blocking diode

Passed:  and a short beep noise indicate the test passed when the results are greater than the preset limits.

Failed:  and multiple beeps indicate the test failed when the results are less than the preset limits.

Note

This test checks that the voltage drop of the diode is within the expected range (limit). If the voltage drop is too low the diode is shorted, if the voltage is "OL" then the diode is open.

6. Push  to save the results to memory.

A confirmation message with ID number shows on the display and then returns to the test screen.

Troubleshoot: If the voltage is not within an acceptable range, use the continuous test to find the diode that fails. See [Continuous Diode Test](#).

Continuous Diode Test

Use the continuous diode test to test each diode of a PV cell and find the diode that fails.

To set:

1. Turn the rotary switch on the PV Analyzer to .

The display shows the default Bypass Diode test mode.

2. Push  for the **Diode** test mode.
3. Connect the test leads from the PV Analyzer to a diode inside the panel junction box or disconnected diode.

Tip: Push  to see a connection diagram.

4. Connect green test lead to positive anode.
5. Connect yellow test lead to negative cathode.

Caution

For this test the diodes must not be powered or operational.

6. Use ▼ to set the pass/fail limit for the diode voltage measurement.

To set limit:

- a. Use (F1) and (F2) to select the digit to edit.
- b. Use  to change the value.
- c. Push (F4) (Back) to return to the blocking diode test screen.

7. Push (TEST) to start the measurement.

When the measurement is complete, the display shows:

- measured voltage of diode
- measured current of diode

Passed:  and a short beep noise indicate the test passed when the results are greater than the preset limits.

Failed:  and multiple beeps indicate the test failed when the results are less than the preset limits.

Measurement results refresh every second.

Note

This test is a test that the voltage drop of the diode is within the expected range (limit). If the voltage drop is too low the diode is shorted, if the voltage is "OL" then the diode is open.

Tip: Fluke recommends that you repeat the test with reversed polarity (connect yellow test lead to positive anode and connect green test lead to negative cathode. The reading should be always "OL".

8. Push (TEST) to pause on-screen measurement.
9. Push (TEST) again to resume on-screen measurement.
10. Push (SAVE) to save the results to memory.

A confirmation message with ID number shows on the display and then returns to the test screen.

Surge Protection Device (SPD) Test

The SPD test is a check that the device under test (DUT) works as expected.

To set:

1. Turn the rotary switch on the PV Analyzer to .

The display shows the default Bypass Diode test mode.

2. Push **(F4)** for the **SPD** test mode.

The display shows blank measurements.

3. Use **▼** to open the **Set Limit** menu and set the pass/fail limit for the diode voltage measurement.

To set limit:

- a. Use **(F1)** and **(F2)** to select the digit to edit.
 - b. Use  to change the value.
 - c. Push **(F4)** (Back) to return to the SPD test mode.
4. Connect the test leads from the PV Analyzer to the PV Array.

Tip: Push **INFO** to see a connection diagram.

- a. Connect the blue test lead to one side of the surge protection device.
 - b. Connect green test lead to the other side of the surge protection device.
5. Push **TEST** > 1 s. to start the measurement.

Note

While the test results load,  shows on the display until the test results settle.

When the measurement is complete, the display shows the measured voltage.

6. Push **SAVE** to save the results to memory.

A confirmation message with ID number shows on the display and then returns to the test screen.

Auto Test Sequence

The PV Analyzer has an Auto Test mode that automatically does a test sequence based on these different combinations:

- With Insulation Test compared to Without Insulation Test
- Category 1 compared to Category 1 + 2
- Protection Class I compared to Protection Class II

To set:

1. Turn the rotary switch on the PV Analyzer to **AUTO**.

The display shows the default Auto test mode.

2. Use the  to scroll through the available blank-states of AUTO tests.

The display updates to show the details of the AUTO test.

3. Push  to change AUTO test setup.

 indicates that the PV model is not selected or the Irradiance Meter is not connected.

If not connected after you push :

- a. Change the Test Type.
- b. Enter PV model information.
- c. Pair with Irradiance Meter. See [Pair PV Analyzer to the Irradiance Meter](#).
- d. Use  to scroll until you see the **Set V_N** option.
- e. Select V_N (only available for AUTO tests that include the R_{INS} measurement).
- f. Select R_{LO} limit.
- g. Follow the on-screen prompts to zero the test leads.

Tip: The display shows a connection diagram for how to setup the PV Analyzer to the PV Array system based on the AUTO test selection.



 indicates that the PV model is selected and the Irradiance Meter is connected.

4. Push  to start the AUTO test.

The display shows the sequence of tests. When the sequence is complete, the display shows the **Auto Test Complete** message.

5. Use the  to scroll through the tests.

The display shows **Auto Test Complete** message and shows the results.

6. Use  to scroll through the results.
7. Push  to clear the test results and not save.
8. Push  to save the results to memory.



A confirmation message with ID number shows on the display and then returns to the test screen.

Menu

The Menu function has the options for:

- Memory
- Device Settings
- Help

To open the Menu function:

1. Turn the rotary dial to **MENU**.
2. Use  to highlight a menu item.
3. Push  to select the menu item.

Follow the instructions on the display.

Download Test Results

You can download test measurements from the PV Analyzer to a PC for data management through the IR port.

To download test measurements with the IR port:

1. Turn off the PV Analyzer.
2. Connect the IR serial cable to the serial port on the PC and the IR port on the PV Analyzer. See [Figure 2](#).

Figure 2. IR Serial Cable Attachment

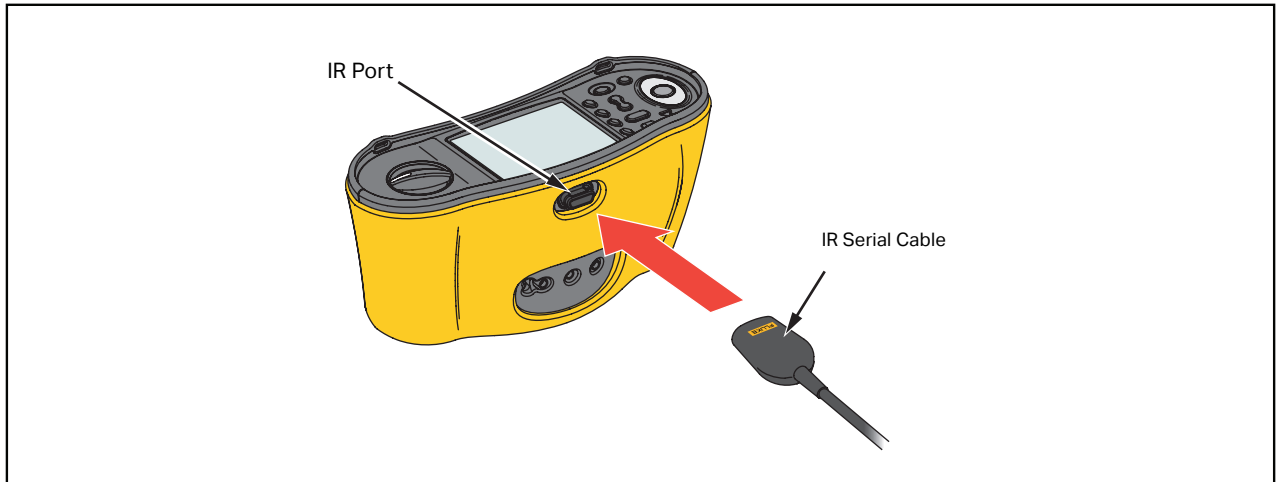

3. At the PC, open the TruTest software program.
4. Turn on the PV Analyzer.
5. See the *TruTest™ Data Management Software* documentation for complete instructions on how to set the date/time stamp and upload data from the PV Analyzer.

Download PV Model Data

See the *TruTest™ Data Management Software* documentation for complete instructions on how to download the PV Model data.

Maintenance

⚠️⚠️ Warnings

To prevent possible electrical shock, fire, or personal injury:

- Be sure that the battery polarity is correct to prevent battery leakage.
- Repair the Product before use if the battery leaks.
- Have an approved technician repair the Product.
- Use only specified replacement parts.
- Replace a blown fuse with exact replacement only for continued protection against arc flash.
- Do not operate the Product with covers removed or the case open. Hazardous voltage exposure is possible.
- Remove the input signals before you clean the Product.

Periodically wipe the case with a damp cloth and mild detergent. Do not use abrasives or solvents. Dirt or moisture in the terminals can affect readings.

To clean the terminals:

1. Turn off the PV Analyzer and remove all test leads.
2. Shake out any dirt that may be in the terminals.
3. Moisten a clean cotton swab with alcohol and clean the inside of each terminal.

Table 8 is a list of replaceable parts for the Tester.

Table 8. Replacement Parts

Description	Part Number
 Fuse, FF 630 mA 1000 V IR 30 kA for PV Analyzer	5335526
Battery Holder	1676850
Battery Access Door	5330087

Fuse Replacement

To replace the fuse (see Figure 3):

1. Push  to turn off the PV Analyzer.
2. Remove the test leads from the terminals.
3. To remove the battery door, use a standard-blade screwdriver to turn the battery door screws (x3) one-quarter turn counterclockwise.
4. Replace the fuse.
5. Replace the battery door.
6. Turn the battery door screws one-quarter turn clockwise to fasten the door.
7. The battery voltage shows in the secondary display.

Warning

To prevent possible electric shock or personal injury due to false readings:

- **Replace the batteries as soon as the  empty battery icon appears.**
- **Be sure that the battery polarity is correct. A reversed battery can cause leakage.**

Battery Replacement

Replace the batteries with six AA batteries. Alkaline batteries are supplied with the Tester.

⚠️⚠️ Warning

To prevent possible electrical shock, fire, or personal injury:

- Remove the test leads and any input signals before you replace the battery.
- Install **ONLY** specified replacement fuses with the amperage, voltage, and interrupt ratings shown in the *Specifications* section of this manual.

To replace the batteries (see [Figure 3](#)):

1. Push  to turn off the PV Analyzer.
2. Remove the test leads from the terminals.
3. To remove the battery door, use a standard-blade screwdriver to turn the battery door screws (x3) one-quarter turn counterclockwise.
4. Push the release latch and slide the battery holder out of the Tester.
5. Replace the batteries.
6. Replace the battery holder and the battery door.
7. Turn the battery door screws one-quarter turn clockwise to fasten the door.

Figure 3. Battery Replacement



Product Disposal

Dispose of the Product in a professional and environmentally appropriate manner:

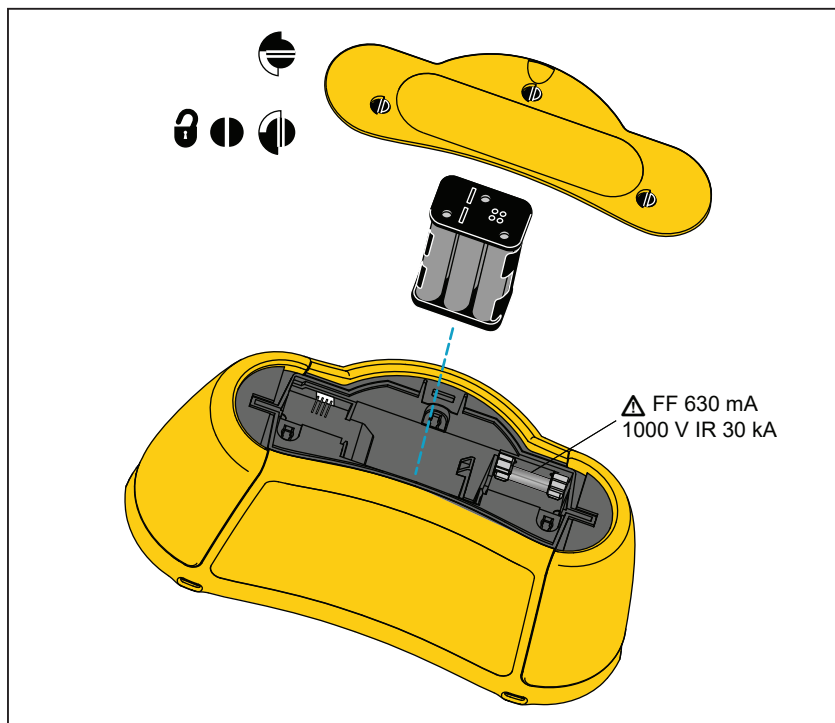
- Delete personal data on the Product before disposal.
- Remove batteries that are not integrated into the electrical system before disposal and dispose of batteries separately.
- If this Product has an integral battery, put the entire Product in the electrical waste.