

QRG**FLUKE****True
RMS**

T6-1000 PRO

Electrical Tester

with FieldSense Technology

Consultare le *Informazioni sulla sicurezza*

Accedere al sito www.fluke.com per registrare il prodotto e per avere maggiori informazioni; altrimenti è possibile scaricare la Guida di riferimento rapido in altre lingue. È possibile consultare la versione cartacea generica delle Informazioni sulla sicurezza fornita con il Prodotto. Dove possibile sono presenti informazioni di sicurezza più specifiche. Le specifiche complete sono disponibili all'indirizzo www.fluke.com.

17,8 mm (0,7")

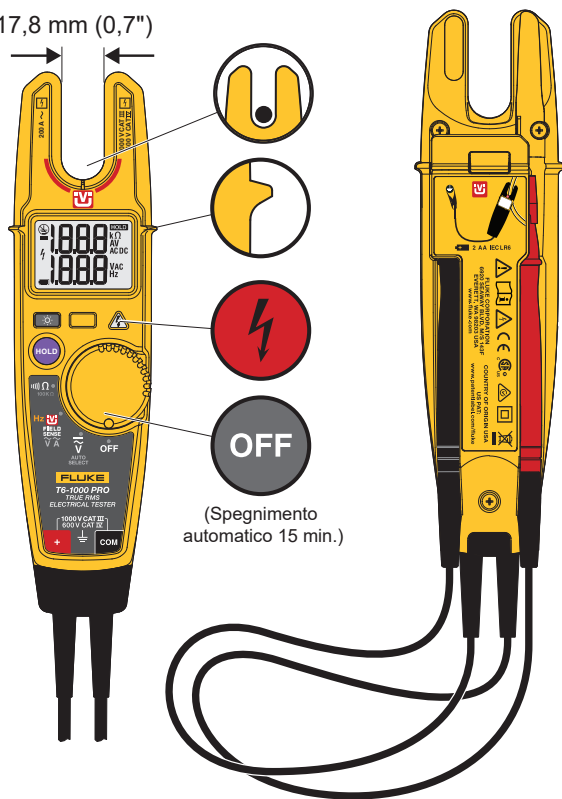
**Simboli**

	Tensione pericolosa 30 V.
	Test con forcina e sonda a massa o pinzetta a coccodrillo.
	Batteria pienamente carica.
	Batteria scarica. Sostituire.
	Retroilluminazione.
	Test con sonde.
	Collegamento di terra assente.

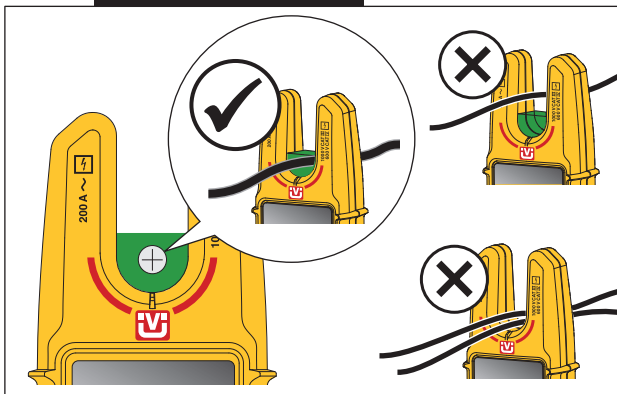
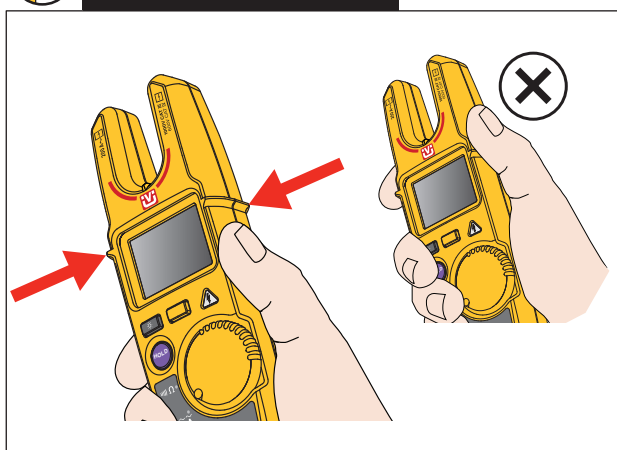
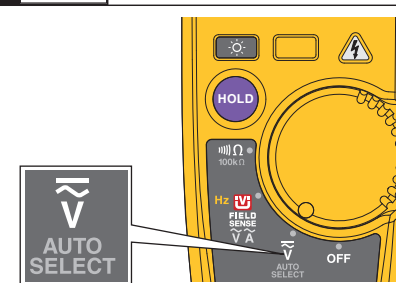
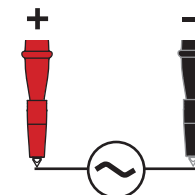
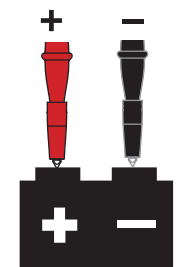
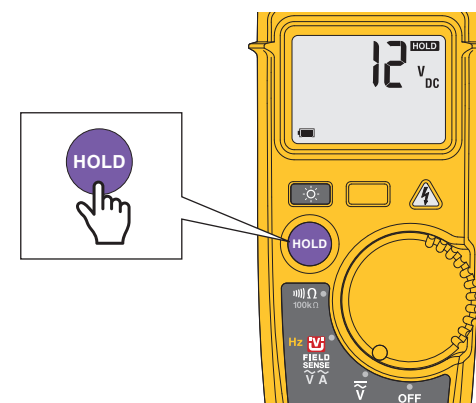
**Posizione del cavo****Protezione per le dita****1****2A** \tilde{V} (AC)**2B** \bar{V} (DC)**HOLD**

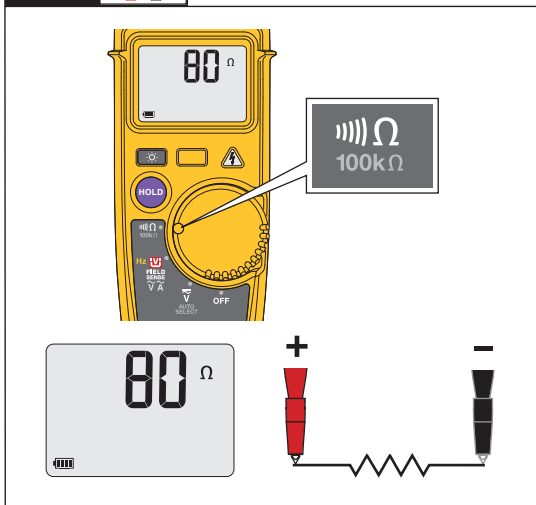
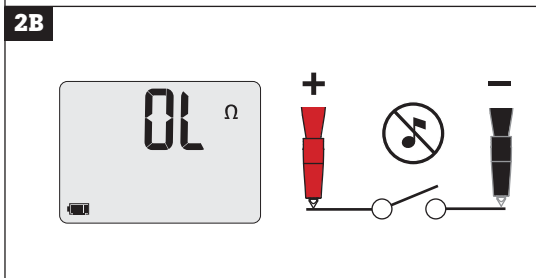
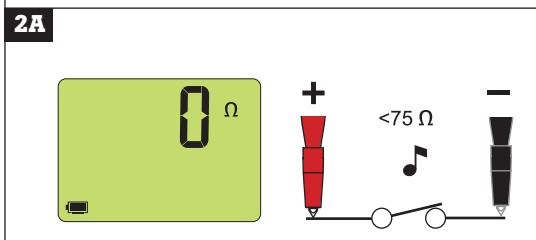
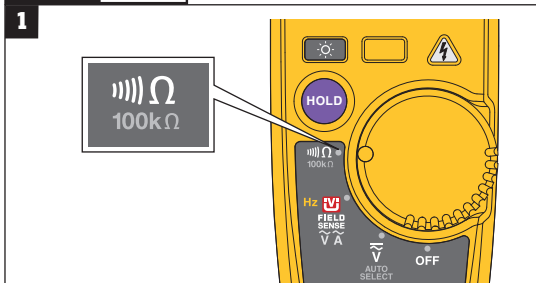
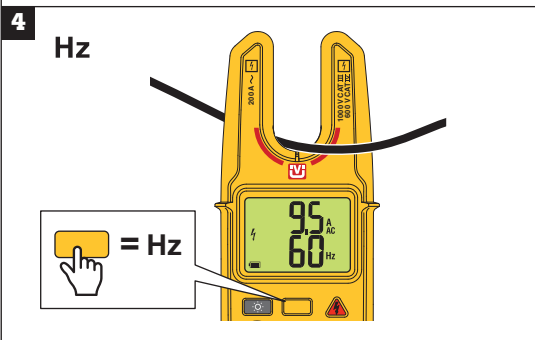
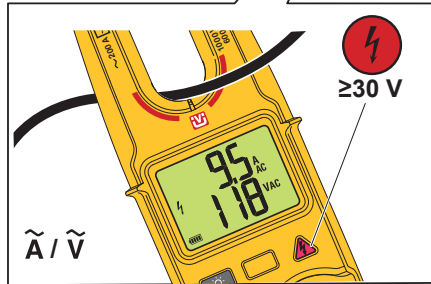
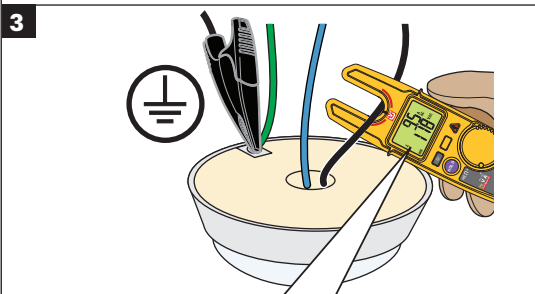
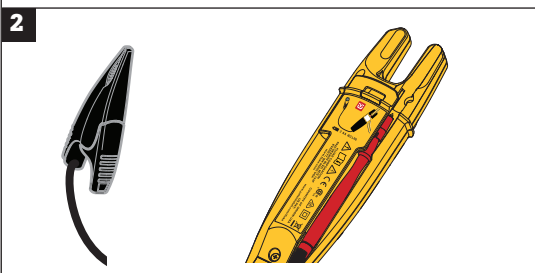
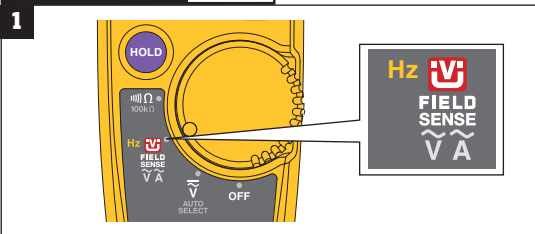

Sostituzione del puntale

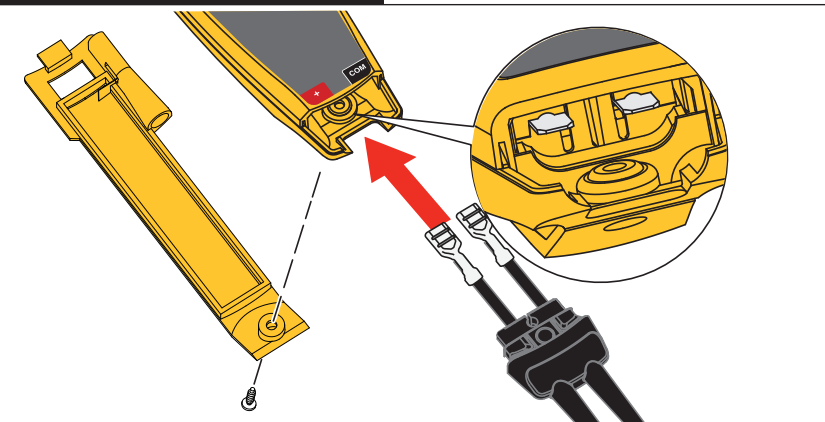

Parti di ricambio

Gruppo puntali (T5-RLS) Sostituire esclusivamente con puntali Fluke con isolamento doppio.	PN 4462973
TP1 sonda singola, punta piatta, rossa	PN 648128
TP1 sonda singola, punta piatta, nera	PN 648102
TP38 sonda singola, punta tonda, rossa	PN 1276841
TP38 sonda singola, punta tonda, nera	PN 1276852
Sportellino della batteria	PN 5132103
Vite dello sportellino della batteria	PN 1618578
Pinzetta a coccodrillo AC285	PN 1610159
Guscio protettivo da cintura H-T6	

