

Programmable AC Power Source

APS-7000 Series

USER MANUAL



ISO-9001 CERTIFIED MANUFACTURER

GW INSTEK

This manual contains proprietary information, which is protected by copyright. All rights are reserved. No part of this manual may be photocopied, reproduced or translated to another language without prior written consent of Good Will company.

The information in this manual was correct at the time of printing. However, Good Will continues to improve products and reserves the rights to change specification, equipment, and maintenance procedures at any time without notice.

Good Will Instrument Co., Ltd.
No. 7-1, Jhongsing Rd., Tucheng Dist., New Taipei City 236, Taiwan.

Table of Contents

SAFETY INSTRUCTIONS	4
GETTING STARTED	8
APS-7000 Series Overview	9
Appearance	14
OPERATION	26
Set Up	28
Basic Operation	60
Advanced Settings	82
Miscellaneous	88
Trigger	95
Preset Settings	100
Arbitrary Waveform Function	104
Test Mode Function	111
REAR PANEL SIGNAL OUTPUTS	147
COMMUNICATION INTERFACE	151
Interface Configuration	152
FAQ	173
APPENDIX	175
Firmware Update	175
APS-7000 Default Settings	177
APS-7000 Specifications	179
APS-7000 Dimensions	186
Certificate Of Compliance (Only for APS-7050 and APS-7100)	190
INDEX	191

S SAFETY INSTRUCTIONS

This chapter contains important safety instructions that you must follow during operation and storage. Read the following before any operation to ensure your safety and to keep the instrument in the best possible condition.

Safety Symbols

These safety symbols may appear in this manual or on the instrument.



WARNING

Warning: Identifies conditions or practices that could result in injury or loss of life.



CAUTION

Caution: Identifies conditions or practices that could result in damage to the APS-7000 or to other properties.



DANGER High Voltage



Attention Refer to the Manual



Protective Conductor Terminal



Earth (ground) Terminal



Do not dispose electronic equipment as unsorted municipal waste. Please use a separate collection facility or contact the supplier from which this instrument was purchased.

Safety Guidelines

General Guideline



CAUTION

- Do not place any heavy object on the APS-7000.
- Avoid severe impact or rough handling that leads to damaging the APS-7000.
- Do not discharge static electricity to the APS-7000.
- Use only mating connectors, not bare wires, for the terminals.
- Do not block the cooling fan opening.
- Do not disassemble the APS-7000 unless you are qualified.

(Measurement categories) EN 61010-1:2010 specifies the measurement categories and their requirements as follows. The APS-7000 doesn't fall under category II, III or IV.

- Measurement category IV is for measurement performed at the source of low-voltage installation.
- Measurement category III is for measurement performed in the building installation.
- Measurement category II is for measurement performed on the circuits directly connected to the low voltage installation.
- 0 is for measurements performed on circuits not directly connected to Mains.

Power Supply



WARNING

- AC Input voltage range:
115/230 Vac \pm 15% (APS-7050, APS-7100)
230 Vac \pm 15% (APS-7200, APS-7300)
 - Frequency: 50/60Hz
 - To avoid electrical shock connect the protective grounding conductor of the AC power cord to an earth ground.
-

- Cleaning the APS-7000
- Disconnect the power cord before cleaning.
 - Use a soft cloth dampened in a solution of mild detergent and water. Do not spray any liquid.
 - Do not use chemicals containing harsh material such as benzene, toluene, xylene, and acetone.

- Operation Environment
- Location: Indoor, no direct sunlight, dust free, almost non-conductive pollution (Note below)
 - Relative Humidity: 20%~ 80%, no condensation
 - Altitude: < 2000m
 - Temperature: 0°C to 40°C

(Pollution Degree) EN 61010-1:2010 specifies the pollution degrees and their requirements as follows. The APS-7000 falls under degree 2.

Pollution refers to “addition of foreign matter, solid, liquid, or gaseous (ionized gases), that may produce a reduction of dielectric strength or surface resistivity”.

- Pollution degree 1: No pollution or only dry, non-conductive pollution occurs. The pollution has no influence.
- Pollution degree 2: Normally only non-conductive pollution occurs. Occasionally, however, a temporary conductivity caused by condensation must be expected.
- Pollution degree 3: Conductive pollution occurs, or dry, non-conductive pollution occurs which becomes conductive due to condensation which is expected. In such conditions, equipment is normally protected against exposure to direct sunlight, precipitation, and full wind pressure, but neither temperature nor humidity is controlled.

- Storage environment
- Location: Indoor
 - Temperature: -10°C to 70°C
 - Relative Humidity: ≤80%, no condensation

Disposal



Do not dispose this instrument as unsorted municipal waste. Please use a separate collection facility or contact the supplier from which this instrument was purchased. Please make sure discarded electrical waste is properly recycled to reduce environmental impact.

Power cord for the United Kingdom

When using the instrument in the United Kingdom, make sure the power cord meets the following safety instructions.

NOTE: This lead/appliance must only be wired by competent persons



WARNING: THIS APPLIANCE MUST BE EARTHED

IMPORTANT: The wires in this lead are coloured in accordance with the following code:

Green/ Yellow:	Earth
Blue:	Neutral
Brown:	Live (Phase)



As the colours of the wires in main leads may not correspond with the coloured marking identified in your plug/appliance, proceed as follows:

The wire which is coloured Green & Yellow must be connected to the Earth terminal marked with either the letter E, the earth symbol  or coloured Green/Green & Yellow.

The wire which is coloured Blue must be connected to the terminal which is marked with the letter N or coloured Blue or Black.

The wire which is coloured Brown must be connected to the terminal marked with the letter L or P or coloured Brown or Red.

If in doubt, consult the instructions provided with the equipment or contact the supplier.

This cable/appliance should be protected by a suitably rated and approved HBC mains fuse: refer to the rating information on the equipment and/or user instructions for details. As a guide, a cable of 0.75mm² should be protected by a 3A or 5A fuse. Larger conductors would normally require 13A types, depending on the connection method used.

Any exposed wiring from a cable, plug or connection that is engaged in a live socket is extremely hazardous. If a cable or plug is deemed hazardous, turn off the mains power and remove the cable, any fuses and fuse assemblies. All hazardous wiring must be immediately destroyed and replaced in accordance to the above standard.

GETTING STARTED

This chapter describes the power source in a nutshell, including its main features and front / rear panel introduction.



APS-7000 Series Overview	9
Series lineup	9
Operating Area	9
Main Features	11
Accessories	12
Appearance.....	14
Front Panel.....	14
Rear Panel.....	19
Status Bar Icons.....	24

APS-7000 Series Overview

Series lineup

The APS-7000 series consists of 4 models, the APS-7050, APS-7100, APS-7200 and APS-7300, differing only in capacity. Note that throughout the user manual, the term “APS-7000” refers to any of the models, unless stated otherwise.

Model name	Max. Output Current	Power Rating	Output Voltage
APS-7050	4.2A/2.1A	500VA	0~310.0 Vrms
APS-7100	8.4A/4.2A	1000VA	0~310.0 Vrms
APS-7200	16.8A/8.4A	2000VA	0~310.0 Vrms
APS-7300	25.2A/12.6A	3000VA	0~310.0 Vrms

Operating Area

APS-7050 Output Operating Area

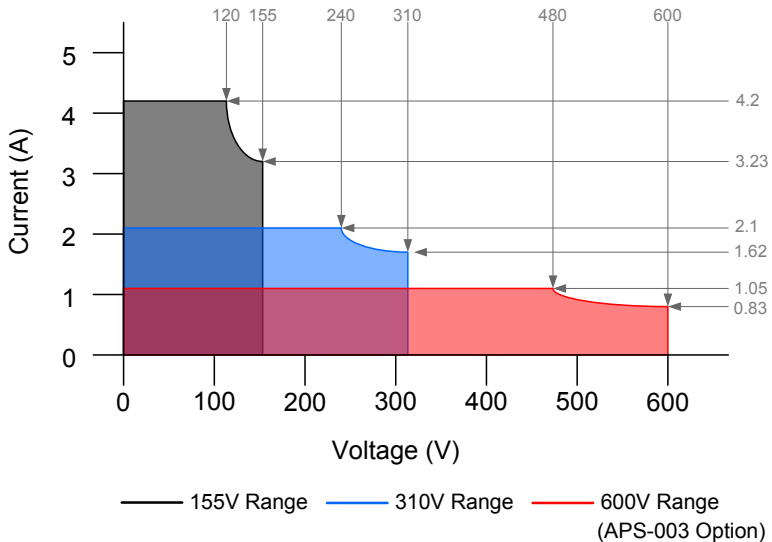

APS-7100 Output Operating Area

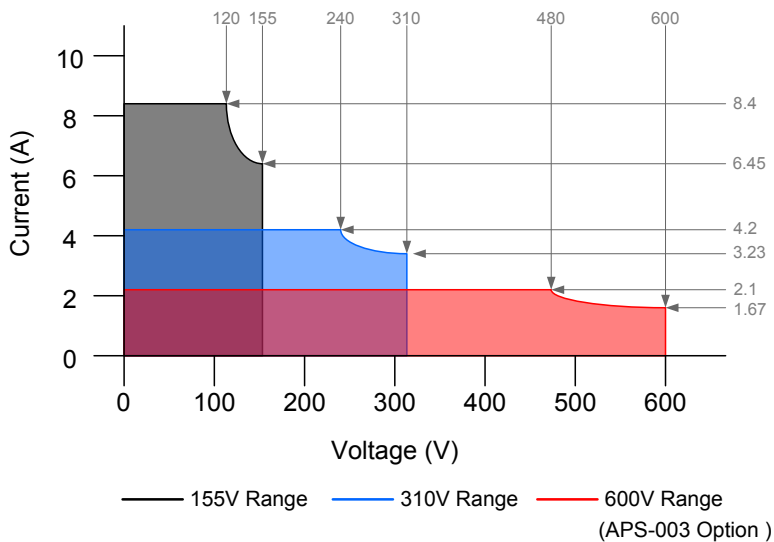

APS-7200 Output Operating Area

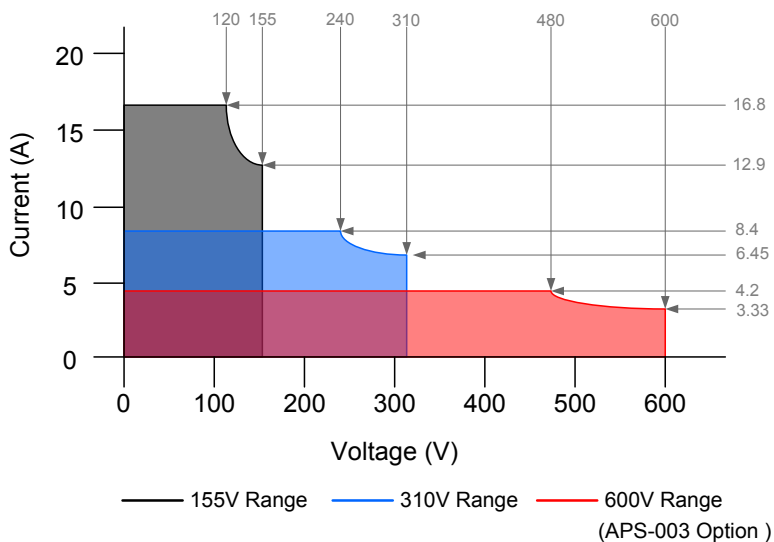

APS-7300 Output Operating Area

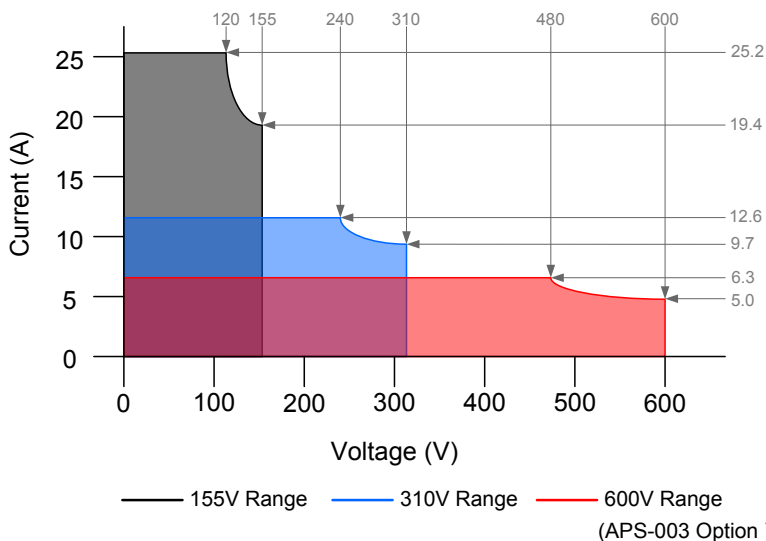

Main Features

- Performance
- Low output ripple and noise
 - Excellent and feature-rich measurement capacity
 - Standard maximum output voltage is 310Vrms
 - Maximum output voltage and frequency of 600Vrms(APS-003 Option)/1000Hz(APS-004 Option)

- Features
- OCP, OPP and OTP protection
 - Variable voltage, frequency and current limiter
 - Sequence and simulation function
 - Large 4.3 inch TFT panel
 - Globally adjustable power inlet not restricted by the power supply environment
 - USB interface is equipped as standard with the ability to save and recall setup files.
 - Only 88mm (2U) case height (APS-7050 and APS-7100 models only).

- Interface
- Standard:
- Ethernet port
 - USB host
 - USB CDC (APS-7200 and APS-7300 models only)
- Optional:
- GPIB
 - RS-232 / USB CDC (APS-7050 and APS-7100 models only)
 - RS-232 (APS-7200 and APS-7300 models only)

Accessories

Standard Accessories	Part number	Description
	CD ROM	User manual, programming manual
	82GW1SAFE0M*1	Safety guide
	Region dependent	Type I Power cord (APS-7050)
	Region dependent	Type II Power cord (APS-7100)

	Region dependent	Type III Power cord (APS-7200, APS-7300)
	62PS-7K0SC701 x1 5302-01613001 x1	Mains terminal cover set (APS-7050)
	62PS-7K0SC401 x1 5302-01613001 x2	Mains terminal cover set (APS-7100)
	GTL-123	Test leads: 1x red, 1x black

Optional Capacity	Part number	Description
	APS-003	Output Voltage Capacity: 0 ~ 600Vrms
	APS-004	Output Frequency Capacity: 45 ~ 1000Hz

Optional Accessories	Part number	Description
	GRA-423	APS-7050 and APS-7100 rack mount kit
	GRA-429	APS-7200 rack mount kit
	GRA-430	APS-7300 rack mount kit
	APS-001	GPIB interface card
	APS-002	RS-232 / USB CDC interface card (APS-7050 and APS-7100 only)
	APS-007	RS-232 interface card (APS-7200 and APS-7300 only)
	APS-008	Air inlet filter(APS-7200 and APS-7300 only)
	GPW-004	Power Cord 8mm ² /3C, 3m Max Length, 105°C, RNYBS8-6*3P, RNYB8-8*3P

Download	Name	Description
	gw_aps.inf	USB driver

Appearance

Front Panel



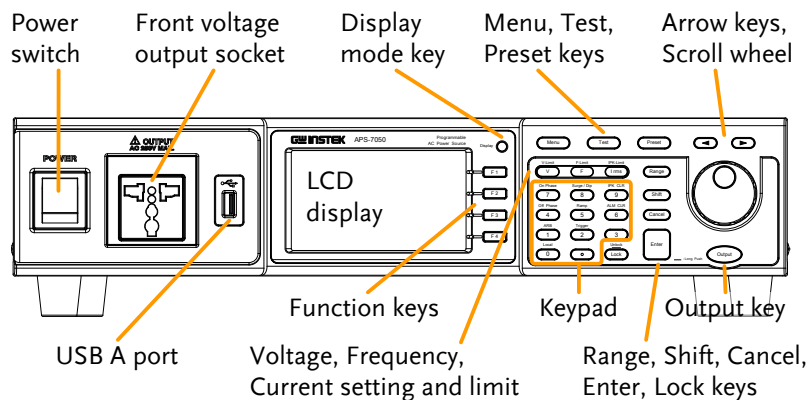

APS-7050, APS-7100



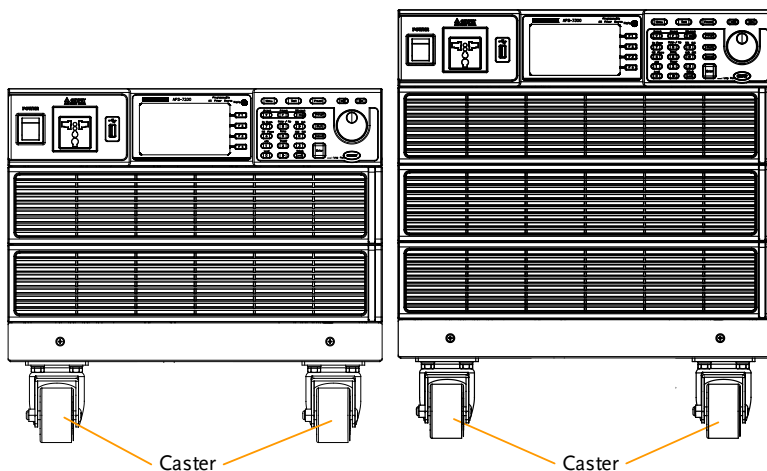

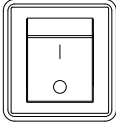
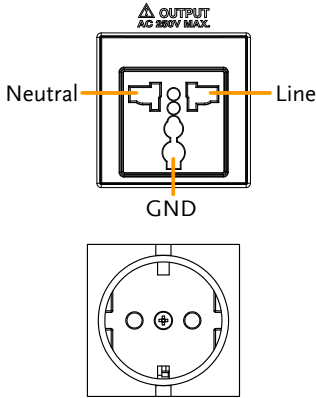

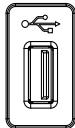





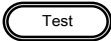
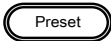

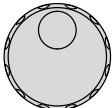

APS-7200

APS-7300



Item	Description	
Power Switch	POWER	Turns on the mains power.
		
Front Voltage Output Socket		Output voltage terminal using a regional universal plug. There is a Euro and a Universal regional plug.
	 CAUTION	Maximum allowable output voltage and current are 250Vrms and 15Arms.
		For voltages exceeding 250Vrms or current over 15Arms, please use the rear output terminal.
		Universal and EURO region plugs socket must be factory installed.
USB A Port		The USB port is used for data transfers and upgrading software.
LCD Screen		Displays the measured values or menu system.
Display Mode Select Key	Display 	Selects between Standard mode and Simple mode.

Function Keys		Assigned to the functions displayed on the right-hand side of the screen.
Menu Key		Enters the Main menu or goes back to one of the display modes.
Test Key		Puts the instrument into the Sequence, Simulation and Program Control mode.
Preset Key		Puts the instrument into Preset mode.
Arrow Keys	 	The arrow keys are used to select the digit power of a value that is being edited.
V		Used for setting the output voltage.
V-Limit	(Shift + V)	Used for setting the output voltage limit value.
F		Used for setting the output frequency.
F-Limit	(Shift + F)	Used for setting the output frequency limit value.
I rms		Used for setting the maximum output current.
IPK-Limit	(Shift + I rms)	Used to set the peak output current limit value.
Range Key		Switches between the 155V, 310V and 600V ranges (the 600V range is an option).
Scroll Wheel		Used to navigate menu items or for incrementing/decrementing values one step at a time.

Lock Key		Locks the number pad to prevent accidentally changing panel settings.
Unlock Key	(Long press)	Disables the key lock.
Enter Key		Confirms selections / settings
Cancel Key		Clears entries that are made in the number entry dialog when a value is edited using the arrow keys or the scroll wheel. The Cancel key can also be used to cancel function setting menus or dialogs.
Shift Key		Turns on the shift state, which enables shortcut operations.
Output Key		Turns the output on or off.
Number Pad		Used to enter values.
Local Mode	(Shift + 0)	Switches operation back to local mode from remote mode.
ARB Mode	(Shift + 1)	Sets the ARB function.
Trigger Mode	(Shift + 2)	Sets the JI port trigger behavior on the rear panel.
Off Phase	(Shift + 4)	Sets the off phase for the output voltage.
RAMP	(Shift + 5)	Quick settings for Ramp control.
ALM CLR	(Shift + 6)	Clears alarms.
On Phase	(Shift + 7)	Sets the on phase for the output voltage.

Surge/Dip	(Shift + 8)	Quick settings for Surge/Dip control.
IPK CLR	(Shift + 9)	Clears peak current hold.

Rear Panel

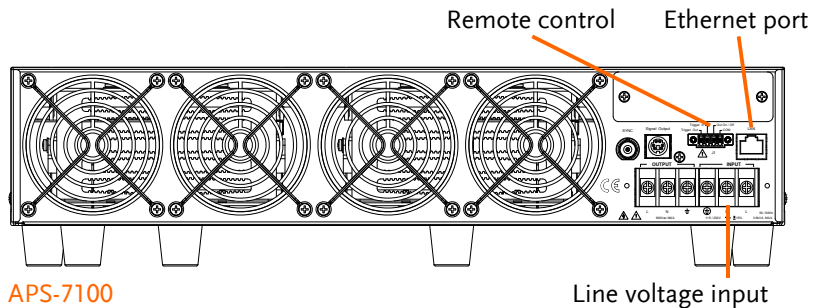
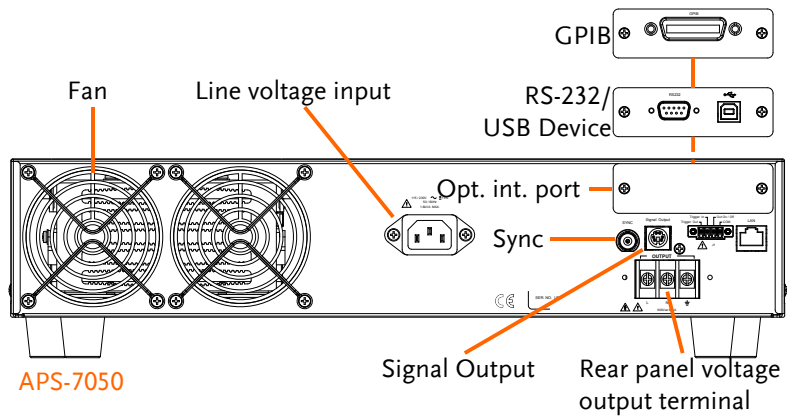

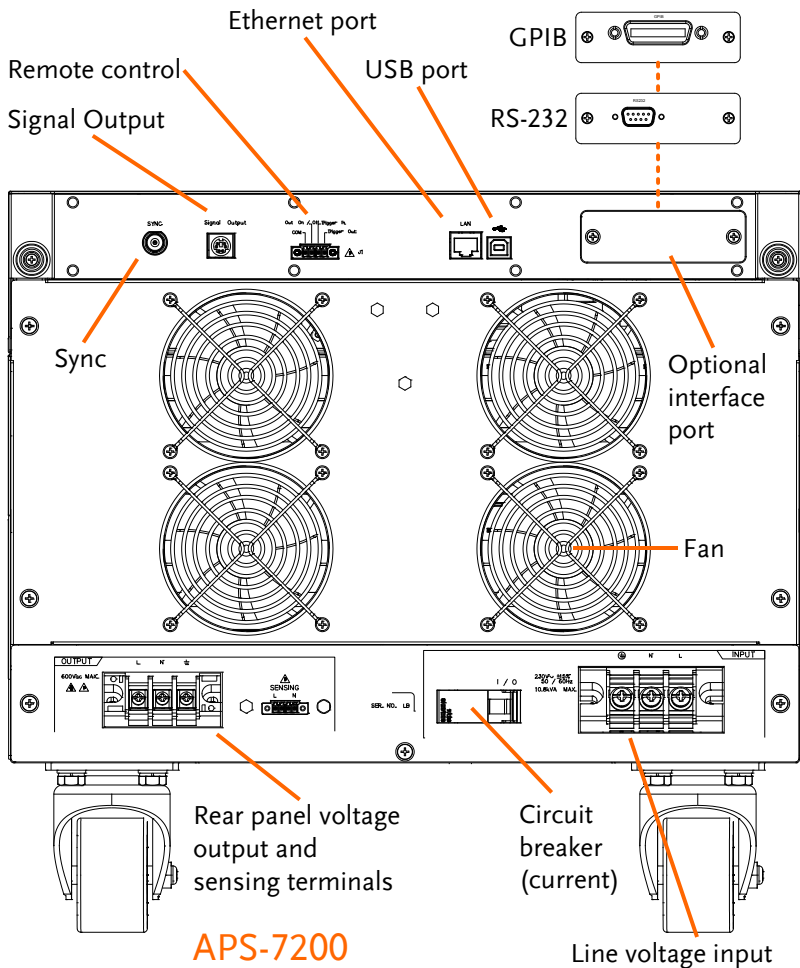

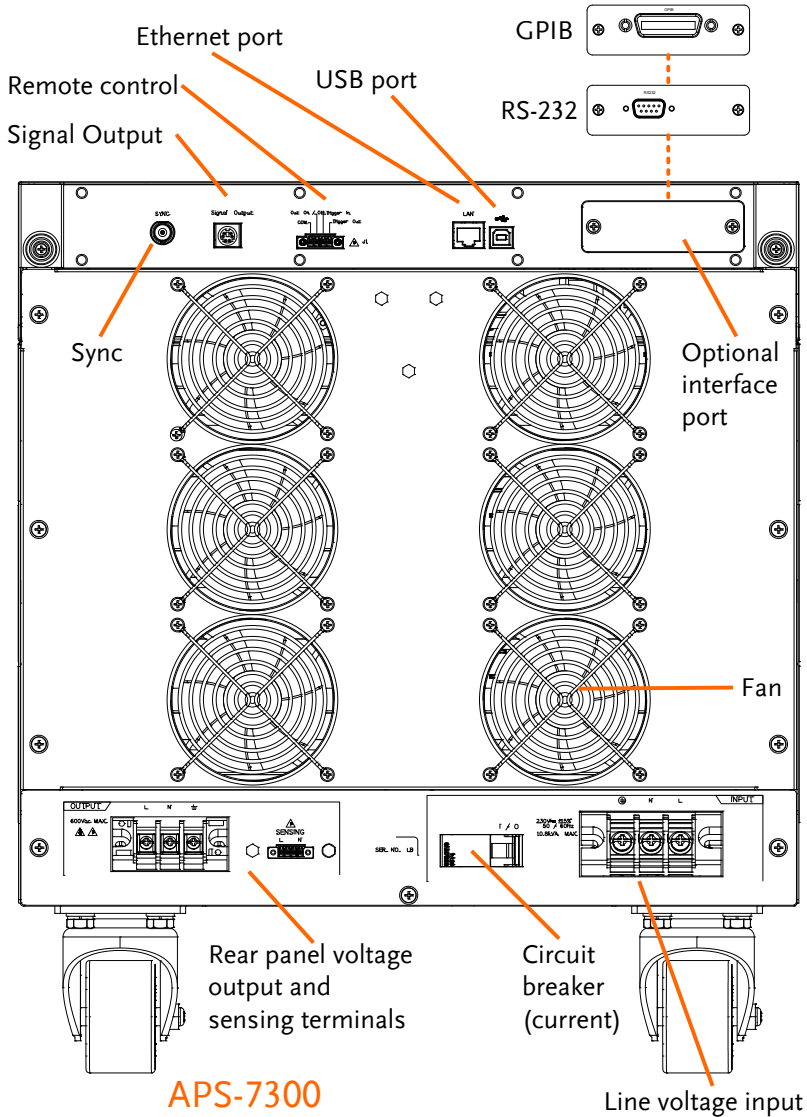

Line Voltage Input

APS-7050

Voltage Input: 115/230±15% VAC;
Line frequency: 50Hz/60 Hz
(Automatically switchable)

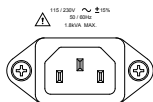

APS-7100

Voltage Input: 115/230±15% VAC ; Line frequency: 50Hz/60 Hz (Automatically switchable)

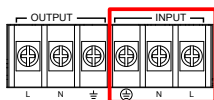

APS-7200 & 7300

Voltage Input: 230±15% VAC ; Line frequency: 50Hz/60 Hz

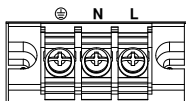

Rear Voltage Output Socket

Output voltage terminal.

APS-7050

APS-7100

APS-7200 & 7300

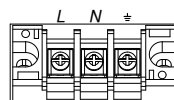
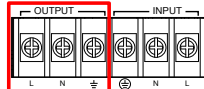
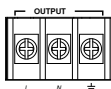

Sync Output Socket



BNC socket. This socket will output a signal of approximately 10V when the output is on.

Signal Output

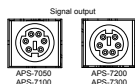

Connector for monitoring PASS, FAIL and PROCESSING output signals when using the Program mode.

Remote Control

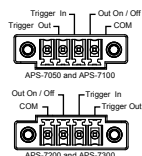

Connector for controlling the TRIGGER IN, TRIGGER OUT and OUT ON/OFF states.

Ethernet Port



The Ethernet port is used for remote control and digital monitoring from a PC.

Optional Interface Slot

Optional GPIB communication, RS-232/USB B communication and RS-232 communication.

Circuit breaker (APS-7200, APS-7300 only)



Main power circuit (current) breaker
 Rating : 40A (APS-7200)
 63A (APS-7300)

Note: Check the status of the power breaker before power-on the APS-7200 or APS-7300.

FAN

Temperature controlled fan.

Remote sense (APS-7200, APS-7300 only)

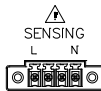

Compensation of the load wire drop.

Status Bar Icons

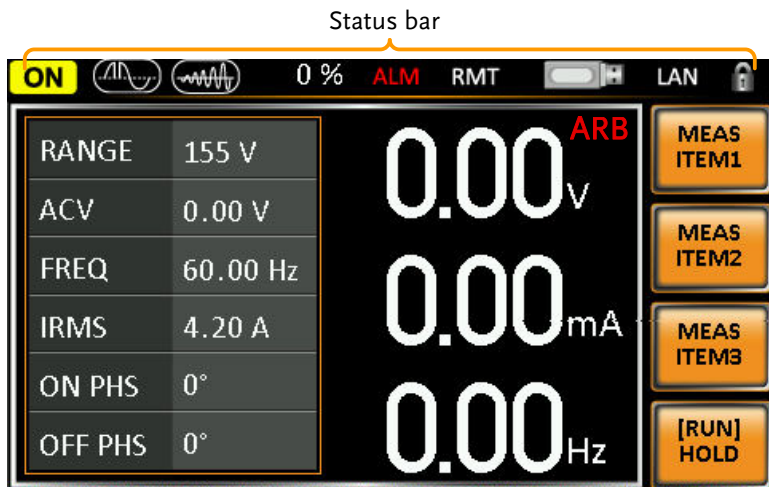

Indicates if the output is ON or OFF.



Indicates the output power as a percentage of full scale.



Indicates that the Surge/Dip function is active.



Indicates that the Ramp function is active.



The alarm icon will appear on the status bar when one of the protection functions are tripped. Applies to Over Power, Over Irms, Over Ipeak and Over Temperature protection.



Indicates that the APS-7000 is in remote mode.



Indicates that a USB drive is detected in the front panel host port.



Indicates that the LAN interface is activated.



Indicates that the panel lock is active.



Indicates that the ARB function is active.

OPERATION

Set Up	28
Line Voltage Removal and Installation for APS-7100	28
Filter Installation	31
Power Up.....	33
Output Terminals.....	34
Wire gauge considerations.....	39
Installing the Optional Hardware Modules.....	41
Installing Optional Software Modules.....	43
Using the Rack Mount Kit	48
How to Use the Instrument.....	50
Reset to Default Settings	54
View System Version and Serial Number.....	55
LCD Configuration.....	56
USB Driver Installation	57
Basic Operation	60
Setting the Voltage Range.....	60
Setting the Voltage Limit	61
Setting the Output Voltage.....	62
Setting the Frequency Limit.....	64
Setting the Output Frequency.....	65
Setting the Peak Current Limit	66
Setting the Current RMS Level.....	70
Setting the On/Off Phase	73
Alarm Clear	74
Display Modes	75
Panel Lock.....	77
Turning the Output On.....	78
Using the remote sense (APS-7200 and APS-7300 only)	79
Local Sense.....	79
Remote Sense	80
Advanced Settings	82
Surge/Dip Control	82
Ramp Control	85
Miscellaneous.....	88

T Ipeak, hold.....	88
Power ON Output.....	90
Buzzer	91
SCPI Emulation	92
Remote Sense (APS-7200 and APS-7300 only).....	93
Trigger	95
Trigger Control Settings	95
Preset Settings	100
Save Preset Settings to Local Memory	100
Load Preset Settings to Local Memory	101
Manage Preset Settings	102
Arbitrary Waveform Function	104
ARB Mode Overview.....	105
Selecting an ARB Waveform	108
Test Mode Function	111
Simulate Mode Overview	112
Simulate Settings	116
Save a Simulation to Local Memory	119
Recall a Simulation from Local Memory	119
Manage Simulation Settings	120
Running a Simulation	122
Sequence Mode Overview.....	124
Sequence Settings	128
Save a Sequence to Local Memory	132
Recall a Sequence from Local Memory.....	132
Manage Sequence Settings.....	133
Running a Sequence	135
Program Mode Overview	137
Save a Program to Local Memory.....	144
Recall a Program from Local Memory.....	144
Manage Program Settings	145

Set Up

Line Voltage Removal and Installation for APS-7100

Background The APS-7100 is equipped with an input power terminal that can accept 115V/230V \pm 15%. To connect or replace the power cord (GW Instek part number 4300-31000101), use the procedure below:



Warning

The following procedure should only be attempted by competent persons.

Ensure the AC power cord is not connected to power.

Removal

1. Turn off the power switch.

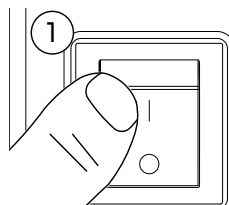

APS-7100

2. Unscrew the power cord protective sheath on the rear output socket.
3. Remove the 2 screws holding the power cord cover and remove.

APS-7100

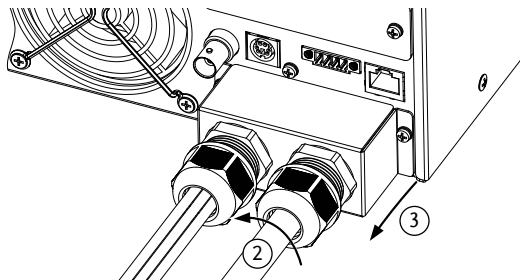

4. Remove the AC power cord wires.

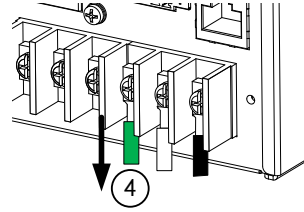

CAUTION

The power line inputs for the APS-7100 are on the outer cluster of terminals.

The terminals to the inner of the panel are the rear panel outputs.

Installation

5. Connect the AC power cord wires to the AC input terminals.

- White/Blue → Neutral (N)
- Green/Green-yellow → GND (⊕)
- Black/Brown → Line (L)

APS-7100

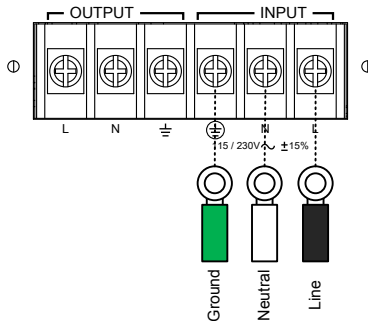

6. Re-install the power cord cover.
7. Screw the power cord sheath back onto the cover.

APS-7100

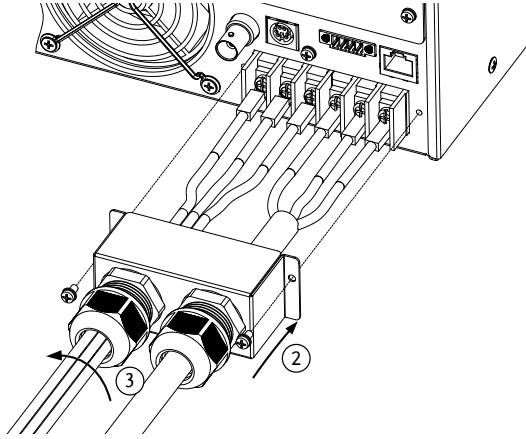

Filter Installation

Background The APS-7200/7300 has a filter (GW Instek part number, 57RG-30B01801) that must first be inserted under the control panel before operation.

Steps

1. Pull outward as indicated in the arrow to detach the snap.

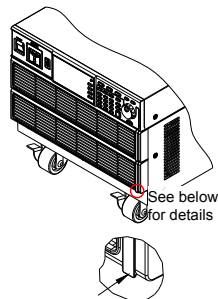

2. Remove the cover

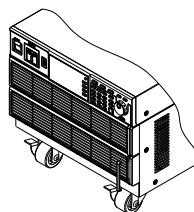

3. Remove the screws

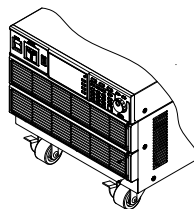

4. Move the plastic frame in the direction indicated by the arrow

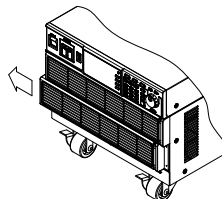

5. Remove the plastic frame.

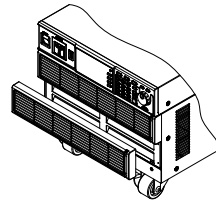

6. Replace the filter with a new one.

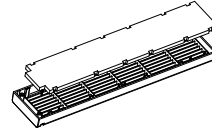

7. The unit is now ready to power up.



Note

Please clean regularly to avoid damaging the internal components of the machine



Warning

The following procedure should only be attempted by competent persons.

Ensure the AC power cord is not connected to power.

Power Up

Steps

1. Socket type (APS-7050):
Connect the power cord to the rear panel socket.

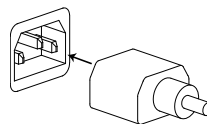

Input Power Terminal (APS-7100, 7200 & 7300):
Connect the power cord to the input power terminals.

APS-7200 & 7300, see page 22,
APS-7100, see page 28.

2. Press the POWER key. The splash screen will appear momentarily before the continuous mode screen appears with the settings loaded.

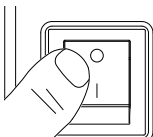

CAUTION

The power supply takes around 10 seconds to fully turn on and shutdown.

Do not turn the power on and off quickly.

Output Terminals

Background The output terminals can be output from either the front panel or from the rear panel. The outputs are limited to 4.2A/2.1A (APS-7050), 8.4A/4.2A (APS-7100), 16.8A/8.4A (APS-7200) or 25.2A/12.6A (APS-7300).

Supported plugs Multi-region terminal Socket
 Supported Standards
 IEC, North America, Japan.
 EURO CEE type universal plug

 **WARNING** Dangerous voltages. Ensure that the power to the instrument is disabled before handling the power supply output terminals. Failing to do so may lead to electric shock.

 **CAUTION** For the front panel output, the maximum output voltage is 250VAC and current is 10A.

- Front Panel Output Connection**
1. The front panel has a multi-region power socket depending on the socket type.
 2. Insert the plug from the DUT into the socket.

(APS-7050 or APS-7100 shown)

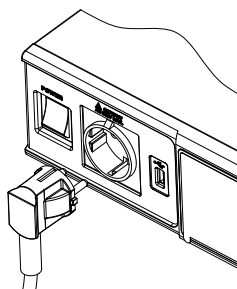

EURO CEE socket

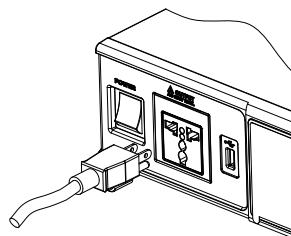

IEC North America, Japan

**WARNING**

Dangerous voltages. Ensure the output is off before unplugging the plug from the front panel socket.

3. Turn the power on. The AC power supply is now ready to power the DUT.

Rear Panel Output Connection The rear panel output is used to supply higher power DUTs. The rear panel output connection is similar to the universal rear panel line input connection on the APS-7100, APS-7200 or APS-7300.

1. Disconnect the unit from the mains power socket and turn the power switch off.
2. Unscrew the power cord protective sheath (APS-7050 and APS-7100).
3. Remove the 2 screws holding the power cord cover and remove (APS-7050 and APS-7100).

APS-7050

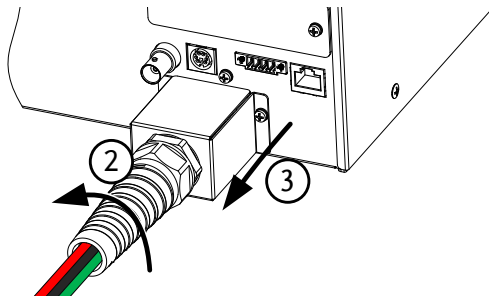

APS-7100

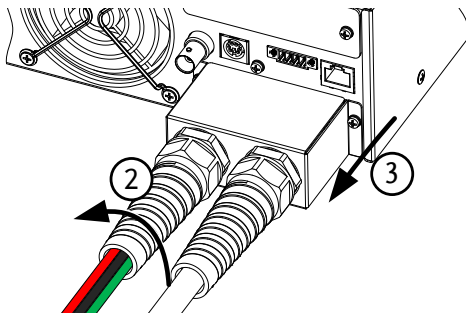

CAUTION

For the APS-7100, there is a single bank for the input and output terminals. Ensure the correct terminals are connected. The APS-7050, APS-7200 and APS-7300 have a dedicated bank of output terminals on the rear panel.

Installation

4. Connect the output AC power cord wires to the AC output terminals.
 - Black → Neutral (N)
 - Green → GND (⊕)
 - Red → Line (L)

APS-7100

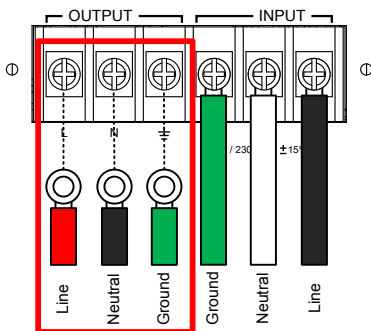

APS-7100 shown. The input terminals are already connected and shows which output terminals are to be connected.

APS-7050, APS-7200 and APS-7300

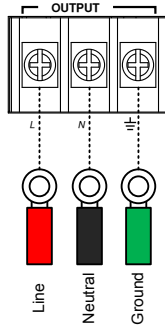

APS-7050 shown.

5. Re-install the power cord cover (APS-7050 and APS-7100).
6. Screw the power cord sheath back onto the cover (APS-7050 and APS-7100).

APS-7050

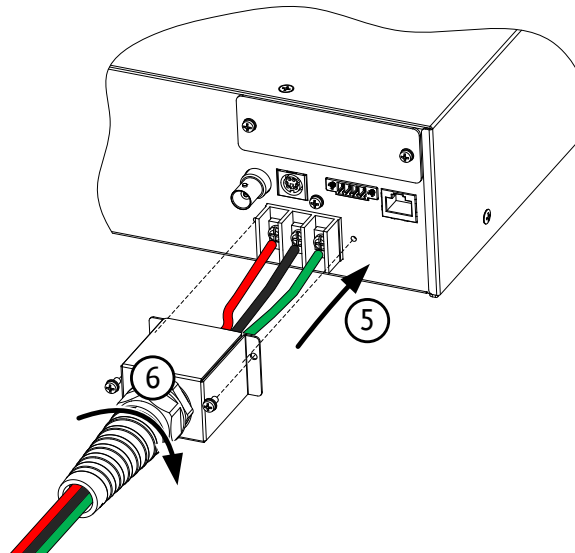

APS-7100

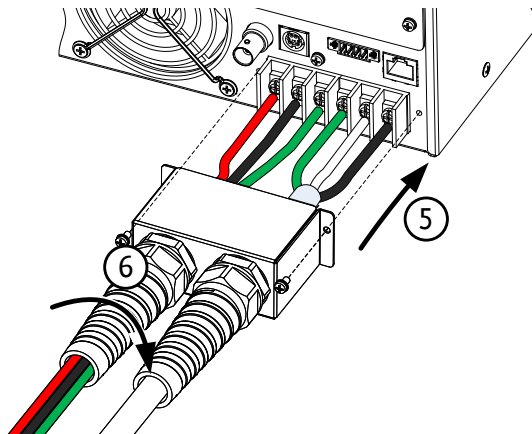

7. Turn the power on. The AC power supply is now ready to power the DUT.



Note

Grounded Neutral Output:

APS-7000 allows for a grounded return on the neutral output.

It is suit for the medical industry that required between ground with neutral is 0V essentially. And possible to mitigate ground loops that is ideal for reduce ground noise and isolate sensitive equipment from the effects of ground loops.



WARNING

Because the neutral has been referenced to the chassis ground, be careful electric shock by yourself.

Wire gauge considerations

Background Before connecting the output terminals to a load, the wire gauge of the cables should be considered.

It is essential that the current capacity of the load cables is adequate. The rating of the cables must equal or exceed the maximum current rated output of the instrument.

Recommended wire gauge	Wire Gauge	Nominal Cross Section	Maximum Current
	20	0.5	9
	18	0.75	11
	18	1	13
	16	1.5	18
	14	2.5	24
	12	4	34
	10	6	45
	8	10	64
	6	16	88
	4	25	120
	2	32	145
	1	50	190
	00	70	240
	000	95	290
	0000	120	340

The maximum temperature rise can only be 60 degrees above the ambient temperature. The ambient temperature must be less than 30 degrees.

To minimize noise pickup or radiation, the load wires and remote sense wires should be twisted-pairs of the shortest possible length. Shielding of the sense leads may be necessary in high noise environments. Where shielding is used, connect the shield to the chassis via the rear panel ground screw. Even if noise is not a concern, the load and

remote sense wires should be twisted-pairs to reduce coupling, which might impact the stability of the power supply. The sense leads should be separated from the power leads.

Installing the Optional Hardware Modules

Background There are a number of optional modules that can be installed for remote control.

Optional Modules

APS-001	GPIB Interface card
APS-002	RS-232/USB CDC interface card
APS-007	RS-232 interface card

**WARNING**

Dangerous voltages. Ensure that the power to the instrument is disabled before handling the power supply output terminals. Failing to do so may lead to electric shock.

**CAUTION**

Ensure the power is off before installing any of the optional modules.

Installation

1. Turn off the power switch.

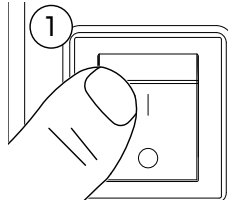

2. Unscrew the two screws holding the options panel plate.

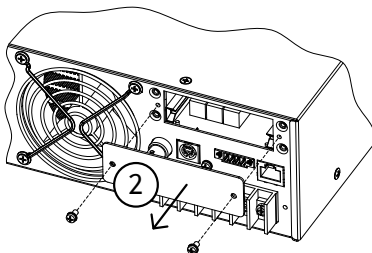

APS-7100 shown

3. Slide the module PCB onto the rails on the inside of the module slot.
4. Secure the module with the screws that were removed from step 2.

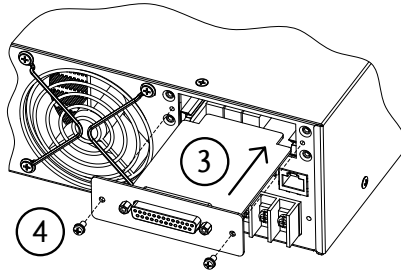

APS-7100 shown

5. The module will be recognized upon startup.

Installing Optional Software Modules

Background The APS-003 and APS-004 are optional software modules that upgrade the voltage limit and frequency limit to 600Vrms and 1000Hz, respectively. Like the firmware, the software modules can be upgraded using the USB A port on the front panel. See your local distributor or GW Instek to purchase these options.



WARNING

The APS-003 and APS-004 software module license keys have been updated and there are now two license key file formats in use:

- The old license keys were tied to the serial number of the APS-7000 unit. The license key files used XXXXXX.lis formatting, where XXXXXX was the serial number of the unit the license key is intended for.
- The new license keys are no longer tied to serial numbers. These new license key files use XXXXXX.lic formatting (APS003.lic & APS004.lic). The new license keys can be exported and transferred to different units.

The old and new license keys are to be used with the following equipments and restrictions:

- Old license key (*.lis): can only be used with the APS-7050 and the APS-7100 with a firmware version below V1.08.
- New license key (*.lic): APS-7050 and APS-7100 with a V1.08 firmware version or above; any APS-7200; any APS-7300.



Note

To upgrade APS-003 or APS-004, it is recommended to upgrade the software version to the latest one. For software, please contact GW or local distributors.

OLD LICENCE KEY INSTALLATION (XXXXXX.LIS format)



Note

This installation guide only applies to APS-7050 and APS-7100 equipments with a firmware version below V1.08.

These options require your serial number. The older license keys are not longer available for purchase.

The serial number on the APS unit must match the XXXXXX.lis filename, or the upgrade will fail.

See page 55 for instructions on how to view your serial number

Steps

1. Insert the USB flash drive into the USB port on front panel of the APS-7000.
 - The USB drive should include the **XXXXXX.lis** file in a directory named "gw" (USB\gw:).
2. Press the *Menu* key. The Menu setting will appear on the display. 
3. Use the scroll wheel to go to item 11, *Special Function* and press *Enter*.
4. Key in the password when prompted and then press *Enter*.
 - The password is "5004".
5. Go to Item 5, *Add New Module* and press *Enter*.

- If the upgrade is successful, “Vlimit Enabled” or “Flimit Enabled” will appear on the screen.

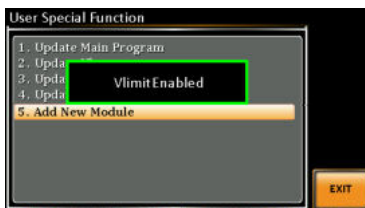

Vlimit option successfully upgraded

- Invalid License
- If the upgrade is not successful, “Invalid License” will be displayed. Check to make sure the serial number and the XXXXXX.lis filename match.

NEW LICENCE KEY INSTALLATION (XXXXXX.LIC format)



Note

This installation guide only applies to firmware versions 1.08 or above on APS-7050, APS-7100, APS-7200 and APS-7300 equipments. Do not attempt this installation procedure with older firmware.

The license keys (APS003.lic & APS004.lic), can be exported and transferred to another APS-7000 power supply of the same model at anytime. A license key can only be used with one machine at a time.

- Steps
- Insert the USB flash drive into the USB port on front panel of the APS-7000.
 - The USB drive should include the **APS003.lic** or **APS004.lic** file in a directory named “gw” (USB\gw:).
 - Press the *Menu* key. The Menu setting will appear on the display.



3. Use the scroll wheel to go to item 11, *Special Function* and press *Enter*.
4. Key in the password when prompted and then press *Enter*.
 - The password is “5004”.
5. Go to Item 5, *Add New Module* and press *Enter*.
6. If the upgrade is successful, “Vlimit Enabled” or “Flimit Enabled” will appear on the screen.
7. Reset the power to the unit when prompted.



- Invalid License
8. If the upgrade is not successful, “Invalid License” will be displayed.

NEW LICENCE KEY EXPORT (XXXXXX.LIC format)



Note

This guide will EXPORT the license key back to the USB flash drive* so that the license key can be installed on a different unit.

*The same USB flash drive that originally contained the *.lic license key must be used when exporting the license key.

- Steps
1. Insert the USB flash drive into the USB port on front panel of the APS-7000.

2. Press the *Menu* key. The Menu setting will appear on the display. 
3. Use the scroll wheel to go to item 11, *Special Function* and press *Enter*.
4. Key in the password when prompted and then press *Enter*.
 - The password is “5004”.
5. Press F1 Export APS-003 or F2 Export APS-004.
6. Reset the power to the unit when prompted.

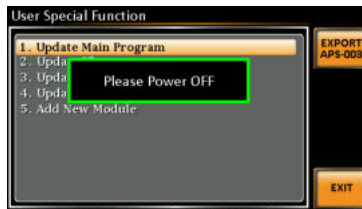

7. The APS003.lic or APS004.lic will now be in the GW directory of the USB flash drive.



You can only export one license key at a time.

You cannot have two license keys on the same USB drive.

You cannot copy a license key to another USB drive. Trying to do so will cause the file to be lost or to be mismatched.

Using the Rack Mount Kit

Background The APS-7050, APS-7100, APS-7200 and APS7300 have optional Rack Mount kits:

Model	Rack Mount kit part number
APS-7050 & 7100	GRA-423
APS-7200	GRA-429
APS-7300	GRA-430

The APS-7050 and APS-7100 are designed to fit into a 2U rack height. The APS-7200 is designed to fit into a 7U rack height. The APS-7300 is designed to fit into a 9U rack height. Please see your distributor for further rack mount details.

Rack mount diagram (APS-7050 or 7100)

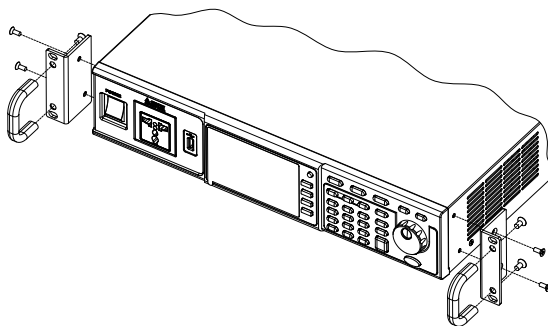

Rack mount
diagram (APS-
7200)

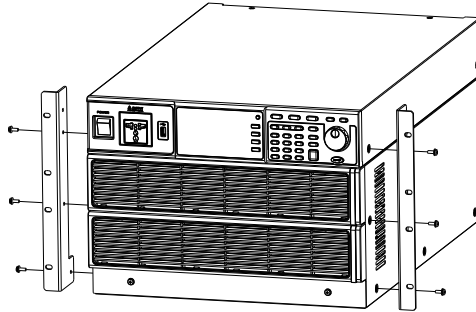

Rack mount
diagram (APS-
7300)

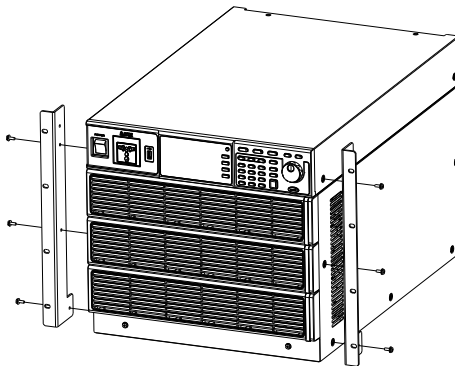

Ensure adequate ventilation is provided when using the rack mount. Ensure at a gap of at least 50mm is given for the side air intakes. Failure to do so may cause the instrument to overheat.

How to Use the Instrument

Background The APS-7000 AC power supplies generally use the scroll wheel, arrow keys and Enter keys to edit numerical values or to select menu options.

Menu navigation is performed using the menu keys and function keys on the front panel.

The following section will explain some of these concepts in detail.

Selecting Menu Items

1. Turn the scroll wheel to select parameters in menus and lists. The selected parameter will be highlighted in orange. The scroll wheel is also used to increment/decrement setting values.
2. Press the Enter key to edit the parameter or to enter the selected menu.

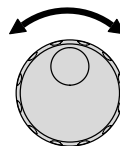

Example

Selected parameter

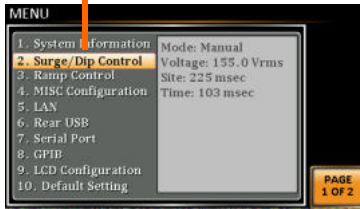

The following is an example of the menu list that appears when the Menu key is pressed.

Using the Keypad to edit parameter values

When editing a value the keypad can be used to directly enter the desired value.

1. Type the value of the parameter using the keypad.

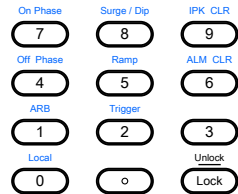

2. Press the Enter key to confirm the edit.



Example

Parameter

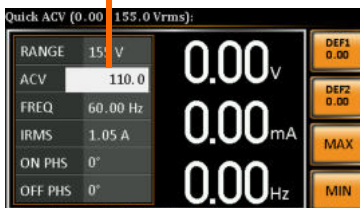

Using the Arrow Keys and Scroll wheel to edit parameter values

Use the arrow keys to select a digit power and then use the scroll wheel to edit the value by that power.

1. Use the arrow keys to move the cursor to the digit of the desired power.



2. Turn the scroll wheel to edit the value by the resolution of the selected digit.

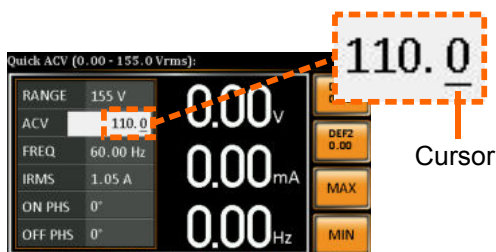
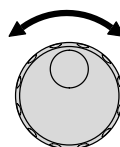

3. Repeat the steps above for all the relevant digits.

4. Press the Enter key to confirm the edit.



Note

By default the cursor starts at the lowest power digit.

Using the onscreen keyboard

The onscreen keyboard is only used in the Program Mode. The screenshot below is an example of the onscreen keyboard.

On screen keyboard



Entered characters

Using the Function Keys

The function keys are quick settings keys, the function of which depends on the current menu or operation.

1. Press the function key that corresponds to the setting directly to its left.
2. The setting or parameter is immediately executed.

Function keys

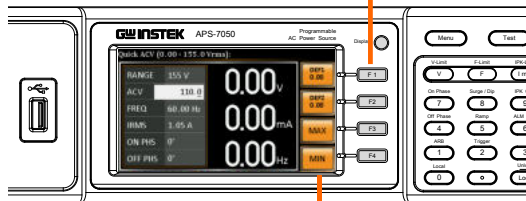

Corresponding quick settings

3. Repeat the steps above for all the relevant digits.

Reset to Default Settings

Background The default settings can be restored from the Menu key settings. See page 177 for the default factory settings.

- Steps**
1. Press the *Menu* key. The Menu settings will appear on the display. 
 2. Use the scroll wheel to go to item 10, *Default Setting*.
 3. Press *Enter* x2 to restore the default settings.

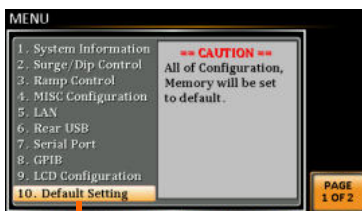

Default settings

View System Version and Serial Number

Background The Menu>System Information setting displays the serial number and version number.

Steps

1. Press the Menu key. The Menu setting will appear on the display. 
2. The system information should now be listed on the display.

If not, use the scroll wheel to go to item 1, *System Information*.

System Information

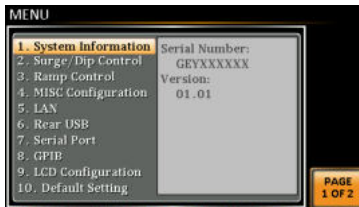

LCD Configuration

Background The LCD Configuration setting sets the brightness, contrast and saturation level of the LCD display.

- Steps**
1. Press the *Menu* key. The Menu settings will appear on the display. 
 2. Use the scroll wheel to go to item 9, *LCD Configuration* and press *Enter*.
 3. Set the brightness, contrast and saturation.
 - Contrast(%) 1 ~ 100% (Default=50%)
 - Brightness(%) 1 ~ 100% (Default=50%)
 - Saturation(%) 1 ~ 100% (Default=50%)

- Exit**
4. Press *Exit*[F4] to exit from the Ramp Control settings. 

- Default Settings**
5. Press *Default*[F3] to set all the LCD settings to 50%.

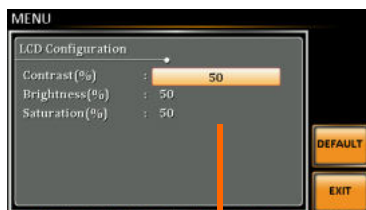

LCD settings

Default settings

USB Driver Installation

Background If the USB Type B interface is to be used for remote control, the USB driver needs to be installed.



Note

The USB driver, *GW_APS.inf*, is located on the CD Rom that accompanied this user manual. Alternatively the driver can be downloaded from the GW Instek website.

For information on the USB interface, see page 152.

- Steps**
1. Connect the rear panel USB -B port on the APS-7000 to the PC using a USB Type A to B cable.
 2. Go the Windows Device Manager.

For Windows 7:
Start > Control Panel > Hardware and Sound > Device Manager

3. The APS-7000 will be located under *Other Devices* in the hardware tree. Right-click the APS-7XXX and choose *Update Driver Software*.

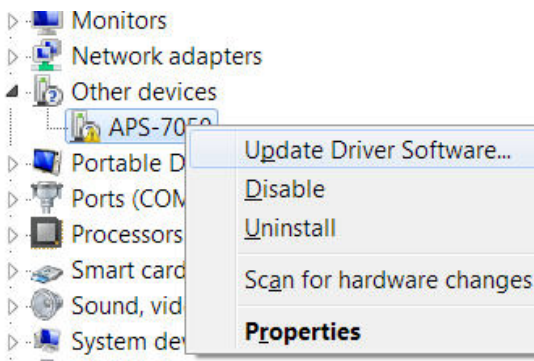

4. From the hardware wizard choose Browse my computer driver software.

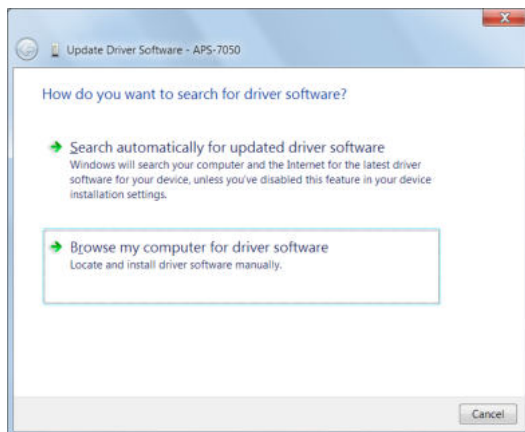

5. Set the file path to the location of the USB driver, click Next and finish the driver installation.

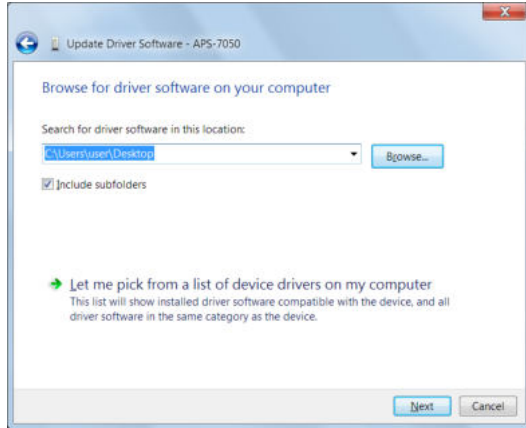

6. In APS-7000 will now be located in the *Ports* node of the hardware tree in the Windows Device Manager if the driver installation was successful.



Basic Operation

This section describes the basic operations required to operate the power supply.

- Setting the Voltage Range → from page 60
- Setting the Voltage Limit → from page 61
- Setting the Output Voltage → from page 62
- Setting the Frequency Limit → page 64
- Setting the Output Frequency → page 65
- Setting the Peak Current Limit → from page 66
- Setting the Current RMS Level → from page 68
- Setting the On/Off Phase → from page 73
- Clearing the Alarm → from page 74
- Setting the Display mode → from page 75
- Panel lock → from page 77
- Turning the Output on/off → from page 78
- Using the remote sense (APS-7200, APS-7300) → from page 79

Before operating the power supply, please see the Getting Started chapter, page 8.

Setting the Voltage Range

Background The Range setting determines the general outlet voltage range. The ranges available correspond to common mains output voltage standards.

Steps 1. Press Range to access the Range menu.

A button with the word "Range" inside, enclosed in a rounded rectangular border.

- Set the voltage range with the scroll wheel or with the F1 ~ F4 soft-keys.

Range	AUTO, 600V(option), 310V, 155V
-------	--------------------------------

Soft-keys	AUTO, 600V(option), 310V, 155V
-----------	--------------------------------

- Press Enter to confirm the Range setting.

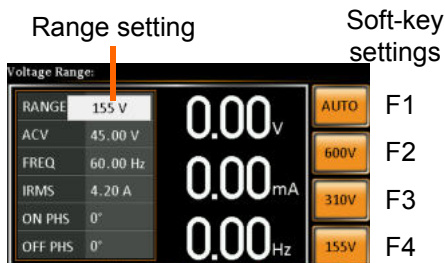

Note

If the range is changed from 155V to 600V, the Irms and IPK values will automatically be changed to a lower value. If the range is changed from 600V to 155V, the Irms and IPK values remain the same.

If the voltage range is changed when the output is on, the output will be automatically turned off.

Setting the Voltage Limit

Background Setting the voltage limit allows the output voltage to be set to any level within the voltage limit (V Limit) range.

Steps 1. Press *Shift* + *V* to access the Volt Limit menu.

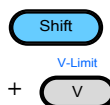

- Set the voltage limit with the scroll wheel or with the F3 ~ F4 soft-keys. The MAX and MIN soft-keys set the limit to the maximum and minimum, respectively.

Range	10% of full range ~ full range
-------	--------------------------------

Soft-keys	MAX, MIN
-----------	----------

- Press *Enter* to confirm the voltage limit setting.

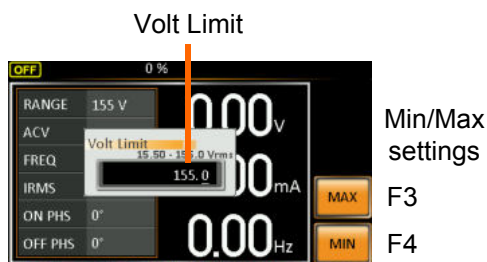

Note

Each voltage range (155V, 310V, 600V) has an independent voltage limit. Before change volt limit setting, if ACV setting value is bigger than desire volt limit value, so that the volt limit value can't be change.

Setting the Output Voltage

The voltage setting sets the voltage level of the power supply.

Background	Before setting the power supply voltage level, set the voltage range and voltage limit.
------------	---

Steps

- Press the V key. The ACV parameter will be editable.
- Set the voltage with the scroll wheel/keypad or with the F1 ~ F4 soft-keys.



Range 0 volts ~ full range

Soft-keys DEF1, DEF2, MAX, MIN

3. Press *Enter* to confirm the voltage setting.

Preset Settings The DEF1 and DEF2 preset settings are user defined settings. By default they are set to 0.00 volts. The MAX and MIN soft-keys set the voltage to the maximum and minimum, respectively.

4. Press the *V* key and set the desired voltage with the scroll wheel/keypad.

Range 0 volts ~ full scale of voltage range

5. Press and hold the DEF1 or DEF2 soft-key until "Saved to DEF1/2" is displayed. This will save the voltage setting to the DEF1 or DEF2 soft-key.



Note

Trying to set the voltage outside of the voltage limit/range will result in a voltage setting error being displayed on the screen.

The voltage level can be set when the output is on.

Example

Voltage setting

Preset voltage settings

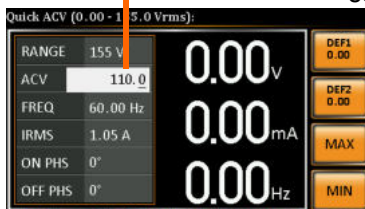

F1

F2

F3

F4

Setting the Frequency Limit

Background Setting the frequency limit allows the frequency output to be set to any level within the limit range.

- Steps**
1. Press *Shift + F* to access the Freq Limit menu.

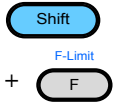
 2. Set the frequency limit with the scroll wheel/keypad or with the F3 ~ F4 soft-keys. The MAX and MIN soft-keys set the frequency limit to the maximum and minimum, respectively.

Range 45.00 ~ 500.0Hz (1000Hz option)

Soft-keys MAX, MIN

3. Press *Enter* to confirm the limit setting.

Example

Freq Limit

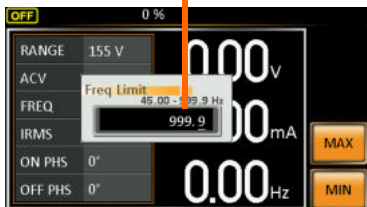

Min/Max settings
F3
F4



Before change freq limit setting, if FREQ setting value is bigger than desire freq limit value, so that the freq limit value can't be change.

Setting the Output Frequency

The frequency setting sets the frequency of the output.

Background	Before setting the frequency, set the frequency limit.
------------	--

- | | | | | | |
|---|--|---|---------------------------------|-----------|----------------------|
| Steps | 1. Press the <i>F</i> key. The FREQ parameter will be editable. |  | | | |
| | 2. Set the frequency with the scroll wheel/keypad or with the F1 ~ F4 soft-keys. | | | | |
| | <table border="1"> <tr> <td>Range</td> <td>45.00 ~ 500.0Hz (1000Hz option)</td> </tr> <tr> <td>Soft-keys</td> <td>DEF1, DEF2, MAX, MIN</td> </tr> </table> | Range | 45.00 ~ 500.0Hz (1000Hz option) | Soft-keys | DEF1, DEF2, MAX, MIN |
| Range | 45.00 ~ 500.0Hz (1000Hz option) | | | | |
| Soft-keys | DEF1, DEF2, MAX, MIN | | | | |
| 3. Press <i>Enter</i> to confirm the frequency setting. | | | | | |

Preset Settings	The DEF1 and DEF2 preset settings are user defined settings. By default they are set to 50.00Hz and 60.00Hz, respectively. The MAX and MIN soft-keys set the frequency to the maximum and minimum, respectively.
-----------------	--

- | | | | |
|--|---------------------------------|---------------------------------|--|
| 4. Press the <i>F</i> key and set the desired frequency with the scroll wheel/keypad. | | | |
| <table border="1"> <tr> <td>Range</td> <td>45.00 ~ 500.0Hz (1000Hz option)</td> </tr> </table> | Range | 45.00 ~ 500.0Hz (1000Hz option) | |
| Range | 45.00 ~ 500.0Hz (1000Hz option) | | |
| 5. Press and hold the DEF1 or DEF2 soft-key until "Saved to DEF1/2" is displayed. This will save the frequency setting to the DEF1 or DEF2 soft-key. | | | |

Example

Frequency setting

Preset frequency settings

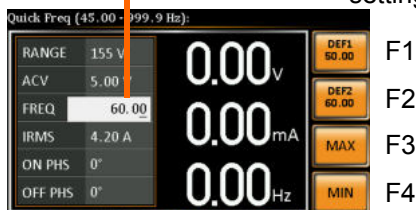

Note

Trying to set the frequency outside of the frequency limit will result in a frequency setting error being displayed on the screen.

The frequency can be set when the output is on.

Setting the Peak Current Limit

Background

Setting the peak current limit sets a limit on the current that can be sourced by the power supply. Once the output current over the setting, the output will set to off.



Note

When the peak current limit is tripped, an alarm will sound. Press Shift + 9 to clear the lpk alarm.

Shift+6 can also clear the lpk alarm. See page 74 for details.

Steps

1. Press *Shift* + *I rms* to access the Ipeak menu.

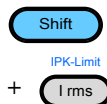

- Set the peak current with the scroll wheel/keypad or with the F3 ~ F4 soft-keys. The MAX and MIN soft-keys set the peak current to the maximum and minimum, respectively.

Range 10% ~ 100% peak current value. The peak current value depends on the selected voltage range.

Soft-keys MAX, MIN

- Press *Enter* to confirm the peak current setting.

Example

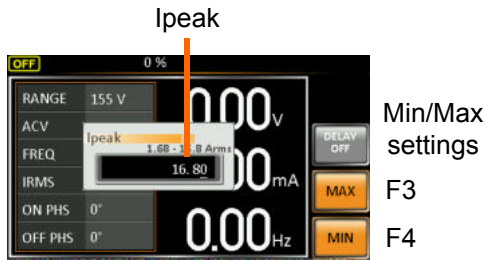

Delay Time Settings

The Delay Time setting essentially defines how long the measurement of the peak current must be sustained for before it is recognized. By default the delay time is turned off.

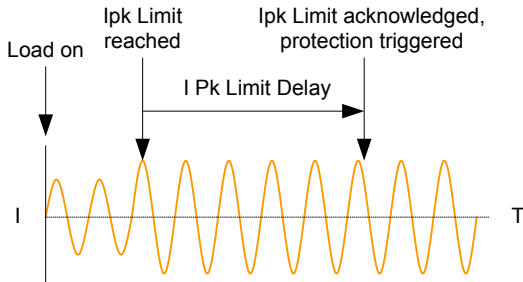

1. Press *Shift + I rms* and then press *DELAY[F2]*.
2. Set the desired delay time with the scroll wheel/keypad or with the F3 ~ F4 soft-keys. The MAX and MIN soft-keys set the delay time to the maximum and minimum, respectively.

Range 0(off) ~ 10 seconds

Soft-keys MAX, MIN

3. Press *Enter* to confirm the delay time setting.

Example

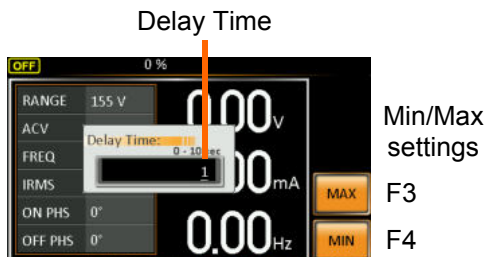

IPK Measurement Range Settings The IPK Range settings allow you to manually set the peak current measurement range. By default this setting is set to AUTO.

1. Press *Shift + I rms* and then press *IPK Range[F1]*.
2. Set the desired range with the scroll wheel.

Range AUTO, 0.28A, 1.4A, 14A, 70A
(APS-7050, APS-7100)

AUTO, 14A, 140A
(APS-7200, APS-7300)

3. Press *Enter* to confirm the IPK Range setting.

Example

IPK Range settings

APS-7050 & 7100

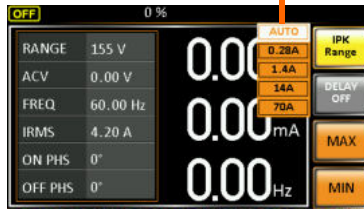

IPK Range settings

APS-7200 & 7300

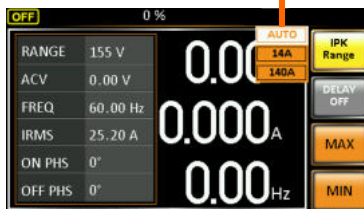

Note

When using manual IPK range setting, Irms measure range as below

Model	RMS Current Measurement
APS-7050 APS-7100	2.00 ~ 70.00mA (0.28A Range) 2.0 ~ 350.0mA (1.4A Range) 0.020 ~ 3.500A (14A Range) 0.02 ~ 17.50A (70A Range)
APS-7200 APS-7300	0.100 ~ 3.500A (14A Range) 0.10 ~ 35.00A (140A Range)

Setting the Current RMS Level

Background The *I rms* setting sets the root mean square current.

Setting the RMS current sets a limit on the current that can be sourced by the power supply. Once the output current over the setting, the output will set to off.

Steps

1. Press *I rms* to access the *I rms* menu. 
2. Set the *I rms* level with the scroll wheel/keypad or with the F3 ~ F4 soft-keys. The MAX and MIN soft-keys set the *I rms* level to the maximum and minimum, respectively.

Range 0.00 ~ full scale A (dependant on the voltage range)

Soft-keys MAX, MIN

3. Press *Enter* to confirm the current setting.

Example

I rms

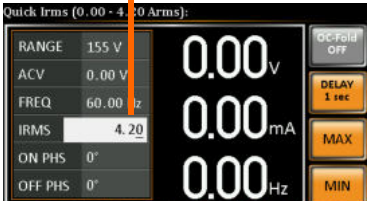

Min/Max settings
F3
F4



Note

Setting the *I rms* level to 0.00 will disable OCP and the OPP protection function is activated. The OPP is 105% of rating.

Setting the *I rms* to 0A is dangerous.

I rms Delay Time Settings The Delay Time setting defines how long the I rms measurement must be sustained for before it is recognized. By default the I rms delay time is turned off.

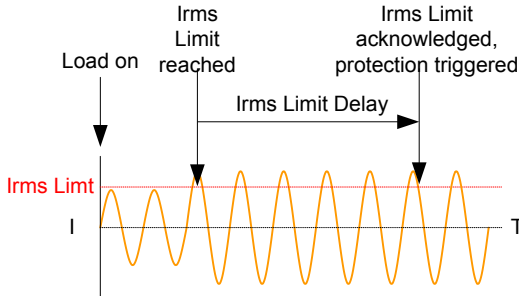

4. Press *I rms* and then press *DELAY[F2]*.
5. Set the desired delay time with the scroll wheel/keypad or with the F3 ~ F4 soft-keys. The MAX and MIN soft-keys set the delay time to the maximum and minimum, respectively.

Range 0(off) ~ 10 seconds

Soft-keys MAX, MIN

6. Press *Enter* to confirm the delay time setting.

Example

Delay Time

Min/Max settings
F3
F4

OC Fold Settings The over current fold back settings allow the APS-7000 to work as either a constant voltage source or a constant current source.

While the unit is sourcing less current than the I_{rms} current limit, the APS-7000 will act as a constant voltage source. In this mode, the voltage level will remain constant while the current level may vary. This is the normal operating mode.

When the current level reaches the I_{rms} limit, the APS-7000 will act as a constant current source. In this mode the current is constant and the voltage level varies. When the current subsides below the I_{rms} limit again, the unit will again act as a constant voltage source. When OC Fold is turned off, the APS-7000 will act as a current limiting power source when the I_{rms} limit has been reached.

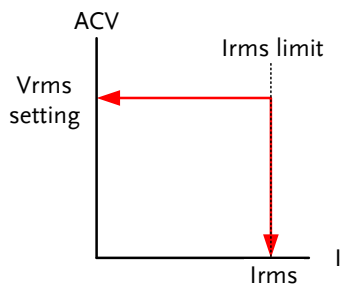

Note

OC-FOLD can only be active when the I_{rms} level is greater than 0.

7. Press I_{rms} and then press *OC-FOLD*[F1] toggle the OC-Fold function on or off.

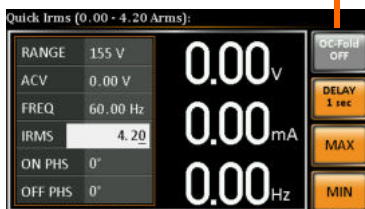

OC-Fold setting



Setting the On/Off Phase

Background The on phase setting sets the starting phase of the voltage output. The off phase setting sets the ending phase of the voltage output.

Steps

1. Press *Shift* + 7 or *Shift* + 4  the On Phase or Off Phase, respectively. +  or 

2. Set the *On Phase* or *Off Phase* setting with the scroll wheel/keypad or with the F3 ~ F4 soft-keys. The MAX and MIN soft-keys set the phase to the maximum and minimum, respectively.

Range 0 ~ 359°

Soft-keys MAX, MIN

3. Press *Enter* to confirm the phase setting.
-

Example

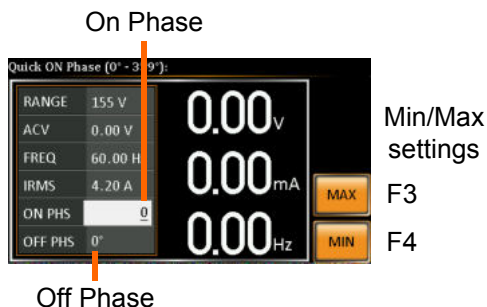

Alarm Clear

Background

The ALM CLR (Alarm Clear) function will clear any Over Power, Over Irms, Over Ipeak, Over Temperature, Output Short alarms and Remote Sense Error.

Applicable Alarms

OVER POWER, OVER IRMS, OVER IPEAK, OVER TEMPERATURE, OUTPUT SHORT, REMOTE SENSE ERROR.

Steps

1. Press *Shift* + 6 to clear any alarms.



Example

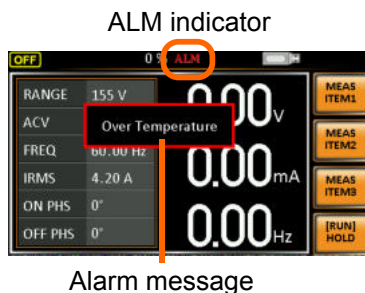

Display Modes

The APS-7000 power supply has two display modes. The standard display mode shows the power supply setup on the left and the 3 configurable measurements on the right. The simple display mode shows all measurement items available on the APS-7000.

Steps

1. Press the *Display* key.



2. The display mode will toggle each time the key is pressed.

Standard Mode

Settings Measurements

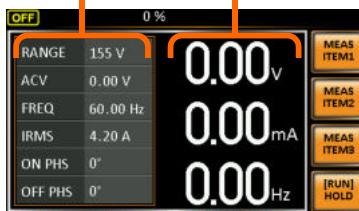

Configurable measurements

Hold measurement

Simple Mode

Measurement Items



Hold measurement

Configuring the Standard Mode Measurements

1. Press the Meas Item1, Item2 or Item3 soft-key.



2. Use the scroll wheel to select a measurement item and press Enter to confirm.

Sets first measurement item to Voltage

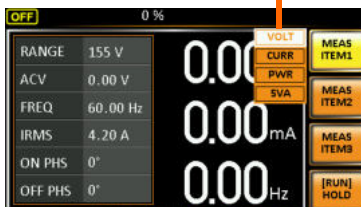

Hold Measurement

The Hold function will “hold” the current measurements on the display. Measurements won’t be updated on the display until the function is released.

Press HOLD[F4] to toggle hold on or off.

When APS-7000 rear terminal has detected reverser current, the display would change as follow:



Reverse Current Mode

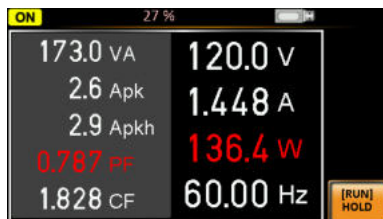

Panel Lock

The panel lock feature prevents settings from being changed accidentally. When activated, all keys and knobs except the Lock/Unlock key and the Output key (if active) will be disabled.

If the instrument is remotely controlled via the USB/LAN/RS-232/GPIB interface, the panel lock is automatically enabled. See page 151 for remote control details.

Activate the panel lock Press the *Lock* key to activate the panel lock. “Keys locked” appears on the display.



A lock icon will appear in the top corner when the panel keys are locked.



Disable the panel lock Hold the *Lock* key for ~3 seconds to disable the panel lock. “Keys unlocked” will appear on the display and the padlock icon will disappear.



(hold)

Example

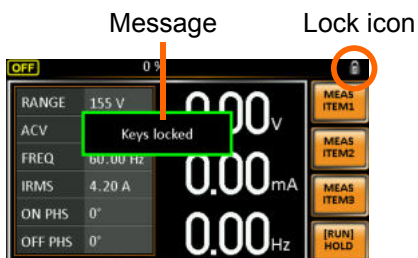

Turning the Output On

When the output is turned on, the DUT can be connected to either the rear panel output or the front panel output.



Warning

Both of these outputs are electrically linked. Only one DUT should be connected to any one of the outputs at a time. Using both outputs at the same time is not supported. Using the front and rear outputs at the same time could cause dangerous operating conditions. See page 34 for details about using the output terminals or sockets.

Turn Output On Press the *Output* key. The Output key will light up and ON will be displayed in the status bar to indicate that the output is on.



Turn Output Off Press the *Output* key. The Output key light will go out and OFF will be displayed in the status bar to indicate that the output is off.

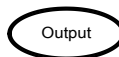

Using the remote sense (APS-7200 and APS-7300 only)

The APS-7200 and APS-7300 can be operated using local or remote voltage sense. By default, the power supply is configured for local sense.

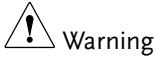

Warning

Ensure the output is off before handling the remote sense connectors.

Use sense cables with a voltage rating exceeding the isolation voltage of the power supply.

Never connect sensing cables when the output is on. Electric shock or damage to the power supply could result.

Remote sense connectors overview

The remote sense connectors are located at the rear panel of the APS-7200 and APS-7300.

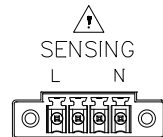

Local Sense

Local sense operation

When using local sense, the sensing terminals are not used. No compensation of any possible voltage drop seen on the load cables is performed. Local sense is only recommended when the voltage drop is of no consequence. By default, the power supply is configured for local sense.

1. Check that the remote sense setting is disabled (page 93).

Remote Sense

Remote sense operation

Remote sense is used to compensate for the voltage drop seen across load cables due to resistance inherent in the load cables. The remote sense function can compensate a maximum of 10% of the output voltage.



Warning

Ensure the output is off before handling the remote sense connectors.

Use sense cables with a voltage rating exceeding the isolation voltage of the power supply.

Never connect sensing cables when the output is on. Electric shock or damage to the power supply could result.

1. Configure the remote sense setting to ON (page 93).
2. Connect the Neutral terminal of the remote sense terminal block to the Neutral terminal of the load.
3. Connect the Live terminal of the remote sense terminal block to the Live terminal of the load.

Connection
example

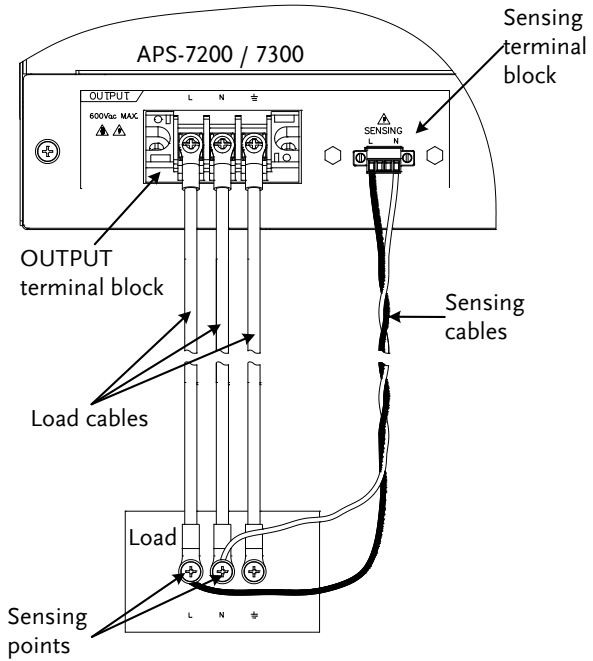

Advanced Settings

- Surge/Dip Control → from page 82
- Ramp Control → from page 85

Surge/Dip Control

Surge and dip control allows the power supply to source artificial surges or dips in voltage to a DUT. The surge/dip control feature provides a fast method to generate a surge/dip voltage event on a nominal voltage.

There have 4 parameters for configuring this feature: Mode selection (Mode), surge/dip voltage (ACV), the start time (T1) and testing duration (T2) of the surge/dip voltage period. The nominal voltage and frequency settings are based on the Basic Operation section.

Parameter Settings	Mode	Auto: When the output is on, this mode will automatically generate a trigger at 0° to keep the surge or dip event repeatedly on site.
		Manual: When the output is on, this mode will wait for the TRIG[F4] soft-key to be pressed before starting the surge or dip event on site.
		OFF: Disables surge/dip control.



Note

The magnitude of the surge/dip part of the resultant waveform depends on the surge/dip ACV setting level.

Triggering Site selection: The surge/dip site is selected as shown below.

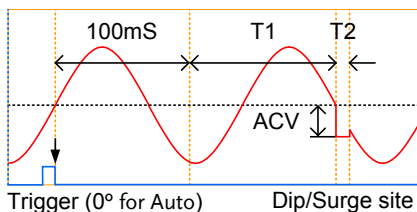

ACV Sets the ACV surge/dip level from the 0V level.

T1 Sets the T1 time.
 Range: 0~22ms(Auto Mode)
 Range: 0~99ms(Manual Mode)

T2 Sets the width of the surge/dip.
 Range: 0~22ms(Auto Mode)
 Range: 0~99ms(Manual Mode)

100mS Fixed 100mS delay after triggering.

Steps

1. Press the *Menu* key. The Menu setting will appear on the display. 
2. Use the scroll wheel to go to item 2, *Surge/Dip Control* and press *Enter*. Alternatively, use the short-cut key shift+8.
3. Go to the *Mode* setting using the scroll wheel and press *Enter*. Select the desired mode and press *Enter* again to confirm.

The Manual mode will allow you to manually trigger the surge/dip site. The Automatic setting will automatically trigger the surge/dip site.

Mode Manual, Auto, OFF

- Set the remaining parameters.
Note: these parameters are not visible when *MODE* is set to *OFF*.

Remaining parameters ACV, T1, T2

Exit

- Press *Exit*[F4] to exit from the Surge/Dip Control settings.



- After exiting the menu, the surge/dip control icon will appear in the status bar.



Triggering the Manual Surge/Dip Site

For the manual mode, the surge/dip site is determined by a manual trigger.

- Configure the nominal voltage and frequency settings. See the Basic Operation chapter for details. Page: 62, 64
- Turn the output on. The nominal settings above will be output. Page 78
- Press *Shift* to arm the trigger.



Press *TRIG*[F4] to generate the trigger manually via the front panel.



Or, OR
Alternatively, pulse the Trigger In pin Page 148
on the J1 connector high to generate the trigger.

Note

The TRIG soft-key is only available when the surge/dip control is set to *Manual*.

Ramp Control

The Ramp Control function controls how fast the voltage level ramps up and down. This function allows you to ramp the voltage as a unit of time or as a unit of voltage.

Parameter Settings

Time The Time setting allows you to set the ramp time as ms/Vrms.

$$T_{up} = \text{ramp up time}/1V_{rms}$$

$$T_{dn} = \text{ramp down time}/1V_{rms}$$

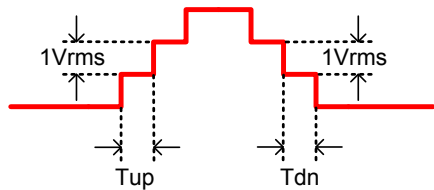

Voltage The Voltage setting allows you to set the ramp time as Vrms/ms.

$$V_{up} = \text{voltage up}/1ms$$

$$V_{dn} = \text{voltage down}/1ms$$

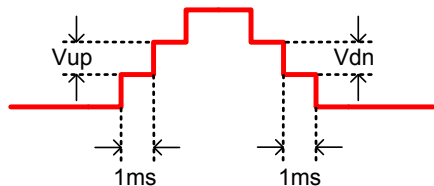

Steps

1. Press the *Menu* key. The Menu setting will appear on the display. 
2. Use the scroll wheel to go to item 3, *Ramp Control* and press *Enter*. Alternatively, use the short-cut key shift+5.

- Go to the *Mode* setting using the scroll wheel and press *Enter*. Select either *Voltage* or *Time* and press *Enter* again to confirm.

Mode	Voltage, Time
------	---------------

- For Voltage mode, set *Vup* and *Vdn*.

<i>Vup</i>	0.01 ~ 99.99Vrms
------------	------------------

<i>Vdn</i>	0.01 ~ 99.99Vrms
------------	------------------

- For Time mode, set *Tup* and *Tdn*.

<i>Tup</i>	0.1 ~ 999.9ms
------------	---------------

<i>Tdn</i>	0.1 ~ 999.9ms
------------	---------------

Exit

- Press *Exit[F4]* to exit from the Ramp Control settings.



- Upon exiting the ramp icon will appear in the status bar.



Example

Settings: Mode=Time, *Tup*=1 msec, VAC=100V, Freq=50Hz, Ramp output=on.

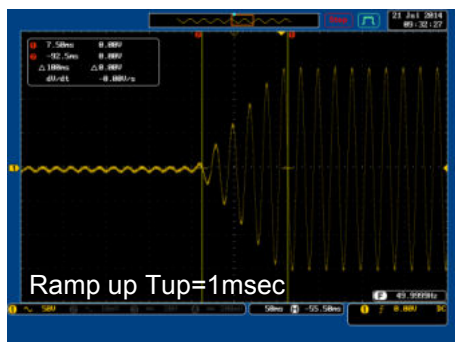

Example: Settings: Mode=Voltage, $V_{dn}=2V_{rms}$, $V_{AC}=100V$,
Freq=50Hz, Ramp output=off.

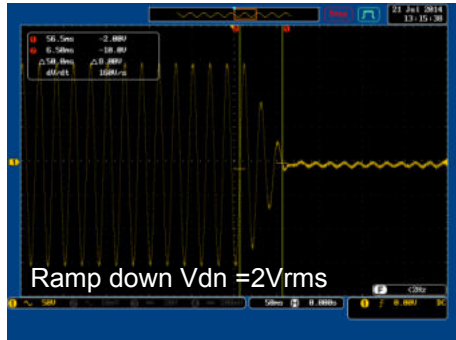

Miscellaneous

The Miscellaneous menu contains miscellaneous parameter settings.

- T Ipeak, hold → from page 88
- Power ON Output → from page 90
- Buzzer → from page 91
- SCPI Emulation → from page 92
- Remote Sense → from page 93 (for APS-7200 and APS-7300 only).

T Ipeak, hold

The T Ipeak, hold function sets the hold time for the peak current measurement. After the output is turned on, the APS-7000 will delay starting the peak current measurement by this hold time.

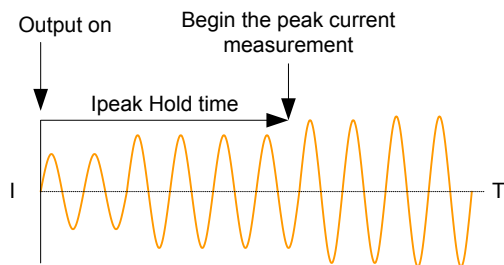

Steps

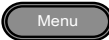
1. Press the *Menu* key. The Menu setting will appear on the display. 
2. Use the scroll wheel to go to item 4, *MISC Configuration* and press *Enter*.
3. Go to the *T Ipeak, hold(msec)* setting using the scroll wheel and press *Enter*. Set the time and press *Enter* again to confirm.

T Ipeak 1 ~ 60,000 ms

Exit

4. Press *Exit*[F4] to exit from the MISC Configuration settings.



Example



Settings

Power ON Output

The Power ON Output setting allows you to have the output turn on automatically after startup. The settings that are loaded are the last settings that were present in the standard mode before the unit was turned off last.

Steps

1. Press the *Menu* key. The Menu setting will appear on the display. 

2. Use the scroll wheel to go to item 4, *MISC Configuration* and press *Enter*.

3. Go to the *Power ON Output* setting using the scroll wheel and press *Enter*. Select a setting and press *Enter* to confirm.

ON	Set Output ON.
----	----------------

OFF	Set Output OFF.
-----	-----------------

SEQ	Execute the sequence that was loaded before the unit was last turned off.
-----	---

SIM	Execute the simulation that was loaded before the unit was last turned off.
-----	---

PROG	Execute the program that was loaded before the unit was last turned off.
------	--

Exit

4. Press *Exit[F4]* to exit from the MISC Configuration settings. 

Example

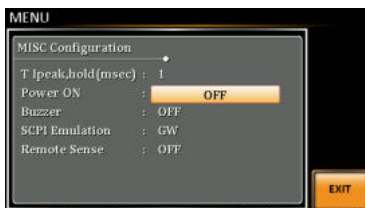

Settings

Buzzer

The Buzzer setting turns the buzzer sound on or off for key presses and alarms.

Steps

1. Press the *Menu* key. The Menu setting will appear on the display. 
2. Use the scroll wheel to go to item 4, *MISC Configuration* and press *Enter*.
3. Go to the *Buzzer* setting using the scroll wheel and press *Enter*. Turn the setting on or off and press *Enter* again to confirm.

Buzzer ON, OFF

Exit

4. Press *Exit*[F4] to exit from the MISC Configuration settings.



Example



Settings

SCPI Emulation

The SCPI Emulation setting supports both GW Instek as well as EXTECH SCPI remote commands. When set to EXTECH, the SCPI Emulation setting allows the APS-7000 to be a drop-in replacement for the EXTECH 6700 series by emulating the remote commands of the EXTECH units.

Steps

1. Press the *Menu* key. The Menu setting will appear on the display. 
2. Use the scroll wheel to go to item 4, *MISC Configuration* and press *Enter*.
3. Go to the *SCPI Emulation* setting using the scroll wheel and press *Enter*. Choose the SCPI emulation mode and press *Enter* again to confirm.

SCPI Emulation GW, EXTECH, N/A

Exit

4. Press *Exit[F4]* to exit from the MISC Configuration settings. 

Example



Settings

Remote Sense (APS-7200 and APS-7300 only)

The remote sense function detects the output voltage at the sensing input terminal. This function compensates for voltage drops across the load cables when the load is connected to the APS-7200 or APS-7300 over a long distance.



Note

The remote sense function can compensate a maximum of 10% of the output voltage. The maximum output voltage when compensation is used is limited by the rated voltage.

Steps

1. Press the *Menu* key. The Menu setting will appear on the display. 
2. Use the scroll wheel to go to item 4, *MISC Configuration* and press *Enter*.
3. Go to the *Remote Sense* setting using the scroll wheel and press *Enter*. Select the unit and press *Enter* to confirm.

Remote Sense ON, OFF

Exit

4. Press *Exit[F4]* to exit from the MISC Configuration settings. 

Example



Settings

Display

When the remote sense function is on, the displayed voltage value is the voltage measured at the sense terminal and the symbol “SV” is displayed next to the voltage reading on the standard and simple mode display.

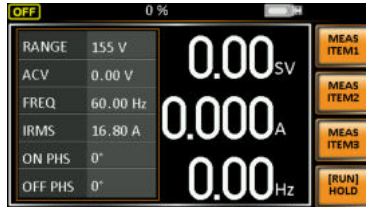

Display



Warning

Before connecting the remote sense cables, turn off the output and peripherals. Please see page 79 for more information on the remote sense cabling instructions.

If the remote sense wires are loose or falling, the display would show a message as below.

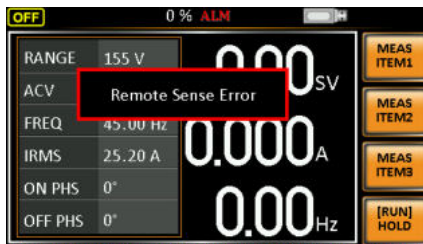

Trigger

The trigger settings are used to turn the output on or off or to set the behavior of the Trigger In and Trigger Out pins of the J1 Connector. The trigger can also be used in conjunction with the Sequence mode, Simulation mode and Surge/Dip mode. See page 148 for further details.

Pin Assignment
(APS-7050 and
APS-7100)

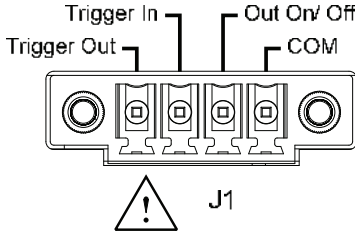

Pin Assignment
(APS-7200 and
APS-7300)

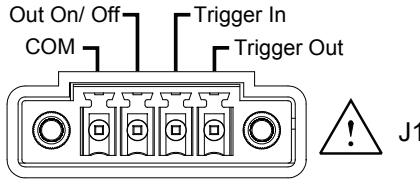

Trigger Control Settings

The trigger control menu sets both the trigger in and the trigger out behavior of the J1 connector.



Note

The following trigger control settings are not applicable when in the Simulation test mode or the Sequence test mode.

Steps

1. Press *Shift* + 2 to access the Trigger Control menu.

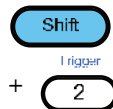

2. The trigger control settings appear. The settings are divided into Input Pin and Output Pin.

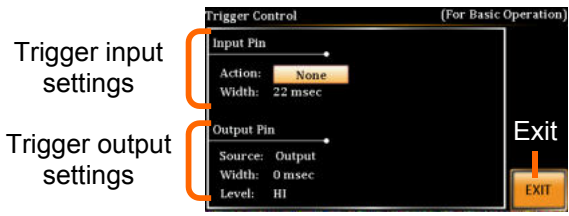

Trigger input settings

Trigger output settings

Trigger Input Pin 1. The Input Pin settings configure what action is taken when the Trigger In pin on the J1 connector is high.

2. Go to the *Action* setting using the scroll wheel and press *Enter*. Choose what will happen when the Trigger In pin is pulsed high(+5V) and then press *Enter* to confirm.

None	No action is taken. Remote trigger commands are accepted.
Output	Turns the output on or off when triggered.
Setting	Sets a user-defined voltage and frequency setting when triggered.
Preset	Loads a preset setting when triggered.
Surge Dip	Triggers the surge/dip control.

3. Go to the Width setting and set the minimum pulse width to recognize the trigger input pulse.

0	Minimum pulse width (5ms)
1~ 60ms	1~ 60ms pulse width.

4. If Output was chosen, set output status.

Status	ON, OFF
--------	---------

5. If Setting was chosen, Set Vset and Fset.

Vset	0 ~ full scale voltage (dependent on the chosen range; 600V optional)
------	---

Fset	45.00 ~ 500.0 Hz (1000Hz optional)
------	------------------------------------

6. If Preset was chosen, choose which preset setting should be loaded when the Trigger Input is set to high(+5V).

Memory	0 ~ 9
--------	-------

Trigger Output Pin

7. Go to the *Source* setting to choose what function or test mode will be able to the trigger the output pin to pulse high.

None	No source is able to use the trigger output. Remote trigger commands are accepted.
------	--

Output	The trigger output pin is activated when the output is turned on or off.
--------	--

Setting	When the settings change the trigger output pin is activated.
---------	---

Preset	When a preset is loaded or saved, the trigger output pin is activated.
--------	--

All	The trigger output pin is activated when any of the settings, presets or the output are changed.
-----	--

8. Go to *Width* to set how long the trigger output pin is pulsed high for.

Width	1 ~ 60ms
-------	----------

	0ms: Stays high/low.
--	----------------------

9. If Width, above, was set 0ms, you can choose the output pin polarity with the Level parameter. This setting will pull the output pin high or low when source condition is true. This setting is not available when Width is set to 1~60ms.

Level HI ($\geq+2V$), LO ($\leq+0.8V$)

Exit

10. Press *Exit*[F4] to exit from the Trigger Control settings.



[1] Remote Control Commands

The following remote control commands are applicable for the trigger input or output. See the programming manual for usage details.

*TRG

:INITiate[:IMMediate]:NAME

:INITiate[:IMMediate][:TRANsient]

:MEMory:SAV

:MEMory:RCL

:MEMory:TRIGgered

:MEMory:TRIGgered?

:OUTPut[:STATe]:TRIGgered

:OUTPut[:STATe]:TRIGgered?

:SYSTem:CONFigure:TRIGger:INPut:MODE

:SYSTem:CONFigure:TRIGger:INPut:MODE?

:SYSTem:CONFigure:TRIGger:INPut:SOURce

:SYSTem:CONFigure:TRIGger:INPut:SOURce?
:SYSTem:CONFigure:TRIGger:OUTPut:MODE
:SYSTem:CONFigure:TRIGger:OUTPut:MODE?
:SYSTem:CONFigure:TRIGger:OUTPut:SOURce
:TRIGger:OUTPut:SOURce
:TRIGger:OUTPut:SOURce?
:TRIGger:OUTPut[:IMMediate]
:TRIGger:MEMory:SOURce
:TRIGger:MEMory:SOURce?
:TRIGger:MEMory[:IMMediate]
:TRIGger[:TRANsient]:SOURce
:TRIGger[:TRANsient]:SOURce?
:TRIGger[:TRANsient][:IMMediate]
[:SOURce]:FREQuency:TRIGgered
[:SOURce]:FREQuency:TRIGgered?
[:SOURce]:VOLTage[:LEVel]:TRIGgered[:AMPLitude]
[:SOURce]:VOLTage[:LEVel]:TRIGgered[:AMPLitude]?



Preset Settings

- Save Presets to Local Memory → from page 100
- Recall Presets to Local Memory → from page 101
- Manage Preset Settings → from page 102

Save Preset Settings to Local Memory

Up to 10 preset settings can be saved to internal memory.

Steps

1. Press *Preset* and then hold a  *number key (0~9)* to save the present settings to the corresponding memory number.  +  (hold)

Presets	M0 ~ M9
---------	---------

2. Press the *Preset* key again to exit from the preset mode.
-

Example

For example, pressing *Preset* & holding 1 will save the present settings to memory slot 1 (saved to M1).



Note

The preset key will become green when active. A beep will be heard (Buzzer set to ON) and a message will be displayed when the settings are saved.

Load Preset Settings to Local Memory

Any of the 10 preset settings can be recalled from internal memory.

- Steps
1. Press *Preset* and press a *number key*(0~9) to load the corresponding memory number.

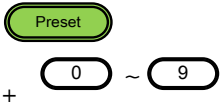

Presets	M0 ~ M9
---------	---------
 2. Press the *Preset* key again to exit from the preset mode.
-

Example For example, pressing *Preset* + 1 will recall the saved settings from memory slot 1 (recalled from M1).



Note

The preset key will become green when active. A beep will be heard and a message will be displayed when the settings are recalled.

Manage Preset Settings

Preset settings can be easily saved to or from a USB flash drive using the Save/Recall Files utility in the Menu system. Files can also be deleted from local memory using the utility.

File Format When files are saved to USB they are saved in the following format:
 presetX.set, where X is the memory number M0 ~ M9. The files are saved to USB:/gw.

When files are recalled from USB, files must be recalled from the same memory number. For example, the file preset0.set can only be recalled to memory number M0. The files can only be recalled from the USB:/gw directory.

Steps

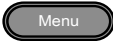
1. Press the *Menu* key. The Menu settings will appear on the display. 
2. Use the scroll wheel to go to item 12, *Save/Recall Files* and press *Enter*.
3. Go to the *Type* setting using the scroll wheel and press *Enter*. Select *Preset* and press *Enter* to confirm.
4. Go to the *Action* setting and choose the file operation and then press *Enter*.

MEM→USB Saves the selected preset memory from the local memory to a USB flash drive.

MEM←USB Loads a preset memory from a USB flash drive to the selected local memory.

DELETE(MEM) Deletes the selected preset memory from local memory.

5. Go to the *Memory No.* setting and select the preset memory number to perform the operation on. Press *Enter* to confirm.
-

Memory No. 0 ~ 9 (M0 ~ M9)

Execute File
Operation

6. Press *Exe[F1]* to perform the file operation.



Exit

7. Press *Exit[F4]* to exit from the *Save/Recall Files* settings.



Example



Settings

Arbitrary Waveform Function

The ARB function is able to select a large range of continuous arbitrary waveforms. There are a number of basic waveform shapes to choose from, each of which can be customized to output a waveform with your desired attributes.

The ARB function can be used in conjunction with the Simulate and Sequences modes, but cannot be used with the Program test modes. When the WAVE parameter is set to any waveform other than SINE, ARB will be shown in the status bar when in the BASIC operation, Simulate mode or Sequence mode to indicate that the ARB function is active when in these modes.



Note

The output will always be turned off if the ARB waveform is changed. It is not possible to keep the output on whilst the type of ARB waveform is changed.

- ARB Function Overview → from page 105
- Selecting an ARB Waveform → from page 108

ARB Mode Overview

Background The ARB mode function has 7 basic waveforms and a number of settable attributes, depending on the chosen waveform.

Setting Screen Overview

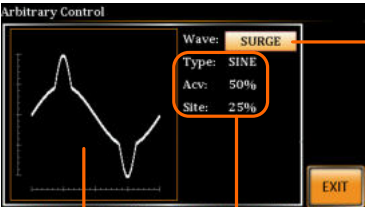

Waveform type

F4 Exit

Visual representation of the waveform shape and its attributes

Attributes for the selected waveform

ARB Waveform Overview

The following describes each of the 7 basic waveforms.

Sine This is the default waveform used for the APS-7000. No settable attributes.

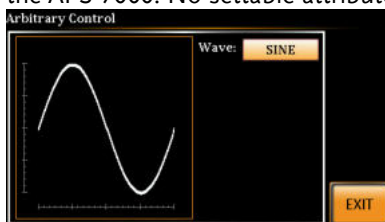

Triangle Basic triangle waveform has a settable number of percentage.

Attributes:
Sym%: 0 ~ 100%

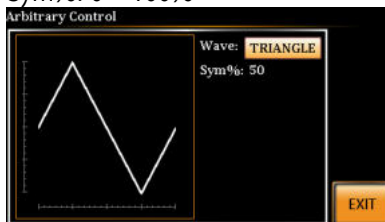

Staircase The staircase waveform has a settable number of step levels.

Attributes:

Stairs: 1 ~ 100

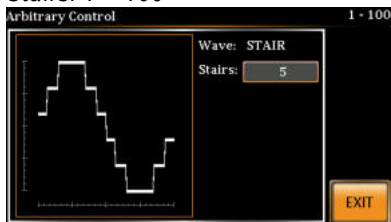

Clip Outputs a clipped sinewave. The degree to which the sine wave is clipped is settable.

Attributes:

Ratio: 0.50 ~ 0.99

RMS: RATIO/KEEP



CF Crest factor waveform. The crest factor is settable.

Attributes:

CF: 1.4 ~ 10.0

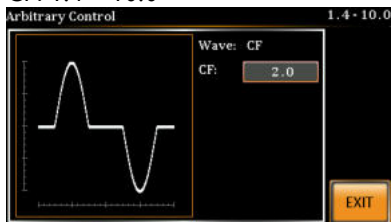

- Surge The surge waveform has a settable ACV base level, site size and site shape.
- Attributes:
 Type: Sine, Square (site waveform type)
 Acv: 0 ~ 100% (base waveform ampl.)
 Site: 0 ~ 100% (site waveform width)

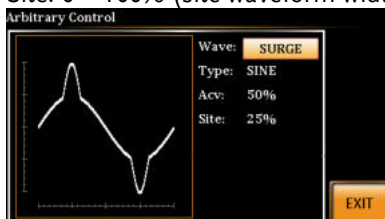

- ARB The ARB waveform shape function simply adds a number Fourier series terms to create an arbitrary waveform.
- Attributes:
 Type: 1 ~ 22 (Number of selectable ARB waveforms)



The numerical figures shown under the Type parameter shows which Fourier series terms are used and their (bn) coefficients.

Selecting an ARB Waveform

Entering the ARB Menu

1. Press *Shift* + 1 to access the ARB menu.

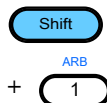

2. Set the *Wave* parameter with the scroll wheel and confirm the setting with the *Enter* key.

Wave	Sine, Triangle, Stair, Clip, CF, Surge, ARB
------	---

3. Use the scroll wheel and *Enter* key to select any other attributes for the selected waveform and press *Enter* to confirm any settings.

Other Attributes:

Sine Wave:	None
------------	------

Triangle Wave:	None
----------------	------

Stair:	Stairs: 1 ~ 100
--------	-----------------

Clip:	N*ACV: 1 ~ 10
-------	---------------

CF:	CF: 1.4 ~ 10.0
-----	----------------

Surge:	Type: Sine, Square ACV: 0 ~ 100% Site: 0 ~ 100%
--------	---

Exit

4. Press *Exit*[F4] to exit from the ARB settings.



Common Settings

5. Press *Menu* to go back to the main menu.

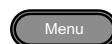

6. Set the voltage, frequency, Irms level and so on as you normally would for the standard ACV output. See the Basic Operation chapter for setting details.



Note

When the WAVE parameter is set to any waveform other than SINE, **ARB** will be shown on the display when in the BASIC operation, Simulate mode or Sequence mode to indicate that the ARB function is active when in these modes.

Standard Mode Example

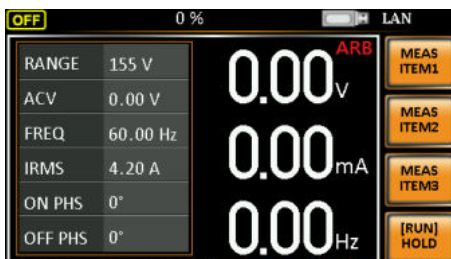

Simple Mode Example



Sequence Example



Simulate Example

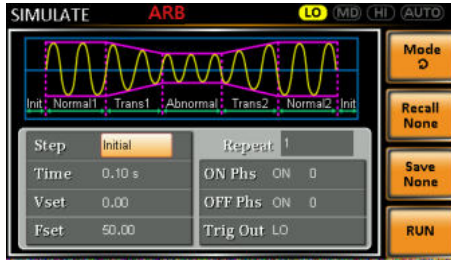

Test Mode Function

There are three test modes.

- Simulate Mode: voltage/frequency fluctuations.
The Simulate function is a quick and easy way to simulate fluctuations in voltage, frequency, phase and other anomalies in mains supply power.
 - Sequence Mode: creates test sequences.
The Sequence function creates arbitrary AC waveforms based on user defined parameters.
 - Program Mode: Runs a group of test sequences.
The Program function runs different memory steps sequentially. Each step of a program is a preset memory configuration (M01 ~ M50). The Program function can also perform pass/fail testing.
- Simulate Mode Overview → from page 112
 - Simulate Settings → from page 116
 - Save Simulation to Local Memory → from page 119
 - Recall Simulation from Local Memory → from page 119
 - Manage Simulation Settings → from page 120
 - Run Simulation → from page 122
 - Sequence Mode Overview → from page 124
 - Sequence Settings → from page 128
 - Save Sequence to Local Memory → from page 132
 - Recall Sequence from Local Memory → from page 132
 - Manage Sequence Settings → from page 133
 - Run Sequence → from page 135
 - Program Mode Overview → from page 137
 - Save a Program to Local Memory → from page 144
 - Recall a Program from Local Memory → from page 144
 - Manage Program Settings → from page 145

Simulate Mode Overview

Background The Simulate function is used to test power supply fluctuation. This function is able to simulate common abnormalities in mains power such as fluctuations in voltage, phase and frequency. These simulations can be run as one-off anomalies or cyclic anomalies.

Setting Screen Overview

The screenshot shows the SIMULATE screen with a waveform graph at the top. Below the graph is a table of settings:

Step	Initial	Repeat
Time	0.10 s	ON Phs ON 0
Vset	0.00	OFF Phs ON 0
Fset	50.00	Trig Out LO

Callouts from the image:

- Number of repetitions**: Points to the 'Repeat' column header.
- V RANGE**: Points to the 'Vset' parameter.
- Test mode**: Points to the 'Mode' button.
- Recall test**: Points to the 'Recall None' button.
- Save test**: Points to the 'Save None' button.
- Run test**: Points to the 'RUN' button.
- Step Frequency**: Points to the 'Fset' parameter.
- Step voltage**: Points to the 'Vset' parameter.
- Step time**: Points to the 'Time' parameter.
- Step**: Points to the 'Step' column header.
- ON/OFF phase**: Points to the 'ON Phs' and 'OFF Phs' parameters.
- Trigger output level**: Points to the 'Trig Out' parameter.

Step Overview The Simulate function is comprised of 6 steps. Each step is run sequentially in the following order: Initial, Normal1, Trans1, Abnormal, Trans2, Normal2, Initial.

Initial	The Initial step is used as the initial and final settings of the waveform simulation. This is the standby step before the test starts and the standby step after the test ends.
Normal1	This step configures the normal output conditions that precede the abnormal conditions.

Trans1	This step configures the transition from normal to abnormal conditions. This step will linearly interpolate the normal settings to the abnormal settings. This step can be skipped for abrupt state changes.
Abnormal	This step contains the abnormal conditions for the simulation.
Trans2	This step configures the transition from abnormal to normal conditions.
Normal2	This step configures the normal conditions that supersede the abnormal conditions.

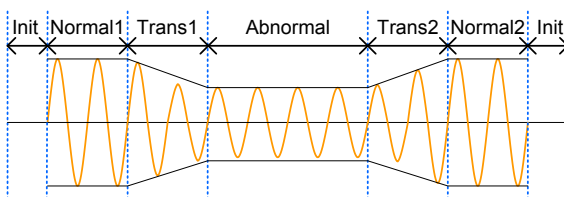

Parameter Overview

The following table shows which parameters are available for each step.

Step\Parameter	Initial	Normal1	Trans1	Abnormal	Trans2	Normal2
Repeat	✓	✓	✓	✓	✓	✓
Time	✓	✓	✓	✓	✓	✓
ON Phs	✓	✓	X	✓	X	✓
OFF Phs	✓	✓	X	✓	X	✓
Vset	✓	✓	X	✓	X	✓
Fset	✓	✓	X	✓	X	✓
Trig Out	✓	✓	✓	✓	✓	✓

Repeat	Indicates the number of times the simulation will be run, from Normal1 to Normal2. A value of 0 indicates infinite repeats. The repeat setting is the same for each step.
Time	Sets the duration time of the step. When the ON Phs=ON, the total duration of the step is equal to the Time setting + ON Phs=ON duration.
ON Phs	Sets the starting phase of the waveform for the step. Not applicable for the Trans 1/2 steps.
OFF Phs	Sets the off phase of the waveform after the output has been turned off. Not applicable for the Trans 1/2 steps.
Fset	Sets the frequency of the step. Not applicable for the Trans 1/2 steps.
Vset	Sets the voltage of the step. Not applicable for the Trans 1/2 steps.
Trig Out	Sets the polarity of the trigger out port for the duration of the step. The trigger out signal is sent at the start of each step (including the first initial step).

The following diagram illustrates the relationship between each of the parameters in a step.

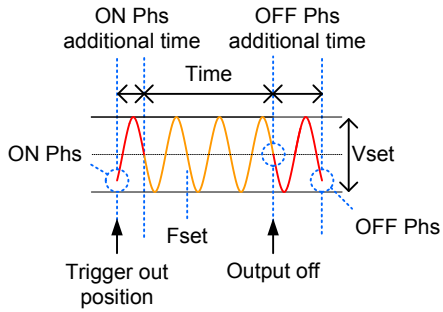

Simulate Settings

Entering the Simulate Menu

1. Press *Test*.

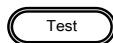

2. Press *Mode[F1]* and use the scroll wheel to select *SIMULATE* and then press *Enter*.

Simulate Mode

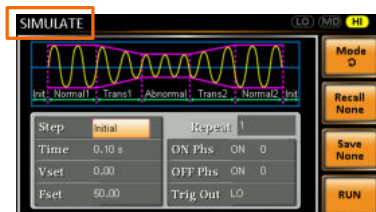

F1 Mode

Steps

3. Use the scroll wheel to go to the *Step* setting and press *Enter*.
4. Use the scroll wheel to select one of the simulation steps and press *Enter*.

Steps	Initial, Normal1, Trans1, Abnormal, Trans2, Normal2
-------	---

5. Go to the *Time* setting and set the duration of the step.

Time	0.01 ~ 999.99s, 0(Trans 1 and Trans2) Note: For Trans1 and Trans2, it supports a value of 0, which will skip the step.
------	---

6. Go to the *ON Phs* setting and set the starting phase of the step. Not applicable for Trans1 or Trans2.

ON Phase	ON, OFF
----------	---------

ON Phase	0~ 359°
----------	---------

Resolution	1°
------------	----

7. Go to the *OFF Phs* setting and set the end phase of the step. Not applicable for Trans1 or Trans2.

OFF Phase	ON, OFF
-----------	---------

OFF Phase	0~ 359°
-----------	---------

Resolution	1°
------------	----

8. Press the *Range* key repeatedly to set the voltage range for the *Vset* parameter. The range will be shown in the top corner, which indicates that the simulation will be executed within this voltage range.



Range	LO(155V), MD(310V), HI(600V, optional)
-------	--



Note

In several cases, time will be inconsistent with setting when Auto Range is executed. Hence, except for specific case, if any, please select a fixed Range.

9. Go to the *Vset* setting and set the *Vrms* level of the step. If you input a *Vset* value that is not within the voltage range, the input value will be ignored.

Not applicable for Trans1 and Trans2.

<i>Vset</i>	0.00 ~ 310.0Vrms (range dependent) (600V optional)
-------------	---

10. Go to the *Fset* setting set the frequency of the step. Not applicable for Trans1 and Trans2.

Fset	45.00 ~ 500.0Hz (1000Hz optional)
------	-----------------------------------

11. Go to the *Trig Out* setting and set the state of the trigger out pin at the start of each step.

Trig Out	HI, LO
----------	--------

12. Lastly, go to the *Repeat* parameter select the number of times the simulation will repeat the Normal1-Trans1-Abnormal-Trans2-Normal2 sequence of steps. A value of 0 will set the number of repetitions to infinite.

Repeat	1 ~ 9999, 0(infinite)
--------	-----------------------

Save a Simulation to Local Memory

Saving a Simulation	Simulation settings can be saved to one of 10 memory slots (SIM0 ~ SIM9).
Steps	<ol style="list-style-type: none">1. Press <i>Save</i>[F3] and then long press a <i>number key</i> when prompted.2. A message will appear when the save is successful. <hr/>
	Save SIM0 ~ SIM9

Recall a Simulation from Local Memory

Recall a Simulation	Simulation settings can be recalled from one of 10 memory slots (SIM0 ~ SIM9).
Steps	<ol style="list-style-type: none">1. Press <i>Recall</i>[F2] and then press a <i>number key</i> when prompted.2. A message will appear when the settings are recalled successfully. <hr/>
	Recall SIM0 ~ SIM9

Manage Simulation Settings

Simulation settings can be easily saved to or from a USB flash drive using the Save/Recall Files utility in the Menu system. Files can also be deleted from local memory using the utility.

File Format When files are saved to USB they are saved in the following format:
simX.sim, where X is the memory number 0 ~ 9 (SIM0 ~ SIM9). The files are saved to USB:/gw.

When files are recalled from USB, files must be recalled from the same memory number. For example, the file sim0.sim can only be recalled to memory number SIM0. The files can only be recalled from the USB:/gw directory.

Steps

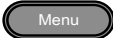
1. Press the *Menu* key. The Menu settings will appear on the display. 
2. Use the scroll wheel to go to item 12, *Save/Recall Files* and press *Enter*.
3. Go to the *Type* setting using the scroll wheel and press *Enter*. Select *SIMULATE* and press *Enter* to confirm.
4. Go to the *Action* setting and choose the file operation and then press *Enter*.

MEM→USB Saves the selected simulation memory from the local memory to a USB flash drive.

MEM←USB Loads the simulation memory from a USB flash drive to the selected local memory.

DELETE(MEM) Deletes the selected simulation memory from local memory.

5. Go to the *Memory No.* setting and select the simulation memory number to perform the operation on. Press *Enter* to confirm.

Memory No. 0 ~ 9 (SIM0 ~ SIM9)

Execute File Operation

6. Press *Exe[F1]* to perform the file operation.



Exit

7. Press *Exit[F4]* to exit from the *Save/Recall Files* settings.



Example

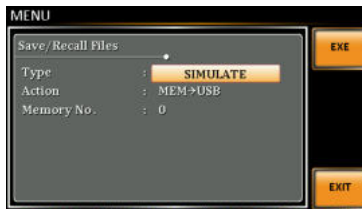

Settings

Running a Simulation

Background When running a simulation, the display changes to the simulate run view.

Run Screen Overview

The screenshot shows the 'SIMULATE' screen with the following layout:

- Settings:** A box at the top contains 'VSET 110.0 V', 'FREQ 50.00 Hz', 'ON Phase 0°', and 'OFF Phase 0°'. An arrow points from the 'Settings' label to this box.
- Step X of Y:** '3/5' is displayed in the top right corner.
- Readback measurements:** A box at the bottom contains '110.0 V', '0.00 mA', '50.00 Hz', '0.00 W', '0.000 CF', and '0.0 Ap'. An arrow points from the 'Readback measurements' label to this box.
- Buttons:** 'HOLD' and 'STOP' buttons are on the right. 'HOLD' is labeled 'Hold/Conti test' and 'STOP' is labeled 'Stop/Run test'.

Note

Ap of readback measurements that is mean peak current (Apk)

Steps

1. Press *Output*.



2. Press *Run[F4]*. The test will start to run.

The settings of the current step will be shown at the top of the screen and the measurement readout will be shown on the bottom of the screen.

The top-right of the screen will display the current step number of the simulation.

- | | |
|----------------|--------------|
| 1/5 = Normal1 | 2/5 = Trans1 |
| 3/5 = Abnormal | 4/5 = Trans2 |
| 5/5 = Normal2 | |

3. The test will continue to run until the last repeat step has run, *Stop*[F4] is pressed or the output is turned off*. When the test has finished/stopped, the screen will return to the original settings screen.

* If the OFF-phase has been set, the output will continue until the OFF-phase setting is satisfied.

Hold Test	To pause the test mid-way, press <i>Hold</i> [F3].
-----------	--

Continue Test	To continue a paused test, press <i>Conti</i> [F3].
---------------	---

Sequence Mode Overview

Background The Sequence function creates wholly AC arbitrary waveforms. These waveforms are made from a number of steps that when run creates an arbitrary waveform.

A Sequence function can be comprised of up to 255 steps.

Setting Screen Overview

The screenshot shows the SEQUENCE screen with the following parameters and callouts:

- Branch 1**: Points to the Branch 1 field.
- Jump To**: Points to the Jump To field.
- Step number**: Points to the Step field.
- Step time**: Points to the Time field.
- Jump count**: Points to the Jump Cnt field.
- Branch 2**: Points to the Branch 2 field.
- V RANGE**: Points to the V RANGE field.
- Test mode**: Points to the Mode field.
- Recall test**: Points to the Recall None button.
- Save test**: Points to the Save None button.
- Run test**: Points to the RUN button.
- Voltage**: Points to the V RANGE field.
- On Phase**: Points to the ON Phis field.
- Step Termination**: Points to the Term field.
- Trigger polarity**: Points to the Trig Out field.
- OFF Phase**: Points to the OFF Phis field.
- Frequency**: Points to the Fset field.

Sequence Parameter Overview

The Sequence function is comprised of a minimum of 2 steps that are executed in user defined sequences.

Each step can have different step times, voltage levels, start phases, stop phases and frequencies.



Step 0 is assigned as a “Standby” step. At the end of the test the unit will shift to the standby step.

Step Assigns the step number.

Time	Sets the step duration time. This step time is exclusive of any transition time needed to match start phases. See the diagram on page 126 for details.
Jump To	The Jump To setting determines which step to jump to at the end of the step. If Jump To is turned off, the unit will follow the Term (Step termination) setting for the step.
Jump Cnt.	Determines the number of times to loop the jump step.
Branch1/ Branch2	The Branch settings allow you to make a selectable branch within the sequence when the sequence is running or on hold. The branch1 or branch2 actions are enabled by pressing the F1 or F2 function keys, or by using the :TRIG:SEQ:SEL:EXEC remote control command. After the branch step(s) have completed the unit will return back to the step from which the branch was executed and continue to run the step from where it left off.
Term	Determines the step termination settings at end of the step. The CONT setting tells the sequence to go to the next step. The HOLD setting will pause the output at the end of the step and will only continue to the next step when CONT[F3] is pressed. The END setting will end the sequence and go to Step 0(standby step).

Trig Out	Sets the polarity for the trig out pin on the J1 connector when the step is running.
ON/OFF Phs	<p>Sets the start and stop phase of the AC waveform. The ON Phs setting sets the starting phase <i>of the step</i>.</p> <p>OFF Phs sets the off phase <i>for the output</i> when the output is turned off.</p>
Vset	<p>Sets the AC voltage level. There are 4 secondary voltage settings that determine how the voltage is output.</p> <p>Constant: Sets the voltage level of the step immediately to Vset values.</p> <p>Keep: Sets the voltage level to “keep” the voltage of the previous step.</p> <p>Sweep: Linearly increases or decreases the values from the end of the previous step to the end of the current step.</p>
Voltage Range	There are 4 voltage range settings: HI range (0~600VAC), MD range (0~310VAC), LO range (0~155VAC), Auto
Fset	Sets the frequency of the step.

Sequence Example

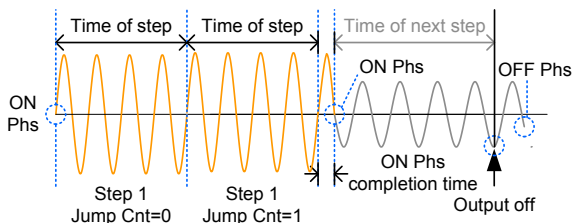

Sequence Flow
Example

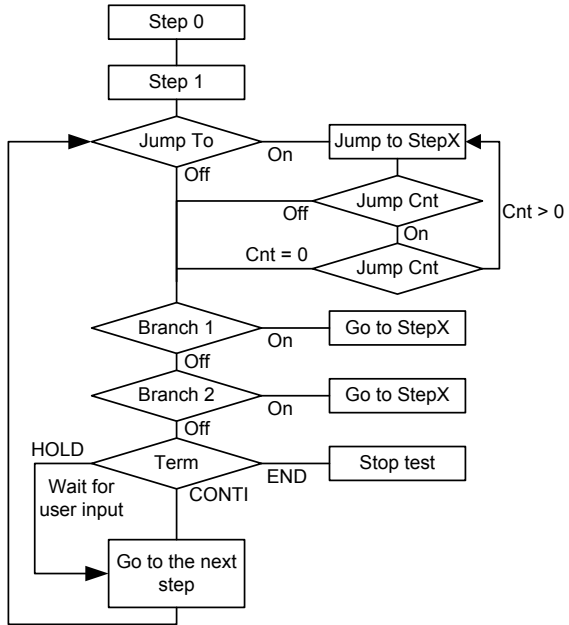

Sequence Settings

Entering the Sequence Menu

1. Press *Test*.

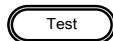

2. Press *Mode[F1]* and use the scroll wheel to display *Sequence Mode* and then press *Enter*.

Sequence Mode Voltage range

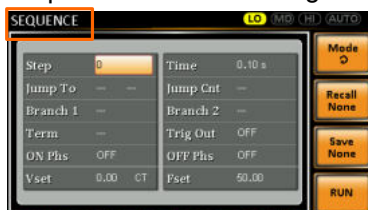

Steps

3. Use the scroll wheel to go to the *Step* setting and press *Enter*.
4. Use the scroll wheel to select the step number. 0 is always the starting step for the sequence.

Step	0 ~ 255
------	---------

5. Go to the *Time setting* and set the duration of the step.

Time	0.01 ~ 999.99s
------	----------------

6. Go to the *Jump To* setting and choose which step to jump to, or turn the setting off.

Step	ON, OFF, 0 ~ 255
------	------------------

7. Go to the *Jump Cnt* setting and set the number of times the current step will loop.

Jump Cnt 1 ~ 255, 0

Note: A setting of 0 will set the number of jumps to infinite.

8. Go to the Branch 1/2 setting and set a step to branch to.

Branch 1, 2 ON, OFF, 0 ~ 255

9. Go to the *Term* setting and set the step termination setting. CONTI will automatically go to the next step at the end of the step. END will return to step 0. HOLD will stay at the current step until you allow the sequence to continue to the next step.

Term CONTI, END, HOLD

10. Go to the *Trig Out* setting and set the output state of the trigger out pin when the step has started.

Trig Out HI, LO

11. Go to the *ON Phs* setting and set the starting phase of the step.

ON Phase ON, OFF

ON Phase 0~ 359°

Resolution 1°

12. Go to the *OFF Phs* setting and set the end phase of the step.

OFF Phase ON, OFF

OFF Phase 0~ 359°

Resolution 1°

- Press the *Range* key repeatedly to set the voltage range for the *Vset* parameter. The Range will be shown in the top corner.



Range	LO(155V), MD(310V), HI(600V, optional), Auto
-------	--

- Go to the *Vset* setting and set the output voltage for the step. If the input setting voltage doesn't appear in the selected voltage range, an "Over Range" alarm will appear during Sequence. At this time, the output voltage maintains on the previous setting voltage value.

<i>Vset</i>	0 ~ 310V (range dependent) (600V optional)
-------------	---

Secondary settings	CT (Constant), KP (Keep), SP (Sweep)
--------------------	--------------------------------------

Note: Step 0 can only be set to CT or SP.



Note

When output has been executed under Standard Mode, press the [Test] key to enter Sequence Mode, and then execute step 0 to set output value.

- Go to the *Fset* setting and set the frequency of the step.

<i>Fset</i>	45.00 ~ 500.0Hz(1000Hz optional)
-------------	----------------------------------

Example Test

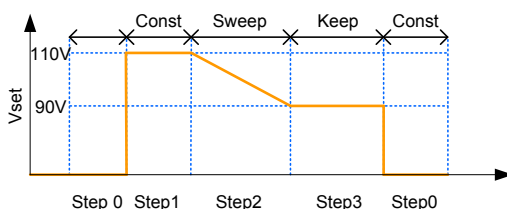

The example above shows how the secondary voltage settings affect how the voltage is output in each step.

Step no.	0	1	2	3
Vset (V)	0	110	90	N/A
2 nd Setting	CT	CT	SP	KP

Save a Sequence to Local Memory

Saving a Sequence Sequence settings can be saved to one of 10 memory slots (SEQ0 ~ SEQ9).

- Steps
1. Press *Save*[F3] and then long press a *number key* when prompted.
 2. A message will appear when the save is successful.
-

Save SEQ0 ~ SEQ9

Recall a Sequence from Local Memory

Recall a Sequence Sequence settings can be recalled from one of 10 memory slots (SEQ0 ~ SEQ9).

- Steps
1. Press *Recall*[F2] and then press a *number key* when prompted.
 2. A message will appear when the settings are recalled successfully.
-

Recall SEQ0 ~ SEQ9

Manage Sequence Settings

Sequence settings can be easily saved to or from a USB flash drive using the Save/Recall Files utility in the Menu system. Files can also be deleted from local memory using the utility.

File Format When files are saved to USB they are saved in the following format:
seqX.seq, where X is the memory number 0 ~ 9 (SEQ0 ~ SEQ9). The files are saved to USB:/gw.

When files are recalled from USB, files must be recalled from the same memory number. For example, the file seq0.seq can only be recalled to memory number SEQ0. The files can only be recalled from the USB:/gw directory.

- Steps**
1. Press the *Menu* key. The Menu settings will appear on the display. 
 2. Use the scroll wheel to go to item 12, *Save/Recall Files* and press *Enter*.
 3. Go to the *Type* setting using the scroll wheel and press *Enter*. Select *SEQUENCE* and press *Enter* to confirm.
 4. Go to the *Action* setting and choose the file operation and then press *Enter*.

MEM→USB Saves the selected sequence memory from the local memory to a USB flash drive.

MEM←USB Loads the sequence memory from a USB flash drive to the selected local memory.

DELETE(MEM) Deletes the selected sequence memory from local memory.

- Go to the *Memory No.* setting and select the sequence memory number to perform the operation on. Press *Enter* to confirm.

Memory No. 0 ~ 9 (SEQ0 ~ SEQ9)

Execute File Operation

- Press *Exe[F1]* to perform the file operation.



Exit

- Press *Exit[F4]* to exit from the *Save/Recall Files* settings.



Example



Settings

Running a Sequence

Background When running a sequence, the display changes to the sequence run view.

Run Screen Overview

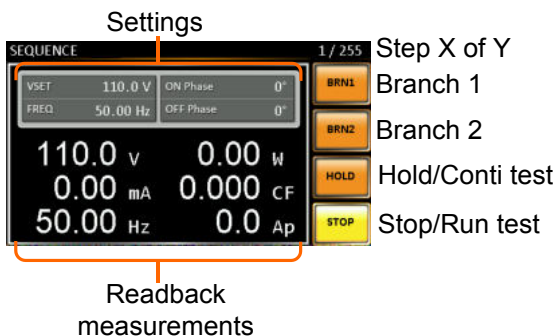

Steps

1. Press *Output*.



2. Press *Run[F4]*. The test will start to run.

The settings of the current step will be shown at the top of the screen and the measurement readout will be shown on the bottom of the screen.

The top-right of the screen will be display the current step number by the total number of steps (current step/total steps).

3. The test will continue to run until the last step has run, or *Stop[F4]* is pressed. When the test has finished/stopped, the screen will return to the original settings screen.
4. If any of the steps have a conditional branch configured, the branch can be manually evoked

during run time by pressing the *BRN1[F1]* (branch 1) soft-key or the *BRN2[F2]* soft-key(branch 2). Alternatively the `:TRIG:SEQ:SEL:EXEC` command can also be used evoke a conditional branch.

Hold Test To pause the test mid-way, press *Hold[F3]*.

Continue Test To continued a paused test, press *Conti[F3]*.

Program Mode Overview

Background The Program mode creates a test program comprised of a number of different memories and steps that can include pass/fail testing. Each memory is made up of 9 steps and each program is made up of 50 memories. A program will run each memory sequentially, which in turn will run each step in the memory sequentially until the program is terminated or a step in the program is programmed to end. Each memory, each step and even each program can also be programmed to loop a user-defined number of times. The diagram below shows the basis of a program.

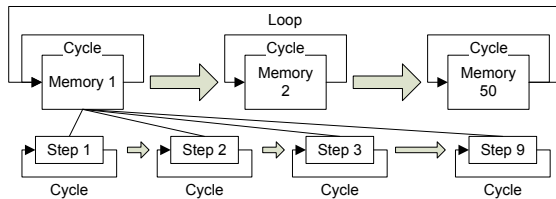

Setting Screen Overview

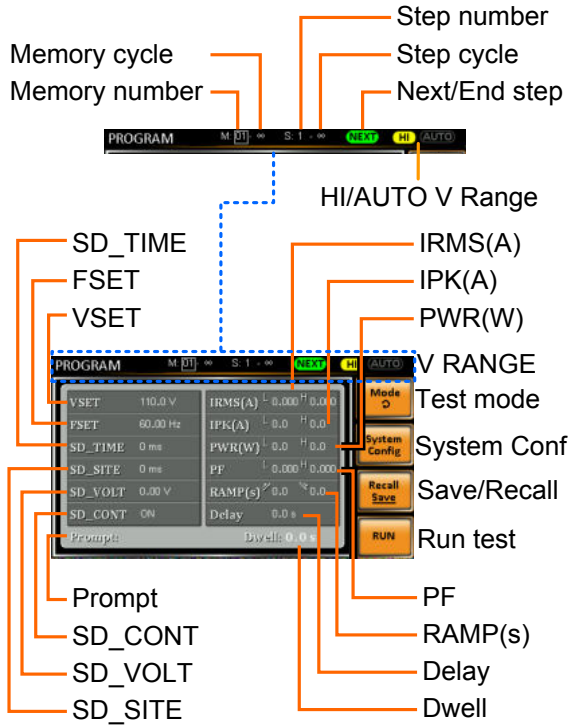

Settings Screen Parameter Overview

The following list describes the parameters on the settings screen.

Memory number	Sets the current memory number.
Memory cycle	Sets the number of cycles for the selected memory number.
Step number	Sets the current step for the current memory number.
Step cycle	Sets the number of cycles for the selected step number.

NEXT/END This setting will configure the action after a step has completed. NEXT will go to the next step/memory. END will end the program at the end of the step.

HI/AUTO V range Sets the voltage range for the program, HI or AUTO.
 When set to AUTO, the unit will automatically set the range to 155VAC, 310VAC or 600VAC (the APS-003 option only).
 When set to HI, the unit range is set to 310VAC or 600VAC if the APS-003 option is installed.

VSET Sets the output voltage for the current step.

FSET Sets the frequency for the current step.

SD_SITE Surge/Dip site position. (T1 time)

SD_TIME Surge/Dip time. (T2 time)

SD_VOLT Surge/Dip voltage. (ACV)

SD_CONT Surge/Dip trigger control. Manual or Auto.

Example

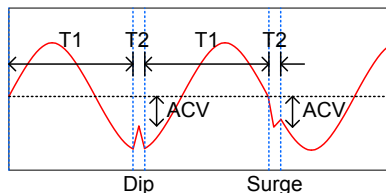

IRMS(A) Sets the IRMS high/low limit for the step.

IPK(A) Sets the peak current high/low limit for the step.

PWR(W)	Sets the power high/low limit for the step.
PF	Sets the power factor high/low limit.
Ramp Up/Down	Sets the ramp up and down times.
Delay	The delay time introduces a delay time before testing pass/fail limits. The delay timing starts as soon as a step has started.
Dwell	The dwell time sets the total execution time of the step.
Prompt	Sets a user-defined text message for the current step. Note: The Enter soft-key must be used to exit out of the text input screen.

On screen keyboard



Enter soft-key

System Configuration Screen Overview

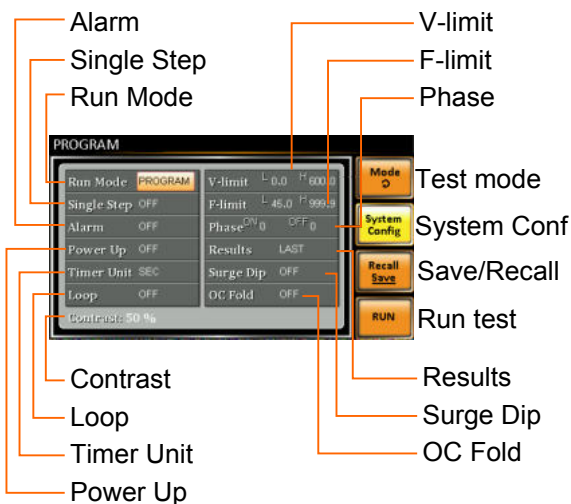

System Configuration Parameters

The System Configuration screen is accessible when the *System Config*[F2] soft-key is pressed.

Run Mode	When set to “MANUAL” mode, only Memory number, VSET, FSET, H-IRMS(A), SD-VOLT, SD-SITE, SD_CONT and SD-TIME will be enabled. When set to “PROGRAM” mode, all the parameters are available.
Single Step	Sets the program to run only one step at a time. After a step is run the program is held until the Output key is pressed, after which the program will go to the next step.
Alarm	Turns the alarm buzzer on/off.
Power Up	When this option is turned on, the current program will be loaded and run after APS-7000 powers up.

Timer Unit	Sets the time units for the Dwell and Delay parameters.
Loop	Determines how many times the program itself will loop (M1 through M50).
V-Limit	Sets the voltage limit.
F-Limit	Sets the frequency limit.
Phase	Sets the ON phase and OFF phase of the step.
Results	Configures how the results are displayed:

ALL: Shows all the step results on the screen.

Example:

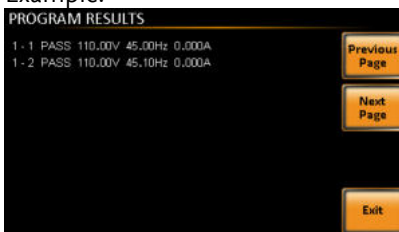

LAST: Only displays the last result.



P/F: If one of the test results is judged a fail, then FAIL is displayed on the screen.

Fail Example:



Pass Example:

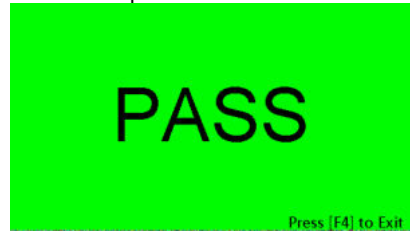

Surge/Dip	Turns the Surge Dip function on/off.
OC Fold	Turns OC Fold on/off.
Contrast	Sets the LCD contrast.

Save a Program to Local Memory

Saving a Sequence Sequence settings can be saved to one of 10 memory slots (PROG0 ~ PROG9).

- Steps
1. Press *Save/Recall*[F3] and then long press a *number key*.
 2. A message will appear when the save is successful.

Save PROG0 ~ PROG9

Recall a Program from Local Memory

Recall a Sequence Sequence settings can be recalled from one of 10 memory slots (PROG0 ~ PROG9).

- Steps
1. Press *Recall*[F2] and then press a *number key*.
 2. A message will appear when the settings are recalled successfully.

Recall PROG0 ~ PROG9

Manage Program Settings

Program settings can be easily saved to or from a USB flash drive using the Save/Recall Files utility in the Menu system. Files can also be deleted from local memory using the utility.

File Format When files are saved to USB they are saved in the following format:
 progX.pro, where X is the memory number 0 ~ 9 (PROG0 ~ PROG9). The files are saved to USB:/gw.

When files are recalled from USB, files must be recalled from the same memory number. For example, the file prog0.pro can only be recalled to memory number PROG0. The files can only be recalled from the USB:/gw directory.

Steps

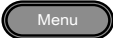
1. Press the *Menu* key. The Menu settings will appear on the display. 
2. Use the scroll wheel to go to item 12, *Save/Recall Files* and press *Enter*.
3. Go to the *Type* setting using the scroll wheel and press *Enter*. Select *SEQUENCE* and press *Enter* to confirm.
4. Go to the *Action* setting and choose the file operation and then press *Enter*.

MEM→USB Saves the selected program memory from the local memory to a USB flash drive.

MEM←USB Loads the program memory from a USB flash drive to the selected local memory.

DELETE(MEM) Deletes the selected program memory from local memory.

- Go to the *Memory No.* setting and select the program memory number to perform the operation on. Press *Enter* to confirm.

Memory No. 0 ~ 9 (PROG0 ~ PROG9)

Execute File Operation

- Press *Exe[F1]* to perform the file operation.



Exit

- Press *Exit[F4]* to exit from the *Save/Recall Files* settings.



Example

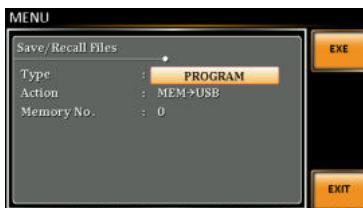

Settings

R

REAR PANEL SIGNAL OUTPUTS

The rear panel has 3 signal output connectors. These connectors are used for external triggering, synchronization and test judgment state. The following chapter will give a brief overview each of these connectors.

J1 Connector Overview	148
Signal Output Overview	149
SYNC Output Overview	150

J1 Connector Overview

Overview

The J1 connector is primarily used for triggering and for monitoring the status of the power supply. Each pin is isolated from the power supply (photo coupled). The Trigger In and Out On/Off input port are pulled high internally to +5V.

The trigger control menu configures the Trigger In and Trigger Out pins. See page 93 for details on the trigger control settings.

Pin Assignment

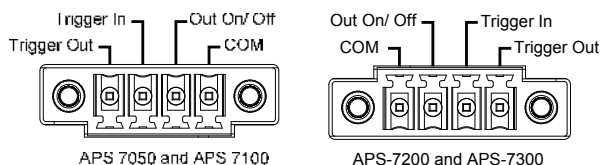

Pin name	Pin	Description
	Trigger Out	Outputs a high signal (+5V) according to the Trigger Out settings in the Trigger Control menu.
	Trigger In	Applying a high level signal to the Trigger In pin performs an action according to the settings in the Trigger Control menu. Actions include, turning the output on, loading a setting or loading one of the preset settings.
	Out On/Off	Applying a high level signal to this port will turn the output on by default.
	COM	Common pin.

Wiring Schematic

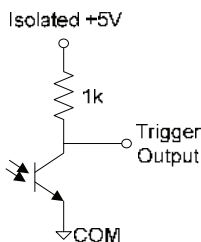

Trigger Input, OUT On/Off +5V

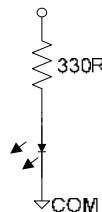

Signal Output Overview

Overview

The Signal Output port is used in the Program Mode. This port is used to remotely monitor the PASS, FAIL and Processing conditions. Each of these conditions are isolated from the APS-7000 with internal relays.

Pin Assignment

Remote relay contact

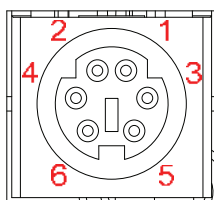

APS-7050
APS-7100

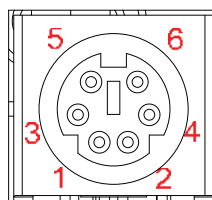

APS-7200
APS-7300

Pin name	Pin number	Description
	1	Pass pin
	2	Pass return pin
	3	Processing pin
	4	Fail pin
	5	Processing return pin
	6	Fail return pin
	Pass: Connect between Pin1 and Pin2	
	Fail: Connect between Pin4 and Pin6	
	Processing: Connect between Pin3 and Pin5	



CAUTION

The internal relays allow for a maximum voltage of 250VAC and maximum current of 3A.

SYNC Output Overview

Overview The SYNC output outputs a +10V signal when the output is turned on.

Pin Assignment

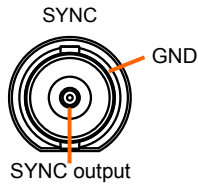

C

COMMUNICATION

INTERFACE

This chapter describes basic configuration of IEEE488.2 based remote control. For a command list, refer to the programming manual, downloadable from GW Instek website, www.gwinstek.com



Note

If the instrument is remotely controlled via the USB/LAN/RS-232/GPIB interface, the panel lock is automatically enabled.

Interface Configuration	152
USB Remote Interface – Optional (APS-7050 and APS-7100 only)	152
RS-232 Remote Interface - Optional.....	153
RS-232/USB Remote Control Function Check.....	156
Using Realterm to Establish a Remote Connection	157
Configure GPIB Interface - Optional.....	160
GPIB Function Check	161
Configure Ethernet Connection.....	165
Web Server Remote Control Function Check.....	167
Socket Server Function Check	168

Interface Configuration

USB Remote Interface – Optional (APS-7050 and APS-7100 only)



USB configuration	PC side connector	Type A, host
	APS-7000 side connector	Rear panel Type B, slave
	Speed	1.1/2.0 (full speed/auto speed)
	USB Class	CDC (communications device class)



Note

The RS-232/USB interface card (APS-002) must first be installed before the USB interface can be used for remote control. Please see page 41 for installation details.

Steps

1. Connect the Type A-Type B USB cable from the PC to the rear panel USB B port. 
2. Press the *Menu* key. The *Menu* setting will appear on the display. 
3. Use the scroll wheel to go to item 6, *Rear USB* and press *Enter*.
4. Go to the *Speed* setting and set the USB speed.

Speed	Full, Auto
-------	------------
5. If the connection is successful *Connection Status* will change from *Offline* to *Online*.

Connection status

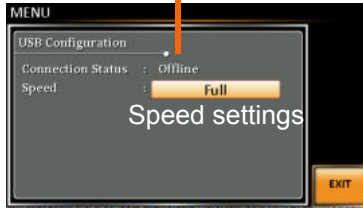

Exit

6. Press *Exit*[F4] to exit from the rear panel USB settings.



RS-232 Remote Interface - Optional

The APS-002 RS-232/USB or APS-007 RS-232 interface card must be installed to remotely control the APS-7000 via the serial port.

RS-232 configuration	Connector	BD-9, male
	Parameters	Baud rate, data bits, parity, stop bits.

Pin Assignment

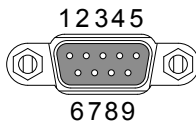

- 2: RxD (Receive data)
 - 3: TxD (Transmit data)
 - 5: GND
 - 4, 6 ~ 9: No connection
-

Pin Connection

Use a Null Modem connection (RS-232C cable) as shown in the diagram below.

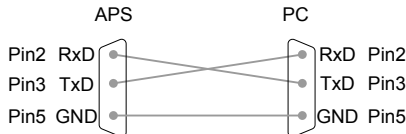





Note

The RS-232/USB (APS-002) or RS-232 (APS-007) must first be installed before the RS-232 interface can be used for remote control. Please see page 41 for installation details.

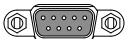
Steps

1. Connect the RS-232C cable from the PC to the rear panel RS-232 port. 
2. Press the *Menu* key. The Menu setting will appear on the display. 
3. Use the scroll wheel to go to item 7, *Serial Port* and press *Enter*.
4. Go to the *Function Active* setting and turn the serial port connection on.

Function Active	ON, OFF
-----------------	---------

5. Set the remaining serial port settings.

Baud rate	1200, 2400, 4800, 9600(default), 19200, 38400, 57600, 115200,
Data bits	7, 8(default)
Parity	None(default), odd, even
Stop bits	1(default),2

Serial port configuration



Exit

6. Press *Exit*[F4] to exit from the serial port settings.



RS-232/USB Remote Control Function Check

Functionality
check

Invoke a terminal application such as Realterm.

For both USB and RS-232, set the COM port, baud rate, stop bit, data bit and parity accordingly. The RS-232 settings are configured on the APS-7000. The UART settings for the USB connection can be seen in the Windows Device Manager.

To check the COM settings in Windows, see the Device Manager. For example, in WinXP go to the Control panel → System → Hardware tab.



Note

If you are not familiar with using a terminal application to send/receive remote commands from the serial port or via a USB connection, please see page 157 for more information.

Run this query command via the terminal after the instrument has been configured for RS-232/USB remote control (page 153, 152).

*IDN?

This should return the Manufacturer, Model number, Serial number, and Software version in the following format.

GWINSTEK,APS-7050, GEXXXXXXX, XX.XX.XXXXXXXX

Manufacturer: GWINSTEK

Model number : APS-7050

Serial number : GEXXXXXXX

Software version : XX.XX.XXXXXXXX



Note

For further details, please see the programming manual, available on the GW Instek web site @ www.gwinstek.com.

Using Realterm to Establish a Remote Connection

Background

Realterm is a terminal program that can be used to communicate with a device attached to the serial port of a PC or via an emulated serial port via USB.

The following instructions apply to version 2.0.0.70. Even though Realterm is used as an example to establish a remote connection, any terminal program can be used that has similar functionality.



Note

Realterm can be downloaded on Sourceforge.net free of charge.

For more information please see <http://realterm.sourceforge.net/>

Operation

1. Download Realterm and install according to the instructions on the Realterm website.
2. Connect the APS-7000 via USB (page 152) or via RS-232 (page 153).
3. If using RS-232, make note of the configured baud rate, stop bits and parity.
4. Go to the Windows device manager and find the COM port number for the connection. For example, go to the Start menu > Control Panel > Device Manager.

Double click the *Ports* icon to reveal the

connected serial port devices and the COM port for the each connected device.

If using USB, the baud rate, stop bit and parity settings can be viewed by right-clicking the connected device and selecting the *Properties* option.

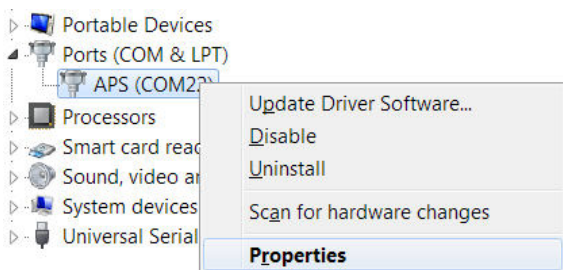

5. Start Realterm on the PC as an administrator.
Click:
Start menu>All Programs>RealTerm>realterm

Tip: to run as an administrator, you can right click the Realterm icon in the Windows Start menu and select the *Run as Administrator* option.

6. After Realterm has started, click on the *Port* tab.

Enter the *Baud*, *Parity*, *Data bits*, *Stop bits* and *Port* number configuration for the connection.

The *Hardware Flow Control*, *Software Flow Control* options can be left at the default settings.

Press *Open* to connect to the APS-7000.

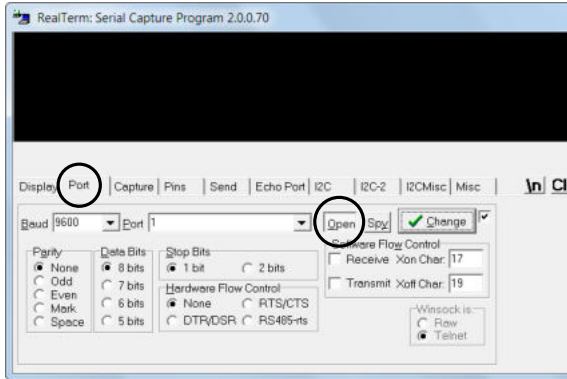

Note

For USB, the baud rate should be fixed to 115,200.

7. Click on the *Send* tab.

In the *EOL* configuration, check on the *+LF* check boxes.

Enter the query:

**idn?*

Click on *Send ASCII*.

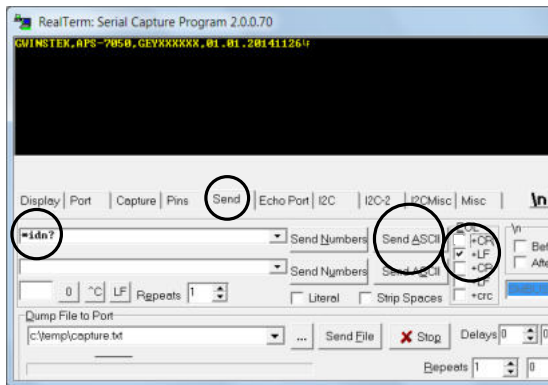

8. The terminal display will return the following:

GWINSTEK,APS-7050, GEXXXXXXX,
XX.XX.XXXXXXXX

(manufacturer, model, serial number, software version)

9. If Realterm fails to connect to the APS-7000, please check all the cables and settings and try again.

Configure GPIB Interface - Optional

To use GPIB, the optional APS-001 GPIB interface card must first be installed.



Note

The GPIB interface card (APS-001) must first be installed before the GPIB interface can be used for remote control. Please see page 41 for installation details.

GPIB
Configuration

1. Connect a GPIB cable from the PC to the GPIB on the interface card.

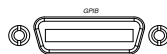

2. Press the *Menu* key. The Menu setting will appear on the display.

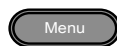

3. Use the scroll wheel to go to item 8, *GPIB* and press *Enter*.
4. If the GPIB card is installed successfully, the *Card Status* will show *Plugged in*.
5. Go to the *Function Active* setting and turn the GPIB port on.

Function Active ON, OFF

6. Set the GPIB address.

GPIB Address 0 ~ 30

GPIB port configuration

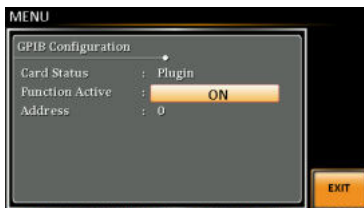

Exit

7. Press *Exit*[F4] to exit from the serial port settings.



GPIB constraints

- Maximum 15 devices altogether, 20m cable length, 2m between each device
- Unique address assigned to each device
- At least 2/3 of the devices turned On
- No loop or parallel connection

GPIB Function Check

Functionality check

Please use the National Instruments Measurement & Automation Controller software to confirm GPIB/LAN functionality.

See the National Instrument website, <http://www.ni.com> for details.



Note

For further details, please see the programming manual, available on the GW Instek web site @ www.gwinstek.com.

Operation

1. Start the NI Measurement and Automation Explorer (MAX) program. Using Windows, press:



Start>All Programs>NI MAX

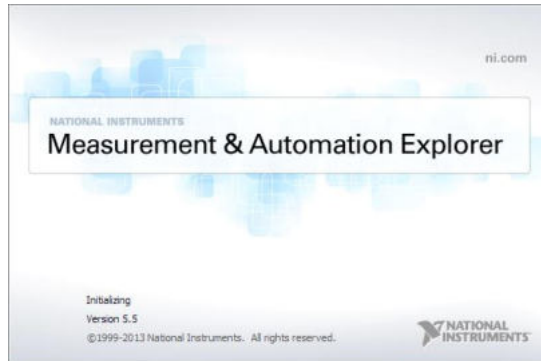

2. From the Configuration panel access;
My System>Devices and Interfaces>GPIB0

3. Press the Scan for Instruments button.
4. In the *Connected Instruments* panel the APS-7000 should be detected as *Instrument 0* with the address the same as that configured on the APS-7000.
5. Double click the *Instrument 0* icon.

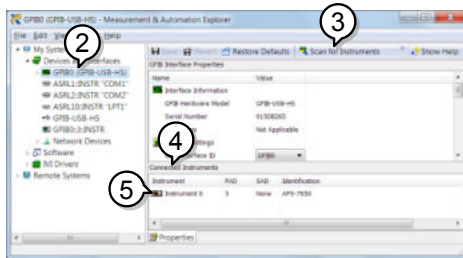

6. Click on Visa Properties.
7. Click on Open Visa Test Panel.

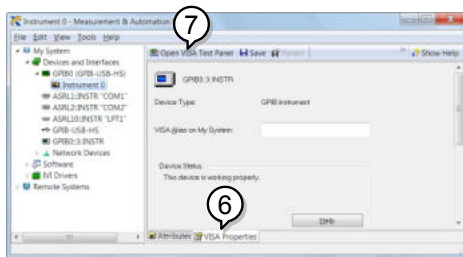

8. Click on the *Input/Output* icon.
9. Under the Basic I/O tab, ensure **IDN?* is written in the *Select or Enter Command* text box.
10. Click on the *Query* button to send the **IDN?* query to the instrument.

11. The instrument identification string will be returned to the buffer area:

GWINSTEK,APS-7050, GEXXXXXXXXX,
XX.XX.XXXXXXXXXX

(manufacturer, model, serial number, software version)



12. The function check is complete.



Configure Ethernet Connection

The Ethernet interface can be configured for a number of different applications. Ethernet can be configured for basic remote control or monitoring using a web server or it can be configured as a socket server.

The APS-7000 supports both DHCP connections so the instrument can be automatically connected to an existing network or alternatively, network settings can be manually configured.

Ethernet Parameters	MAC Address (display only)	DHCP
	IP Address	Subnet Mask
	Gateway	DNS Address
	DNS Server	Socket port fixed at 2268

Ethernet Configuration

1. Connect a LAN cable from the PC to the Ethernet port on the rear panel. 
2. Press the *Menu* key. The Menu setting will appear on the display. 
3. Use the scroll wheel to go to item 5, *LAN* and press *Enter*.
4. If the LAN cable is installed correctly a connection is active, the *Connection Status* will show *Online*.
5. To automatically have the network assign an IP address, set DHCP to ON. Otherwise set DHCP to OFF to manually set the Ethernet settings.

DHCP	ON, OFF
------	---------

6. If DHCP was set to OFF, configure the remaining LAN parameters.

IP Address

Subnet Mask

Gateway

DNS Server

LAN configuration

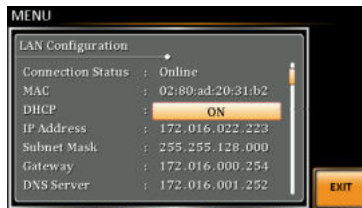

Exit

7. Press *Exit*[F4] to exit from the LAN settings.



Web Server Remote Control Function Check

Functionality
check

Enter the IP address of the power supply (for example: http:// XXX.XXX.XXX.XXX) in a web browser after the instrument has been configured for LAN(page 165).

The web interface allows you to:

- View the system and information and the network configuration.
- View the analog control pinout.
- View the dimensions of the unit.
- View the operating area

Example:

The screenshot displays the GW INSTEK web interface. At the top, the logo 'GW INSTEK' is followed by the tagline 'Made to Measure'. Navigation links include 'Visit Our Site', 'Support', and 'Contact Us'. The main content area is divided into several sections: 'Welcome Page', 'Network Configuration', 'Analog Control', 'Figure of Dimensions', and 'Operating Area'. The 'Network Configuration' section is highlighted and contains the following fields: IP Address (172.16.5.125), Subnet Mask (255.255.128.0), Gateway (172.16.0.254), DNS (172.16.1.252), and DHCP State (radio buttons for ON and OFF, with OFF selected). The 'Figure of Dimensions' section has a Password field. A 'Submit' button is located at the bottom right of the form.

Socket Server Function Check

Background To test the socket server functionality, National Instruments Measurement and Automation Explorer can be used. This program is available on the NI website, www.ni.com, via a search for the VISA Run-time Engine page, or “downloads” at the following URL, <http://www.ni.com/visa/>

Requirements Operating System: Windows XP, 7, 8, 8.1

Functionality check

1. Start the NI Measurement and Automation Explorer (MAX) program. Using Windows, press:

Start>All Programs>NI MAX

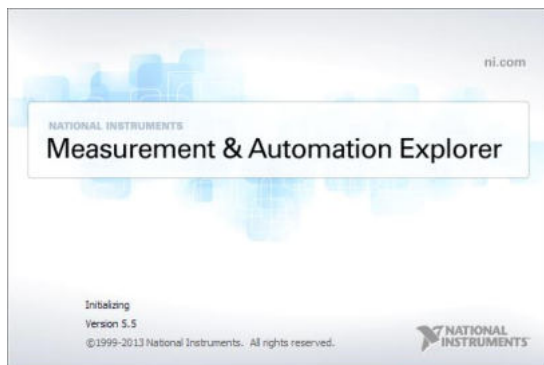

2. From the Configuration panel access;
My System>Devices and Interfaces>Network Devices
3. Press Add New Network Device>Visa TCP/IP Resource...

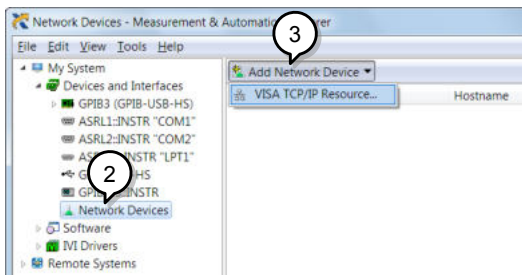

4. Select *Manual Entry of Raw Socket* from the popup window.

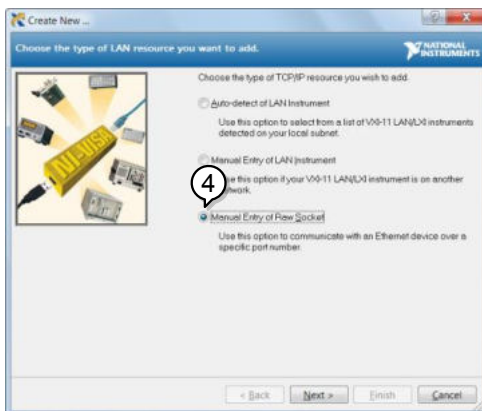

5. Enter the IP address and the port number of the APS-7000. The port number is fixed at 2268.
6. Double click the Validate button and press *Next*.

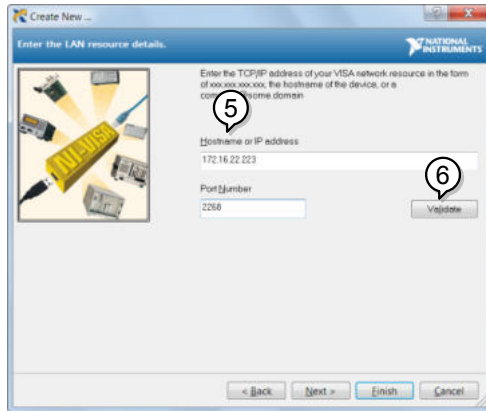

7. Next configure the Alias (name) of the APS-7000 connection. In this example the Alias is: APS
8. Click finish.

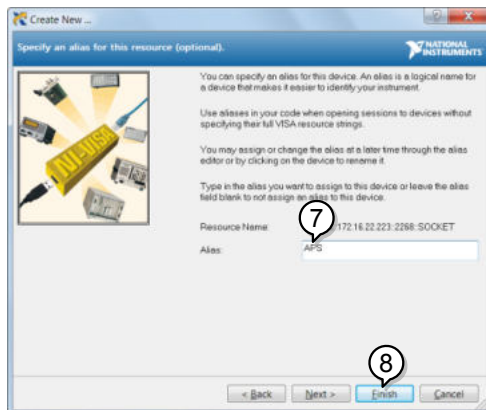

9. The IP address of the power supply will now appear under Network Devices in the configuration panel. Select this icon now.
10. Press Open VISA Test Panel.

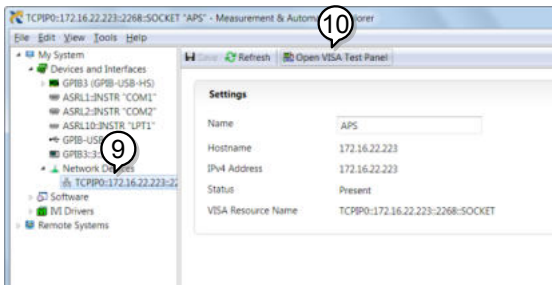

11. Click the *Configuration* icon. Under the *IO Settings* tab check *Enable Termination Character*. The termination character should be set as *Line Feed - \n*.

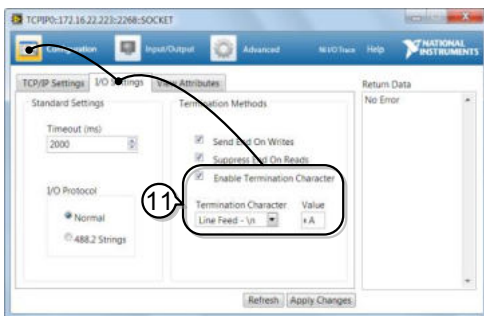

12. Click the *Input/Output* icon. Under the *Basic I/O* tab, make sure **IDN? \n* is entered in the *Select or Enter Command* drop box.
13. Click *Query*.

The APS-7000 will return the machine identification string into the buffer area:
**GWINSTEK,APS-7050,GEXXXXXXX,
 XX.XX.XXXXXXXX**

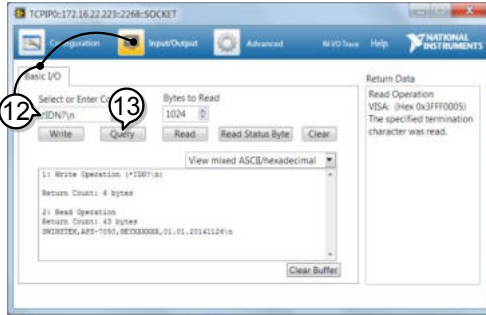

 Note

For further details, please see the programming manual, available on the GW Instek web site @ www.gwinstek.com.

F AQ

- The accuracy does not match the specification.
- The display shows “fuse broken” message.
- The display shows “output shorted” message.
- The display shows “waiting for 10secs” message.
- The display shows “OCP” message.
- The display shows “Remote Sense Error” message.

The accuracy does not match the specification.

Make sure the device is powered On for at least 30 minutes, within +18°C~+28°C. This is necessary to stabilize the unit to match the specification.

The display shows “fuse broken” message.

The internal protection fuse is open. Contact your local dealer or GW Instek.

The display shows “output shorted” message.

Make sure the DUT is correctly connected to the APS-7000 output terminals and that no shortcut exist. A DUT malfunction may also be the cause.

The display shows “waiting for 10secs” message.

A protection function is likely in force, check the DUT settings.

The display shows “OCP” message.

OCP message be occurred that is mean over the specification of APS-7000 series.

Even set Irms is equal to 0.

Purchasing more higher power AC Source, please.

The display shows “Remote Sense Error” message.

Remote Sense Error message be occurred that is mean remote sense connection has mistake. Double check connection, please.

For more information, contact your local dealer or GWInstek at www.gwinstek.com / marketing@goodwill.com.tw.

APPENDIX

Firmware Update

Background The APS-7000 firmware can be upgraded using the USB A port on the front panel. See your local distributor or the GW Instek website for the latest firmware information.



- Ensure the DUT is not connected.
 - Ensure the output is off.
-

Steps 1. Insert a USB Flash Drive into the USB port on front panel of the APS-7000.

- The USB drive should include the **gw.sbt** file in a directory name “gw”(USB\gw:).

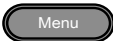
Steps 2. Press the *Menu* key. The Menu setting will appear on the display. 

3. Use the scroll wheel to go to item 11, *Special Function* and press *Enter*.

4. Key in the password when prompted and then press *Enter*.

- The password is “5004”.

5. Go to Item 1, *Update Main Program* and press *Enter*.

Exit

6. Wait for the unit to update. Upon completion the unit will automatically reset.
-

Example

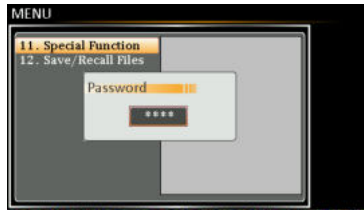

Password setting screen

APS-7000 Default Settings

The following default settings are the factory configuration settings for the power supply.

For details on how to return to the factory default settings, see page 54.

Continuous Mode	APS-7050	APS-7100	APS-7200	APS-7300
Range			155V	
ACV			0.00V	
FREQ			60.00Hz	
IRMS	4.20A	8.40A	16.80A	25.20A
ON PHS			0°	
OFF PHS			0°	
V limit			155.0Vrms	
F Limit			500.0Hz	
Ipeak Limit	16.80A	33.60A	67.20A	100.8A

Simulation Mode	APS-7050	APS-7100	APS-7200	APS-7300
Step			Initial	
Repeat			1	
Time			0.10s	
ON Phs			ON, 0	
Vset			0.00	
OFF Phs			ON, 0	
Fset			50.00	
Trig Out			LO	
Range			HI	

Sequence Mode	APS-7050	APS-7100	APS-7200	APS-7300
Step			0	
Time			0.10s	
Jump To			ON, 1	
Jump Cnt			1	
Branch1			OFF	
Branch2			OFF	
Term			CONTI	
Trig Out			LO	

ON Phs	OFF
OFF Phs	OFF
Vset	0.00, CT
Fset	50.00

Program Mode	APS-7050	APS-7100	APS-7200	APS-7300
Not applicable				

Configuration Menu	APS-7050	APS-7100	APS-7200	APS-7300
Surge/Dip Control			OFF	
Ramp Control			OFF	
T ipeak, hold(msec)			1ms	
Power ON Output			OFF	
Buzzer			ON	
SCPI Emulation			GW	
Program Timer			SEC (seconds)	
Remote Sense	N/A	N/A	OFF	OFF
LAN, Rear USB, Serial Port, GPIB			N/A	
LCD Contrast			50%	
LCD Brightness			50%	
LCD Saturation			50%	

APS-7000 Specifications

The specifications apply when the APS-7000 is powered on for at least 30 minutes. Note that the high frequency and high voltage options are listed as separate specifications.

Standard APS-7000

Model	APS-7050	APS-7100	APS-7200	APS-7300
AC Input				
Phase	Single Phase			
Voltage	115/230 Vac \pm 15%		230 Vac \pm 15%	
Frequency	50/60 Hz			
Max. Current	16A/8A	32A/16A	32A	50A
Power Consumption	1.8 kVA or less	3.6 kVA or less	7.2 kVA or less	10.8 kVA or less
Power Factor	0.7 Typ.			
AC Output				
Power Rating	500 VA	1000 VA	2000 VA	3000 VA
Output Voltage	0 ~ 155Vrms / 0 ~ 310.0 Vrms			
Output Frequency	45.00 ~ 500.0 Hz			
Maximum Current (r.m.s) ^{*1}				
0 ~ 155 Vrms	4.2 A	8.4 A	16.8 A	25.2 A
0 ~ 310 Vrms	2.1 A	4.2 A	8.4 A	12.6 A
Maximum Current (peak)				
0 ~ 155 Vrms	16.8 A	33.6 A	67.2 A	100.8 A
0 ~ 310 Vrms	8.4 A	16.8 A	33.6 A	50.4 A
Phase	Single Phase, Two Wire (1P2W)			
Total harmonic distortion (THD) ^{*2}	\leq 0.5% at 45 ~ 500Hz (Resistive Load)			
Crest factor	\geq 4			
Line regulation	0.1% (% of full scale)			
Load regulation	0.5% (% of full scale)			
Response time	< 100 μ S			
Reverse current	30% of Maximum Output RMS Current (Continue) 100% of Maximum Output RMS Current (Within 3 minutes)			

Model	APS-7050	APS-7100	APS-7200	APS-7300
Setting				
Voltage				
Range	0 ~ 155 Vrms, 0 ~ 310 Vrms, Auto			
Resolution	0.01 V at 0.00 ~ 99.99 Vrms 0.1 V at 100.0 ~ 310.0 Vrms			
Accuracy	± (0.5% of setting + 2 counts)			
Frequency				
Range	45 ~ 500 Hz			
Resolution	0.01 Hz at 45.00 ~ 99.99 Hz 0.1 Hz at 100.0 ~ 500.0 Hz			
Accuracy	± 0.02% of Setting			
Power on/off phase angle				
Range	0 ~ 359°			
Resolution	1°			
Accuracy	± 1° (only 45 ~ 65 Hz)			
Measurement *3				
Voltage (r.m.s)				
Range	0.20 ~ 38.75 Vrms 38.76 ~ 77.50 Vrms 77.51 ~ 155.0 Vrms 155.1 ~ 310.0 Vrms			
Resolution	0.01 V at 0.00 ~ 99.99 Vrms 0.1 V at 100.0 ~ 310.0 Vrms			
Accuracy *4	± (0.5% of reading + 2 counts)			
Frequency				
Range	45 ~ 500 Hz			
Resolution	0.01 Hz at 45.00 ~ 99.99 Hz 0.1 Hz at 100.0 ~ 500.0 Hz			
Accuracy *5	± 0.1 Hz			
Current (r.m.s)				
Range	2.00 ~ 70.00 mA 60.0 ~ 350.0 mA 0.300 ~ 3.500 A 3.00 ~ 17.50 A		0.200 ~ 3.500 A 3.00 ~ 35.00 A	
Resolution	0.01 mA 0.1 mA 0.001 A 0.01 A		0.001 A 0.01 A	

Model	APS-7050	APS-7100	APS-7200	APS-7300
Accuracy	± (0.6% of reading+5 counts), 2.00 ~ 350.0 mA		± (0.5% of reading+5 counts), 0.200 ~ 3.500 A	
	± (0.5% of reading+5 counts), 0.350 ~ 3.500 A		± (0.5% of reading+3 counts), 3.00 ~ 35.00 A	
	± (0.5% of reading+3 counts), 3.500 ~ 17.50 A			
Current (peak)				
Range	0.0 ~ 70.0 A		0.0 ~ 140.0 A	
Resolution	0.1 A		0.1 A	
Accuracy	± (1% of reading + 1 count)		± (1% of reading + 1 count)	
Power (W)				
Resolution	0.01 W		0.1 W	
	0.1 W		1 W	
	1 W			
Accuracy	± (0.6% of reading+5 counts), 0.20 ~ 99.99 W		± (0.6% of reading+5 counts), 0.2 ~ 999.9 W	
	± (0.6% of reading+5 counts), 100.0 ~ 999.9 W		± (0.6% of reading+2 counts), 1000 ~ 9999 W	
	± (0.6% of reading+2 counts), 1000 ~ 9999 W			
Apparent Power (VA)				
Resolution	0.01 VA		0.1 VA	
	0.1 VA		1 VA	
	1 VA			
Accuracy	± (1% of reading + 7 counts), 0.20 ~ 99.99 VA		± (1% of reading + 7 counts), 0.2 ~ 999.9 VA	
	± (1% of reading + 7 counts), 100.0 ~ 999.9 VA		± (1% of reading + 5 counts), 1000 ~ 9999 VA	
	± (1% of reading + 5 counts), 1000 ~ 9999 VA			
Power Factor				
Resolution	0.001			
Accuracy	±2% reading + 2 counts			

Model	APS-7050	APS-7100	APS-7200	APS-7300
General				
Remote output signal	Pass, Fail, Test-in Process, Trigger in, Trigger out, OUT ON/OFF			
Trigger Out	Maximum low level output = 0.8V Minimum high level output = 2V Maximum source current = 8mA.			
Trigger In	Maximum low level input voltage = 0.8V Minimum high level input voltage = 2.0V Maximum sink current = 8mA.			
Sync output signal	Output Signal 10 V, BNC Type			
Number of Preset	10 (0~9 numeric keys)			
Protection	OCP, OPP, OTP and Alarm			
Environmental Conditions				
Operating temperature range	0 ~ +40 °C			
Storage temperature range	-10 ~ +70 °C			
Operating humidity range	20 ~ 80% RH (no condensation)			
Storage humidity range	80% RH or less (no condensation)			
LCD Display	4.3 inch, 480 (RGB) x 272			
Dimensions (mm)				
W	430	430	430	430
H	88	88	312	400
D	400	560	650	650
Weight	24Kg	38Kg	90Kg	128Kg
Withstand voltage				
Between input and chassis:	No abnormalities at 1500 Vac for 1 minute			
Between input and output:	No abnormalities at 3000 Vac for 1 minute			
Between output and chassis:	No abnormalities at 500 Vac for 1 minute			
Insulation resistance				
Between input and chassis:				
Between input and output:	500 Vdc, 1000MΩ or more Ω			
Between output and chassis:				
Sequence/Simulation Function				
Number of Memories	10 (0~9 numeric keys)			
Number of Steps	255max. (for 1 sequence)			
Step Time Setting Range ^{**9}	0.01 ~ 999.99 S			
Operation within Step	Constant, Keep, Linear Sweep			
Parameters	Output Range, Frequency, Waveform (sine wave only), On Phase, Off Phase, Term Jump Count (0 ~255), Jump-to, Branch 1, Branch 2, Trigger Output			

Sequence Control	Start, Stop, Hold, Continue, Branch 1, Branch 2	
Interface		
Standard	USB Host, LAN	USB Host, USB-CDC, LAN
Optional	GPIB (APS-001) RS232/ USB CDC(APS- 002)	GPIB (APS-001) RS232 (APS-007)

APS-003 Option

Output Voltage 0 ~ 600 Vrms				
Model	APS-7050	APS-7100	APS-7200	APS-7300
Output				
Power Rating	500VA	1000VA	2000VA	3000VA
Maximum current (r.m.s) ^{*6} 0 ~ 600Vrms	1.05 A	2.1 A	4.2 A	6.3 A
Maximum current (peak) 0 ~ 600Vrms	4.2 A	8.4 A	16.8 A	25.2 A
Setting				
Voltage				
Range	0 ~ 155 Vrms, 0 ~ 310 Vrms, 0 ~ 600 Vrms, Auto			
Resolution	0.01V at 0.00 ~ 99.99 Vrms 0.1V at 100.0 ~ 600.0 Vrms			
Accuracy ^{*7}	± (0.5% of setting + 2 counts)			
Measurement^{*3}				
Voltage (r.m.s)				
Range	0.2 ~ 600.0 Vrms			
Resolution	0.01V at 0.00 ~ 99.99 Vrms 0.1V at 100.0 ~ 600.0 Vrms			
Accuracy	± (0.5% of reading + 2 counts)			

APS-004 Option

Output Frequency 45 ~ 1000 Hz				
Model	APS-7050	APS-7100	APS-7200	APS-7300
Setting				
Frequency				
Range	45.00 ~ 1000 Hz			
Resolution	0.01 Hz at 45.00 ~ 99.99 Hz 0.1 Hz at 100.0 ~ 999.9 Hz 1 Hz at 1000 Hz			
Accuracy	± 0.02% of Setting			
Measurement^{*3}				
Frequency				
Range	45.00 ~ 1000 Hz			
Resolution	0.01Hz at 45.00 ~ 99.99Hz 0.1Hz at 100.0 ~ 999.9Hz 1 Hz at 1000 Hz			
Accuracy	0.1/1 Hz			

AC Output

Total harmonic distortion (THD) ^{*8}	≤0.5% at 45 ~ 1000Hz (Resistive Load)
---	---------------------------------------

Product specifications are subject to change without notice.

The Specifications are not suit for ARB mode.

*1 Maximum output current at working voltage 120Vrms, 240Vrms

*2 45 Hz to 500 Hz, 10% or higher of the rated output voltage, the maximum current or lower.

*3 All of measurement accuracy is at 23±5°C.

*4 In the case of 15 V to 155 V / 30 V to 310 V, sine wave, no load.

*5 For an output voltage of 75 V to 155 V / 150 V to 310 V, sine wave, no load

*6 Maximum output current at working voltage 480Vrms.

*7 In the case of 60 V to 600 V, sine wave, no load.

*8 45 Hz to 1000 Hz, 10% or higher of the rated output voltage, the maximum current or lower.

*9 Step Time does not guarantee specification.

APS-7000 Dimensions

APS-7050

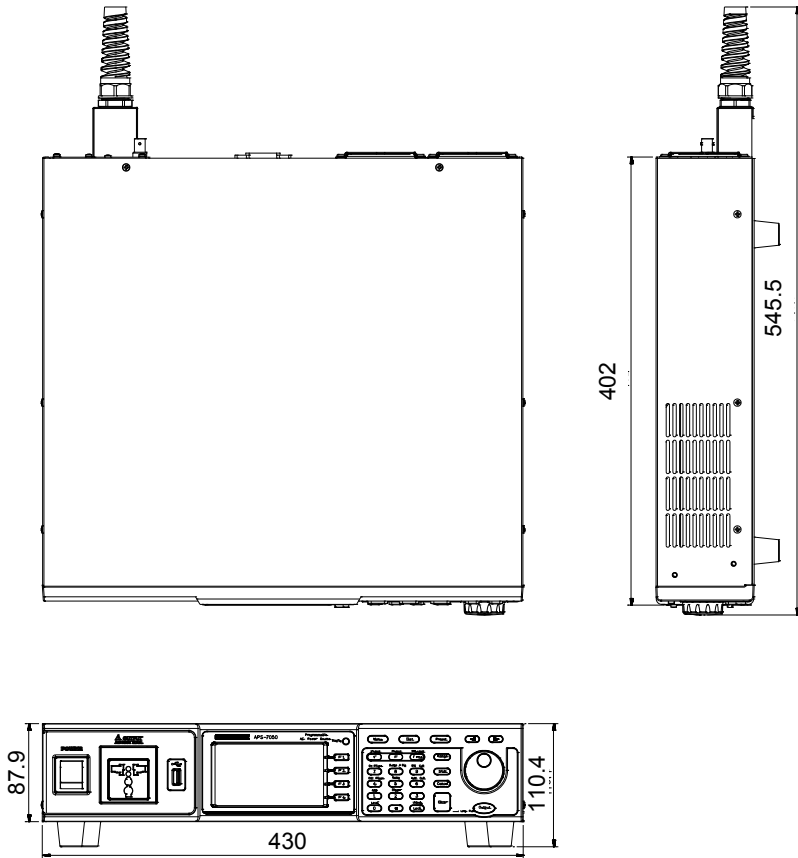

Scale = mm

APS-7100

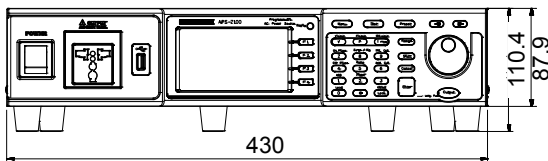
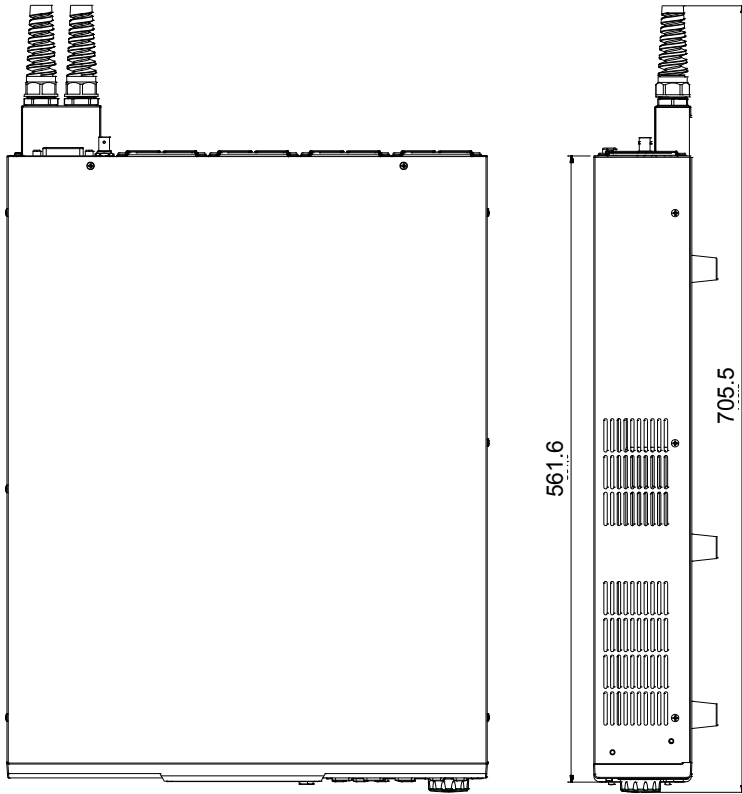

Scale = mm

APS-7200

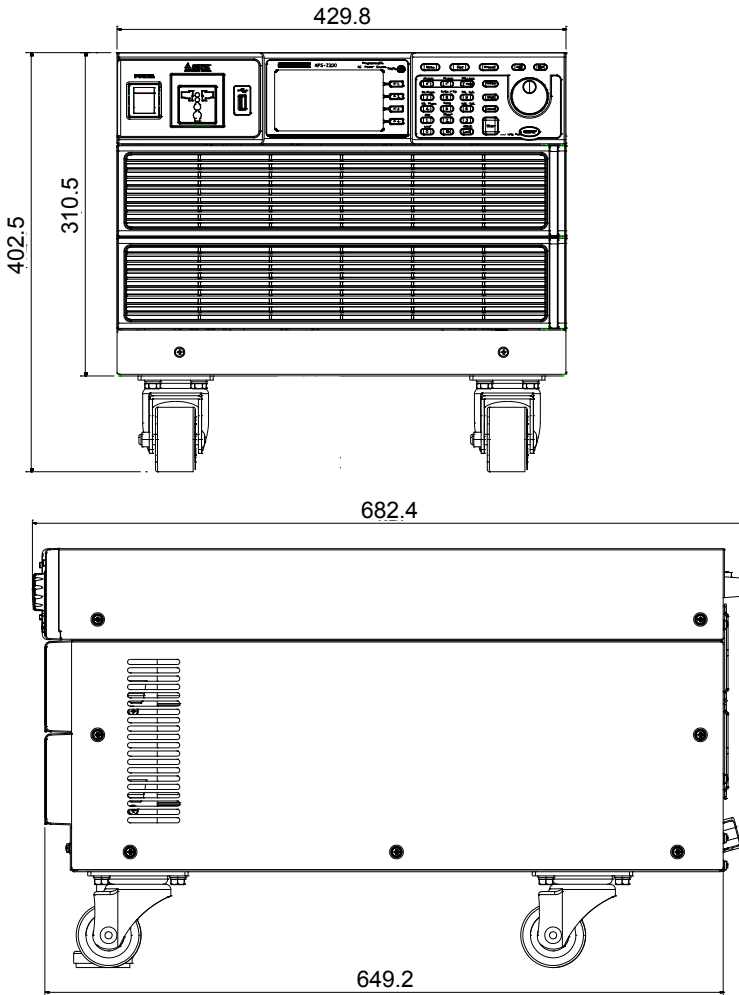

Scale = mm

APS-7300

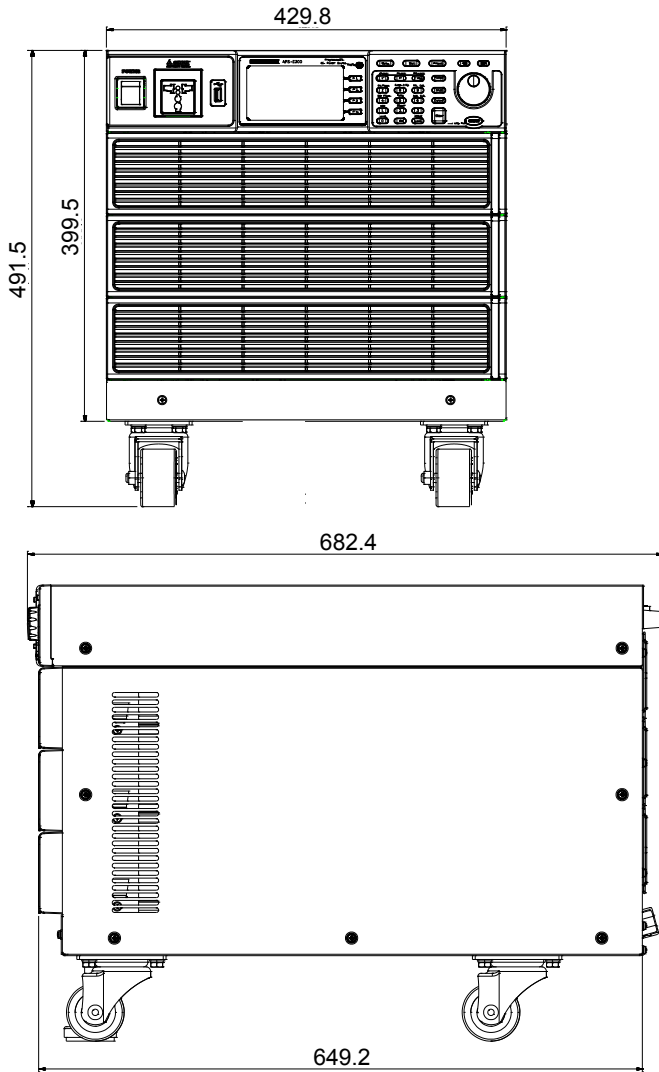

Scale = mm

Certificate Of Compliance (Only for APS-7050 and APS-7100)

We

GOOD WILL INSTRUMENT CO., LTD.

declare that the CE marking mentioned product

satisfies all the technical relations application to the product within the scope of council:

Directive: EMC; LVD; WEEE; RoHS

The product is in conformity with the following standards or other normative documents:

© EMC	
EN 61326-1	Electrical equipment for measurement, control and laboratory use -- EMC requirements
Conducted & Radiated Emission EN 55011 / EN 55032	Electrical Fast Transients EN 61000-4-4
Current Harmonics EN 61000-3-2 / EN 61000-3-12	Surge Immunity EN 61000-4-5
Voltage Fluctuations EN 61000-3-3 / EN 61000-3-11	Conducted Susceptibility EN 61000-4-6
Electrostatic Discharge EN 61000-4-2	Power Frequency Magnetic Field EN 61000-4-8
Radiated Immunity EN 61000-4-3	Voltage Dip/ Interruption EN 61000-4-11 / EN 61000-4-34
© Safety	
EN 61010-1 :	Safety requirements for electrical equipment for measurement, control, and laboratory use - Part 1: General requirements

GOODWILL INSTRUMENT CO., LTD.

No. 7-1, Jhongsing Road, Tucheng District, New Taipei City 236, Taiwan

Tel: [+886-2-2268-0389](tel:+886-2-2268-0389)

Fax: [+886-2-2268-0639](tel:+886-2-2268-0639)

Web: <http://www.gwinstek.com>

Email: marketing@goodwill.com.tw

GOODWILL INSTRUMENT (SUZHOU) CO., LTD.

No. 521, Zhujiang Road, Snd, Suzhou Jiangsu 215011, China

Tel: [+86-512-6661-7177](tel:+86-512-6661-7177)

Fax: [+86-512-6661-7277](tel:+86-512-6661-7277)

Web: <http://www.instek.com.cn>

Email: marketing@instek.com.cn

GOODWILL INSTRUMENT EURO B.V.

De Run 5427A, 5504DG Veldhoven, The Netherlands

Tel: [+31-\(0\)40-2557790](tel:+31-(0)40-2557790)

Fax: [+31-\(0\)40-2541194](tel:+31-(0)40-2541194)

Email: sales@gw-instek.eu

INDEX

Accessories	12	Ethernet	
Advanced settings		interface.....	165
Buzzer	91	Filter installation	31
miscellaneous.....	88	Firmware update.....	175
Power output	90	Frequency limit	64
Program timer unit.....	93	Frequency output.....	65
ramp	85	Front panel diagram	14
SCPI emulation	92	Ground	
surge/dip	82	symbol.....	4
T Ipeak	88	I rms.....	70
trigger.....	95	Ipk measurement range	68
Alarm clear	74	Ipk range	68
Analog control		Ipk-Limit	66
overview	147	Irms Delay time	71
ARB.....	104	J1 connector	
Overview	105	pin assignment	148
Waveform.....	108	LCD configuration	56
Buzzer	91	Line voltage	
Caution symbol.....	4	1000VA models	28
Cleaning the instrument	6	List of features.....	11
clear alarm	74	Load preset to local memory ..	101
Conventions	50	Load preset to USB	102
Current RMS	70	Load program to USB.....	145
Declaration of conformity	190	Load sequence to USB	133
Default settings	177	Load simulation to USB	120
reset.....	54	Marketing	
Delay time.....	67	contact	174
Delete program memory	145	Model differences	9
Delete sequence memory	133	Module installation.....	41
Delete simulation memory	120	software.....	43
Display mode		OC fold	72
operation.....	75	On/off phase	73
Disposal instructions.....	6	Output terminals.....	34
EN61010		Panel lock	77
measurement category.....	5	Peak current limit.....	66
pollution degree.....	6	Power on output	90
Environment		Power on/off	
safety instruction	6		

safety instruction.....	5	Surge/dip control	82
Power up	33	SYNC output	
Preset settings	100	pin assignment	150
Program timer unit.....	93	System version	
Rack mount		view	55
description	48	T Ipeak.....	88
Ramp control.....	85	Test	
Remote control.....	151	Overview	111
Ethernet	165	Program	
GPIB	160	Overview	137
LAN	165	Recall.....	144
RS232	153	Save	144
USB	152	Sequence	
Remote control function check		Overview	124
GPIB	161	Recall.....	132
Realterm	157	Run.....	135
RS-232.....	156	Save	132
USB	156	Settings	128
Save preset to local memory ..	100	Simulation	
Save preset to USB.....	102	Overview	112
Save program to USB	145	Recall.....	119
Save sequence to USB	133	Run.....	122
Save simulation to USB.....	120	Save	119
SCPI emulation	92	Settings	116
Serial number		Trigger control	95
view	55	Trigger in	96
Service operation		UK power cord.....	7
about disassembly.....	5	Updating the firmware	175
contact.....	174	USB driver installation.....	57
Signal output		Voltage limit	61
pin assignment	149	Voltage output level	62
Socket server function check..	168	Voltage range	60
Specifications	179	Warning symbol	4
Start/stop phase	73	Web server function check	167
		Wire gauge chart.....	39