

Multi-phase Programmable AC/DC Power Source

ASR-6000 Series

PROGRAMMING MANUAL

Rev. C



ISO-9001 CERTIFIED MANUFACTURER

GW INSTEK

This manual contains proprietary information, which is protected by copyright. All rights are reserved. No part of this manual may be photocopied, reproduced or translated to another language without prior written consent of Good Will company.

The information in this manual was correct at the time of printing. However, Good Will continues to improve products and reserves the rights to change specification, equipment, and maintenance procedures at any time without notice.

Good Will Instrument Co., Ltd.
No. 7-1, Jhongsing Rd., Tucheng Dist., New Taipei City 236, Taiwan.

Table of Contents

SAFETY INSTRUCTIONS	4
GETTING STARTED.....	8
ASR-6000 Series Overview	9
Appearance.....	13
REMOTE CONTROL.....	21
Interface Configuration.....	23
Command Syntax.....	44
Command List	48
Status Register Overview	169
Error List	185
APPENDIX.....	194
Factory Default Settings.....	194
INDEX	205

S SAFETY INSTRUCTIONS

This chapter contains important safety instructions that you must follow during operation and storage. Read the following before any operation to ensure your safety and to keep the instrument in the best possible condition.

Safety Symbols

These safety symbols may appear in this manual or on the instrument.



WARNING

Warning: Identifies conditions or practices that could result in injury or loss of life.



CAUTION

Caution: Identifies conditions or practices that could result in damage to the ASR-6000 or to other properties.



DANGER High Voltage



Attention Refer to the Manual



Protective Conductor Terminal



Earth (ground) Terminal



Do not dispose electronic equipment as unsorted municipal waste. Please use a separate collection facility or contact the supplier from which this instrument was purchased.

Safety Guidelines

General Guideline



CAUTION

- Do not place any heavy object on the ASR-6000.
- Avoid severe impact or rough handling that leads to damaging the ASR-6000.
- Do not discharge static electricity to the ASR-6000.
- Use only mating connectors, not bare wires, for the terminals.
- Do not block the cooling fan opening.
- Do not disassemble the ASR-6000 unless you are qualified.
- If the equipment is used in a manner not specified by the manufacturer, the protection provided by the equipment may be impaired.
- Due to the fact that ASR-6000 unit weights greater than 18kg, please resort to the standard kit GRA-451-E for transport or remove the unit by at least two persons in case of danger occurred.

Power Supply



WARNING

- AC Input voltage range:
200 Vac to 240 Vac $\pm 10\%$
phase voltage (Delta: L-L, Y: L-N)
 - Frequency: 47 ~ 63 Hz
 - To avoid electrical shock connect the protective grounding conductor of the AC power cord to an earth ground.
 - The power switch that is included in the instrument is not considered a disconnecting device.
 - The permanently connected power input is used as the disconnecting device and shall remain readily operable.
 - a. A switch or circuit-breaker must be included in the installation
 - b. It must be suitably located and easily reached
 - c. It must be marked as the disconnecting device for the equipment.
 - d. It shall be located near the equipment
 - Do not position the equipment so that it is difficult to operate the disconnecting device.
 - Ask for professional technician for installation.
 - It requires 200Vac input condition and the maximum input current [30A (ASR-6450), 40A (ASR-6600)], which conforms to cord diameter by local regulations.
 - Breaker, of which the specification is required to larger than 30A (ASR-6450), 40A (ASR-6600) individually, should be in the near proximity of unit.
-

- Cleaning the ASR-6000
- Disconnect the circuit-breaker or permanently connected power input before cleaning.
 - Use a soft cloth dampened in a solution of mild detergent and water. Do not spray any liquid.
 - Do not use chemicals containing harsh material such as benzene, toluene, xylene, and acetone.

- Operation Environment
- Location: Indoor, no direct sunlight, dust free, almost non-conductive pollution (Note below)
 - Relative Humidity: 20%~ 80%, no condensation
 - Altitude: < 2000m
 - Temperature: 0°C to 40°C
- (Pollution Degree) EN 61010-1:2010 specifies the pollution degrees and their requirements as follows. The ASR-6000 falls under degree 2. Pollution refers to “addition of foreign matter, solid, liquid, or gaseous (ionized gases), that may produce a reduction of dielectric strength or surface resistivity”.
- Pollution degree 1: No pollution or only dry, non-conductive pollution occurs. The pollution has no influence.
 - Pollution degree 2: Normally only non-conductive pollution occurs. Occasionally, however, a temporary conductivity caused by condensation must be expected.
 - Pollution degree 3: Conductive pollution occurs, or dry, non-conductive pollution occurs which becomes conductive due to condensation which is expected. In such conditions, equipment is normally protected against exposure to direct sunlight, precipitation, and full wind pressure, but neither temperature nor humidity is controlled.

- Storage environment
- Location: Indoor
 - Temperature: -10°C to 70°C
 - Relative Humidity: ≤90%, no condensation

Disposal



Do not dispose this instrument as unsorted municipal waste. Please use a separate collection facility or contact the supplier from which this instrument was purchased. Please make sure discarded electrical waste is properly recycled to reduce environmental impact.

G E T T I N G S T A R T E D

This chapter describes the ASR-6000 power supply in a nutshell, including its main features and front / rear panel introduction.

ASR-6000 series



ASR-6000 Series Overview	9
Series lineup.....	9
Main Features.....	10
Accessories	11
Appearance	13
Front Panel	13
Rear Panel	18

ASR-6000 Series Overview

Series lineup

The ASR-6000 series consists of 2 models, the ASR-6450 and ASR-6600, differing in capacity. Note that throughout the user manual, the term “ASR-6000” refers to any of the models, unless stated otherwise.

1P Output Condition

Model Name	Power Rating	Max. Output Current	Max. Output Voltage
ASR-6450	4500 VA	45 / 22.5 A	350 Vrms / 500 Vdc
ASR-6600	6000 VA	60 / 30 A	350 Vrms / 500 Vdc

1P3W Output Condition

Model Name	Power Rating	Max. Output Current	Max. Output Voltage
ASR-6450	3000 VA	15 / 7.5 A	700 Vrms / 1000 Vdc
ASR-6600	4000 VA	20 / 10 A	700 Vrms / 1000 Vdc

3P Output Condition (Pre phase)

Model Name	Power Rating	Max. Output Current	Max. Output Voltage
ASR-6450	1500 VA	15 / 7.5 A	350 Vrms / 500 Vdc
ASR-6600	2000 VA	20 / 10 A	350 Vrms / 500 Vdc

Main Features

- | | |
|-------------|---|
| Performance | <ul style="list-style-type: none">• Maximum phase voltage is 350 Vrms, line voltage is 700 Vrms• Maximum DC output voltage is 1000 Vdc• Maximum output frequency is 2000 Hz• Adjustable Voltage rising time• DC full capacity output ability• Output voltage total harmonic distortion is less than 0.3% at 50 and 60 Hz• Maximum crest factor reached 4 times |
| Features | <ul style="list-style-type: none">• Include sine, square, triangle, arbitrary and DC output waveforms• Variable voltage, frequency and current limiter• 100 steps Harmonic voltage and current analysis ability• Supported three phase unbalanced output mode• Sequence, simulate and preset memory functions• AC line frequency synchronized output• USB memory save and recall• Remote sense compensator• Supported 1P, 1P3W and 3P output phase• External control I/O and signal input applications• Voltage and current monitor output• Voltage control amplifier output• PC software, web control and data log functions |
| Interface | <ul style="list-style-type: none">• Built-in LAN, USB host, USB device and RS232 interface• Optional GPIB, DeviceNet and CAN BUS interface |

Accessories

Before using the ASR-6000 power source unit, check the package contents to make sure all the standard accessories are included.

Standard Accessories	Part number	Description
		Quick Start Guide
	82GW1SAFE0M*1	Safety guide
	62SR-6K0SC401	Input terminal cover
	62SR-6K0SC301	Output terminal cover
	62SR-6K0CP101	Copper plate for delta connection input (Mark 1)
	62SR-6K0CP201	Copper plate for single phase and Y connection input (Mark 2)
	62SR-6K0CP301	Copper plate for delta connection input (Mark 3)
	62SR-6K0CP401	Copper plate for 1P output (Mark 4)
	GRA-451-E	Rack mount adapter (EIA)
	GTL-246	USB cable (USB 2.0 Type A - Type B cable, approx. 1.2M)
Optional Accessories	Part number	Description
	GRA-451-J	Rack mount adapter (JIS)
	GPW-008	Power Cord SJT 10AWG/3C, 3m Max Length, 105oC, RV5-5*3P, RV5-5*3P UL TYPE
	GPW-009	Power Cord H05VV-F 2.5mm ² /3C, 3m Max Length, 105oC, RVS3-5*3P, RVS3-5*3P VDE TYPE

GPW-010	Power Cord VCTF 2.0mm2/3C, 3m Max Length, 105oC, RVS2-5*3P, RVS2-5*3P PSE TYPE
GPW-011	Power Cord SJT 10AWG/5C, 3m Max Length, 105oC, RV5-5*5P, RV5-5*5P UL TYPE
GPW-012	Power Cord H05VV-F 2.5mm2/5C, 3m Max Length, 105oC, RVS3-5*5P, RVS3-5*5P VDE TYPE
GPW-013	Power Cord VCTF 2.0mm2/5C, 3m Max Length, 105oC, , RVS2-5*5P, RVS2-5*5P PSE TYPE
GPW-014	Power Cord SJT 10AWG/4C, 3m Max Length, 105oC, RV5-5*4P, RV5-5*4P UL TYPE
GPW-015	Power Cord H05VV-F 2.5mm2/4C, 3m Max Length, 105oC, RVS3-5*4P, RVS3-5*4P VDE TYPE
GPW-016	Power Cord VCTF 2.0mm2/4C, 3m Max Length, 105oC, , RVS2-5*4P, RVS2-5*4P PSE TYPE
GTL-232	RS232C cable, approx. 2M
GTL-248	GPIB cable, approx. 2M
ASR-003	GPIB interface card
ASR-004	DeviceNet interface card
ASR-005	CAN BUS interface card
ASR-006	External parallel cable



Note

- GPW-008, 009, 010 are for single phase input only.
- GPW-011, 012, 013 are for Y connection input only.
- GPW-014, 015, 016 are for Delta connection input only.

Appearance

Front Panel

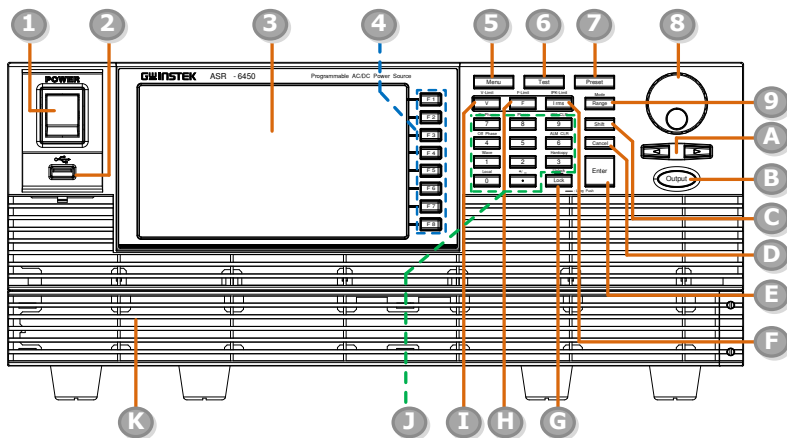



Item Index	Description
1	Power switch button
2	USB interface connector (A Type)
3	LCD screen
4	Function keys (blue zone)
5	Menu key
6	Test key
7	Preset key
8	Scroll wheel
9	Range key/Output mode key
A	Arrow keys
B	Output key
C	Shift key

D	Cancel key
E	Enter key
F	Irms/IPK-Limit button
G	Lock/Unlock button
H	F/F-Limit button
I	V/V-Limit button
J	Numerical Keypad with additional “Shift + key” shortcut functions (green zone)
K	Air inlet



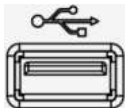









Item	Description
------	-------------

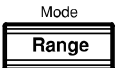

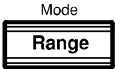





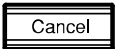

Power Switch		Turn on the mains power
--------------	---	-------------------------



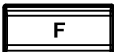

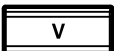

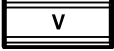

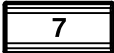

USB A Port		<p>The USB port is used for data transfers and upgrading software. Also, it is available for screenshot hardcopy.</p> <p> It supports FAT32 format with maximum 32G storage.</p>
------------	---	---

LCD Screen	Displays the setting and measured values or menu system
------------	---

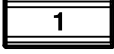
Function Keys		Assigned to the functions displayed on the right side of the screen.
---------------	---	--

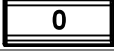
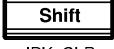
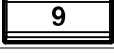
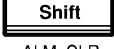
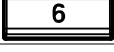
Menu Key		Enters the Main menu or goes back to one of the display modes.
Test Key		Puts the instrument into the Sequence and Simulation control mode.
Preset Key		Puts the instrument into Preset mode.
Arrow Keys		The arrow keys are used to select the digit power of a value that is being edited.
Range Key		Switches between the 100V, 200V and AUTO ranges
Output Mode	 + 	Selects between the AC+DC-INT, AC-INT, DC-INT, AC+DC-EXT, AC-EXT, AC+DC-ADD, AC-ADD, AC+DC-Sync, AC-Sync and AC-VCA modes.
Scroll Wheel		Used to navigate menu items or for increment/decrement values one step at a time.
Output Key		Turns the output on or off.
Shift Key		Turns on the shift state, which enables shortcut operations with an icon  indicated on the top status bar. The shift state, which allows continuous shortcut operations, is kept until another press on shift key again.
		When performing shortcut operations, press shift key followed by another shortcut function key. Do Not press both shift key and shortcut function key simultaneously.
Cancel Key		Used to cancel function setting menus or dialogs.

Enter Key		Confirms selections and settings.
Irms	<p style="text-align: center;">IPK-Limit</p> 	Used for setting the maximum output current.
IPK-Limit	<p style="text-align: center;">Shift</p> <p style="text-align: center;">+ IPK-Limit</p>  <p style="text-align: center;">Irms</p> 	Used to set the peak output current limit value.
Lock/Unlock Key	<p style="text-align: center;">Unlock</p>  <p style="text-align: center;">Lock</p> <p style="text-align: center;">— : Long Push</p>	Used to lock or unlock the front panel keys except output key. Simply press to lock, whilst long press to unlock.
F	<p style="text-align: center;">F-Limit</p> 	Used for setting the output frequency (DC mode N/A).
F-Limit	<p style="text-align: center;">Shift</p> <p style="text-align: center;">+ F-Limit</p>  <p style="text-align: center;">F</p> 	Used for setting the output frequency limit value (DC mode N/A).
V	<p style="text-align: center;">V-Limit</p> 	Used for setting the output voltage.
V-Limit	<p style="text-align: center;">Shift</p> <p style="text-align: center;">+ V-Limit</p>  <p style="text-align: center;">V</p> 	Used for setting the output voltage limit value.
Keypad		Used to input power of a value directly. The  key is used to input decimal / plus or minus.

On Phase	 <small>On Phase</small>	+ Sets the on phase for the output voltage.
		
<hr/>		
Off Phase	 <small>Off Phase</small>	+ Sets the off phase for the output voltage.
		
<hr/>		
Output Waveform	 <small>Wave</small>	+ Selects between the Sine, Square, Triangle and ARB 1~253 waveforms (not available for DC-INT, AC+DC-EXT and AC-EXT).
		
<hr/>		
Local Mode	 <small>Local</small>	+ Switches operation back to local mode from remote mode.
		
<hr/>		
IPK CLR	 <small>IPK CLR</small>	+ Used to clear peak output current value.
		
<hr/>		
ALM CLR	 <small>ALM CLR</small>	+ Clears alarms.
		
<hr/>		
Hardcopy Key	 <small>Hardcopy</small>	+ Used to take a screenshot. Make sure an USB flash disk is well inserted before the action.
		
<hr/>		
Output Phase	 <small>Phase</small>	+ Used to switch output phase 1P2W,1P3W or 3P4W.
		

Rear Panel

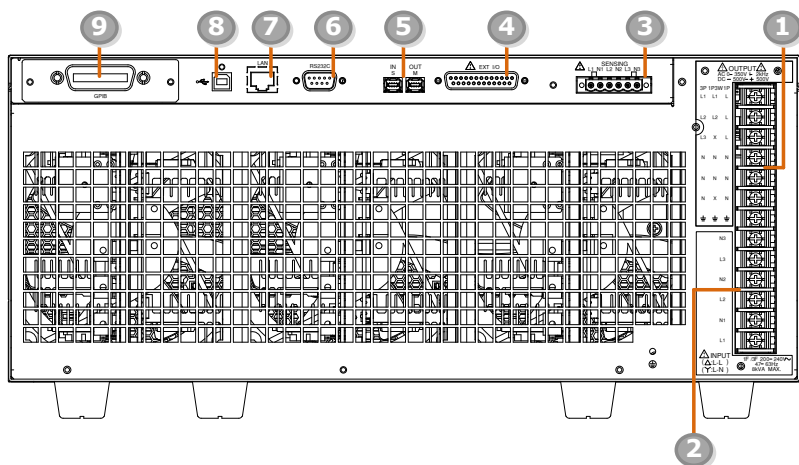

Item Index	Description
1	Output terminal
2	AC power input terminal
3	Remote sensing input terminal
4	External I/O connector
5	External IN/OUT connection in parallel function
6	RS232 connector
7	Ethernet (LAN) connector
8	USB interface connector (B Type)
9	Optional interface Slot <ul style="list-style-type: none"> ▪ GPIB card (ASR-003) ▪ DeviceNet card (ASR-004) ▪ CAN BUS card (ASR-005)

Item	Description
Output Terminal	<div data-bbox="397 223 588 550" style="display: inline-block; vertical-align: top;"> <p style="font-size: small; margin-top: 5px;"> OUTPUT AC 0-350V ± 20Hz DC 0-500V ± 500V </p> </div> <div data-bbox="593 223 985 327" style="display: inline-block; vertical-align: top; padding-left: 20px;"> <p>Output terminal (M4 screw type, 8 ~ 18 AWG) (Screw torque value:18kgf-cm)</p> </div>
AC Power Input Terminal	<div data-bbox="397 582 588 877" style="display: inline-block; vertical-align: top;"> <p style="font-size: small; margin-top: 5px;"> INPUT (Δ:L-L) (Y:L-N) </p> <p style="font-size: x-small; margin-top: 5px;"> 1Φ/3Φ 200-240V~ 47-63Hz 8kVA MAX. </p> </div> <div data-bbox="593 582 985 686" style="display: inline-block; vertical-align: top; padding-left: 20px;"> <p>AC inlet (M4 screw type, 8 ~ 18 AWG) (Screw torque value:18kgf-cm)</p> </div>
Remote Sensing Input Terminal	<div data-bbox="397 909 588 997" style="display: inline-block; vertical-align: top;"> <p style="font-size: small; margin-top: 5px;"> SENSING L1 N1 L2 N2 L3 N3 </p> </div> <div data-bbox="593 901 985 1101" style="display: inline-block; vertical-align: top; padding-left: 20px;"> <p>Remote sensing input terminal is for compensation of load wire voltage drop. (M2.5 screw type, 12 ~ 30 AWG) (Screw torque value: 0.5N*m) (Strip length: 7 ~ 8mm)</p> </div>
External Control I/O Connector	<div data-bbox="397 1133 588 1204" style="display: inline-block; vertical-align: top;"> <p style="font-size: small; margin-top: 5px;"> EXT I/O </p> </div> <div data-bbox="593 1133 985 1236" style="display: inline-block; vertical-align: top; padding-left: 20px;"> <p>Used to control ASR-6000 externally by using the logic signal and monitor Sequence function status.</p> </div>
External IN/OUT Connection in Parallel Function	<div data-bbox="397 1268 588 1361" style="display: inline-block; vertical-align: top;"> <p style="font-size: small; margin-top: 5px;"> IN S OUT M </p> </div> <div data-bbox="593 1268 985 1361" style="display: inline-block; vertical-align: top; padding-left: 20px;"> <p>The IN (Slave) and OUT (Master) ports are used for connection with external unit in parallel function.</p> </div>

RS232C
Connector

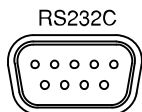

The RS232C connector for controlling the ASR-6000 remotely.

Ethernet LAN
Port

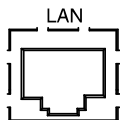

The Ethernet port is used for remote control.

USB B-type Port



USB port for controlling the ASR-6000 remotely.

Optional GPIB
Connector



The optional GPIB connector for controlling the ASR-6000 remotely.

Optional CAN
BUS Connector

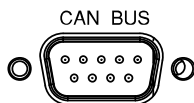

The optional CAN BUS connector for controlling the ASR-6000 remotely.

Optional
DeviceNet
Connector

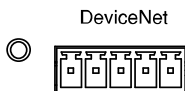

The optional DeviceNet connector for controlling the ASR-6000 remotely.

REMOTE CONTROL

This chapter describes basic configuration of IEEE488.2 based remote control.

Interface Configuration	23
Ethernet Remote Interface	23
USB Remote Interface	24
USB Remote Control Function Check	25
RS-232 Remote Interface	26
RS232 Remote Control Function Check	29
Using Realterm to Establish a Remote Connection	30
Optional Remote Interface	33
GPIB Function Check	34
Web Server Remote Control Function Check	38
Socket Server Function Check	39
Command Syntax	44
Command List	48
Status Register Overview	169
Introduction to the Status Registers	169
The Status Registers	170
Questionable Status Register Group	171
Operation Status Register Group	174
Warning Status Register Group	176
System Lock Status Register Group	179
Standard Event Status Register Group	181
Status Byte Register & Service Request Enable Register	183

Error List.....	185
Command Errors	185
Execution Errors	189
Device Specific Errors.....	191
Query Errors.....	192

Interface Configuration

Ethernet Remote Interface



The Ethernet interface can be configured for a number of different applications. Ethernet can be configured for basic remote control or monitoring using a web server or it can be configured as a socket server.

The ASR-6000 supports both DHCP connections so the instrument can be automatically connected to an existing network or alternatively, network settings can be manually configured.

However, if the DHCP is not present, it will automatically assign an IP address between 169.254.1.0 and 169.254.254.255 using the AUTO-IP configuration when the instrument set on DHCP.

Ethernet Parameters	Connection Status (display only)	MAC (display only)
	DHCP	IP Address
	Subnet Mask	Gateway
	DNS	Socket Port (display only)

Ethernet Configuration

1. Connect a LAN cable from the PC to the Ethernet port on the rear panel. 
2. Press the *Menu* key. The Menu setting will appear on the display. 
3. Use the scroll wheel to go to item 3, *LAN* and press *Enter*.
4. If the LAN cable is installed correctly a connection is active, the *Connection Status* will show *Online*.

Steps

1. Connect the Type A-Type B USB cable from the PC to the rear panel USB B port.



2. Press the *Menu* key. The Menu setting will appear on the display.



3. Use the scroll wheel to go to item 4, *USB Device*.

Mode CDC, TMC

4. If the connection is successful *Connection Status* will change from Offline to Online.

USB configuration



Exit

5. Press *Exit[F8]* to exit from the rear panel USB settings.



USB Remote Control Function Check

Functionality Check

Invoke a terminal application such as Realterm.

ASR-6000 will appear as a COM port on the PC.

To check the COM settings in Windows, see the Device Manager. For example, in Win10 go to the Control panel → System → Hardware tab.



If you are not familiar with using a terminal application to send/receive remote commands via a

USB connection, please see page 30 for more information.

Run this query command via the terminal after the instrument has been configured for USB remote control (page 24).

*IDN?

This should return the Manufacturer, Model number, Serial number, and Software version in the following format.

GW-INSTEK, ASR-6XXX, GXXXXXXXX, XX.XX

Manufacturer: GW-INSTEK

Model number : ASR-6XXX

Serial number : GXXXXXXXX

Software version : XX.XX



Note

For further details, please see the programming manual, available on the GW Instek web site @ www.gwinstek.com.

RS-232 Remote Interface

RS-232 Configuration	Connector	BD-9, male
	Parameters	Baud rate, data bits, parity, stop bits.

Pin Assignment

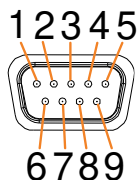

- 2: RxD (Receive data)
- 3: TxD (Transmit data)
- 5: GND
- 4, 6 ~ 9: No connection

Pin Connection

Use a Null Modem connection (RS-232 cable) as shown in the diagram below.

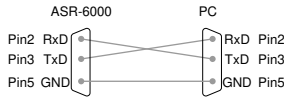

Steps

1. Connect the RS-232C cable from the PC to the rear panel RS-232 port.

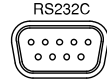

2. Press the *Menu* key. The Menu setting will appear on the display.



3. Use the scroll wheel to go to item 5, RS232C and press *Enter*.

4. Set the RS232C relative settings.

Baud rate	1200, 2400, 4800, 9600(default), 19200, 38400, 57600, 115200,
-----------	--

Data bits	7 bits, 8 bits(default)
-----------	-------------------------

Parity	None(default), Odd, Even
--------	--------------------------

Stop bits	1 bit(default), 2 bits
-----------	------------------------

RS232C Configuration



Exit

5. Press *Exit[F8]* to exit from the RS232C settings.





Note

The standard accessory does Not include RS232 data cable. Please purchase the additional GTL-232 which will meet your need for RS232 connection.

RS232 Remote Control Function Check

Functionality
Check

Invoke a terminal application such as Realterm.

For RS-232, set the COM port, baud rate, stop bit, data bit and parity accordingly.

To check the COM settings in Windows, see the Device Manager. For example, in Win10 go to the Control panel → System → Hardware tab.



Note

If you are not familiar with using a terminal application to send/receive remote commands from the serial port, please see page 30 for more information.

Run this query command via the terminal after the instrument has been configured for RS-232 remote control (page 26).

*IDN?

This should return the Manufacturer, Model number, Serial number, and Software version in the following format.

GW-INSTEK, ASR-6XXX, GXXXXXXXX, XX.XX

Manufacturer: GW-INSTEK

Model number : ASR-6XXX

Serial number : GXXXXXXXX

Software version : XX.XX



Note

For further details, please see the programming manual, available on the GW Instek web site @ www.gwinstek.com.

Using Realterm to Establish a Remote Connection

Background Realterm is a terminal program that can be used to communicate with a device attached to the serial port of a PC or via an emulated serial port via USB.

The following instructions apply to version 2.0.0.70. Even though Realterm is used as an example to establish a remote connection, any terminal program can be used that has similar functionality.



Note

Realterm can be downloaded on Sourceforge.net free of charge.

For more information please see <http://realterm.sourceforge.net/>

- Operation**
1. Download Realterm and install according to the instructions on the Realterm website.
 2. Connect the ASR-6000 via USB (page 24) or via RS-232 (page 26).
 3. If using RS-232, make note of the configured baud rate, stop bits and parity.
 4. Go to the Windows device manager and find the COM port number for the connection. For example, go to the Start menu > Control Panel > Device Manager.

Double click the *Ports* icon to reveal the connected serial port devices and the COM port for the each connected device.

If using USB, the baud rate, stop bit and parity settings can be viewed by right-clicking the connected device and selecting the *Properties* option.

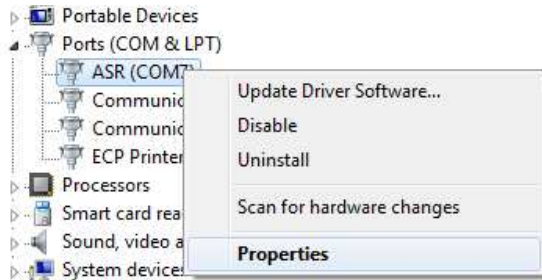

5. Start Realterm on the PC as an administrator.
Click:
Start menu>All Programs>RealTerm>realterm

Tip: to run as an administrator, you can right click the Realterm icon in the Windows Start menu and select the *Run as Administrator* option.

6. After Realterm has started, click on the *Port* tab.

Enter the *Baud*, *Parity*, *Data bits*, *Stop bits* and *Port number* configuration for the connection.

The *Hardware Flow Control*, *Software Flow Control* options can be left at the default settings.

Press *Open* to connect to the ASR-6000.

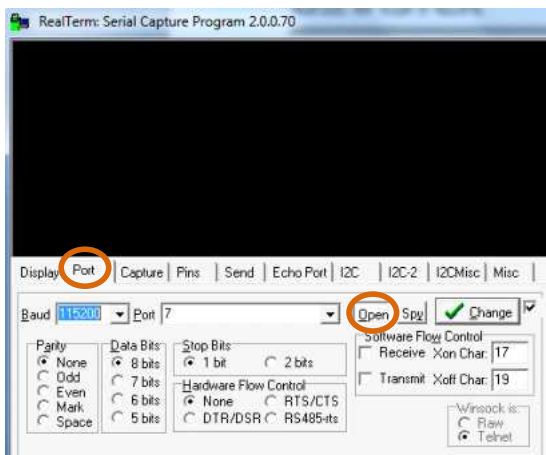

Note

For USB, the baud rate should be fixed to 115,200.

7. Click on the *Send* tab.

In the *EOL* configuration, check on the *+LF* check boxes.

Enter the query:

**idn?*

Click on *Send ASCII*.

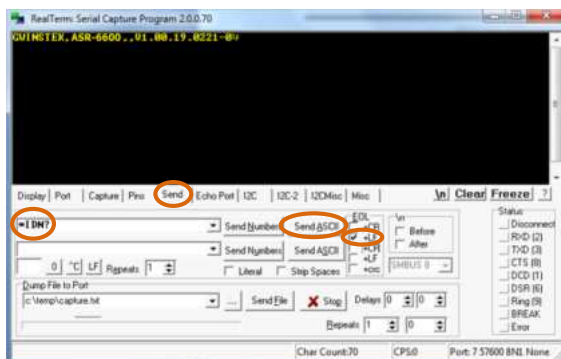

8. The terminal display will return the following:

GW-INSTEK, ASR-6XXX, GXXXXXXXXX, XX.XX
(manufacturer, model, serial number, software version)

9. If Realterm fails to connect to the ASR-6000, please check all the cables and settings and try again.

Optional Remote Interface

There are up to 3 optional remote interfaces available (GPIB, CAN BUS, DeviceNet) and we simply engage in GPIB here due to SCPI-format programming document. For information related to other remote interfaces like CAN BUS & DeviceNet, please refer to CAN BUS and DeviceNet programming manual, respectively.

GPIB Configuration

1. Connect a GPIB cable from the PC to the GPIB port on the rear panel.

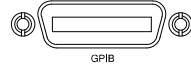

2. Press the *Menu* key. The Menu setting will appear on the display.



3. Use the scroll wheel to go to item 6, *Option Interface* and press *Enter*.
4. Set the GPIB address.

GPIB Address	0 ~ 30 (10 by default)
--------------	------------------------

GPIB Configuration



Note

- Only one GPIB address can be used at a time.
- ASR-6000 series can detect optional interface card automatically and the corresponding option interface page will be displayed accordingly.

Exit

5. Press *Exit*[F8] to exit from the GPIB settings.



GPIB Constraints

- Maximum 15 devices altogether, 20m cable length, 2m between each device
- Unique address assigned to each device
- At least 2/3 of the devices turned On
- No loop or parallel connection



Note

The standard accessory does Not include GPIB data cable. Please purchase the additional GTL-248 which will meet your need for GPIB connection.

GPIB Function Check

Functionality
Check

Please use the National Instruments Measurement & Automation Controller software to confirm GPIB/LAN functionality.

See the National Instrument website, <http://www.ni.com> for details.



Note

- For further details, please see the programming manual, available on the GW Instek web site @ www.gwinstek.com
- Operating System: Windows XP, 7, 8, 10

Operation

1. Start the NI Measurement and Automation Explorer (MAX) program. Using Windows, press:



Start>All Programs>NI MAX



2. From the Configuration panel access;
My System>Devices and Interfaces>GPIB0

3. Press the *Scan for Instruments* button.
4. In the *Connected Instruments* panel the ASR-6000 should be detected as *Instrument 0* with the address the same as that configured on the ASR-6000.
5. Double click the *Instrument 0* icon.

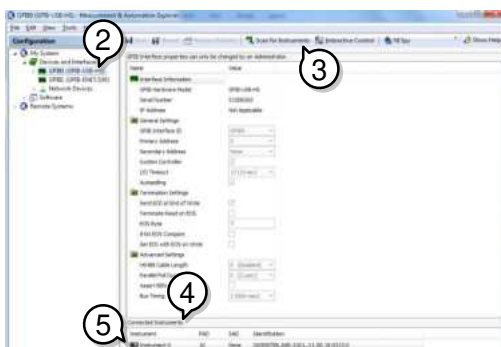

6. Click on *Communicate with Instrument*.
7. Under the Communicator tab, ensure **IDN?* is written in the *Send String* text box.
8. Click on the *Query* button to send the **IDN?* query to the instrument.
9. The instrument identification string will be returned to the buffer area:

GW-INSTEK, ASR-6XXX, GXXXXXXXXX, XX.XX
 (manufacturer, model, serial number, software version)

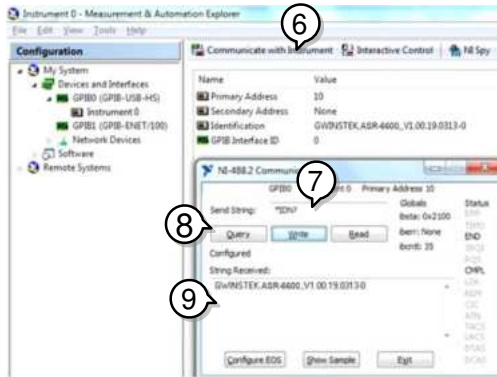

10. The function check is complete.

Web Server Remote Control Function Check

Functionality Check

Enter the IP address of the power supply (for example: `http://XXX.XXX.XXX.XXX`) in a web browser after the instrument has been configured for LAN (page 23).

The web interface allows you to:

- View the system and information and the network configuration.
- Monitor of measurements and/or full control of the power supplies. If the operator is not near the actual instruments being controlled, particular care must be taken to the appropriate access control limits.

Example:



Socket Server Function Check

Background To test the socket server functionality, National Instruments Measurement and Automation Explorer can be used. This program is available on the NI website, www.ni.com, via a search for the VISA Run-time Engine page, or “downloads” at the following URL, <http://www.ni.com/visa/>

Requirements Operating System: Windows XP, 7, 8, 10

Functionality Check 1. Start the NI Measurement and Automation Explorer (MAX) program. Using Windows, press:

Start>All Programs>NI MAX



2. From the Configuration panel access;

My System>Devices and Interfaces>Network Devices

3. Press *Add New Network Device>Visa TCP/IP Resource...*

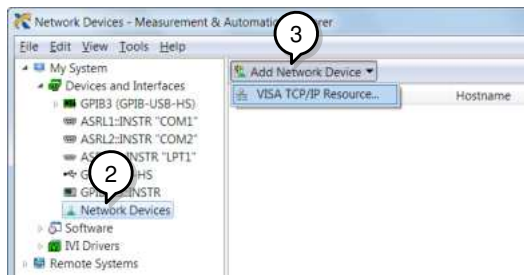

4. Select *Manual Entry of Raw Socket* from the popup window.

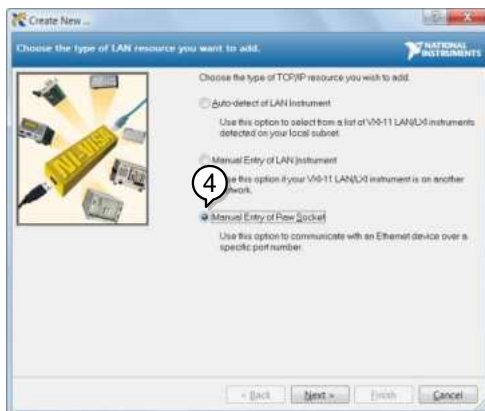

5. Enter the IP address and the port number of the ASR-6000. The port number is fixed at 5025.
6. Double click the Validate button and press *Next*.

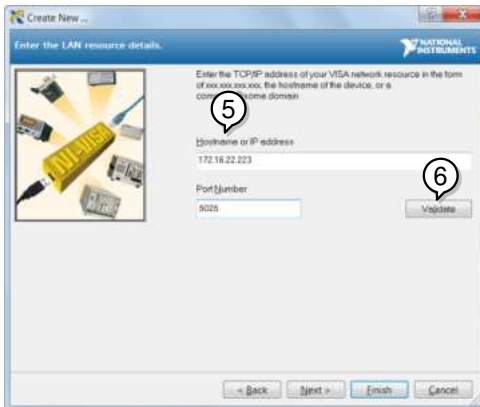

- Next configure the Alias (name) of the ASR-6000 connection. In this example the Alias is: ASR
- Click finish.



- The IP address of the power supply will now appear under Network Devices in the configuration panel. Select this icon now.
- Press *Open VISA Test Panel*.

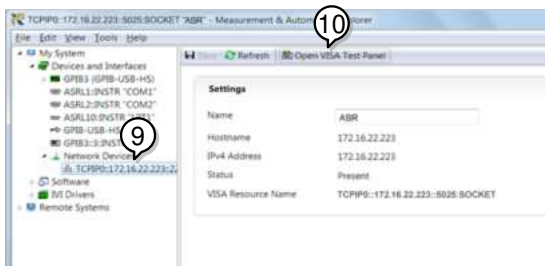

11. Click the *Configuration* Icon. Under the *IO Settings* tab check *Enable Termination Character*. The termination character should be set as *Line Feed - \n*.



12. Click the *Input/Output* icon. Under the *Basic I/O* tab, make sure **IDN?\n* is entered in the *Select or Enter Command* drop box.
13. Click *Query*.

The ASR-6000 will return the machine identification string into the buffer area:

GW-INSTEK, ASR-6XXX, GXXXXXXXXX, XX.XX



Note

For further details, please see the programming manual, available on the GW Instek web site @ www.gwinstek.com.

Command Syntax

Compatible Standard	IEEE488.2	Partial compatibility
	SCPI, 1999	Partial compatibility

Command Structure

SCPI commands follow a tree-like structure, organized into nodes. Each level of the command tree is a node. Each keyword in a SCPI command represents each node in the command tree. Each keyword (node) of a SCPI command is separated by a colon (:).

For example, the diagram below shows an SCPI sub-structure and a command example.

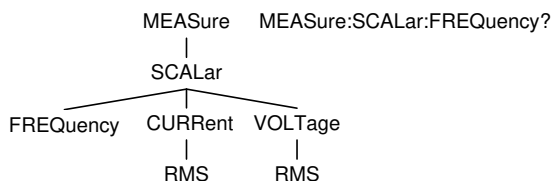

Command types

There are a number of different instrument commands and queries. A command sends instructions or data to the unit and a query receives data or status information from the unit.

Command types

Simple	A single command with/without a parameter
--------	---

Example	*IDN?
---------	-------

Query	A query is a simple or compound command followed by a question mark (?). A parameter (data) is returned.
-------	--

Example	meas:curr?
---------	------------

Compound	Two or more commands on the same command line. Compound commands are separated with either a semi-colon (;) or a semi-colon and a colon (;:).
----------	---

A semi-colon is used to join two related commands, with the caveat that the last command must begin at the last node of the first command.

Example	meas:volt?;curr?
---------	------------------

A semi-colon and colon are used to combine two commands from different nodes.

Example	meas:volt?;:sour:volt?
---------	------------------------

 Note
(Further explanation)

A semi-colon(;) is used to connect two commands. A colon(:) at the start of a command indicates that the command starts from the root node. The first command can ignore that first colon. Any commands after the first command (for compound commands) that do not begin with a colon, must begin at the last node of the first command.

Command Forms Commands and queries have two different forms, long and short. The command syntax is written with the short form of the command in capitals and the remainder (long form) in lower case.

The commands can be written in capitals or lower-case, just so long as the short or long forms are complete. An incomplete command will not be recognized.

Below are examples of correctly written commands.

Long form	:SYSTem:ERRor? :SYSTEM:ERROR? :system:error?
Short form	SYST:ERR? syst:err?

Square Brackets Commands that contain square brackets indicate that the contents are optional. The function of the command is the same with or without the square bracketed items, as shown below.

For example the query “:OUTPut[:STATe]?” has two valid forms, “:OUTPut:STATe?” and “:OUTPut?”.

Command Format		<ol style="list-style-type: none"> 1. Command header 2. Space 3. Parameter 1 4. Comma (no space before/after comma) 5. Parameter 2
	<p style="text-align: center;">1 2 3 4 5</p>	

Parameters	Type	Description	Example
	<Boolean>	Boolean logic	0, 1
	<NR1>	integers	0, 1, 2, 3
	<NR2>	decimal numbers	0.1, 3.14, 8.5
	<NR3>	floating point	4.5e-1, 8.25e+1
	<NRf>	any of NR1, 2, 3	1, 1.5, 4.5e-1
	<block data>	Definitive length arbitrary block data. A single decimal digit followed by data. The decimal digit specifies how many 8-bit data bytes follow.	

Message Terminator	LF	Line feed code	
--------------------	----	----------------	--

Command List

Common	*CLS.....	56
Commands	*ESE	56
	*ESR.....	57
	*IDN	57
	*OPC.....	57
	*RCL	58
	*RST	58
	*SAV	58
	*SRE.....	59
	*STB.....	59
	*WAI.....	59
Data/Trace	:DATA TRACe:SEQuence:CLear	60
Commands	:DATA TRACe:SEQuence:RECall	60
	:DATA TRACe:SEQuence:STORe	61
	:DATA TRACe:SIMulation:CLear	61
	:DATA TRACe:SIMulation:RECall	61
	:DATA TRACe:SIMulation:STORe	62
	:DATA TRACe:WAVe:CLear.....	62
	:DATA TRACe:WAVe[:DATA]	63
Measure	:MEASure[:SCALar]:CURRent:CFACtor	65
Commands	:MEASure[:SCALar]:CURRent:HIGH.....	65
	:MEASure[:SCALar]:CURRent:LOW	65
	:MEASure[:SCALar]:CURRent:PEAK:HOLD	65
	:MEASure[:SCALar]:CURRent[:RMS]	66
	:MEASure[:SCALar]:CURRent[:RMS]:TOTal.....	66
	:MEASure[:SCALar]:CURRent:AC	66
	:MEASure[:SCALar]:CURRent:AVERage	66
	:MEASure[:SCALar]:CURRent:HARMonic[:RMS] ..	66
	:MEASure[:SCALar]:CURRent:HARMonic:RATio..	67
	:MEASure[:SCALar]:FREQuency	67
	:MEASure[:SCALar]:LINE:VOLTage[:RMS]	67
	:MEASure[:SCALar]:LINE:VOLTage:AVERage....	67

:MEASure[:SCALar]:LINE:VOLTage:HIGH	68
:MEASure[:SCALar]:LINE:VOLTage:LOW	68
:MEASure[:SCALar]:PEAK:CLear	68
:MEASure[:SCALar]:POWer[:AC]:APParent	68
:MEASure[:SCALar]:POWer[:AC]:APParent:TOTal ..	69
:MEASure[:SCALar]:POWer[:AC]:PFActor	69
:MEASure[:SCALar]:POWer[:AC]:PFActor:TOTal ..	69
:MEASure[:SCALar]:POWer[:AC]:REACtive	69
:MEASure[:SCALar]:POWer[:AC]:REACtive:TOTal ..	69
:MEASure[:SCALar]:POWer[:AC][:REAL]	70
:MEASure[:SCALar]:POWer[:AC][:REAL]:TOTal ..	70
:MEASure[:SCALar]:VOLTage[:RMS]	70
:MEASure[:SCALar]:VOLTage[:RMS]:TOTal	70
:MEASure[:SCALar]:VOLTage:AC	70
:MEASure[:SCALar]:VOLTage:AVERage	71
:MEASure[:SCALar]:VOLTage:HIGH	71
:MEASure[:SCALar]:VOLTage:LOW	71
:MEASure[:SCALar]:VOLTage:HARMonic[:RMS] ..	72
:MEASure[:SCALar]:VOLTage:HARMonic:RATio ..	72
:MEASure:CONFigure:SENSing	72
:MEASure:AVERage:COUNt	73
:MEASure:UPDate:RATE	74
Fetch Commands :FETCh[:SCALar]:CURRent:CFACor	76
:FETCh[:SCALar]:CURRent:HIGH	76
:FETCh[:SCALar]:CURRent:LOW	76
:FETCh[:SCALar]:CURRent:PEAK:HOLD	76
:FETCh[:SCALar]:CURRent[:RMS]	77
:FETCh[:SCALar]:CURRent[:RMS]:TOTal	77
:FETCh[:SCALar]:CURRent:AC	77
:FETCh[:SCALar]:CURRent:AVERage	77
:FETCh[:SCALar]:CURRent:HARMonic[:RMS]	77
:FETCh[:SCALar]:CURRent:HARMonic:RATio	78
:FETCh[:SCALar]:FREQuency	78
:FETCh[:SCALar]:LINE:VOLTage[:RMS]	78
:FETCh[:SCALar]:LINE:VOLTage:AVERage	78
:FETCh[:SCALar]:LINE:VOLTage:HIGH	79
:FETCh[:SCALar]:LINE:VOLTage:LOW	79
:FETCh[:SCALar]:POWer[:AC]:APParent	79

	:FETCh[:SCALar]:POWer[:AC]:APParent:TOTal	79
	:FETCh[:SCALar]:POWer[:AC]:PFACtor	80
	:FETCh[:SCALar]:POWer[:AC]:PFACtor:TOTal	80
	:FETCh[:SCALar]:POWer[:AC]:REACTive.....	80
	:FETCh[:SCALar]:POWer[:AC]:REACTive:TOTal.....	80
	:FETCh[:SCALar]:POWer[:AC][:REAL]	80
	:FETCh[:SCALar]:POWer[:AC][:REAL]:TOTal.....	81
	:FETCh[:SCALar]:VOLTage[:RMS].....	81
	:FETCh[:SCALar]:VOLTage[:RMS]:TOTal.....	81
	:FETCh[:SCALar]:VOLTage:AC	81
	:FETCh[:SCALar]:VOLTage:AVERage	81
	:FETCh[:SCALar]:VOLTage:HIGH.....	82
	:FETCh[:SCALar]:VOLTage:LOW	82
	:FETCh[:SCALar]: VOLTage:HARMonic[:RMS]	82
	:FETCh[:SCALar]: VOLTage:HARMonic:RATio.....	83
Memory	:MEMory:RCL.....	84
Commands	:MEMory:SAV	84
Output	:OUTPut:IMPedance	85
Commands	:OUTPut:IMPedance:INDuctance.....	85
	:OUTPut:IMPedance:RESistance	86
	:OUTPut:MONitor:AMPLitude.....	87
	:OUTPut:MONitor:SOURce<1 2>	87
	:OUTPut[:STATe]	88
	:OUTPut:PON	88
	:OUTPut:PROTection:CLEar	89
	:OUTPut:RELay	89
Status	:STATus:OPERation:CONDition.....	90
Commands	:STATus:OPERation:ENABLE	90
	:STATus:OPERation[:EVENT]	91
	:STATus:OPERation:NTRansition.....	91
	:STATus:OPERation:PTRansition.....	91
	:STATus:QUEStionable[:EVENT]	92
	:STATus:QUEStionable:CONDition.....	92
	:STATus:QUEStionable:ENABLE	92

	:STATus:QUEStionable:NTRansition	92
	:STATus:QUEStionable:PTRansition	93
	:STATus:PRESet	93
	:STATus:WARNIing:CONDition	94
	:STATus:WARNIing:ENABle	94
	:STATus:WARNIing[:EVENt]	94
	:STATus:WARNIing:NTRansition	95
	:STATus:WARNIing:PTRansition	95
	:STATus:LOCK:CONDition	95
	:STATus:LOCK:ENABle	95
	:STATus:LOCK[:EVENt]	96
	:STATus:LOCK:NTRansition	96
	:STATus:LOCK:PTRansition	96
System	:SYSTem:ARBitrary:EDIT:BUILtin	98
Commands	:SYSTem:ARBitrary:EDIT:SURGe	99
	:SYSTem:ARBitrary:EDIT:STAir	99
	:SYSTem:ARBitrary:EDIT:CFACtor2	100
	:SYSTem:ARBitrary:EDIT:CFACtor1	100
	:SYSTem:ARBitrary:EDIT:CLIP	101
	:SYSTem:ARBitrary:EDIT:STORe	101
	:SYSTem:ARBitrary:EDIT:TRIangle	102
	:SYSTem:ARBitrary:EDIT:DIP	103
	:SYSTem:ARBitrary:EDIT:LFRing	104
	:SYSTem:ARBitrary:EDIT:RIPple	106
	:SYSTem:ARBitrary:EDIT:STORe:APPLy<1 3> ..	107
	:SYSTem:BEEPPer:STATe	108
	:SYSTem:COMMunicate:INTerface:ADDReSS	108
	:SYSTem:COMMunicate:INTerface:BAUD	108
	:SYSTem:COMMunicate:LAN:DHCP	109
	:SYSTem:COMMunicate:LAN:DNS	109
	:SYSTem:COMMunicate:LAN:GATeway	109
	:SYSTem:COMMunicate:LAN:IPADdress	110
	:SYSTem:COMMunicate:LAN:MAC	110
	:SYSTem:COMMunicate:LAN:SMASk	110
	:SYSTem:COMMunicate:RLState	111
	:SYSTem:COMMunicate:SERial[:RECeive]	
	:TRANsmIT:BAUD	112
	:SYSTem:COMMunicate:SERial[:RECeive]	

	:TRANsmit:BITS	112
	:SYSTem:COMMunicate:SERial[:RECeive]	
	:TRANsmit:PARity	113
	:SYSTem:COMMunicate:SERial[:RECeive]	
	:TRANsmit:SBITs	114
	:SYSTem:COMMunicate:TCPip:CONTRol.....	114
	:SYSTem:COMMunicate:USB:FRONt:STATe	115
	:SYSTem:COMMunicate:USB:REAR:STATe	115
	:SYSTem:CONFigure[:MODE]	115
	:SYSTem:CONFigure:EXTio[:STATe]	116
	:SYSTem:CONFigure:TRIGger:OUTPut:SOURce	116
	:SYSTem:CONFigure:TRIGger:OUTPut:WIDTh... ..	117
	:SYSTem:ERRor	117
	:SYSTem:ERRor:ENABle.....	117
	:SYSTem:HOLD:STATe.....	118
	:SYSTem:PKHold:TIME.....	118
	:SYSTem:KLOCK	118
	:SYSTem:REBoot.....	119
	:SYSTem:VUNit	119
Source	:SYSTem:CONFigure:PHASe.....	121
Commands	:INSTrument:EDIT	122
	:INSTrument:SELect.....	122
	[:SOURce]:CURRent:LIMit:PEAK:HIGH	123
	[:SOURce]:CURRent:LIMit:PEAK:LOW	123
	[:SOURce]:CURRent:LIMit:RMS[:AMPLitude]	124
	[:SOURce]:CURRent:LIMit:PEAK:MODE.....	124
	[:SOURce]:CURRent:LIMit:RMS:MODE	125
	[:SOURce]:FREQuency:LIMit:HIGH	125
	[:SOURce]:FREQuency:LIMit:LOW	126
	[:SOURce]:FREQuency[:IMMediate]	126
	[:SOURce]:FUNCTion[:SHAPE][:IMMediate]	127
	[:SOURce]:FUNCTion:THD:FORMat.....	129
	[:SOURce]:LINE:VOLTag[:LEVel][:IMMediate][:AMPLitude]	129
	[:SOURce]:LINE:VOLTag[:LEVel][:IMMediate]:OFFSet.....	130
	[:SOURce]:MODE.....	130
	[:SOURce]:PHASe:BALance	131

	[:SOURce]:PHASe:MODE	131
	[:SOURce]:PHASe:PHASe.....	132
	[:SOURce]:PHASe:RELock.....	132
	[:SOURce]:PHASe:SETChange:STATe.....	133
	[:SOURce]:PHASe:STARt:STATe	133
	[:SOURce]:PHASe:STOP:STATe	134
	[:SOURce]:PHASe:STARt[:IMMediate].....	134
	[:SOURce]:PHASe:STOP[:IMMediate]	135
	[:SOURce]:PHASe:SYNC[:IMMediate]	135
	[:SOURce]:READ	136
	[:SOURce]:VOLTag:RANGe	136
	[:SOURce]:VOLTag:RESPonse	137
	[:SOURce]:VOLTag:LIMit:RMS	137
	[:SOURce]:VOLTag:LIMit:PEAK.....	138
	[:SOURce]:VOLTag:LIMit:HIGH.....	138
	[:SOURce]:VOLTag:LIMit:LOW	139
	[:SOURce]:VOLTag[:LEVel][:IMMediate]	
	[:AMPLitude]	139
	[:SOURce]:VOLTag[:LEVel][:IMMediate]:OFFSet	140
	[:SOURce]:SQUare:DCYClE	140
Sequence	[:SOURce]:SEQuence:INSTrument:SELEct.....	141
Commands	[:SOURce]:SEQuence:CPARAmeter	142
	[:SOURce]:SEQuence:CSTep.....	143
	[:SOURce]:SEQuence:CTIME.....	143
	[:SOURce]:SEQuence:CJUMp:CNT	143
	[:SOURce]:SEQuence:NSPARAmeter	144
	[:SOURce]:SEQuence:SPARAmeter	145
	[:SOURce]:SEQuence:STEP	146
	[:SOURce]:SEQuence:CONDition	147
	:TRIGger:SEQuence:SELEcted:EXECute	147
Simulate	[:SOURce]:SIMulation:CONDition.....	149
Commands	[:SOURce]:SIMulation:ABNormal:CODE	149
	[:SOURce]:SIMulation:ABNormal:FREQuency	150
	[:SOURce]:SIMulation:ABNormal:PHASe	
	:STARt:ENABle.....	150
	[:SOURce]:SIMulation:ABNormal:PHASe	

:START[:IMMEDIATE]	151
[:SOURCE]:SIMULATION:ABNORMAL:PHASE	
:STOP:ENABLE	151
[:SOURCE]:SIMULATION:ABNORMAL:PHASE	
:STOP[:IMMEDIATE]	152
[:SOURCE]:SIMULATION:ABNORMAL:TIME	152
[:SOURCE]:SIMULATION:ABNORMAL:VOLTAGE	153
[:SOURCE]:SIMULATION:CSTEP	153
[:SOURCE]:SIMULATION:CTIME	154
[:SOURCE]:SIMULATION:CREPEAT:COUNT?	154
[:SOURCE]:SIMULATION:INITIAL:CODE	155
[:SOURCE]:SIMULATION:INITIAL:FREQUENCY	155
[:SOURCE]:SIMULATION:INITIAL:PHASE:START:ENABLE	
.....	156
[:SOURCE]:SIMULATION:INITIAL:PHASE:START[:IMMEDIATE]	
.....	156
[:SOURCE]:SIMULATION:INITIAL:PHASE:STOP:ENABLE	
.....	157
[:SOURCE]:SIMULATION:INITIAL:PHASE:STOP[:IMMEDIATE]	
.....	157
[:SOURCE]:SIMULATION:INITIAL:VOLTAGE	158
[:SOURCE]:SIMULATION:NORMAL<1 2>:CODE	158
[:SOURCE]:SIMULATION:NORMAL 1:FREQUENCY	159
[:SOURCE]:SIMULATION:NORMAL<1 2>	
:PHASE:START:ENABLE	159
[:SOURCE]:SIMULATION:NORMAL<1 2>	
:PHASE:START[:IMMEDIATE]	160
[:SOURCE]:SIMULATION:NORMAL<1 2>	
:PHASE:STOP:ENABLE	160
[:SOURCE]:SIMULATION:NORMAL<1 2>	
:PHASE:STOP[:IMMEDIATE]	161
[:SOURCE]:SIMULATION:NORMAL<1 2>:TIME	161
[:SOURCE]:SIMULATION:NORMAL 1:VOLTAGE	162
[:SOURCE]:SIMULATION:REPEAT:COUNT	162
[:SOURCE]:SIMULATION:REPEAT:ENABLE	163
[:SOURCE]:SIMULATION:TRANSITION<1 2>:TIME	163
[:SOURCE]:SIMULATION:TRANSITION<1 2>:CODE	164
:TRIGGER:SIMULATION:SELECTED:EXECUTE	164

Input Commands	:INPut:SOURce	165
	:INPut:GAIN.....	165
	:INPut:SYNC:SOURce.....	166
Display	:DISPlay[:WINDow]:DESIgn:MODE.....	167
Commands	:DISPlay[:WINDow]:MEASure:SOURce<1 2 3 4> .	167

Common Commands

*CLS.....	56
*ESE.....	56
*ESR.....	57
*IDN.....	57
*OPC.....	57
*RCL.....	58
*RST.....	58
*SAV.....	58
*SRE.....	59
*STB.....	59
*WAI.....	59

*CLS



Description The *CLS command clears all the event registers, including the status byte, event status and error queue.

Syntax *CLS

*ESE

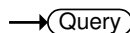
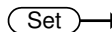

Description Sets or queries the Standard Event Status Enable register.

Syntax *ESE <NR1>

Query Syntax *ESE?

Parameter <NR1> 0~255

Return parameter <NR1> Returns the bit sum of the Standard Event Status Enable register.

***ESR**

→ Query

Description Queries the Standard Event Status (Event) register. The Event Status register is cleared after it is read.

Query Syntax *ESR?

Return parameter <NR1> Returns the bit sum of the Standard Event Status (Event) register and clears the register.

***IDN**

→ Query

Description Queries the manufacturer, model name, serial number, and firmware version of the ASR.

Query Syntax *IDN?

Return parameter <string> Returns the instrument identification as a string in the following format:
 GW-INSTEK,ASR-XXXX,GXXXXXXXX,XX.XX
 Manufacturer: GW-INSTEK
 Model number : ASR-XXXX
 Serial number : GXXXXXXXX
 Firmware version : XX.XX

***OPC**

→ Query

Description The *OPC? Query returns 1 when all the outstanding commands have completed.

Query Syntax *OPC?

Return parameter 1 Returns 1 when all the outstanding commands have completed.

***RCL**



Description Recalls the contents stored in memory slot M0 ~ M9. These memory slots are mapped to the preset settings.

Syntax *RCL {<NR1>|MINimum|MAXimum}

Parameter <NR1> 0 ~ 9 (as memory M0 ~ M9)
 MIN Recalls the M0 memory contents.
 MAX Recalls the M9 memory contents.

***RST**



Description Performs a device reset. Configures the unit to a known configuration (default settings). This known configuration is independent of the usage history.

Syntax *RST

***SAV**



Description Saves the settings into memory slot M0 ~ M9. These memory slots are mapped to the preset settings.

Syntax *SAV {<NR1>|MINimum|MAXimum}

Return parameter <NR1> 0 ~ 9 (as memory M0 ~ M9)
 MIN Saves to the M0 memory slot.
 MAX Saves to the M9 memory slot.

		Set →
		← Query
*SRE		
Description	Sets or queries the Service Request Enable register. The Service Request Enable register determines which registers of the Status Byte register are able to generate service requests.	
Syntax	*SRE <NR1>	
Query Syntax	*SRE?	
Parameter	<NR1>	0~255
Return parameter	<NR1>	Returns the bit sum of the Service Request Enable register.

		← Query
*STB		
Description	Queries the bit sum of the Status Byte register with MSS (Master summary Status) replacing the RQS bit (bit 6).	
Query Syntax	*STB?	
Return parameter	<NR1>	Returns the bit sum of the Status Byte register with the MSS bit (bit 6).

		Set →
*WAI		
Description	Prevents any other commands or queries from being executed until all outstanding commands have completed.	
Syntax	*WAI	

Trace/Data Commands



Note

The TRACE and DATA node for the following commands are functionally equivalent.

:DATA TRACe:SEQuence:CLEar	60
:DATA TRACe:SEQuence:RECall	60
:DATA TRACe:SEQuence:STORE	61
:DATA TRACe:SIMulation:CLEar	61
:DATA TRACe:SIMulation:RECall	61
:DATA TRACe:SIMulation:STORE	62
:DATA TRACe:WAVe:CLEar.....	62
:DATA TRACe:WAVe[:DATA]	63

:DATA|TRACe:SEQuence:CLEar



Description Clears the sequence data for the selected save memory (Seq0 ~ Seq9).

Syntax :DATA|TRACe:SEQuence:CLEar
{<NR1>|MINimum|MAXimum}

Parameter

<NR1>	0~9
MIN	0
MAX	9

Example :DATA:SEQ:CLE 1
Clears the sequence data from Seq1.

:DATA|TRACe:SEQuence:RECall



Description Loads the sequence data. This command is the equivalent to recalling a sequence memory in the Sequence mode.

Syntax :DATA|TRACe:SEQuence:RECall
{<NR1>|MINimum|MAXimum}

Parameter

<NR1>	0~9 (Seq0 ~ Seq9).
MIN	0

MAX 9

Example :DATA:SEQ:REC 1
Loads the data from Seq1.

:DATA|TRACe:SEQuence:STORe (Set) →

Description Saves the sequence data. This command is the equivalent to saving a sequence memory in Sequence mode.

Syntax :DATA|TRACe:SEQuence:STORe
{<NR1>|MINimum|MAXimum}

Parameter <NR1> 0~9 (Seq0 ~ Seq9).
MIN 0
MAX 9

Example :DATA:SEQ:STOR 1
Saves the data from Seq1.

:DATA|TRACe:SIMulation:CLEar (Set) →

Description Clears the simulation data for the selected save memory (SIM0 ~ SIM9).

Syntax :DATA|TRACe:SIMulation:CLEar
{<NR1>|MINimum|MAXimum}

Parameter <NR1> 0~9 (SIM0 ~ SIM9).
MIN 0
MAX 9

Example :DATA:SIM:CLE 1
Clears the simulation data from SIM1.

:DATA|TRACe:SIMulation:RECall (Set) →

Description Loads the simulation data. This command is the equivalent to recalling a simulation memory in the Simulation mode (SIM0~SIM9).

Syntax	:DATA TRACe:SIMulation:RECall {<NR1> MINimum MAXimum}
Parameter	<NR1> 0~9 (SIM0 ~ SIM9). MIN 0 MAX 9
Example	:DATA:SIM:REC 1 Loads the data from SIM1.

:DATA|TRACe:SIMulation:STORE Set →

Description	Saves the simulation data. This command is the equivalent saving a simulation memory in Simulation mode (SIM0 ~ SIM9).
Syntax	:DATA TRACe:SIMulation:STORE {<NR1> MINimum MAXimum}
Parameter	<NR1> 0~9 (SIM0 ~ SIM9). MIN 0 MAX 9
Example	:DATA:SIM:STOR 1 Saves the data from SIM1.

:DATA|TRACe:WAVe:CLEAr Set →

Description	Clears the ARB 1-253 data for the selected wave group.
Syntax	:DATA TRACe:WAVe:CLEAr {<NR1> MINimum MAXimum}
Parameter	<NR1> 1~253 (ARB1 ~ ARB253). MIN 1 (ARB1) MAX 253 (ARB253)
Example	:DATA:WAV:CLE 13 Clears the wave data from ARB13.

:DATA|TRACe:WAVE[:DATA]

Set →

Description	Sets the arbitrary wave.
Syntax	:DATA TRACe:WAVE[:DATA] {<NR1> <Binary Data>}
Parameter	<p><NR1> 1 - 253 (ARB 1 - 253)</p> <p>Binary Data includes the #48192<DAB>...<DAB></p> <p># Indicates the block data is sent.</p> <p>4 Indicates the number of subsequent numbers.</p> <p>8192 Indicates the number of subsequent byte data.</p> <p><DAB>.. Indicates 16-bit with 4096 words waveform data. Plus, the data format of wave is the big endian in the form of two's complement.</p> <p>.<DAB></p>
Example	TRAC:WAV 1, #48192<DAB>...<DAB>

Measure Commands

:MEASure[:SCALar]:CURRent:CFACtor	65
:MEASure[:SCALar]:CURRent:HIGH	65
:MEASure[:SCALar]:CURRent:LOW	65
:MEASure[:SCALar]:CURRent:PEAK:HOLD	65
:MEASure[:SCALar]:CURRent[:RMS]	66
:MEASure[:SCALar]:CURRent[:RMS]:TOTal.....	66
:MEASure[:SCALar]:CURRent:AC	66
:MEASure[:SCALar]:CURRent:AVERAge	66
:MEASure[:SCALar]:CURRent:HARMonic[:RMS] ..	66
:MEASure[:SCALar]:CURRent:HARMonic:RATio..	67
:MEASure[:SCALar]:FREQuency	67
:MEASure[:SCALar]:LINE:VOLTag[:RMS]	67
:MEASure[:SCALar]:LINE:VOLTag:AVERAge....	67
:MEASure[:SCALar]:LINE:VOLTag:HIGH	68
:MEASure[:SCALar]:LINE:VOLTag:LOW.....	68
:MEASure[:SCALar]:PEAK:CLEar.....	68
:MEASure[:SCALar]:POWer[:AC]:APParent	68
:MEASure[:SCALar]:POWer[:AC]:APParent:TOTal..	69
:MEASure[:SCALar]:POWer[:AC]:PFACtor.....	69
:MEASure[:SCALar]:POWer[:AC]:PFACtor:TOTal .	69
:MEASure[:SCALar]:POWer[:AC]:REACTive	69
:MEASure[:SCALar]:POWer[:AC]:REACTive:TOTal .	69
:MEASure[:SCALar]:POWer[:AC][:REAL]	70
:MEASure[:SCALar]:POWer[:AC][:REAL]:TOTal	70
:MEASure[:SCALar]:VOLTag[:RMS]	70
:MEASure[:SCALar]:VOLTag[:RMS]:TOTal	70
:MEASure[:SCALar]:VOLTag:AC.....	70
:MEASure[:SCALar]:VOLTag:AVERAge.....	71
:MEASure[:SCALar]:VOLTag:HIGH	71
:MEASure[:SCALar]:VOLTag:LOW.....	71
:MEASure[:SCALar]:VOLTag:HARMonic[:RMS]...	72
:MEASure[:SCALar]:VOLTag:HARMonic:RATio ..	72
:MEASure:CONFigure:SENSing	72
:MEASure:AVERAge:COUNT.....	73
:MEASure:UPDate:RATE.....	74

:MEASure[:SCALar]:CURRent:CFACtor → Query

Description Returns the output current crest factor (CF).

Query syntax :MEASure[:SCALar]:CURRent:CFACtor?

Return parameter <NR2> Returns the crest factor.

:MEASure[:SCALar]:CURRent:HIGH → Query

Description Returns the output current maximum peak value (Imax).

Note: Current maximum peak value is defined as the highest peak value in the complete period.

Query syntax :MEASure[:SCALar]:CURRent:HIGH?

Return parameter <NR2> Returns the Imax value in amps.

:MEASure[:SCALar]:CURRent:LOW → Query

Description Returns the output current minimum value (Imin).

Note: Current minimum value is defined as the lowest value in the complete period.

Query syntax :MEASure[:SCALar]:CURRent:LOW?

Return parameter <NR2> Returns the Imin value in amps.

:MEASure[:SCALar]:CURRent:PEAK:HOLD → Query

Description Returns the current peak hold value in amps (IPK Hold).

Query syntax :MEASure[:SCALar]:CURRent:PEAK:HOLD?

Return <NR2> Returns the peak hold value in amps.

:MEASure[:SCALar]:CURRent[:RMS] → Query

Description	Returns the output current (Irms).
Query syntax	:MEASure[:SCALar]:CURRent[:RMS]?
Return	<NR2> Returns the current value in Irms.

:MEASure[:SCALar]:CURRent[:RMS]:TOTal → Query

Description	Returns the total of output current (Irms).
Query syntax	:MEASure[:SCALar]:CURRent[:RMS]:TOTal?
Return	<NR2> Returns the total of current value in Irms.

:MEASure[:SCALar]:CURRent:AC → Query

Description	Returns the output AC current (Irms).
Query syntax	:MEASure[:SCALar]:CURRent:AC?
Return	<NR2> Returns the AC current value in Irms.

:MEASure[:SCALar]:CURRent:AVERage → Query

Description	Returns the current average value (Iavg).
Query syntax	:MEASure[:SCALar]:CURRent:AVERage?
Return	<NR2> Returns the current average value in amps.

:MEASure[:SCALar]:CURRent:HARMonic[:RMS] → Query

Description	Returns 101 values covering Total and order 1 to 100 current (Irms) in harmonic. (Only AC-INT and 50 /60 Hz Active)
Query syntax	:MEASure[:SCALar]:CURRent:HARMonic[:RMS]?
Return	<NR2>,<NR2 >,<NR2>,<NR2>..., etc. Returns the entire 101 values containing Total and order 1 to 100 current (Irms) in harmonic.

:MEASure[:SCALar]:CURRent:HARMonic:RATio → **Query**

Description Returns 101 values covering Total and order 1 to 100 current (Ratio) in harmonic. (Only AC-INT and 50 /60 Hz Active)

Query syntax :MEASure[:SCALar]:CURRent:HARMonic:RATio?

Return <NR2>,<NR2 >,<NR2>,<NR2>..., etc. Returns the entire 101 values containing Total and order 1 to 100 current (Ratio) in harmonic.

:MEASure[:SCALar]:FREQuency → **Query**

Description Returns the SYNC signal source frequency in Hz. The external sync signal frequency measurement range is 10.0 Hz to 2100.0 Hz. (Only AC+DC-sync or AC-sync Active)

Query syntax :MEASure[:SCALar]:FREQuency?

Return <NR2> Returns the SYNC frequency in Hz.

:MEASure[:SCALar]:LINE:VOLTage[:RMS] → **Query**

Description Returns the line voltage (Vrms).

Syntax :MEASure[:SCALar]:LINE:VOLTage[:RMS]?

Return <NR2> Returns the line voltage value in Vrms.

:MEASure[:SCALar]:LINE:VOLTage:AVERage → **Query**

Description Returns the line voltage average value (Vavg).

Syntax :MEASure[:SCALar]:LINE:VOLTage:AVERage?

Return <NR2> Returns the line voltage average value in volts.

:MEASure[:SCALar]:LINE:VOLTage:HIGH → (Query)

Description	Returns the output line voltage maximum peak value (Vmax).
Note:	Line voltage maximum peak value is defined as the highest peak value in the complete period.
Query syntax	:MEASure[:SCALar]:LINE:VOLTage:HIGH?
Return parameter	<NR2> Returns the line Vmax value in volts.

:MEASure[:SCALar]:LINE:VOLTage:LOW → (Query)

Description	Returns the output line voltage minimum value (Vmin).
Note:	Line voltage minimum value is defined as the lowest value in the complete period.
Query syntax	:MEASure[:SCALar]:VOLTage:LOW?
Return parameter	<NR2> Returns the line Vmin value in volts.

:MEASure[:SCALar]:PEAK:CLEAr (Set) →

Description	Clears the peak-hold value.	
Syntax	:MEASure[:SCALar]:PEAK:CLEAr <NR1> ALL L1 L2 L3	
Parameter	ALL 0	Clear the All phase peak hold value.
	L1 1	Clear L1 phase peak hold value.
	L2 2	Clear L2 phase peak hold value.
	L3 3	Clear L3 phase peak hold value.
Example	:MEASure[:SCALar]:PEAK:CLEAr ALL Clear the All phase peak hold value.	

:MEASure[:SCALar]:POWER[:AC]:APParent → (Query)

Description	Returns the apparent power (S).
Query syntax	:MEASure[:SCALar]:POWER[:AC]:APParent?

Return <NR2> Returns the apparent power in VA.

:MEASure[:SCALar]:POWer[:AC]:APParent:TOTal → **Query**

Description Returns the total of apparent power (S).

Query syntax :MEASure[:SCALar]:POWer[:AC]:APParent:TOTal?

Return <NR2> Returns the total of apparent power in VA.

:MEASure[:SCALar]:POWer[:AC]:PFACTOR → **Query**

Description Returns the power factor (PF).

Query syntax :MEASure[:SCALar]:POWer[:AC]:PFACTOR?

Return <NR2> Returns the power factor.

:MEASure[:SCALar]:POWer[:AC]:PFACTOR:TOTal → **Query**

Description Returns the total of power factor (PF).

Query syntax :MEASure[:SCALar]:POWer[:AC]:PFACTOR:TOTal?

Return <NR2> Returns the total of power factor.

:MEASure[:SCALar]:POWer[:AC]:REACTIVE → **Query**

Description Returns the reactive power (Q).

Query syntax :MEASure[:SCALar]:POWer[:AC]:REACTIVE?

Return <NR2> Returns the reactive power in VAR.

:MEASure[:SCALar]:POWer[:AC]:REACTIVE:TOTal → **Query**

Description Returns the total of reactive power (Q).

Query syntax :MEASure[:SCALar]:POWer[:AC]:REACTIVE:TOTal?

Return <NR2> Returns the total of reactive power in VAR.

:MEASure[:SCALar]:POWER[:AC][:REAL] → Query

Description Returns the active power in Watts (P).

Query syntax :MEASure[:SCALar]:POWER[:AC][:REAL]?

Return <NR2> Returns the power in Watts.

:MEASure[:SCALar]:POWER[:AC][:REAL]:TOTal → Query

Description Returns the total of active power in Watts (P).

Query syntax :MEASure[:SCALar]:POWER[:AC][:REAL]:TOTal?

Return <NR2> Returns the total of power in Watts.

:MEASure[:SCALar]:VOLTage[:RMS] → Query

Description Returns the voltage (Vrms).

Query syntax :MEASure[:SCALar]:VOLTage[:RMS]?

Return <NR2> Returns the voltage value in Vrms.

:MEASure[:SCALar]:VOLTage[:RMS]:TOTal → Query

Description Returns the total of voltage (Vrms).

Query syntax :MEASure[:SCALar]:VOLTage[:RMS]:TOTal?

Return <NR2> Returns the total of voltage value in Vrms.

:MEASure[:SCALar]:VOLTage:AC → Query

Description Returns the AC voltage (Vrms).

Query syntax :MEASure[:SCALar]:VOLTage:AC?

Return <NR2> Returns the AC voltage value in Vrms.

:MEASure[:SCALar]:VOLTage:AVERage → **Query**

Description	Returns the voltage average value (Vavg).
Query syntax	:MEASure[:SCALar]:VOLTage:AVERage?
Return	<NR2> Returns the voltage average value in volts.

:MEASure[:SCALar]:VOLTage:HIGH → **Query**

Description	Returns the output voltage maximum peak value (Vmax).
Note:	Voltage maximum peak value is defined as the highest peak value in the complete period.
Query syntax	:MEASure[:SCALar]:VOLTage:HIGH?
Return parameter	<NR2> Returns the Vmax value in volts.

:MEASure[:SCALar]:VOLTage:LOW → **Query**

Description	Returns the output voltage minimum value (Vmin).
Note:	Voltage minimum value is defined as the lowest value in the complete period.
Query syntax	:MEASure[:SCALar]:VOLTage:LOW?
Return parameter	<NR2> Returns the Vmin value in volts.

:MEASure[:SCALar]: VOLTage:HARMonic[:RMS] → (Query)

Description	Returns 101 values covering Total and order 1 to 100 voltage (Vrms) in harmonic. (Only AC-INT and 50 /60 Hz Active)
Query syntax	:MEASure[:SCALar]: VOLTage:HARMonic[:RMS]?
Return	<NR2>,<NR2 >,<NR2>,<NR2>..., etc. Returns the entire 101 values containing Total and order 1 to 100 voltage (Vrms) in harmonic.

:MEASure[:SCALar]: VOLTage:HARMonic:RATio → (Query)

Description	Returns 101 values covering Total and order 1 to 100 voltage (Ratio) in harmonic. (Only AC-INT and 50 /60 Hz Active)
Query syntax	:MEASure[:SCALar]: VOLTage:HARMonic:RATio?
Return	<NR2>,<NR2 >,<NR2>,<NR2>..., etc. Returns the entire 101 values containing Total and order 1 to 100 voltage (Ratio) in harmonic.

(Set) →

:MEASure:CONFigure:SENSing → (Query)

Description	Sets or queries the remote sense configuration. (Only AC-INT, DC-INT, AC-SYNC Mode and 100V, 200V Range and SIN Wave Shape and Output Impedance is Truned off)
Syntax	:MEASure:CONFigure:SENSing {<bool> OFF ON}
Query Syntax	:MEASure:CONFigure:SENSing?
Parameter	OFF 0 Turns the remote sense off. ON 1 Turns the remote sense on.
Return parameter	<bool> Returns the status of remote sense.
Example	:MEAS:CONF:SENS 0 Sets the remote sense off.

Set →

→ Query

:MEASure:AVERage:COUNT

Description	Sets or queries the averaging count for Measure Function.	
Syntax	:MEASure:AVERage:COUNT <NR1> MINimum MAXimum	
Query Syntax	:MEASure:AVERage:COUNT? [MINimum MAXimum]	
Parameter	<NR1>	1 ~ 128
	MINimum	1
	MAXimum	128
Return parameter	<NR1>	Returns the averaging count for Measure Function
Example	:MEASure:AVERage:COUNT? 1 Returns the averaging count for Measure Function	
Averaged Parameter	Vrms & Vmax & Vmin & Irms & Imax & Imin & P & S & Q & PF & CF & Vavg & Iavg	
Not Averaged Parameter	Vpkh & Ipkh & Freq & THDv & THDi	

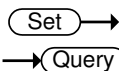

:MEASure:UPDate:RATE

Description	Sets or queries the data update interval for Measure Function.	
Syntax	:MEASure:UPDate:RATE <Time(NR2)> FAST	
Query Syntax	:MEASure:UPDate:RATE?	
Parameter	<Time(NR2)>	0.1 0.25 0.5 1 2 5 10 20
Return parameter	FAST	Select update rate at fast(update as soon as possible)
Example	:MEASure:UPDate:RATE? Fast Returns the data update interval for Measure Function	
Use Update Rate Parameter	Vrms & Vmax & Vmin & Irms & Imax & Imin & P & S & Q & PF & CF & Vavg & Iavg	
Not Use Update Rate Parameter	Vpkh & Ipkh & Freq & THDv & THDi (update as soon as possible)	

Fetch Commands

:FETCh[:SCALar]:CURRent:CFACor	76
:FETCh[:SCALar]:CURRent:HIGH	76
:FETCh[:SCALar]:CURRent:LOW	76
:FETCh[:SCALar]:CURRent:PEAK:HOLD	76
:FETCh[:SCALar]:CURRent[:RMS]	77
:FETCh[:SCALar]:CURRent[:RMS]:TOTal	77
:FETCh[:SCALar]:CURRent:AC.....	77
:FETCh[:SCALar]:CURRent:AVERAge.....	77
:FETCh[:SCALar]:CURRent:HARMonic[:RMS]	77
:FETCh[:SCALar]:CURRent:HARMonic:RATio.....	78
:FETCh[:SCALar]:FREQuency	78
:FETCh[:SCALar]:LINE:VOLTage[:RMS].....	78
:FETCh[:SCALar]:LINE:VOLTage:AVERAge	78
:FETCh[:SCALar]:LINE:VOLTage:HIGH.....	79
:FETCh[:SCALar]:LINE:VOLTage:LOW	79
:FETCh[:SCALar]:POWER[:AC]:APParent.....	79
:FETCh[:SCALar]:POWER[:AC]:APParent:TOTal.....	79
:FETCh[:SCALar]:POWER[:AC]:PFACTOR	80
:FETCh[:SCALar]:POWER[:AC]:PFACTOR:TOTal	80
:FETCh[:SCALar]:POWER[:AC]:REACTive	80
:FETCh[:SCALar]:POWER[:AC]:REACTive:TOTal.....	80
:FETCh[:SCALar]:POWER[:AC][:REAL].....	80
:FETCh[:SCALar]:POWER[:AC][:REAL]:TOTal.....	81
:FETCh[:SCALar]:VOLTage[:RMS]	81
:FETCh[:SCALar]:VOLTage[:RMS]:TOTal.....	81
:FETCh[:SCALar]:VOLTage:AC	81
:FETCh[:SCALar]:VOLTage:AVERAge	81
:FETCh[:SCALar]:VOLTage:HIGH.....	82
:FETCh[:SCALar]:VOLTage:LOW	82
:FETCh[:SCALar]:VOLTage:HARMonic[:RMS].....	82
:FETCh[:SCALar]:VOLTage:HARMonic:RATio.....	83

:FETCh[:SCALAr]:CURRent:CFACor → Query

Description Returns the read output current crest factor (CF).

Query syntax :FETCh[:SCALAr]:CURRent:CFACtor?

Return parameter <NR2> Returns the read crest factor.

:FETCh[:SCALAr]:CURRent:HIGH → Query

Description Returns the read output current maximum peak value (Imax).

Note: Current maximum peak value is defined as the highest peak value in the complete period.

Query syntax :FETCh[:SCALAr]:CURRent:HIGH?

Return parameter <NR2> Returns the read Imax value in amps.

:FETCh[:SCALAr]:CURRent:LOW → Query

Description Returns the read output current minimum value (Imin).

Note: Current minimum value is defined as the lowest value in the complete period.

Query syntax :FETCh[:SCALAr]:CURRent:LOW?

Return parameter <NR2> Returns the read Imin value in amps.

:FETCh[:SCALAr]:CURRent:PEAK:HOLD → Query

Description Returns the read output current peak hold value in amps (IPK Hold).

Query syntax :FETCh[:SCALAr]:CURRent:PEAK:HOLD?

Return <NR2> Returns the read peak hold value in amps.

:FETCh[:SCALar]:CURRent[:RMS] → Query

Description	Returns the read output current (Irms).
Query syntax	:FETCh[:SCALar]:CURRent[:RMS]?
Return	<NR2> Returns the read current value in Irms.

:FETCh[:SCALar]:CURRent[:RMS]:TOTal → Query

Description	Returns the read total of output current (Irms).
Query syntax	:FETCh[:SCALar]:CURRent[:RMS]:TOTal?
Return	<NR2> Returns the read total of current value in Irms.

:FETCh[:SCALar]:CURRent:AC → Query

Description	Returns the read output AC current (Irms).
Query syntax	:FETCh[:SCALar]:CURRent:AC?
Return	<NR2> Returns the read AC current value in Irms.

:FETCh[:SCALar]:CURRent:AVERAge → Query

Description	Returns the read current average value (Iavg).
Query syntax	:FETCh[:SCALar]:CURRent:AVERAge?
Return	<NR2> Returns the read current average value in amps.

:FETCh[:SCALar]:CURRent:HARMonic[:RMS] → Query

Description	Returns read 101 values covering Total and order 1 to 100 current (Irms) in harmonic. (Only AC-INT and 50 / 60 Hz Active)
Query syntax	:FETCh[:SCALar]:CURRent:HARMonic[:RMS]?

Return	<code><NR2>,<NR2 >,<NR2>,<NR2>..., etc.</code>	Returns the read entire 101 values containing Total and order 1 to 100 current (Irms) in harmonic.
--------	--	--

:FETCh[:SCALar]:CURRent:HARMonic:RATio → **Query**

Description	Returns read 101 values covering Total and order 1 to 100 current (Ratio) in harmonic. (Only AC-INT and 50 /60 Hz Active)
-------------	---

Query syntax	<code>:FETCh[:SCALar]:CURRent:HARMonic:RATio?</code>
--------------	--

Return	<code><NR2>,<NR2 >,<NR2>,<NR2>..., etc.</code>	Returns the read entire 101 values containing Total and order 1 to 100 current (Ratio) in harmonic.
--------	--	---

:FETCh[:SCALar]:FREQuency → **Query**

Description	Returns the read SYNC signal source frequency in Hz. The external sync signal frequency measurement range is 10.0 Hz to 2100.0 Hz. (Only AC+DC-sync or AC-sync Active)
-------------	--

Query syntax	<code>:FETCh[:SCALar]:FREQuency?</code>
--------------	---

Return	<code><NR2></code>	Returns the read SYNC frequency in Hz.
--------	--------------------------	--

:FETCh[:SCALar]:LINE:VOLTage[:RMS] → **Query**

Description	Returns the read line voltage (Vrms).
-------------	---------------------------------------

Syntax	<code>:FETCh[:SCALar]:LINE:VOLTage[:RMS]?</code>
--------	--

Return	<code><NR2></code>	Returns the read line voltage value in Vrms.
--------	--------------------------	--

:FETCh[:SCALar]:LINE:VOLTage:AVERage → **Query**

Description	Returns the read line voltage average value (Vavg).
-------------	---

Syntax	<code>:FETCh[:SCALar]:LINE:VOLTage:AVERage?</code>
--------	--

Return	<code><NR2></code>	Returns the read line voltage average value in volts.
--------	--------------------------	---

:FETCh[:SCALar]:LINE:VOLTage:HIGH → Query

Description Returns the read output line voltage maximum peak value (Vmax).

Note: Line voltage maximum peak value is defined as the highest peak value in the complete period.

Query syntax :FETCh[:SCALar]:LINE:VOLTage:HIGH?

Return parameter <NR2> Returns the read line Vmax value in volts.

:FETCh[:SCALar]:LINE:VOLTage:LOW → Query

Description Returns the output read line voltage minimum value (Vmin).

Note: Line voltage minimum value is defined as the lowest value in the complete period.

Query syntax :FETCh[:SCALar]:VOLTage:LOW?

Return parameter <NR2> Returns the read line Vmin value in volts.

:FETCh[:SCALar]:POWer[:AC]:APParent Set →

Description Returns the read apparent power (S).

Query syntax :FETCh[:SCALar]:POWer[:AC]:APParent?

Return <NR2> Returns the read apparent power in VA.

:FETCh[:SCALar]:POWer[:AC]:APParent:TOTal → Query

Description Returns the read total of apparent power (S).

Query syntax :FETCh[:SCALar]:POWer[:AC]:APParent:TOTal?

Return <NR2> Returns the read total of apparent power in VA.

:FETCh[:SCALar]:POWer[:AC]:PFAcTOr → **Query**

Description	Returns the read power factor (PF).
Query syntax	:FETCh[:SCALar]:POWer[:AC]:PFAcTOr?
Return	<NR2> Returns the read power factor.

:FETCh[:SCALar]:POWer[:AC]:PFAcTOr:TOTal → **Query**

Description	Returns the read total of power factor (PF).
Query syntax	:FETCh[:SCALar]:POWer[:AC]:PFAcTOr:TOTal?
Return	<NR2> Returns the read total of power factor.

:FETCh[:SCALar]:POWer[:AC]:REACTive → **Query**

Description	Returns the read reactive power (Q).
Query syntax	:FETCh[:SCALar]:POWer[:AC]:REACTive?
Return	<NR2> Returns the read reactive power in VAR.

:FETCh[:SCALar]:POWer[:AC]:REACTive:TOTal → **Query**

Description	Returns the read total of reactive power (Q).
Query syntax	:FETCh[:SCALar]:POWer[:AC]:REACTive:TOTal?
Return	<NR2> Returns the read total of reactive power in VAR.

:FETCh[:SCALar]:POWer[:AC][:REAL] → **Query**

Description	Returns the read active power in Watts (P).
Query syntax	:FETCh[:SCALar]:POWer[:AC][:REAL]?
Return	<NR2> Returns the read power in Watts.

:FETCh[:SCALar]:POWer[:AC][:REAL]:TOTal → **Query**

Description Returns the read total of active power in Watts (P).

Query syntax :FETCh[:SCALar]:POWer[:AC][:REAL]:TOTal?

Return <NR2> Returns the read total of power in Watts.

:FETCh[:SCALar]:VOLTage[:RMS] → **Query**

Description Returns the read voltage (Vrms).

Query syntax :FETCh[:SCALar]:VOLTage[:RMS]?

Return <NR2> Returns the read voltage value in Vrms.

:FETCh[:SCALar]:VOLTage[:RMS]:TOTal → **Query**

Description Returns the read total of voltage (Vrms).

Query syntax :FETCh[:SCALar]:VOLTage[:RMS]:TOTal?

Return <NR2> Returns the read total of voltage value in Vrms.

:FETCh[:SCALar]:VOLTage:AC → **Query**

Description Returns the read AC voltage (Vrms).

Query syntax :FETCh[:SCALar]:VOLTage:AC?

Return <NR2> Returns the read AC voltage value in Vrms.

:FETCh[:SCALar]:VOLTage:AVERage → **Query**

Description Returns the read voltage average value (Vavg).

Query syntax :FETCh[:SCALar]:VOLTage:AVERage?

Return <NR2> Returns the read voltage average value in volts.

:FETCh[:SCALAr]:VOLTage:HIGH → **Query**

Description Returns the read output voltage maximum peak value (Vmax).

Note: Voltage maximum peak value is defined as the highest peak value in the complete period.

Query syntax :FETCh[:SCALAr]:VOLTage:HIGH?

Return parameter <NR2> Returns the read Vmax value in volts.

:FETCh[:SCALAr]:VOLTage:LOW → **Query**

Description Returns the read output voltage minimum value (Vmin).

Note: Voltage minimum value is defined as the lowest value in the complete period.

Query syntax :FETCh[:SCALAr]:VOLTage:LOW?

Return parameter <NR2> Returns the read Vmin value in volts.

:FETCh[:SCALAr]: VOLTage:HARMonic[:RMS] → **Query**

Description Returns read 101 values covering Total and order 1 to 100 voltage (Vrms) in harmonic. (Only AC-INT and 50 /60 Hz Active)

Query syntax :FETCh[:SCALAr]: VOLTage:HARMonic[:RMS]?

Return <NR2>,<NR2 >,<NR2>,<NR2>..., etc. Returns the read entire 101 values containing Total and order 1 to 100 voltage (Vrms) in harmonic.

:FETCh[:SCALar]: VOLTage:HARMonic:RATio → Query

Description	Returns the read 101 values covering Total and order 1 to 100 voltage (Ratio) in harmonic. (Only AC-INT and 50 /60 Hz Active)
Query syntax	:FETCh[:SCALar]: VOLTage:HARMonic:RATio?
Return	<NR2>,<NR2>,<NR2>,<NR2>,<NR2>..., etc. Returns the read entire 101 values containing Total and order 1 to 100 voltage (Ratio) in harmonic.

Memory Commands

:MEMory:RCL.....	84
:MEMory:SAV.....	84

:MEMory:RCL



Description Recalls the settings from memory slot M0~M9. These memory slots are mapped to the preset settings. Equivalent to the *RCL command.

Syntax :MEMory:RCL {<NR1>|MINimum|MAXimum}

Parameter	<NR1>	0~9
	MINimum	0
	MAXimum	9

Example :MEMory:RCL
 Recall the settings from M1.

:MEMory:SAV



Description Saves the settings into memory slot M0 ~ M9. These memory slots are mapped to the preset settings. Equivalent to the *SAV command.

Syntax :MEMory:SAV {<NR1>|MINimum|MAXimum}

Parameter	<NR1>	0~9
	MINimum	0
	MAXimum	9

Example :MEMory:SAV 1
 Save the settings to M1.

Output Commands

:OUTPut:IMPedance.....	85
:OUTPut:IMPedance:INDuctance	85
:OUTPut:IMPedance:RESistance	86
:OUTPut:MONitor:AMPLitude.....	87
:OUTPut:MONitor:SOURce<1 2>.....	87
:OUTPut[:STATe]	88
:OUTPut:PON	88
:OUTPut:PROTection:CLEar	89
:OUTPut:RELAY	89

:OUTPut:IMPedance (Set) →
→ (Query)

Description	Sets or queries the output impedance state of power source.	
Syntax	:OUTPut:IMPedance {<bool> OFF ON}	
Query Syntax	:OUTPut:IMPedance?	
Parameter	OFF 0	Turns the output impedance off.
	ON 1	Turns the output impedance on.
Return parameter	<bool>	Returns output impedance status of the instrument.
Example	:OUTP:IMP 0 Sets power output impedance off.	

:OUTPut:IMPedance:INDuctance (Set) →
→ (Query)

Description	Sets or queries the phase and inductance value parameter for output impedance inductance.	
Syntax	:OUTPut:IMPedance:INDuctance <NR1> L1 L2 L3 ALL,<NR2> MINimum MAXimum	
Query Syntax	:OUTPut:IMPedance:INDuctance?	
Parameter	<phase>, L1 0	L1 phase
	<NR1> L2 1	L2 phase

Parameter	<inductance >, <NR2>	L3 2 ALL 3 inductance	L3 phase All phase 0.0 ~ 2000μH
Minimum inductance	0.0		
Maximum inductance	2000		
Return parameter	<phase>,<i nductance>		Returns the phase and inductance value parameter for output impedance inductance.
Example	:OUTP:IMP:IND? ALL +0.1,+0.1,+0.1 Returns the phase and inductance value parameter for output impedance inductance.		

:OUTPut:IMPedance:RESistance (Set) →
→ (Query)

Description	Sets or queries the phase and inductance value parameter for output impedance resistance.		
Syntax	:OUTPut:IMPedance:RESistance <NR1> L1 L2 L3 ALL,<NR2> MINimum MAXimum		
Query Syntax	:OUTPut:IMPedance:RESistance?		
Parameter	<phase>, <NR1>	L1 0 L2 1 L3 2 ALL 3	L1 phase L2 phase L3 phase All phase
Parameter	<resistance> , <NR2>	resistanc	0.0 ~ 1Ω
Minimum resistance	0.0		
Maximum resistance	1		
Return parameter	<phase>,<cr esistance>		Returns the phase and resistance value parameter for output impedance resistance.

Example :OUTP:IMP:RES? ALL
 0.1,+0.1,+0.1
 Returns the phase and resistance value parameter for
 output impedance resistance.

Set →

→ Query

:OUTPut:MONitor:AMPLitude

Description Sets or queries the range for output monitor
 amplitude.

Syntax :OUTPut:MONitor:AMPLitude {<NR1>|LOW|HIGH}

Query Syntax :OUTPut:MONitor:AMPLitude?

Parameter / <NR1> From 0 – 1, which represent different amplitude
 Return Parameter ranges, respectively.
 LOW | 0 ±2.5
 HIGH | 1 ±10

Example :OUTP:MON:AMPL HIGH
 Sets the amplitude range to high.

Set →

→ Query

:OUTPut:MONitor:SOURce<1|2>

Description Sets or queries the source for monitor output1 or
 monitor output2 . (For single-phase, only L1 can be set.
 For single-phase three-wire, L1 and L2,can be set.)

Syntax :OUTPut:MONitor:SOURce<1|2> L1Voltage|
 L2Voltage| L3Voltage| L1Current|L2Current|L3Current

Query Syntax :OUTPut:MONitor:SOURce<1|2>?

Parameter <1|2> Output 1 or Output 2
 L1Voltage | L1 phase voltage
 L2Voltage | L2 phase voltage
 L3Voltage | L3phase voltage
 L1Current | L1 phase current
 L2Current | L2 phase current
 L3Current | L3 phase current

Example :OUTP:MON:SOUR1 L2Voltage
 Sets the monitor source1 L2 phase voltage.



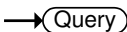

:OUTPut[:STATe]

Description	Sets or queries the output state of power source.	
Syntax	:OUTPut[:STATe] {<bool> OFF ON}	
Query Syntax	:OUTPut[:STATe]?	
Parameter	OFF 0	Turns the output off.
	ON 1	Turns the output on.
Return parameter	<bool>	Returns output status of the instrument.
Example	:OUTP 0 Sets power output off.	



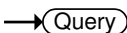

:OUTPut:PON

Description	Sets the output state at power-on.	
Syntax	:OUTPut:PON {<NR1> OFF ON SEQ SIM}	
Return Syntax	:OUTPut:PON?	
Parameter	<NR1>	0 ~ 3
	OFF 0	Disabled
	ON 1	Enabled
	SEQ 2	Sequence function
	SIM 3	Simulate function
Return parameter	<NR1>	Returns the selected output state at power-on from 0 to 3.
Example	:OUTPut:PON 2 Sets sequence function on at power-on.	

:OUTPut:PROTection:CLEar (Set) →

Description The Command will clear alarms like Over Current, Over Peak Current, Output Over-Power, Output Short, Output Overvoltage, Sensing Voltage Error.

Syntax :OUTPut:PROTection:CLEar

(Set) →

:OUTPut:RELAy → (Query)

Description Sets or queries the output relay of power source.

Syntax :OUTPut:RELAy {<bool>|OFF|ON}

Query Syntax :OUTPut:RELAy?

Parameter	OFF 0	Turns the output relay Disable.
	ON 1	Turns the output relay Enable.

Return parameter <bool> Returns output relay of the instrument.

Example :OUTP:REL 1
Sets output relay Enable.

Status Commands

:STATus:OPERation:CONDition.....	90
:STATus:OPERation:ENABle	90
:STATus:OPERation[:EVENT]	91
:STATus:OPERation:NTRansition	91
:STATus:OPERation:PTRansition	91
:STATus:QUEStionable[:EVENT].....	92
:STATus:QUEStionable:CONDition.....	92
:STATus:QUEStionable:ENABle	92
:STATus:QUEStionable:NTRansition.....	92
:STATus:QUEStionable:PTRansition.....	93
:STATus:PRESet.....	93
:STATus:WARNIing:CONDition	94
:STATus:WARNIing:ENABle	94
:STATus:WARNIing[:EVENT]	94
:STATus:WARNIing:NTRansition	95
:STATus:WARNIing:PTRansition	95
:STATus:LOCK:CONDition	95
:STATus:LOCK:ENABle.....	95
:STATus:LOCK[:EVENT]	96
:STATus:LOCK:NTRansition	96
:STATus:LOCK:PTRansition	96

:STATus:OPERation:CONDition → Query

Description Queries the Operation Status register. This query will not clear the register.

Syntax :STATus:OPERation:CONDition?

Return <NR1> Returns the bit sum of the Operation Condition register. (0~32767)

Set →

:STATus:OPERation:ENABle → Query

Description Sets or queries the bit sum of the Operation Status Enable register.

Syntax :STATus:OPERation:ENABLE <NR1>

Query Syntax :STATus:OPERation:ENABLE?

Parameter <NR1> 0~32767

Return parameter <NR1> 0~32767

:STATus:OPERation[:EVENT] → Query

Description Queries the Operation Status Event register and clears the contents of the register.

Syntax :STATus:OPERation[:EVENT]?

Return <NR1> Returns the bit sum of the Operation Status Event register.

Set →

:STATus:OPERation:NTRansition → Query

Description Sets or queries the bit sum of the negative transition filter of the Operation Status register.

Syntax :STATus:OPERation: NTRansition <NR1>

Query Syntax :STATus:OPERation:NTRansition?

Parameter <NR1> 0~32767

Return parameter <NR1> 0~32767

Set →

:STATus:OPERation:PTRansition → Query

Description Sets or queries the bit sum of the positive transition filter of the Operation Status register.

Syntax :STATus:OPERation:PTRansition <NR1>

:STATus:OPERation:PTRansition?

Parameter <NR1> 0~32767

Return parameter <NR1> 0~32767

:STATus:QUESTionable[:EVENT] → Query

Description Queries the bit sum of the Questionable Status Event register. This query will also clear the contents of the register.

Query Syntax :STATus:QUESTionable[:EVENT]?

Return parameter <NR1> 0~32767

:STATus:QUESTionable:CONDition → Query

Description Queries the status (bit sum) of the Questionable Status register. This query will not clear the register.

Query Syntax :STATus:QUESTionable:CONDition?

Return parameter <NR1> 0~32767

:STATus:QUESTionable:ENABLE → Query

Description Sets or queries the bit sum of the Questionable Status Enable register.

Syntax :STATus:QUESTionable:ENABLE <NR1>

Query Syntax :STATus:QUESTionable:ENABLE?

Parameter <NR1> 0~32767

Return parameter <NR1> 0~32767

:STATus:QUESTionable:NTRansition → Query

Description Sets or queries the bit sum of the negative transition filter of the Questionable Status register.

Syntax :STATus:QUESTionable:NTRansition <NR1>

Query Syntax :STATus:QUESTionable:NTRansition?

Parameter <NR1> 0~32767

Return parameter <NR1> 0~32767

:STATus:QUEStionable:PTRansition (Set) →
→ (Query)

Description Sets or queries the bit sum of the positive transition filter of the Questionable Status register.

Syntax :STATus:QUEStionable:PTRansition <NR1>

Return Syntax :STATus:QUEStionable:PTRansition?

Parameter <NR1> 0~32767

Return parameter <NR1> 0~32767

:STATus:PRESet (Set) →

Description This command resets the ENABLE register, the PTRansition filter and NTRansition filter on the Operation Status, Questionable Status, Warning Status and System Lock Status Registers. The registers/filters will be reset to a default value.

Default Register/Filter Values	Setting
QUEStionable Status Enable	0x0000
QUEStionable Status Positive Transition	0x7FFF
QUEStionable Status Negative Transition	0x0000
Operation Status Enable	0x0000
Operation Status Positive Transition	0x7FFF
Operation Status Negative Transition	0x0000
WARning Status Enable	0x0000
WARning Status Positive Transition	0x7FFF
WARning Status Negative Transition	0x0000
System Lock Status Enable	0x0000
System Lock Status Positive Transition	0x7FFF
System Lock Status Negative Transition	0x0000

Summary: The Questionable Status Enable registers, the Operation Status Enable registers, Warning Status registers and System Lock Status registers are both reset to 0.

The Questionable Status, Operation Status, Warning Status and System Lock Status Positive Transition filters are all set high (0x7FFF) and the Negative Transition filters are all set low (0x0000). I.e., only positive transitions will be recognized for the Questionable Status, Operation Status, Warning Status and System Lock Status registers.

Syntax :STATus:PRESet

:STATus:WARnIng:CONDition → Query

Description Queries the Warning Status register. This query will not clear the register.

Syntax :STATus:WARnIng:CONDition?

Return <NR1> Returns the bit sum of the Warning Condition register. (0~32767)

:STATus:WARnIng:ENABle

Set →

→ Query

Description Sets or queries the bit sum of the Warning Status Enable register.

Syntax :STATus:WARnIng:ENABle <NR1>

Query Syntax :STATus:WARnIng:ENABle?

Parameter <NR1> 0~32767

Return parameter <NR1> 0~32767

:STATus:WARnIng[:EVENT] → Query

Description Queries the Warning Status Event register and clears the contents of the register.

Syntax :STATus:WARnIng[:EVENT]?

Return <NR1> Returns the bit sum of the Warning Status Event register.

:STATus:WARNing:NTRansition  

Description Sets or queries the bit sum of the negative transition filter of the Warning Status register.

Syntax :STATus:WARNing:NTRansition <NR1>

Query Syntax :STATus:WARNing:NTRansition?

Parameter <NR1> 0~32767

Return parameter <NR1> 0~32767

:STATus:WARNing:PTRansition  

Description Sets or queries the bit sum of the positive transition filter of the Warning Status register.

Syntax :STATus:WARNing:PTRansition <NR1>

:STATus:WARNing:PTRansition?

Parameter <NR1> 0~32767

Return parameter <NR1> 0~32767

:STATus:LOCK:CONDition 

Description Queries the System Lock Status register. This query will not clear the register.

Syntax :STATus:LOCK:CONDition?

Return <NR1> Returns the bit sum of the System Lock Status register. (0~32767)

:STATus:LOCK:ENABLE  

Description Sets or queries the bit sum of the System Lock Status Enable register.

Syntax :STATus:LOCK:ENABLE <NR1>

Query Syntax :STATus:LOCK:ENABLE?

Parameter <NR1> 0~32767
 Return parameter <NR1> 0~32767

:STATus:LOCK[:EVENT] → Query

Description Queries the System Lock Status Event register and clears the contents of the register.

Syntax :STATus:LOCK [:EVENT]?

Return <NR1> Returns the bit sum of the System Lock Status Event register.

Set →

:STATus:LOCK:NTRansition → Query

Description Sets or queries the bit sum of the negative transition filter of the System Lock Status register.

Syntax :STATus:LOCK:NTRansition <NR1>

Query Syntax :STATus:LOCK:NTRansition?

Parameter <NR1> 0~32767

Return parameter <NR1> 0~32767

Set →

:STATus:LOCK:PTRansition → Query

Description Sets or queries the bit sum of the positive transition filter of the System Lock Status register.

Syntax :STATus:LOCK:PTRansition <NR1>

:STATus:LOCK:PTRansition?

Parameter <NR1> 0~32767

Return parameter <NR1> 0~32767

System Function Commands

:SYSTem:ARBITrary:EDIT:BUILtin	98
:SYSTem:ARBITrary:EDIT:SURGe	99
:SYSTem:ARBITrary:EDIT:STAir	99
:SYSTem:ARBITrary:EDIT:CFACtor2.....	100
:SYSTem:ARBITrary:EDIT:CFACtor1.....	100
:SYSTem:ARBITrary:EDIT:CLIP	101
:SYSTem:ARBITrary:EDIT:STORe.....	101
:SYSTem:ARBITrary:EDIT:TRlangle.....	102
:SYSTem:ARBITrary:EDIT:DIP	103
:SYSTem:ARBITrary:EDIT:LFRing	104
:SYSTem:ARBITrary:EDIT:RIPple	106
:SYSTem:ARBITrary:EDIT:STORe:APPLy<1 3> ..	107
:SYSTem:BEEPer:STATe	108
:SYSTem:COMMunicate:INTerface:ADDReSS.....	108
:SYSTem:COMMunicate:INTerface:BAUD.....	108
:SYSTem:COMMunicate:LAN:DHCP	109
:SYSTem:COMMunicate:LAN:DNS	109
:SYSTem:COMMunicate:LAN:GATeway	109
:SYSTem:COMMunicate:LAN:IPADdress.....	110
:SYSTem:COMMunicate:LAN:MAC	110
:SYSTem:COMMunicate:LAN:SMASK	110
:SYSTem:COMMunicate:RLState	111
:SYSTem:COMMunicate:SERial[:RECeive]	
:TRANsmit:BAUD	112
:SYSTem:COMMunicate:SERial[:RECeive]	
:TRANsmit:BITS	112
:SYSTem:COMMunicate:SERial[:RECeive]	
:TRANsmit:PARity	113
:SYSTem:COMMunicate:SERial[:RECeive]	
:TRANsmit:SBITs	114
:SYSTem:COMMunicate:TCPip:CONTRol	114
:SYSTem:COMMunicate:USB:FRONT:STATe	115
:SYSTem:COMMunicate:USB:REAR:STATe	115
:SYSTem:CONFigure[:MODE].....	115
:SYSTem:CONFigure:EXTio[:STATe].....	116
:SYSTem:CONFigure:TRIGger:OUTPut:SOURce ..	116

:SYSTem:CONFigure:TRIGger:OUTPut:WIDTh ..117
 :SYSTem:ERRor 117
 :SYSTem:ERRor:ENABle..... 117
 :SYSTem:HOLD:STATe..... 118
 :SYSTem:PKHold:TIME..... 118
 :SYSTem:KLOCK 118
 :SYSTem:REBoot 119
 :SYSTem:VUNit..... 119

:SYSTem:ARBitrary:EDIT:BUILtin



Description	Sets or queries the built in function of arbitrary edit	
Syntax	:SYSTem:ARBitrary:EDIT:BUILtin TRlangle STAir	
Query Syntax	CLIP CFACtor1 CFACtor2 SURGe DST<01 22> RIPple DIP LFRing :SYSTem:ARBitrary:EDIT:BUILtin?	
Parameter/Return	TRlangle	Built In Triangle Wave Function
	STAir	Built In Stair Wave Function
	CLIP	Built In Clip Wave Function
	CFACtor1	Built In CF-1 Wave Function
	CFACtor2	Built In CF-2 Wave Function
	SURGe	Built In Surge Wave Function
	DST<01 22>	Built In DST01 ~ DST22 Wave Function
	RIPple	Built In DC Ripple Wave Function
	DIP	Built In DIP Wave Function.
	LFRing	Built In LFRing Wave Function.
Example	:SYST:ARB:EDIT:BUIL? TRI Returns the built in function of arbitrary edit	

:SYSTem:ARBitrary:EDIT:SURGe



Description	Sets or queries the type and ACV and site parameter for built in Surge wave function	
Syntax	:SYSTem:ARBitrary:EDIT:SURGe <NR1> SQU SIN, <NR1> MINimum MAXimum, <NR1> MINimum MAXimum	
Query Syntax	:SYSTem:ARBitrary:EDIT:SURGe?	
Parameter<Type>	SQU 0 SIN 1	Square waveform type Sine waveform type
Parameter<ACV>	<NR1> MINimum MAXimum	ACV Ratio : 0 ~100(0 ~ 100%) Minimum ACV Ratio : 0 (0%) Maximum ACV Ratio : 100 (100%)
Parameter<Site>	<NR1> MINimum MAXimum	Site Ratio : 0 ~100(0 ~ 100%) Minimum Site Ratio : 0 (0%) Maximum Site Ratio : 100 (100%)
Return parameter	<Type>,<ACV> >,<Site>	Returns the type and ACV and site parameter for built in Surge wave function

Example :SYST:ARB:EDIT:SURG?
SIN,+50,+25
Returns the type and ACV and site parameter for built in Surge wave function

:SYSTem:ARBitrary:EDIT:STAir



Description	Sets or queries the stair parameter for built in stair wave function	
Syntax	:SYSTem:ARBitrary:EDIT:STAir <NR1> MINimum MAXimu	
Query Syntax	:SYSTem:ARBitrary:EDIT:STAir? [MINimum MAXimum]?	
Parameter	<NR1> MINimum MAXimum	stair : 1 ~ 100 Minimum stair : 1 Maximum stair : 100
Return parameter	<NR1>	Returns the stair parameter for built in stair wave function

Example :SYST:ARB:EDIT:STA?
 +5
 Returns the stair parameter for built in stair wave function

Set →

:SYSTem:ARBitrary:EDIT:CFACtor2 → Query

Description Sets or queries the crest factor parameter for built in CF-2 wave function

Syntax :SYSTem:ARBitrary:EDIT:CFACtor2 <NR2> | MINimum | MAXimum

Query Syntax :SYSTem:ARBitrary:EDIT:CFACtor2? [MINimum | MAXimum]?

Parameter	<NR2>	crest factor : 1.5 ~ 2.0
	MINimum	Minimum crest factor : 1.5
	MAXimum	Maximum crest factor : 2.0
Return parameter	<NR2>	Returns the crest factor parameter for built in CF-2 wave function

Example :SYST:ARB:EDIT:CFAC2?
 +1.5000
 Returns the crest factor parameter for built in CF-2 wave function

Set →

:SYSTem:ARBitrary:EDIT:CFACtor1 → Query

Description Sets or queries the crest factor parameter for built in CF-1 wave function

Syntax :SYSTem:ARBitrary:EDIT:CFACtor1 <NR2> | MINimum | MAXimum

Query Syntax :SYSTem:ARBitrary:EDIT:CFACtor1? [MINimum | MAXimum]?

Parameter	<NR2>	crest factor : 1.1 ~ 10.0
	MINimum	Minimum crest factor : 1.1
	MAXimum	Maximum crest factor : 10.0
Return parameter	<NR2>	Returns the crest factor parameter for built in CF-1 wave function

Example :SYST:ARB:EDIT:CFAC1?
 +2.0000
 Returns the crest factor parameter for built in CF-1
 wave function

Set →
 → Query

Description	Sets or queries the ratio parameter for built in clip wave function	
Syntax	:SYSTem:ARBItrary:EDIT:CLIP <NR2> MINimum	
Query Syntax	MAXimum	
	:SYSTem:ARBItrary:EDIT:CLIP? [MINimum	
	MAXimum]?	
Parameter	<NR2>	clip ratio : 0.00 ~ 1.00
	MINimum	Minimum clip ratio : 0.00
	MAXimum	Maximum clip ratio : 1.00
Return parameter	<NR2>	Returns the ratio parameter for built in clip wave function

Example :SYST:ARB:EDIT:CLIP?
 +0.5000
 Returns the ratio parameter for built in clip wave
 function

:SYSTem:ARBItrary:EDIT:STORE Set →

Description	Saves the waveform data of built in into ARB1 ~ ARB253	
Syntax	:SYSTem:ARBItrary:EDIT:STORE <NR1> ARB1 ARB2 ARB3 ARB4 ... ARB250 ARB251 ARB252 ARB253	
Parameter	ARB1 1	Saves the waveform data of built in into ARB1
	ARB2 2	Saves the waveform data of built in into ARB2
	ARB3 3	Saves the waveform data of built in into ARB3
	ARB4 4	Saves the waveform data of built in into ARB4
		•
		•
		•

ARB250 | 250 Saves the waveform data of built in into ARB250
 ARB251 | 251 Saves the waveform data of built in into ARB251
 ARB252 | 252 Saves the waveform data of built in into ARB252
 ARB253 | 253 Saves the waveform data of built in into ARB253

Example :SYST:ARB:EDIT:STOR ARB1
 Saves the waveform data of built in into ARB1

:SYSTem:ARBItary:EDIT:TRlangle  

Description Sets or queries the symmetry parameter for built in triangle wave function

Syntax :SYSTem:ARBItary:EDIT:TRlangle <NR1> | MINimum
 | MAXimum

Query Syntax :SYSTem:ARBItary:EDIT:TRlangle? [MINimum |
 MAXimum]?

Parameter	<NR1> MINimum MAXimum	Symmetry : 0 ~ 100(0 ~ 100%) Minimum Symmetry : 0 (0%) Maximum Symmetry : 100 (100%)
-----------	-----------------------------	--

Return parameter	<NR1>	Returns the symmetry parameter for built in triangle wave function
------------------	-------	--

Example :SYST:ARB:EDIT:TRI?
 +50
 Returns the symmetry parameter for built in triangle wave function

Set →

→ Query

:SYSTem:ARBitrary:EDIT:DIP

Description	Sets or queries the ST Phs and SP Phs and End Phs parameter for built in DIP wave function.	
Syntax	:SYSTem:ARBitrary:EDIT:DIP <NR2> MINimum MAXimum, <NR2> MINimum MAXimum, <NR2> MINimum MAXimum	
Query Syntax	:SYSTem:ARBitrary:EDIT:DIP? [MINimum MAXimum]	
Parameter< ST Phs >	<NR2>	0.1 ~ (SP Phs - 0.1)
	MINimum	0.1
	MAXimum	(SP Phs - 0.1)
Parameter< SP Phs >	<NR2>	(ST Phs+ 0.1) ~ (End Phs - 0.1)
	MINimum	(ST Phs+ 0.1)
	MAXimum	(End Phs - 0.1)
Parameter< End Phs >	<NR2>	(SP Phs+ 0.1) ~ 359.9
	MINimum	(SP Phs+ 0.1)
	MAXimum	359.9
Return parameter	< ST Phs(NR2) >, < SP Phs(NR2) >, < End Phs(NR2) >	Returns the ST Phs and SP Phs and End Phs parameter for built in DIP wave function
Example	:SYSTem:ARBitrary:EDIT:DIP? 45.0,54.0,172.0 Returns the ST Phs and SP Phs and End Phs parameter for built in DIP wave function	

Parameter< End Phs >	MAXimum	(End Phs - 0.1)
	<NR2>	(ST Phs+ 0.1) ~ 359.9
Parameter< Ring Phs >	MINimum	(ST Phs+ 0.1)
	MAXimum	359.9
Parameter< Ring Phs >	<NR2>	0.1 ~ 359.9
	MINimum	0.1
Return parameter	MAXimum	359.9
	< ACV(NR2) >, < Amp(NR1) >, < Base_F(NR2) >, < Ring_F(NR2) >, < Decay(NR2) >, < ST Phs(NR2) >, < End Phs(NR2) >, < Ring Phs(NR2) >	Returns the ACV and Amp and Base_F and Ring_F and Decay and ST Phs and End Phs and Ring Phs parameter for built in LFRing wave function

Example :SYSTEM:ARbitrary:EDIT:LFRing
 0.0,+140,50.0,200.0,0.005,60.0,120.0,30.0
 Returns the ACV and Amp and Base_F and Ring_F and Decay and ST Phs and End Phs and Ring Phs parameter for built in LFRing wave function

Set →

← Query

:SYSTem:ARBitrary:EDIT:RIPPlE

Description	Sets or queries the Times and VDC and Level parameter for built in DC Ripple wave function	
Syntax	:SYSTem:ARBitrary:EDIT:RIPPlE <NR1> MINimum MAXimum,<NR1> MINimum MAXimum, <NR1> MINimum MAXimum	
Query Syntax	:SYSTem:ARBitrary:EDIT:RIPPlE?	
Parameter <Times>	<NR1>	Times : 1 2 3 6
	MINimum	MINimum Times : 1
	MAXimum	MAXimum Times : 6
Parameter <VDC>	<NR1>	VDC Value : 1 ~ 100
	MINimum	MINimum VDC Value : 1
	MAXimum	MAXimum VDC Value : 100
Parameter <Level>	<NR1>	Level Ratio : 1 ~ 30(1 ~ 30%)
	MINimum	MINimum Level Ratio : 1(1%)
	MAXimum	MAXimum Level Ratio : 30(30%)
Return parameter	<Times>, <VDC>, <Level>	Returns the Times and VDC and Level parameter for built in DC Ripple wave function
Example	:SYST:ARB:EDIT:RIPP? 1,+48,+15 Returns the Times and VDC and Level parameter for built in DC Ripple wave function	

:SYSTem:ARBitary:EDIT:STORe:APPLy<1|3> Set →

Description Saves the waveform to L1 or L2 or L3 phase(into ARB1 ~ ARB253)/Output Mode/ACV/DCV/VPK+ Limit/VPK-Limit/V Unit(TRI, ARB) data(for Built in is RIPPLE)

 Saves the waveform to L1 or L2 or L3 phase(into ARB1 ~ ARB253)/Output Mode/ACV/DCV/VPK+ Limit/VPK-Limit/V Unit(TRI, ARB)/Freq/Freq Hi Limit/Freq Lo Limit data(for Built in is LFRing)

 For single-phase, only L1 can be set. For single-phase three-wire, L1 and L2,can be set.

 If instrument edit setting all,apply all phase.

Syntax :SYSTem:ARBitary:EDIT:STORe:APPLy<1|3> <NR1> |ARB1|ARB2|ARB3|ARB4|...|ARB250|ARB251|ARB252|ARB253

Parameter	ARB1 1	Saves the waveform data of built in into ARB1
	ARB2 2	Saves the waveform data of built in into ARB2
	ARB3 3	Saves the waveform data of built in into ARB3
	ARB4 4	Saves the waveform data of built in into ARB4
		•
		•
		•
	ARB250 250	Saves the waveform data of built in into ARB250
	ARB251 251	Saves the waveform data of built in into ARB251
	ARB252 252	Saves the waveform data of built in into ARB252
	ARB253 253	Saves the waveform data of built in into ARB253

Example :SYST:ARB:EDIT:STOR:APPL1 ARB2

 Saves the waveform(into ARB2) and Output Mode(AC+DC-INT) / ACV / DCV / VPK+ Limit(max) / VPK- Limit(min) / V Unit(TRI, ARB)(p-p) data(for Built in is RIPPLE)

 Saves the waveform(into ARB2) and Output Mode(AC+DC-INT) / ACV / DCV / VPK+ Limit(max) / VPK- Limit(min) / V Unit(TRI, ARB)(p-p)/Freq/Freq Hi Limit(max)/Freq Lo Limit(min) data(for Built in is LFRing)

 →
 → 

:SYSTem:BEEPer:STATe

Description	Sets or queries the buzzer state on/off.	
Syntax	:SYSTem:BEEPer:STATe {<bool> OFF ON}	
Query Syntax	:SYSTem:BEEPer:STATe?	
Parameter	OFF 0	Turns the buzzer off.
	ON 1	Turns the buzzer on.
Return parameter	<bool>	Returns the buzzer status.

 →
 → 

:SYSTem:COMMunicate:INTerface:ADDRess

Description	Sets or queries the GPIB address or CAN Node ID or DeviceNet MAC ID.	
-------------	--	--

 **Note** Depends on Option interface device. The setting will only be valid after the power has been cycled.

Syntax	:SYSTem:COMMunicate:INTerface:ADDRess <NR1>	
Query Syntax	:SYSTem:COMMunicate:INTerface:ADDRess?	
Parameter/ Return Parameter	<NR1>	0~30(GPIB address) / 1~127(CAN Node ID) / 0~63(DeviceNet MAC ID)

Example SYST:COMM:INT:ADDR 15

Sets the GPIB address or CAN Node ID or DeviceNet MAC ID to 15.

 →
 → 

:SYSTem:COMMunicate:INTerface:BAUD

Description	Sets or queries the CAN Baudrate or DeviceNet Baudrate.	
-------------	---	--

 **Note** Depends on Option interface device. The setting will only be valid after the power has been cycled.

Syntax	:SYSTem:COMMunicate:INTerface:BAUD <Baudrate(NR1)> AUTO	
Query Syntax	:SYSTem:COMMunicate:INTerface:BAUD?	

Parameter/ Return Parameter	<Baudrate(NR1)>	125000 250000 500000 1000000 (CAN Baudrate)
	<Baudrate(NR1)>	125000 250000 500000 (DeviceNet Baudrate)
Return parameter	AUTO	Automatic CAN or DeviceNet baudrate .

Example SYST:COMM:INT:BAUD?
250000
Returns the baud rate settings.

Set →

:SYSTem:COMMunicate:LAN:DHCP

→ Query

Description Turns DHCP on/off. Queries the DHCP status.

Note: The setting will only be valid after the power has
been cycled.

Syntax :SYSTem:COMMunicate:LAN:DHCP
{<bool>|OFF|ON}

Query Syntax :SYSTem:COMMunicate:LAN:DHCP?

Parameter OFF | 0 DHCP off
ON | 1 DHCP on

Return parameter <bool> Returns the DHCP status.

Set →

:SYSTem:COMMunicate:LAN:DNS

→ Query

Description Sets or queries the DNS address.

Note: The setting will only be valid after the power has
been cycled.

Syntax :SYSTem:COMMunicate:LAN:DNS <string>

Query Syntax :SYSTem:COMMunicate:LAN:DNS?

Parameter/Return <string> DNS in string format ("mask")
Applicable ASCII characters: 20H to 7EH

Example SYST:COMM:LAN:DNS "172.16.1.252"
Sets the DNS to 172.16.1.252.

Set →

:SYSTem:COMMunicate:LAN:GATeway

→ Query

Description	Sets or queries the Gateway address.
Note:	The setting will only be valid after the power has been cycled.
Syntax	:SYSTem:COMMunicate:LAN:GATeway <string>
Query Syntax	:SYSTem:COMMunicate:LAN:GATeway?
Parameter/Return	<string> Gateway address in string format ("address") Applicable ASCII characters: 20H to 7EH
Example	SYST:COMM:LAN:GAT "172.16.0.254" Sets the LAN gateway to 172.16.0.254.

:SYSTem:COMMunicate:LAN:IPADdress (Set) →
→ (Query)

Description	Sets or queries LAN IP address.
Note:	The setting will only be valid after the power has been cycled.
Syntax	:SYSTem:COMMunicate:LAN:IPADdress <string>
Query Syntax	:SYSTem:COMMunicate:LAN:IPADdress?
Parameter/Return	<string> LAN IP address in string format ("address") Applicable ASCII characters: 20H to 7EH
Example	SYST:COMM:LAN:IPAD "172.16.5.111" Sets the IP address to 172.16.5.111.

:SYSTem:COMMunicate:LAN:MAC → (Query)

Description	Returns the unit MAC address as a string. The MAC address cannot be changed.
Query Syntax	:SYSTem:COMMunicate:LAN:MAC?
Return parameter	<string> Returns the MAC address in the following format "FF-FF-FF-FF-FF-FF"
Example	SYST:COMM:LAN:MAC? 02-80-AD-20-31-B1 Returns the MAC address.

:SYSTem:COMMunicate:LAN:SMASk (Set) →
→ (Query)

Description	Sets or queries the LAN subnet mask.
Note:	The setting will only be valid after the power has been cycled.
Syntax	:SYSTem:COMMunicate:LAN:SMASk <string>
Query Syntax	:SYSTem:COMMunicate:LAN:SMASK?
Parameter/Return	<string> Subnet mask in string format ("mask") Applicable ASCII characters: 20H to 7EH
Example	SYST:COMM:LAN:SMASk "255.255.0.0" Sets the LAN mask to 255.255.0.0.

:SYSTem:COMMunicate:RLState  

Description	Enables or disables local/remote state of the instrument.
Syntax	:SYSTem:COMMunicate:RLState {LOCAL REMote RWLock LREMote}
Query Syntax	:SYSTem:COMMunicate:RLState?

Parameter/Return parameter	LOCAL	All keys are valid. This instrument is controlled by the front panel controls.
	REMOte	All keys are invalid, except for the [local] key and the ability to turn the output off.
	RWLock	All keys are invalid. The instrument can only be controlled remotely.
	LREMOte	All keys are valid. This instrument is controlled by the front panel controls and remotely.

Example :SYST:COMM:RLST LOCAL
Sets the operating mode to local.

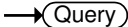
:SYSTem:COMMunicate:SERial[:RECeive] 
:TRANsmit:BAUD 

Description Sets or queries the UART baud rate.

Note: The setting will only be valid after the power has been cycled.

Syntax :SYSTem:COMMunicate:SERial[:RECeive]:TRANsmit
:BAUD <NR1>

Query Syntax :SYSTem:COMMunicate:SERial[:RECeive]:TRANsmit
:BAUD?

Parameter/Return <NR1> 1200, 2400, 4800, 9600, 19200, 38400,
57600, 115200

Example SYST:COMM:SER:TRAN:BAUD?
9600
Returns the baud rate settings.

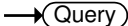
:SYSTem:COMMunicate:SERial[:RECeive] 
:TRANsmit:BITS 

Description Sets or queries the UART number of data bits.

Note: The setting will only be valid after the power has been cycled.



Syntax :SYSTem:COMMunicate:SERial[:RECeive]:TRANsmit
:BITS <NR1>

Query Syntax :SYSTem:COMMunicate:SERial[:RECeive]:TRANsmit
:BITS?

Parameter 0 7 bits
1 8 bits

Return parameter +0 7 bits
+1 8 bits

Example SYST:COMM:SER:TRAN:BITS?
+1
Indicates that 8 data bits are used for the UART connection.

:SYSTem:COMMunicate:SERial[:RECeive] 
:TRANsmit:PARity 

Description Sets or queries the parity of the UART connection.

Note: The setting will only be valid after the power has been cycled.

Syntax :SYSTem:COMMunicate:SERial[:RECeive]:TRANsmit

Query Syntax :PARity {NONE|ODD|EVEN}
:SYSTem:COMMunicate:SERial[:RECeive]:TRANsmit
:PARity?

Parameter NONE No parity
ODD Odd parity
EVEN Even parity

Return parameter +0 No parity
+1 Odd parity
+2 Even parity

Example SYST:COMM:SER:TRAN:PARity?
+0
Indicates that no parity is used for the UART connection.

:SYSTem:COMMunicate:SERial[:RECEive] Set →
 :TRANsmmit:SBITs Query

Description	Sets or queries the number of stop bits used for the UART connection.	
Note:	The setting will only be valid after the power has been cycled.	
Syntax	:SYSTem:COMMunicate:SERial[:RECEive]:TRANsmmit:SBITs <NR1>	
Query Syntax	:SYSTem:COMMunicate:SERial[:RECEive]:TRANsmmit:SBITs?	
Parameter	0	1 stop bit
	1	2 stop bits
Return parameter	+0	1 stop bit
	+1	2 stop bits
Example	SYST:COMM:SER:TRAN:SBITs? +1 Indicates that one stop bit is used for the UART connection.	

:SYSTem:COMMunicate:TCPip:CONTRol Query

Description	Queries the socket port number.	
Query Syntax	:SYSTem:COMMunicate:TCPip:CONTRol?	
Return parameter	<NR1>	0000 ~ 9999
Example	SYST:COMM:TCP:CONT? 5025 Returns the socket port number.	

:SYSTem:COMMunicate:USB:FRONT:STATe → **Query**

Description	Queries the front panel USB-A port state.
Query Syntax	:SYSTem:COMMunicate:USB:FRONT:STATe?
Return parameter	+0 <NR1>Absent +1 <NR1>Mass Storage

:SYSTem:COMMunicate:USB:REAR:STATe → **Query**

Description	Queries the rear panel USB-B port state.
Query Syntax	:SYSTem:COMMunicate:USB:REAR:STATe?
Return parameter	+0 <NR1>Absent +1 <NR1>Connected to the PC

Set →

:SYSTem:CONFigure[:MODE] → **Query**

Description	Sets or queries the test mode for the power supply.
Syntax	:SYSTem:CONFigure[:MODE] {<NR1> CONTInuous SEQuence SIMulation} (SEQ is available for AC+DC-INT, AC-INT, DC-INT Modes, whilst SIM is available for AC+DC-INT Mode.)
Query Syntax	:SYSTem:CONFigure[:MODE]?
Parameter	CONTInuous 0 Continuous mode (normal operating mode) SEQuence 1 Sequence mode SIMulation 2 Simulation mode
Return parameter	<NR1> CONT Continuous mode (normal operating mode) SEQ Sequence mode SIM Simulation mode

Set →
 → Query

:SYSTem:CONFigure:EXTio[:STATe]

Description	Sets or queries the external control state on/off.
Syntax	:SYSTem:CONFigure:EXTio[:STATe] {<bool> OFF ON}
Query Syntax	:SYSTem:CONFigure:EXTio[:STATe]?
Parameter	OFF 0 Turns the external control off. ON 1 Turns the external control on.
Return parameter	<bool> Returns the external control status.

Set →
 → Query

:SYSTem:CONFigure:TRIGger:OUTPut:SOURce

Description	Sets or queries the trigger output source. (For single-phase, only L1 can be set. For single-phase three-wire, L1 and L2 can be set.)
Syntax	:SYSTem:CONFigure:TRIGger:OUTPut:SOURce{<NR 1> L1 L2 L3}
Query Syntax	:SYSTem:CONFigure:TRIGger:OUTPut:SOURce?
Parameter/ Return parameter	<NR1> From 0 ~ 2, which represent different phase select, respectively. L1 0 L1 phase L2 1 L2 phase L3 2 L3 phase
Example	:SYST:CONF:TRIG:OUTP:SOUR L2 Sets the trigger output source to L2.

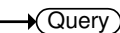
:SYSTem:CONFigure:TRIGger:OUTPut:WIDTh  

Description	Sets or queries the type of trigger output. The trigger output can be set as a user-defined pulse width or as a trigger output level.						
Syntax	:SYSTem:CONFigure:TRIGger:OUTPut:WIDTh {<NR2> MINimum MAXimum}						
Query Syntax	:SYSTem:CONFigure:TRIGger:OUTPut:WIDTh? [MINimum MAXimum]						
Parameter	<table border="0"> <tr> <td><NR2></td> <td>0.0001 ~ 0.06</td> </tr> <tr> <td>MINimum</td> <td>0.0001</td> </tr> <tr> <td>MAXimum</td> <td>0.06</td> </tr> </table>	<NR2>	0.0001 ~ 0.06	MINimum	0.0001	MAXimum	0.06
<NR2>	0.0001 ~ 0.06						
MINimum	0.0001						
MAXimum	0.06						
Return parameter	<NR2> Returns the trigger output width.						
Example	:SYST:CONF:TRIG:OUTP:WIDT 0.005 Sets the trigger output width to 5ms.						

:SYSTem:ERRor 

Description	Queries the error queue. The last error message is returned. A maximum of 32 errors are stored in the error queue.
Query Syntax	:SYSTem:ERRor?
Return parameter	<string> Returns an error code followed by an error message as a single string.
Example	SYSTem:ERRor? -100, "Command error"

:SYSTem:ERRor:ENABle 

Description	Clears the Error Queue and enables all error messages to be placed in the System Error Queue.
Syntax	:SYSTem:ERRor:ENABle

:SYSTem:HOLD:STATe (Set) →
→ (Query)

Description	Sets or queries the freeze hold state on/off.	
Syntax	:SYSTem:HOLD:STATe {<bool> OFF ON}	
Query Syntax	:SYSTem:HOLD:STATe?	
Parameter	OFF 0	Turns the freeze hold off.
	ON 1	Turns the freeze hold on.
Return parameter	<bool>	Returns the freeze hold status.

:SYSTem:PKHold:TIME (Set) →
→ (Query)

Description	Sets or queries the peak hold time for peak measurement when output on.	
Syntax	:SYSTem:PKhold:TIME {<NR1>}	
Query Syntax	:SYSTem:PKhold:TIME?	
Parameter	<NR1>	1~60,000
Example	:SYST:PKH:TIME 10 Sets the peak hold time 10ms to measure when output on.	

:SYSTem:KLOCK (Set) →
→ (Query)

Description	Enables or disables the front panel key lock.	
Syntax	:SYSTem:KLOCK {<bool> OFF ON}	
Query Syntax	:SYSTem:KLOCK?	
Parameter	OFF 0	Panel keys unlocked
	ON 1	Panel keys locked
Return parameter	<bool>	Returns the key lock status.

:SYSTem:REBoot

Set →

Description Reboots the ASR system.

Syntax :SYSTem:REBoot

Set →

:SYSTem:VUNit

→ Query

Description Sets or Queries the Unit of Voltage Setting in Specific Wave Shape(TRI or ARB)

Syntax :SYSTem:VUNit <bool> | RMS | P-P

Query Syntax :SYSTem:VUNit?

Parameter	RMS 0	Sets V Unit (TRI, ARB) as rms
	P-P 1	Sets V Unit (TRI, ARB) as p-p

Return parameter <bool> Returns the V Unit(TRI, ARB) setting.

Example :SYSTem:VUNit?
+1
Returns the V Unit(TRI, ARB) setting.

Source Commands

:SYSTem:CONFigure:PHASe.....	121
:INSTrument:EDIT	122
:INSTrument:SElect.....	122
[:SOURce]:CURRent:LIMit:PEAK:HIGH.....	123
[:SOURce]:CURRent:LIMit:PEAK:LOW.....	123
[:SOURce]:CURRent:LIMit:RMS[:AMPLitude]	124
[:SOURce]:CURRent:LIMit:PEAK:MODE	124
[:SOURce]:CURRent:LIMit:RMS:MODE	125
[:SOURce]:FREQuency:LIMit:HIGH	125
[:SOURce]:FREQuency:LIMit:LOW.....	126
[:SOURce]:FREQuency[:IMMediate].....	126
[:SOURce]:FUNCTion[:SHAPE][:IMMediate]	127
[:SOURce]:FUNCTion:THD:FORMat.....	129
[:SOURce]:LINE:VOLTag[:LEVel][:IMMediate][:AMPLitude]	129
[:SOURce]:LINE:VOLTag[:LEVel][:IMMediate]:OFFSet.....	130
[:SOURce]:MODE	130
[:SOURce]:PHASe:BALance	131
[:SOURce]:PHASe:MODE.....	131
[:SOURce]:PHASe:PHASe	132
[:SOURce]:PHASe:RELock.....	132
[:SOURce]:PHASe:SETChange:STATe.....	133
[:SOURce]:PHASe:START:STATe	133
[:SOURce]:PHASe:STOP:STATe.....	134
[:SOURce]:PHASe:START[:IMMediate]	134
[:SOURce]:PHASe:STOP[:IMMediate].....	135
[:SOURce]:PHASe:SYNC[:IMMediate]	135
[:SOURce]:READ	136
[:SOURce]:VOLTag:RANGe.....	136
[:SOURce]:VOLTag:RESPonse	137
[:SOURce]:VOLTag:LIMit:RMS	137
[:SOURce]:VOLTag:LIMit:PEAK.....	138
[:SOURce]:VOLTag:LIMit:HIGH	138
[:SOURce]:VOLTag:LIMit:LOW	139
[:SOURce]:VOLTag[:LEVel][:IMMediate]	

[:AMPLitude]139
 [:SOURce]:VOLTage[:LEVel][:IMMediate]:OFFSet
140
 [:SOURce]:SQUare:DCYCLE140

:SYSTem:CONFigure:PHASe



Description Sets or queries the phase configuration. (Only Continuous Mode Active)

Syntax SYSTem:CONFigure:PHASe <NR1>

Query Syntax SYSTem:CONFigure:PHASe?

Parameter	<NR1>	From 0 – 2 which represent different configure phase, respectively.
	0	3P4W
	1	1P2W
	2	1P3W

Return parameter 3P4W

Example :SYST:CONF:PHAS?

3P4W

Returns the system configure phase as 3P4W.

:INSTrument:EDIT

Set →

→ Query

Description Sets or queries instrument edit. It is convenient to use a programmed command to set all phases at the same time. If INST:EDIT ALL has been programmed, it will sent all phases.

(Only three-phase four-wire)

Syntax INSTrument:EDIT {<NR1>|EACH|ALL}

Query Syntax INSTrument:EDIT ?

Parameter/ <NR1> | EACH (0) | ALL (1)

Return parameter

EACH 0 Each phase

ALL 1 All phase

Example :INST:EDIT ALL

Sets instrument edit all phase.

Set →

→ Query

:INSTrument:SElect

Description Sets or queries the phase to set continuous mode. This command affects the setting of the measurement phase. If INST: EDIT ALL has been programmed, all remote operation commands will send to all output phases.

(For single-phase, only L1 can be set. For single-phase three-wire, L1and L2 can be set.)

Syntax :INSTrument:SElect {<NR1>|L1|L2|L3}

Query Syntax :INSTrument:SElect?

Parameter/ <NR1> From 0 ~ 2, which represent different phase to set sequence, respectively.

Return parameter

L1 | 0 L1 phase

L2 | 1 L2 phase

L3 | 2 L3 phase

Example :INST:SEL L2

Sets the L2 phase to set continuous mode.

`[:SOURce]:CURRent:LIMit:PEAK:HIGH`  

Description	Sets or queries the Ipk-High Limit parameter for the continuous operation mode.	
Syntax	[:SOURce]:CURRent:LIMit:PEAK:HIGH {<NR2> MINimum MAXimum}	
Query Syntax	[:SOURce]:CURRent:LIMit:PEAK:HIGH? [MINimum MAXimum]	
Parameter	<NR2>	Ipk-High Limit in Arms.
	MINimum	Minimum settable peak current high limit
	MAXimum	Maximum settable peak current high limit
Return parameter	<NR2>	Returns the Ipk-High Limit value
Example	CURR:LIM:PEAK:HIGH? +42.0000 Returns the peak current high limit as +42.0 A.	

`[:SOURce]:CURRent:LIMit:PEAK:LOW`  

Description	Sets or queries the Ipk-Low Limit parameter for the continuous operation mode.	
Syntax	[:SOURce]:CURRent:LIMit:PEAK:LOW {<NR2> MINimum MAXimum}	
Query Syntax	[:SOURce]:CURRent:LIMit:PEAK:LOW? [MINimum MAXimum]	
Parameter	<NR2>	Ipk-Low Limit in Arms.
	MINimum	Minimum settable peak current low limit
	MAXimum	Maximum settable peak current low limit
Return parameter	<NR2>	Returns the Ipk-Low Limit value
Example	:CURR:LIM:PEAK:LOW? -42.0000 Returns the peak current low limit as -42.0 A.	

[:SOURce]:CURRent:LIMit:RMS (Set) →
 [:AMPLitude] → (Query)

Description	Sets or queries the Irms parameter for the continuous operation mode.	
Syntax	[:SOURce]:CURRent:LIMit:RMS[:AMPLitude] {<NR2> MINimum MAXimum}	
Query Syntax	[:SOURce]:CURRent:LIMit:RMS[:AMPLitude]? [MINimum MAXimum]	
Parameter	<NR2>	Irms in A.
	MINimum	Minimum settable current
	MAXimum	Maximum settable current
Return parameter	<NR2>	Returns the Irms.
Example	:CURR:LIM:RMS? +10.5000 Returns the Irms setting.	

[:SOURce]:CURRent:LIMit:PEAK:MODE (Set) →
→ (Query)

Description	Sets or queries Ipk limit enabled or disabled.	
Syntax	[:SOURce]:CURRent:LIMit:PEAK:MODE {<bool> OFF ON}	
Query Syntax	[:SOURce]:CURRent:LIMit:PEAK:MODE?	
Parameter/	<bool>	OFF (0) ON (1)
Return parameter	OFF 0	Ipk limit off
	ON 1	Ipk limit on
Example	:CURR:LIM:PEAK:MODE ON Sets Ipk limit enabled.	

`[[:SOURce]:CURRent:LIMit:RMS:MODE` (Set) →
→ (Query)

Description	Sets or queries IRMS limit status.	
Syntax	[:SOURce]:CURRent:LIMit:RMS:MODE {<bool> OFF ON}	
Query Syntax	[:SOURce]:CURRent:LIMit:RMS:MODE?	
Parameter/ Return parameter	<bool> OFF 0 ON 1	OFF (0) ON (1) IRMS limit off IRMS limit on
Example	:CURR:LIM:RMS:MODE ON Sets IRMS limit enabled.	

`[[:SOURce]:FREQuency:LIMit:HIGH` (Set) →
→ (Query)

Description	Sets or queries the frequency upper limit range. (Only AC+DC-INT or AC-INT or AC+DC-ADD or AC-ADD or AC-VCA Active)	
Syntax	[:SOURce]:FREQuency:LIMit:HIGH {<NR2> MINimum MAXimum}	
Query Syntax	[:SOURce]:FREQuency:LIMit:HIGH? [INimum MAXimum]	
Parameter	<NR2> MINimum MAXimum	Frequency in Hz. Minimum settable frequency Maximum settable frequency
Return parameter	<NR2>	Returns the frequency limit
Example	FREQ:LIM:HIGH? +999.9000 Returns the frequency upper limit.	

[:SOURce]:FREQuency:LIMit:LOW (Set) →
→ (Query)

Description	Sets or queries the frequency lower limit range. (Only AC+DC-INT or AC-INT or AC+DC-ADD or AC-ADD or AC-VCA Active)	
Syntax	[:SOURce]:FREQuency:LIMit:LOW {<NR2> MINimum MAXimum}	
Query Syntax	[:SOURce]:FREQuency:LIMit:LOW? [INimum MAXimum]	
Parameter	<NR2>	Frequency in Hz.
	MINimum	Minimum settable frequency
	MAXimum	Maximum settable frequency
Return parameter	<NR2>	Returns the frequency limit
Example	FREQ:LIM:LOW? +1.0000 Returns the frequency lower limit.	

[:SOURce]:FREQuency[:IMMEDIATE] (Set) →
→ (Query)

Description	Sets or queries the frequency for the immediate trigger. (Only AC+DC-INT or AC-INT or AC+DC-ADD or AC-ADD or AC-VCA Active)	
Syntax	[:SOURce]:FREQuency[:IMMEDIATE] {<NR2>(HZ) MINimum MAXimum}	
Query Syntax	[:SOURce]:FREQuency[:IMMEDIATE]? [MINimum MAXimum]	
Parameter/Return parameter	<NR2>	Frequency setting in Hz.
	MINimum	Minimum frequency
	MAXimum	Maximum frequency
Example	:FREQ 60 Sets the frequency of 60Hz.	

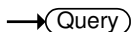
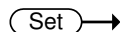

[[:SOURce]:FUNction[:SHApe]][:IMMediate]

Description Sets or queries the waveforms of power supply. (Not available for DC-INT, AC+DC-EXT and AC-EXT)

Syntax [[:SOURce]:FUNction[:SHApe]][:IMMediate] {<NR1>|ARB1|ARB2|ARB3|ARB4| ... |ARB13|ARB14|ARB15|ARB16|SIN|SQU|TRI|ARB17|ARB18|ARB19|ARB20| ... |ARB250|ARB251|ARB252|ARB253}

Query Syntax [[:SOURce]:FUNction[:SHApe]][:IMMediate]?

Parameter / Return parameter <NR1> From 0 – 255, which represent different waveforms, respectively.

Parameter	ARB1 0	Arbitrary wave 1
	ARB2 1	Arbitrary wave 2
	ARB3 2	Arbitrary wave 3
	ARB4 3	Arbitrary wave 4
	.	
	.	
	.	
	ARB13 12	Arbitrary wave 13
	ARB14 13	Arbitrary wave 14
	ARB15 14	Arbitrary wave 15
	ARB16 15	Arbitrary wave 16
	SIN 16	Sin wave
	SQU 17	Square wave
	TRI 18	Triangle wave
	ARB17 19	Arbitrary wave 17
	ARB18 20	Arbitrary wave 18
	ARB19 21	Arbitrary wave 19
	ARB20 22	Arbitrary wave 20
	.	
	.	
	.	
	ARB250 252	Arbitrary wave 250
	ARB251 253	Arbitrary wave 251
	ARB252 254	Arbitrary wave 252
	ARB253 255	Arbitrary wave 253

Example :SOUR:FUNC:SHAP:IMM?
 TRI
 Returns the waveform as Triangle wave.

`[:SOURce]:FUNCtion:THD:FORMat`

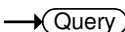

Description	Sets or queries the THD format.	
Syntax	[:SOURce]:FUNCtion:THD:FORMat {<bool> IEC CSA}	
Query Syntax	[:SOURce]:FUNCtion:THD:FORMat?	
Parameter / Return parameter	<bool>	IEC (0) CSA (1)
	IEC 0	IEC THD format
	CSA 1	CSA THD format
Example	:SOUR:FUNC:THD:FORM? IEC Returns the THD format as IEC.	

`[:SOURce]:LINE:VOLTage[:LEVel][:IMMedia te][:AMPLitude]`



Description	Sets or queries the RMS line voltage for the continuous operation mode. (Not available in phase mode unbalance and DC-INT, AC+DC-EXT, AC-EXT , AC+DC-ADD, AC-ADD and AC-VCA)	
Syntax	[:SOURce]:LINE:VOLTage[:LEVel][:IMMediate][:AMPLitude]{<NR2>(V) MINimum MAXimum}	
Query Syntax	[:SOURce]:LINE:VOLTage[:LEVel][:IMMediate][:AMPLitude]?[MINimum MAXimum]	
Parameter / Return parameter	<NR2>	Vrms
	MINimum	Minimum line voltage
	MAXimum	Maximum line voltage
Example	:LINE:VOLT 150.0 Sets the line voltage to 150.0 ACV.	

`[[:SOURce]:LINE:VOLTage[:LEVel][:IMMedia te]:OFFSet` (Set) →
→ (Query)

Description	Sets or queries the line voltage offset value. (Not available in phase mode unbalance and only AC+DC-INT or AC+DC-Sync Active)	
Syntax	[:SOURce]:LINE:VOLTage[:LEVel][:IMMediate]:OFFSet {<NR2>(V) MINimum MAXimum}	
Query Syntax	[:SOURce]:LINE:VOLTage[:LEVel][:IMMediate]:OFFSet? [MINimum MAXimum]	
Parameter / Return parameter	<NR2>	Voltage offset value
	MINimum	Minimum line voltage offset value
	MAXimum	Maximum line voltage offset value

Example :LINE:VOLT:OFFS?
 +150.0000

 Returns the line voltage offset value as 150.0.

`[[:SOURce]:MODE` (Set) →
→ (Query)

Description	Sets or queries the output mode of power supply.	
Syntax	[:SOURce]:MODE {<NR1> ACDC-INT AC-INT DC-INT ACDC-EXT AC-EXT ACDC-ADD AC-ADD ACDC-SYNC AC-SYNC AC-VCA}	
Query Syntax	[:SOURce]:MODE?	
Parameter / Return parameter	<NR1>	From 0 - 9, which represent different output modes, respectively.
	ACDC-INT 0	AC+DC-INT
	AC-INT 1	AC-INT
	DC-INT 2	DC-INT
	ACDC-EXT 3	AC+DC-EXT
	AC-EXT 4	AC-EXT
	ACDC-ADD 5	AC+DC-ADD
	AC-ADD 6	AC-ADD

ACDC-SYNC 7	AC+DC-SYNC
AC-SYNC 8	AC-SYNC
AC-VCA 9	AC-VCA

Example `MODE?`
 `ACDC-INT`
 Returns the output mode as AC+DC-INT.

[[:SOURce]:PHASe:BALance

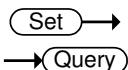

Description Sets or queries the balance setting phase or line.
 (Only phase mode is balance Active)

Syntax `[[:SOURce]:PHASe:BALance{<bool>|PHASe|LINE}`

Query Syntax `[[:SOURce]:PHASe:BALance?`

Parameter / Return parameter	<code><bool></code>	<code> PHASe (0) LINE (1)</code>
	<code>PHASe 0</code>	Phase setting
	<code>LINE 1</code>	Line setting

Example `:PHAS:BAL?`
 `LINE`
 Returns the balance setting as LINE.

[[:SOURce]:PHASe:MODE

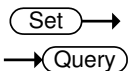

Description Sets or queries the balance mode.
 (Only three-phase four-wire Active)

Syntax `[[:SOURce]:PHASe:MODE{<bool>|UNBalance |BALance}`

Query Syntax `[[:SOURce]:PHASe:MODE?`

Parameter / Return parameter	<code><bool></code>	<code> UNBalance (0) BALance (1)</code>
	<code>UNBalance 0</code>	UNBalance
	<code>BALance 1</code>	Balance

Example `:PHAS:MODE?`
 `Balance`
 Returns the phase mode as Balance.

Set →

→ Query

[:SOURce]:PHASe:PHASe

Description Sets or queries the target and phase angle parameter. (For three-phase four-wire, L12 and L13 can be set. For single-phase three-wire, L12 can be set.)

Syntax [:SOURce]:PHASe:PHASe <NR1> [L12] L13,<NR2> | MINimum | MAXimum

Query Syntax [:SOURce]:PHASe:PHASe?

Parameter <target>

<NR1>	
L12	0 Phase angle between L1-L2
L13	1 Phase angle between L1-L3

Parameter <phase angle>

<NR2>	
MINimum	0
MAXimum	359.9

Return parameter <target>,<phase angle> Returns the the target and phase angle parameter.

Example :PHAS:PHAS? L12
+120.0
Returns the Phase angle 120.0 between L1-L2.

Set →

→ Query

[:SOURce]:PHASe:RELock

Description Sets or queries the relock function in three-phase mode.

Syntax [:SOURce]:PHASe:RELock {<bool>|OFF|ON}

Query Syntax [:SOURce]:PHASe:RELock?

Parameter/ Return parameter <bool>

<bool>	OFF (0) ON (1)
OFF	0 Phase relock off
ON	1 Phase relock on

Example :PHAS:REL ON
Sets Phase relock enabled

[[:SOURce]:PHASe:SETChange:STATe



Description	Sets or queries the set change phase state.	
Syntax	[:SOURce]:PHASe:SETChange:STATe {<bool> OFF ON}	
Query Syntax	[:SOURce]:PHASe:SETChange:STATe?	
Parameter/ Return parameter	<bool> OFF ON	OFF (0) ON (1) 0 Set change phase off 1 Set change phase on
Example	:PHAS:SETC:STAT ON Sets change phase enabled	

[[:SOURce]:PHASe:STARt:STATe



Description	Sets or queries state of start phase. (Not available for DC-INT, AC+DC-EXT and AC-EXT)	
Syntax	[:SOURce]:PHASe:STARt:STATe {<bool> FREE FIXED}	
Query Syntax	[:SOURce]:PHASe:STARt:STATe?	
Parameter/ Return parameter	<bool> FREE 0 FIXED 1	FREE (0) FIXED (1) Start phase Free Start phase Fixed
Example	:PHAS:STAR:STAT? FREE Returns the state of start phase as Free.	

[[:SOURce]:PHASe:STOP:STATe (Set) →
→ (Query)

Description	Sets or queries state of stop phase. (Not available for DC-INT, AC+DC-EXT and AC-EXT)	
Syntax	[:SOURce]:PHASe:STOP:STATe {<bool> FREE FIXED}	
Query Syntax	[:SOURce]:PHASe:STOP:STATe?	
Parameter/ Return parameter	<bool> FREE 0 FIXED 1	FREE (0) FIXED (1) Start phase Free Start phase Fixed
Example	:PHAS:STOP:STAT? FIXED Returns the state of stop phase as Fixed.	

[[:SOURce]:PHASe:STARt[:IMMEDIATE] (Set) →
→ (Query)

Description	Sets or queries the start phase. (Not available for DC-INT, AC+DC-EXT and AC-EXT)	
Syntax	[:SOURce]:PHASe:STARt[:IMMEDIATE] {<NR2> MINimum MAXimum}	
Query Syntax	[:SOURce]:PHASe:STARt[:IMMEDIATE]? [MINimum MAXimum]	
Parameter/Return parameter	<NR2> MINimum MAXimum	Start phase value 0° 359.9 °
Example	:PHAS:STAR 0 Sets the starting phase to 0.	

[[:SOURce]:PHASe:STOP[:IMMediate]]



Description	Sets or queries the off phase of the waveform. (Not available for DC-INT, AC+DC-EXT and AC-EXT)	
Note:	Sets the off phase of the waveform after the output has been turned off.	
Syntax	[:SOURce]:PHASe:STOP[:IMMediate] {<NR2> MINimum MAXimum}	
Query Syntax	[:SOURce]:PHASe:STOP[:IMMediate]? [MINimum MAXimum]	
Parameter/Return parameter	<NR2> MINimum MAXimum	Stop phase value 0 ° 359.9 °
Example	:PHAS:STOP 60 Sets the stop phase to 60.	

[[:SOURce]:PHASe:SYNC[:IMMediate]]



Description	Sets or queries the sync delay phase. (Only AC+DC-sync or AC-sync Active)	
Syntax	[:SOURce]:PHASe:SYNC[:IMMediate] {<NR2> MINimum MAXimum}	
Query Syntax	[:SOURce]:PHASe:SYNC[:IMMediate]? [MINimum MAXimum]	
Parameter/Return parameter	<NR2> MINimum MAXimum	Sync delay phase value 0 ° 359.9 °
Example	:PHAS:SYNC 0 Sets the sync delay phase to 0.	

[:SOURce]:READ

→ **Query**

Description	Returns the measurement readouts.	
Query Syntax	[:SOURce]:READ?	
Return parameter	<Vrms>,<Vavg>,<Vmax>,<Vmin>,<I rms>,<Iavg>,<Im ax>,<Imin>,<IpkH >,<P>,<S>,<Q>,< PF>,<CF>,<THDv >,<THDi>,<Freq>	<THDv>,<THDi> returns values in AC-INT mode only, whereas returns Invalid in other modes. <S>,<Q>,<PF>,<CF> returns Invalid in DC-INT mode. <Freq> returns values in AC+DC-Sync and AC-Sync modes only, whereas returns Invalid in other modes.

Example :READ?
 >+0.3204,+0.0306,+0.1879,-0.5809,+0.0121, -0.0007,
 +0.0030, -0.0060, -0.0201, +0.0013, +0.0039, +0.0037,
 +0.3400, +1.1500, Invalid, Invalid, Invalid

Set →

[:SOURce]:VOLTage:RANGe

→ **Query**

Description	Sets or queries the voltage range.	
Syntax	[:SOURce]:VOLTage:RANGe {<NR1> 100 200 AUTO}	
Query Syntax	[:SOURce]:VOLTage:RANGe?	
Parameter / Return parameter	<NR1>	From 0 - 2, which represent different voltage ranges, respectively.
	100 0	100V
	200 1	200V
	AUTO 2	AUTO (Only AC+DC-INT or AC-INT or DC-INT or AC+DC-sync or AC-sync Active)

Example :SOUR:VOLT:RANG?
 200
 Returns the voltage range as 200V.

Set →
 → Query

[[:SOURce]:VOLTage:RESPonse

Description Sets or queries the voltage response.
 (Fast not available for single-phase or output impedance set to on.)

Syntax [[:SOURce]:VOLTage:RESPonse
 {<NR1>|SLOW|MEDIum|FAST}

Query Syntax [[:SOURce]:VOLTage:RESPonse?

Parameter / Return parameter	<NR1> SLOW 0 MEDIum 1 FAST 2	From 0 - 2, which represent different voltage response ,respectively. Voltage response slow. Voltage response medium. Voltage response fast.
---	---	---

Example VOLT:RESP?
 +1
 Returns the voltage response as medium.

Set →
 → Query

[[:SOURce]:VOLTage:LIMit:RMS

Description Sets or queries the voltage limit for the continuous operation mode. (Only AC-INT or AC-ADD or AC-Sync Active)

Syntax [[:SOURce]:VOLTage:LIMit:RMS
 {<NR2>|MINimum|MAXimum}

Query Syntax [[:SOURce]:VOLTage:LIMit:RMS?
 [MINimum|MAXimum]

Parameter	<NR2> MINimum MAXimum	Vrms. Minimum voltage limit Maximum voltage limit
Return parameter	<NR2>	Returns the voltage limit.

Example VOLT:LIM:RMS?
 +350.0000
 Returns the Vrms limit.

Set →

[:SOURce]:VOLTage:LIMit:PEAK

→ Query

Description	Sets or Queries the Value of Vpp in Specific Mode(AC-INT or AC-ADD or AC-Sync) and Specific Wave Shape(TRI or ARB) and Specific V Unit(p-p)
Syntax	[:SOURce]:VOLTage:LIMit:PEAK <NR2> MINimum MAXimum
Query Syntax	[:SOURce]:VOLTage:LIMit:PEAK? [MINimum MAXimum]
Parameter	<NR2> Vpp MINimum Minimum Vpp limit MAXimum Maximum Vpp limit
Return parameter	<NR2> Returns the Vpp limit.
Example	VOLT:LIM:PEAK? +500.0000 Returns the Vpp limit.

Set →

[:SOURce]:VOLTage:LIMit:HIGH

→ Query

Description	Sets or queries the voltage high limit. (Only AC+DC-INT or DC-INT or AC+DC-ADD or AC+DC-Sync Active)
Syntax	[:SOURce]:VOLTage:LIMit:HIGH {<NR2> MINimum MAXimum}
Query Syntax	[:SOURce]:VOLTage:LIMit:HIGH? [MINimum MAXimum]
Parameter	<NR2> Voltage high limit MINimum Minimum voltage high limit MAXimum Maximum voltage high limit
Return parameter	<NR2> Returns the voltage high limit.
Example	VOLT:LIM:HIGH? +500.0000 Returns the voltage high limit.

`[:SOURce]:VOLTage:LIMit:LOW`



Description Sets or queries the voltage low limit. (Only AC+DC-INT or DC-INT or AC+DC-ADD or AC+DC-Sync Active)

Syntax `[:SOURce]:VOLTage:LIMit:LOW`
`{<NR2>|MINimum|MAXimum}`

Query Syntax `[:SOURce]:VOLTage:LIMit:LOW?`
`[MINimum|MAXimum]`

Parameter

<code><NR2></code>	Voltage low limit
<code>MINimum</code>	Minimum voltage low limit
<code>MAXimum</code>	Maximum voltage low limit

Return parameter `<NR2>` Returns the voltage low limit.

Example `VOLT:LIM:LOW?`
`-500.0000`
Returns the voltage low limit.

`[:SOURce]:VOLTage[:LEVel][:IMMediate]`

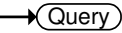

`[:AMPLitude]`

Description Sets or queries the RMS voltage for the continuous operation mode. (Not available for DC-INT, AC+DC-EXT, AC-EXT and AC-VCA)

Syntax `[:SOURce]:VOLTage[:LEVel][:IMMediate][:AMPLitude]`
`{<NR2>(V)|MINimum|MAXimum}`

Query Syntax `[:SOURce]:VOLTage[:LEVel][:IMMediate][:AMPLitude]?`
`[MINimum|MAXimum]`

Parameter/Return parameter

<code><NR2></code>	Vrms.
<code>MINimum</code>	Minimum voltage
<code>MAXimum</code>	Maximum voltage

Example `:VOLT 150.0`
Sets the voltage to 150.0 ACV.

[[:SOURce]:VOLTage[:LEVel]][:IMMediate]:OFFSet Set →
→Query

Description	Sets or queries the voltage offset value. (Only AC+DC-INT or DC-INT or AC+DC-ADD or AC+DC-Sync Active)	
Syntax	[:SOURce]:VOLTage[:LEVel]][:IMMediate]:OFFSet {<NR2>(V) MINimum MAXimum}	
Query Syntax	[:SOURce]:VOLTage[:LEVel]][:IMMediate]:OFFSet? [MINimum MAXimum]	
Parameter/Return parameter	<NR2>	Voltage offset value
	MINimum	Minimum voltage offset value
	MAXimum	Maximum voltage offset value
Example	:VOLT:OFFS? +150.0000 Returns the voltage offset value as 150.0.	

Set →

[[:SOURce]:SQUare:DCYcle →Query

Description	Sets or queries the square wave signal duty cycle. The settable range depends on the frequency. (Not available for DC-INT, AC+DC-EXT and ACEXT)	
Syntax	[:SOURce]:SQUare:DCYcle {<NR2> MINimum MAXimum}	
Query Syntax	[:SOURce]:SQUare:DCYcle?	
Parameter/Return parameter	<NR2>	square wave signal duty cycle.
	MINimum	Minimum square wave signal duty cycle.
	MAXimum	Maximum square wave signal duty cycle.
Example	:SQU:DCYC? +50.0 Returns the square wave signal duty cycle as 50.0%.	

Sequence Commands

[[:SOURce]:SEQuence:INSTrument:SELect.....	141
[[:SOURce]:SEQuence:CPARAmeter	142
[[:SOURce]:SEQuence:CSTep.....	143
[[:SOURce]:SEQuence:CTIME.....	143
[[:SOURce]:SEQuence:CJUMp:CNT	143
[[:SOURce]:SEQuence:NSPArAmeter	144
[[:SOURce]:SEQuence:SPARAmeter	145
[[:SOURce]:SEQuence:STEP	146
[[:SOURce]:SEQuence:CONDition	147
:TRIGGer:SEQuence:SELected:EXECute	147

[[:SOURce]:SEQuence:INSTrument:SELect  

Description	Sets or queries the phase to set sequence.(Only Sequence Mode Active. For single-phase and single-phase three-wire, only L1 can be set.	
Syntax	[:SOURce]:SEQuence:INSTrument:SELect {<NR1> L1 L2 L3}	
Query Syntax	[:SOURce]:SEQuence:INSTrument:SELect?	
Parameter/ Return parameter	<NR1> L1 0 L2 1 L3 2	From 0 ~ 2, which represent different phase to set sequence, respectively. L1 phase L2 phase L3 phase
Example	:SEQ:INST:SEL L2 Sets the L2 phase to set sequence .	

Set →

→ Query

[:SOURce]:SEQuence:CPARameter

Description	Sets the common parameters for the Sequence mode. Please see the user manual for a full description of each parameter. (Only Sequence Mode Active)	
Syntax	[:SOURce]:SEQuence:CPARameter {<NR2>,<NR2>,<bool> OFF ON,<NR2>,<bool> OFF ON,<NR1> CONTInue END HOLD,<NR1>,<bool> OFF ON,<NR1>,<bool> OFF ON,<NR1>,<bool> OFF ON,<NR1>,<bool> OFF ON}	
Query Syntax	[:SOURce]:SEQuence:CPARameter?	
Parameter	<NR2>	Step Time
	<NR2>	On phase
	<bool> OFF ON FR	On Phase settings:
	EE FIXED	on (fixed) (1) / off (free) (0)
	<NR2>	Off phase
	<bool> OFF ON FR	Off Phase settings:
	EE FIXED	on (fixed) (1) / off (free) (0)
	<NR1> CONTInue	Term settings:
	END HOLD	Continue(0)/End(1)/Hold(2)
	<NR1>	Jump step number (0 ~ 999)
	<bool> OFF ON	Jump on(1)/off(0)
	<NR1>	Jump Cnt (0~ 9999)
	<NR1>	Sync Code: LL(0) / LH(1) / HL(2) / HH(3)
	<NR1>	Branch1 (0 ~ 999)
	<bool> OFF ON	Branch1 on(1)/off(0)
	<NR1>	Branch2 (0 ~ 999)
	<bool> OFF ON	Branch2 on(1)/off(0)
	<bool>	Reserved (Fixed to 0)
Return parameter	<NR2>,<NR2>,<bool>,<NR2>,<bool>,<NR1>,<NR1>,<bool>,<NR1>,<NR1>,<bool>,<NR1>,<bool>,<bool>	
	Returns the common parameters in the following order: Step time, on phase, on phase on/off, off phase, off phase on/off, term settings, jump step number, jump on/off, jump count, code on/off, branch1, branch1 on/off, branch2, branch2 on/off, reserved on/off.	

Example1	:SEQ:CPAR 1,1,0,10,1,HOLD,10,1,0,1,0,0,0,0
Example2	:SEQ:CPAR? +1.0000,+1.0,+0,+10.0,+1,HOLD,+10,+1,+0,+1,+0,+0,+ 0,+0,+0

[[:SOURce]:SEQuence:CSTep → Query

Description Returns the currently running step number. (Only Sequence Mode Active)

Query Syntax [[:SOURce]:SEQuence:CSTep?

Return parameter <NR1> Current step number

Example :SEQ:CSTep?
+1

[[:SOURce]:SEQuence:CTIME → Query

Description Returns the currently running step number and elapsed time. (Only Sequence Mode Active)

Query Syntax [[:SOURce]:SEQuence:CTIME?

Return parameter <NR1> Current step number,current elapsed hours,current elapsed minutes, current elapsed second

Example :SEQ:CTIME?
+1,+0,+0,+18

[[:SOURce]:SEQuence:CJUMp:CNT → Query

Description Returns the currently running step number and jump count.If the jump to function is turned off, the returned information is "-1". If jump count is set to infinity, the returned information is "Inf".(Only Sequence Mode Active)

Query Syntax [[:SOURce]:SEQuence:CJUMp:CNT?

Return parameter <NR1> Current step number,current jump count

Example :SEQ:CJUMp:CNT?
+1,+1

[[:SOURce]:SEQuence:NSParameter

Set →

← Query

Description Sets or queries the parameters for a new specified step. (Only Sequence Mode Active)

Syntax [[:SOURce]:SEQuence:NSParameter
{<NR2>,<NR1>|CONSt|KEEp|SWEEp,<NR2>,<NR1>|CONSt|KEEp|SWEEp,<NR2>,<NR1>|CONSt|KEEp|SWEEp,SIN,<NR2>,<NR2>}

Query Syntax [[:SOURce]:SEQuence:NSParameter?

Parameter	<NR2> <NR1> CONSt KEEp SWEEp <NR2> <NR1> CONSt KEEp SWEEp <NR2> <NR1> CONSt KEEp SWEEp Waveform <NR2> <NR2>	ACV setting ACV mode: Constant(0) Keep(1) Sweep(2) DCV. Not applicable. This parameter will be ignored. DCV mode: Constant(0) Keep(1) Sweep(2) Frequency Frequency mode: Constant(0) Keep(1) Sweep(2) ARB1 ARB2 ARB3 ARB4 ... ARB13 ARB14 ARB15 ARB16 SIN SQU TRI ARB17 ARB18 ARB19 ARB20 ... ARB250 ARB251 ARB252 ARB253 Square wave signal duty cycle. Phase angle. (L1 phase Fixed to 0.)
Return parameter	<NR2>,<NR1> CONSt KEEp SWEEp,<NR2>,<NR1> CONSt KEEp SWEEp,<NR2>,<NR1> CONSt KEEp SWEEp,ARB1 ARB2 ARB3 ARB4 ... ARB13 ARB14 ARB15 ARB16 SIN SQU TRI ARB17 ARB18 ARB19 ARB20 ... ARB250 ARB251 ARB252 ARB253 Returns the step parameters in the following order: ACV, ACV mode, DCV, DCV mode, frequency, frequency mode, wave, square wave signal duty cycle, phase.	

Example :SEQ:NSP?
+0.0,CONST,+0.0,CONST,+50.00,CONST,SIN,+50.0, +0

[[:SOURce]:SEQuence:SPARAmeter 

Description Sets or queries the parameters for a specified step.
(Only Sequence Mode Active)

Syntax [[:SOURce]:SEQuence:SPARAmeter
{<NR2>,<NR1>|CONSt|KEEp|SWEEp,<NR2>,<NR1>|CONSt|KEEp|SWEEp,<NR2>,<NR1>|CONSt|KEEp|SWEEp,SIN,<NR2>}

Query Syntax [[:SOURce]:SEQuence:SPARAmeter?

Parameter	<NR2> <NR1> CONSt KEEp SWEEp <NR2> <NR1> CONSt KEEp SWEEp <NR2> <NR1> CONSt KEEp SWEEp Waveform <NR2>	ACV setting ACV mode: Constant(0) Keep(1) Sweep(2) DCV. Not applicable. This parameter will be ignored. DCV mode: Constant(0) Keep(1) Sweep(2) Frequency Frequency mode: Constant(0) Keep(1) Sweep(2) ARB1 ARB2 ARB3 ARB4 ... ARB13 ARB14 ARB15 ARB16 SIN SQU TRI ARB17 ARB18 ARB19 ARB20 ... ARB250 ARB251 ARB252 ARB253 Phase angle. (L1 phase Fixed to 0.)
-----------	--	--

Return parameter <NR2>,<NR1> | CONSt | KEEp | SWEEp,<NR2>,<NR1> | CONSt | KEEp | SWEEp,<NR2>,<NR1> | CONSt | KEEp | SWEEp,ARB1 | ARB2 | ARB3 | ARB4 | ... | ARB13 | ARB14 | ARB15 | ARB16 | SIN | SQU | TRI | ARB17 | ARB18 | ARB19 | ARB20 | ... | ARB250 | ARB251 | ARB252 | ARB253
Returns the step parameters in the following order:
ACV, ACV mode, DCV, DCV mode, frequency, frequency mode, wave, phase.

Example :SEQ:SPAR?
+0.0,CONST,+0.0,CONST,+50.00,CONST,SIN,+0

Set →

→ Query

[:SOURce]:SEQuence:STEP

Description	Sets or queries the current step number. (Only Sequence Mode Active)	
Syntax	[:SOURce]:SEQuence:STEP {<NR1> MINimum MAXimum}	
Query Syntax	[:SOURce]:SEQuence:STEP? [MINimum MAXimum]	
Parameter/Return parameter	<NR1>	Step number
	MINimum	Minimum step number
	MAXimum	Maximum step number
Example	:SEQ:STEP 1 Sets the step number to 1.	

[:SOURce]:SEQuence:CONDition → Query

Description	Returns the sequence status.(Only Sequence Mode Active)
-------------	---

Query Syntax	[:SOURce]:SEQuence:CONDition?
--------------	-------------------------------

Return parameter	<NR1>	Current sequence status	0 (Idle mode)
			1 (Run mode)
			2 (Hold mode)

Example	:SEQ:COND? 1
---------	-----------------

:TRIGger:SEQuence:SElected:EXECute Set →

Description	Sets to execute actions for sequence mode. (Only Sequence Mode Active)
-------------	--

Syntax	:TRIGger:SEQuence:SElected:EXECute {STOP START HOLD BRAN1 BRAN2}
--------	---

Parameter	STOP	Stops sequence execution
	START	Starts sequence execution
	HOLD	Holds sequence execution
	BRAN1	Jumps to Branch 1 execution
	BRAN2	Jumps to Branch 2 execution

Example	TRIG:SEQ:SEL:EXEC STAR Starts sequence execution.
---------	--

Simulate Commands

[:SOURce]:SIMulation:CONDition	149
[:SOURce]:SIMulation:ABNormal:CODE	149
[:SOURce]:SIMulation:ABNormal:FREQuency	150
[:SOURce]:SIMulation:ABNormal:PHASe	
:STARt:ENABle.....	150
[:SOURce]:SIMulation:ABNormal:PHASe	
:STARt[:IMMediate]	151
[:SOURce]:SIMulation:ABNormal:PHASe	
:STOP:ENABle	151
[:SOURce]:SIMulation:ABNormal:PHASe	
:STOP[:IMMediate]	152
[:SOURce]:SIMulation:ABNormal:TIME	152
[:SOURce]:SIMulation:ABNormal:VOLTage	153
[:SOURce]:SIMulation:CSTep.....	153
[:SOURce]:SIMulation:CTIME	154
[:SOURce]:SIMulation:CREPeat:COUNt?	154
[:SOURce]:SIMulation:INITial:CODE	155
[:SOURce]:SIMulation:INITial:FREQuency	155
[:SOURce]:SIMulation:INITial:PHASe:STARt:ENABle	
e	156
[:SOURce]:SIMulation:INITial:PHASe:STARt[:IMMediate]	
.....	156
[:SOURce]:SIMulation:INITial:PHASe:STOP:ENABle	
.....	157
[:SOURce]:SIMulation:INITial:PHASe:STOP[:IMMediate]	
.....	157
[:SOURce]:SIMulation:INITial:VOLTage	158
[:SOURce]:SIMulation:NORMal<1 2>:CODE.....	158
[:SOURce]:SIMulation:NORMal 1:FREQuency	159
[:SOURce]:SIMulation:NORMal<1 2>	
:PHASe:STARt:ENABle.....	159
[:SOURce]:SIMulation:NORMal<1 2>	
:PHASe:STARt[:IMMediate].....	160
[:SOURce]:SIMulation:NORMal<1 2>	
:PHASe:STOP:ENABle	160
[:SOURce]:SIMulation:NORMal<1 2>	

:PHASe:STOP[:IMMediate].....161
 [:SOURce]:SIMulation:NORMal<1 | 2>:TIME.....161
 [:SOURce]:SIMulation:NORMal 1:VOLTage162
 [:SOURce]:SIMulation:REPeat:COUNt162
 [:SOURce]:SIMulation:REPeat:ENABle.....163
 [:SOURce]:SIMulation:TRANsition<1 | 2>:TIME ...163
 [:SOURce]:SIMulation:TRANsition<1 | 2>:CODE .164
 :TRIGger:SIMulation:SELEcted:EXECute164

[:SOURce]:SIMulation:CONDition → **Query**

Description	Returns the simulation status. (Only Simulation Mode Active)		
Query Syntax	[:SOURce]:SIMulation:CONDition?		
Return parameter	<NR1>	Current simulation status	0 (Idle mode) 1 (Run mode) 2 (Hold mode)
Example	:SIM:COND? 1		

[:SOURce]:SIMulation:ABNormal:CODE → **Set** → **Query**

Description	Sets the external trigger output for the abnormal step parameter. This option is only applicable when in the Simulation mode. (Only Simulation Mode Active)		
Syntax	[:SOURce]:SIMulation:ABNormal:CODE {<NR1> MINimum MAXimum}		
Query Syntax	[:SOURce]:SIMulation:ABNormal:CODE? [MINimum MAXimum]		
Parameter/Return parameter	<NR1> MINimum MAXimum	External trigger output, 0=LL, 1=LH, 2=HL, 3=HH. 0 (LL) 3 (HH)	
Example	SIM:ABN:CODE 1		

`[:SOURce]:SIMulation:ABNormal` (Set) →
`:FREQuency` → (Query)

Description	Sets or queries the frequency of the abnormal step of the simulation mode. (Only Simulation Mode Active)	
Syntax	[:SOURce]:SIMulation:ABNormal:FREQuency {<NR2> MINimum MAXimum}	
Query Syntax	[:SOURce]:SIMulation:ABNormal:FREQuency? [MINimum MAXimum]	
Parameter/Return parameter	<NR2> MINimum MAXimum	Frequency of abnormal step Minimum frequency Maximum frequency
Example	:SIM:ABN:FREQ 55 Sets the frequency to 55Hz.	

`[:SOURce]:SIMulation:ABNormal:PHASe` (Set) →
`:STARt:ENABle` → (Query)

Description	Enables/Disables (Fixed/Free) the ON Phs parameter of the abnormal step for the Simulation mode. (Only Simulation Mode Active)	
Syntax	[:SOURce]:SIMulation:ABNormal:PHASe:STARt:ENABle {<bool> OFF ON FREE FIXED}	
Query Syntax	[:SOURce]:SIMulation:ABNormal:PHASe:STARt:ENABle?	
Parameter/Return parameter	OFF 0 FREE ON 1 FIXED	Disabled Enabled
Example	:SIM:ABN:PHAS:STAR:ENAB 1 Enable the ON Phs.	

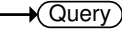
`[:SOURce]:SIMulation:ABNormal:PHASe` 
`:STOP[:IMMEDIATE]` 

Description	Sets or queries the OFF Phs parameter of the abnormal step for the Simulation mode. (Only Simulation Mode Active)						
Note:	Sets the off phase of the waveform after the output has been turned off.						
Syntax	<code>[:SOURce]:SIMulation:ABNormal:PHASe:STOP[:IMMEDIATE] {<NR2> MINimum MAXimum}</code>						
Query Syntax	<code>[:SOURce]:SIMulation:ABNormal:PHASe:STOP[:IMMEDIATE]? [MINimum MAXimum]</code>						
Parameter/Return parameter	<table border="1"> <tr> <td><NR2></td> <td>OFF Phs (Stop phase)</td> </tr> <tr> <td>MINimum</td> <td>0</td> </tr> <tr> <td>MAXimum</td> <td>359.9</td> </tr> </table>	<NR2>	OFF Phs (Stop phase)	MINimum	0	MAXimum	359.9
<NR2>	OFF Phs (Stop phase)						
MINimum	0						
MAXimum	359.9						
Example	<code>:SIM:ABN:PHAS:STOP 0</code> Sets OFF Phs to 0.						

`[:SOURce]:SIMulation:ABNormal:TIME` 

Description	Sets or queries the Time parameter of the abnormal step for the Simulation mode. (Only Simulation Mode Active)						
Syntax	<code>[:SOURce]:SIMulation:ABNormal:TIME {<NR2> MINimum MAXimum}</code>						
Query Syntax	<code>[:SOURce]:SIMulation:ABNormal:TIME? [MINimum MAXimum]</code>						
Parameter/Return parameter	<table border="1"> <tr> <td><NR2></td> <td>Time of the abnormal step in seconds</td> </tr> <tr> <td>MINimum</td> <td>0.0001</td> </tr> <tr> <td>MAXimum</td> <td>999.9999s</td> </tr> </table>	<NR2>	Time of the abnormal step in seconds	MINimum	0.0001	MAXimum	999.9999s
<NR2>	Time of the abnormal step in seconds						
MINimum	0.0001						
MAXimum	999.9999s						
Example	<code>:SIM:ABN:TIME 1</code> Sets the abnormal step time to 1 second.						

[[:SOURce]:SIMulation:ABNormal:VOLTage (Set) →
→ (Query)

Description	Sets or queries the Vset parameter of the abnormal step for the Simulation mode. (Only Simulation Mode Active)	
Syntax	[:SOURce]:SIMulation:ABNormal:VOLTage {<NR2> MINimum MAXimum}	
Query Syntax	[:SOURce]:SIMulation:ABNormal:VOLTage? [MINimum MAXimum]	
Parameter/Return parameter	<NR2> MINimum MAXimum	Voltage of the abnormal step. Minimum settable voltage Maximum settable voltage
Example	:SIM:ABN:VOLT MAX Sets the abnormal step voltage to the maximum.	

[[:SOURce]:SIMulation:CSTep → (Query)

Description	Returns the currently running step. (Only Simulation Mode Active)	
Query Syntax	[:SOURce]:SIMulation:CSTep?	
Return parameter	<NR1>	Current step +0 = Initial step +1 = Normal1 step +2 = Transition1 step +3 = Abnormal step +4 = Transition2 step +5 = Normal2 step
Example	:SIM:CSTep? +1	

[:SOURce]:SIMulation:CTIME

→ Query

Description	Returns the currently running step number and elapsed time.(Only Simulation Mode Active)
Query Syntax	[:SOURce]:SIMulation:CTIME?
Return parameter	<NR1> Current step number,current elapsed hours,current elapsed minutes, current elapsed second +0 = Initial step +1 = Normal1 step +2 = Transition1 step +3 = Abnormal step +4 = Transition2 step +5 = Normal2 step
Example	:SIM:CTIME? +1,+0,+0,+18

[:SOURce]:SIMulation:CREPeat:COUNT?

→ Query

Description	Returns the currently running step and jump count. If the jump to function is turned off, the returned information is "-1". If jump count is set to infinity, the returned information is "Inf".(Only Simulation Mode Active)
Query Syntax	[:SOURce]:SIMulation:CREPeat:COUNT?
Return parameter	<NR1> Current step,current repeat count +0 = Initial step +1 = Normal1 step +2 = Transition1 step +3 = Abnormal step +4 = Transition2 step +5 = Normal2 step
Example	:SIM:CREPeat:COUNT? +1,+1

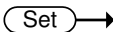
`[:SOURce]:SIMulation:INITial:CODE`



Description	Sets the external trigger output for the initial step parameter. This option is only applicable when in the Simulation mode. (Only Simulation Mode Active)	
Syntax	[:SOURce]:SIMulation:INITial:CODE {<NR1> MINimum MAXimum}	
Query Syntax	[:SOURce]:SIMulation:INITial:CODE? [MINimum MAXimum]	
Parameter/Return parameter	<NR1>	0=LL, 1=LH, 2=HL, 3=HH MINimum 0 (LL) MAXimum 3 (HH)
Example	SIM:INIT:CODE 1	

`[:SOURce]:SIMulation:INITial:FREQuency`



Description	Sets or queries the frequency of the initial step of the simulation mode. (Only Simulation Mode Active)	
Syntax	[:SOURce]:SIMulation:INITial:FREQuency {<NR2> MINimum MAXimum}	
Query Syntax	[:SOURce]:SIMulation:INITial:FREQuency? [MINimum MAXimum]	
Parameter/Return parameter	<NR2>	Frequency of initial step MINimum Minimum frequency MAXimum Maximum frequency
Example	:SIM:INIT:FREQ 60 Sets the frequency of the initial step to 60Hz.	

`[:SOURce]:SIMulation:INITial:PHASe:STARt` Set →
`:ENABle` Query

Description	Enables/Disables (Fixed/Free) the ON Phs parameter of the initial step for the Simulation mode. (Only Simulation Mode Active)	
Syntax	[:SOURce]:SIMulation:INITial:PHASe:STARt:ENABle {<bool> OFF ON FREE FIXED}	
Query Syntax	[:SOURce]:SIMulation:INITial:PHASe:STARt:ENABle?	
Parameter/Return parameter	OFF 0 FREE ON 1 FIXED	Disabled Enabled
Example	:SIM:INIT:PHAS:STAR:ENAB 1 Enable the ON Phs.	

`[:SOURce]:SIMulation:INITial:PHASe:STARt` Set →
`[:IMMEDIATE]` Query

Description	Sets or queries the ON Phs parameter of the initial step for the Simulation mode. (Only Simulation Mode Active)	
Syntax	[:SOURce]:SIMulation:INITial:PHASe:STARt [:IMMEDIATE] {<NR2> MINimum MAXimum}	
Query Syntax	[:SOURce]:SIMulation:INITial:PHASe:STARt [:IMMEDIATE]? [MINimum MAXimum]	
Parameter/Return parameter	<NR2> MINimum MAXimum	ON Phs (start phase) 0 359.9
Example	:SIM:INIT:PHAS:STAR 0 Sets ON Phs to 0.	

`[[:SOURce]:SIMulation:INITial:PHASe:STOP :ENABle` (Set) →
→ (Query)

Description	Enables/Disables (Fixed/Free) the OFF Phs parameter of the initial step for the Simulation mode. (Only Simulation Mode Active)	
Syntax	<code>[[:SOURce]:SIMulation:INITial:PHASe:STOP:ENABle {<bool> OFF ON FREE FIXED }</code>	
Query Syntax	<code>[[:SOURce]:SIMulation:INITial:PHASe:STOP:ENABle?</code>	
Parameter/Return parameter	OFF 0 FREE ON 1 FIXED	Disabled Enabled
Example	<code>:SIM:INIT:PHAS:STOP:ENAB 1</code> Enable the OFF Phs.	

`[[:SOURce]:SIMulation:INITial:PHASe:STOP [:IMMEDIATE]` (Set) →
→ (Query)

Description	Sets or queries the OFF Phs parameter of the initial step for the Simulation mode. (Only Simulation Mode Active)	
Note:	Sets the off phase of the waveform after the output has been turned off.	
Syntax	<code>[[:SOURce]:SIMulation:INITial:PHASe:STOP [:IMMEDIATE] {<NR2> MINimum MAXimum}</code>	
Query Syntax	<code>[[:SOURce]:SIMulation:INITial:PHASe:STOP [:IMMEDIATE]? [MINimum MAXimum]</code>	
Parameter/Return parameter	<NR2> MINimum MAXimum	OFF Phs (Stop phase) 0 359.9
Example	<code>:SIM:INIT:PHAS:STOP 0</code> Sets OFF Phs to 0.	

`[:SOURce]:SIMulation:INITial:VOLTage`
 →
 →

Description	Sets or queries the Vset parameter of the initial step for the Simulation mode. (Only Simulation Mode Active)	
Syntax	[:SOURce]:SIMulation:INITial:VOLTage {<NR2> MINimum MAXimum}	
Query Syntax	[:SOURce]:SIMulation:INITial:VOLTage? [MINimum MAXimum]	
Parameter/Return parameter	<NR2>	Voltage of the initial step.
	MINimum	Minimum settable voltage
	MAXimum	Maximum settable voltage
Example	:SIM:INIT:VOLT MAX Sets the initial step voltage to the maximum.	

`[:SOURce]:SIMulation:NORMal<1|2>:CODE`
 →
 →

Description	Sets the external trigger output for the normal 1 or normal 2 step parameter. This option is only applicable when in the Simulation mode. (Only Simulation Mode Active)	
Syntax	[:SOURce]:SIMulation:NORMal<1 2>:CODE {<NR1> MINimum MAXimum}	
Query Syntax	[:SOURce]:SIMulation:NORMal<1 2>:CODE? [MINimum MAXimum]	
Parameter/Return parameter	<NR1>	0=LL, 1=LH, 2=HL, 3=HH
	MINimum	0 (LL)
	MAXimum	3 (HH)
Example	SIM:NORM1:CODE 1	

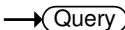
`[[:SOURce]:SIMulation:NORMal 1
:FREQuency`



Description Sets or queries the frequency of the normal1 step of the simulation mode. (Only Simulation Mode Active)

Syntax `[[:SOURce]:SIMulation:NORMal 1:FREQuency {<NR2>|MINimum|MAXimum}`

Query Syntax `[[:SOURce]:SIMulation:NORMal 1:FREQuency? [MINimum|MAXimum]`

Parameter/Return parameter	1	Normal 1
	<NR2>	Frequency of abnormal step
	MINimum	Minimum frequency
	MAXimum	Maximum frequency

Example `:SIM:NORM1:FREQ 60`
Sets the frequency to 60Hz.

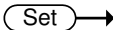
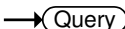
`[[:SOURce]:SIMulation:NORMal<1|2>
:PHASe:STARt:ENABle`



Description Enables/Disables (Fixed/Free) the ON Phs parameter of the normal1 or normal2 step for the Simulation mode. (Only Simulation Mode Active)

Syntax `[[:SOURce]:SIMulation:NORMal<1|2>:PHASe:STARt:ENABle { <bool>|OFF|ON|FREE|FIXED}`

Query Syntax `[[:SOURce]:SIMulation:NORMal<1|2>:PHASe:STARt:ENABle?`

Parameter/Return parameter	<1 2>	Normal 1 or Normal 2
	OFF 0 FREE	Disabled
	ON 1 FIXED	Enabled

Example `:SIM:NORM1:PHAS:STAR:ENAB 1`
Enable the ON Phs.

`[:SOURce]:SIMulation:NORMal<1|2>` (Set) →
`:PHASe:START[:IMMediate]` → (Query)

Description	Sets or queries the ON Phs parameter of the normal1 or normal2 step for the Simulation mode. (Only Simulation Mode Active)	
Syntax	[:SOURce]:SIMulation:NORMal<1 2>:PHASe:START[:IMMediate] {<NR2> MINimum MAXimum}	
Query Syntax	[:SOURce]:SIMulation:NORMal<1 2>:PHASe:START[:IMMediate]? [MINimum MAXimum]	
Parameter/Return parameter	<1 2>	Normal 1 or Normal 2
	<NR2>	ON Phs (start phase)
	MINimum	0
	MAXimum	359.9
Example	:SIM:NORM1:PHAS:STAR 0 Sets ON Phs to 0.	

`[:SOURce]:SIMulation:NORMal<1|2>` (Set) →
`:PHASe:STOP:ENABLE` → (Query)

Description	Enables/Disables (Fixed/Free) the OFF Phs parameter of the normal1 or normal2 step for the Simulation mode. (Only Simulation Mode Active)	
Syntax	[:SOURce]:SIMulation:NORMal<1 2>:PHASe:STOP:ENABLE {<bool> OFF ON FREE FIXED}	
Query Syntax	[:SOURce]:SIMulation:NORMal<1 2>:PHASe:STOP:ENABLE?	
Parameter/Return parameter	<1 2>	Normal 1 or Normal 2
	OFF 0 FREE	Disabled
	ON 1 FIXED	Enabled
Example	:SIM:NORM1:PHAS:STOP:ENAB 1 Enable the OFF Phs.	

`[[:SOURce]:SIMulation:NORMal<1|2>:PHASe:STOP[:IMMEDIATE]`  

Description	Sets or queries the OFF Phs parameter of the normal1 or normal2 step for the Simulation mode. (Only Simulation Mode Active)	
Note:	Sets the off phase of the waveform after the output has been turned off.	
Syntax	[:SOURce]:SIMulation:NORMal<1 2>:PHASe:STOP[:IMMEDIATE] {<NR2> MINimum MAXimum}	
Query Syntax	[:SOURce]:SIMulation:NORMal<1 2>:PHASe:STOP[:IMMEDIATE]? [MINimum MAXimum]	
Parameter/Return parameter	<1 2> <NR2> MINimum MAXimum	Normal 1 or Normal 2 OFF Phs (Stop phase) 0 359.9
Example	:SIM:NORM1:PHAS:STOP 0 Sets OFF Phs to 0.	

`[[:SOURce]:SIMulation:NORMal<1|2>:TIME`  

Description	Sets or queries the Time parameter of the normal1 or normal2 step for the Simulation mode. (Only Simulation Mode Active)	
Syntax	[:SOURce]:SIMulation:NORMal<1 2>:TIME {<NR2> MINimum MAXimum}	
Query Syntax	[:SOURce]:SIMulation:NORMal<1 2>:TIME? [MINimum MAXimum]	
Parameter/Return parameter	<1 2> <NR2> MINimum MAXimum	Normal 1 or Normal 2 Time of the step in seconds 0.0001 999.9999s
Example	:SIM:NORM1:TIME 1 Sets the step time to 1 second.	

Set →
 → Query

[[:SOURce]:SIMulation:NORMal 1:VOLTage

Description	Sets or queries the Vset parameter of the normal1 step for the Simulation mode. (Only Simulation Mode Active)	
Syntax	[:SOURce]:SIMulation:NORMal 1:VOLTage {<NR2> MINimum MAXimum}	
Query Syntax	[:SOURce]:SIMulation:NORMal 1:VOLTage? [MINimum MAXimum]	
Parameter/Return parameter	1 <NR2> MINimum MAXimum	Normal 1 Voltage of the abnormal step. Minimum settable voltage Maximum settable voltage
Example	:SIM:NORM1:VOLT MAX Sets the normal1 step voltage to the maximum.	

Set →
 → Query

[[:SOURce]:SIMulation:REPeat:COUNt

Description	Sets or queries the repeat count for the Simulation mode. (Only Simulation Mode Active)	
Syntax	[:SOURce]:SIMulation:REPeat:COUNt {<NR1> MINimum MAXimum}	
Query Syntax	[:SOURce]:SIMulation:REPeat:COUNt? [MINimum MAXimum]	
Parameter/Return parameter	<NR1> MINimum MAXimum	0 ~ 9999 (0 = infinite loop) 0 9999
Example	:SIM:REP:COUN 1 Sets the repeat count to 1.	

`[:SOURce]:SIMulation:REPeat:ENABLE`



Description	Turns the repeat function on or off for the Simulation mode. (Only Simulation Mode Active)	
Syntax	[:SOURce]:SIMulation:REPeat:ENABLE {<bool> OFF ON}	
Query Syntax	[:SOURce]:SIMulation:REPeat:ENABLE?	
Parameter/Return parameter	OFF 0 ON 1	Disabled Enabled
Example	:SIM:REP:ENAB 1 Enables the repeat function.	

`[:SOURce]:SIMulation:TRANSition<1|2>:TIME`



Description	Sets or queries the Time parameter of the transition step for the Simulation mode. (Only Simulation Mode Active)	
Syntax	[:SOURce]:SIMulation:TRANSition<1 2>:TIME {<NR2> MINimum MAXimum}	
Query Syntax	[:SOURce]:SIMulation:TRANSition<1 2>:TIME? [MINimum MAXimum]	
Parameter/Return parameter	<NR2> MINimum MAXimum	Time of the step in seconds 0 999.9999s
Example	:SIM:TRAN1:TIME 1 Sets the step time to 1 second.	

`[:SOURce]:SIMulation:TRANsition<1|2>:CODE` Set →
`DE` Query

Description	Sets the external trigger output for the transition step parameter. This option is only applicable when in the Simulation mode. (Only Simulation Mode Active)	
Syntax	[:SOURce]:SIMulation:TRANsition<1 2>:CODE {<NR1> MINimum MAXimum}	
Query Syntax	[:SOURce]:SIMulation:TRANsition<1 2>:CODE? [MINimum MAXimum]	
Parameter/Return parameter	<NR1> MINimum MAXimum	0=LL, 1=LH, 2=HL, 3=HH 0 (LL) 3 (HH)
Example	SIM:TRAN1:CODE 1	

`:TRIGger:SIMulation:SElected:EXECute` Set →

Description	Sets to execute actions for simulate mode. (Only Simulation Mode Active)	
Syntax	:TRIGger:SIMulation:SElected:EXECute {STOP START HOLD}	
Parameter	STOP START HOLD	Stops simulate execution Starts simulate execution Holds simulate execution
Example	TRIG:SIM:SEL:EXEC STAR Starts simulate execution.	

Input Subsystem Command

:INPut:SOURce	165
:INPut:GAIN.....	165
:INPut:SYNC:SOURce.....	166

:INPut:SOURce (Set) →
→ (Query)

Description Sets or queries state of source. (Only AC+DC-EXT or AC-EXT or AC+DC-ADD or AC-ADD or AC-VAC Active)

Syntax :INPut:SOURce {<NR1>|L1EXT|L2EXT|L3EXT}

Query Syntax :INPut:SOURce?

Parameter/Return parameter	<NR1> L1EXT 0 L2EXT 1 L3EXT 2	L1EXT (0) L2EXT (1) L3EXT(2) L1 EXT source L2 EXT source L3 EXT source
-----------------------------------	--	---

Example :INP:SOUR?

L1EXT

Returns the state of source as L1EXT.

:INPut:GAIN (Set) →
→ (Query)

Description Sets or queries the input gain value. (Only AC+DC-EXT or AC-EXT or AC+DC-ADD or AC-ADD or AC-VCA Active)

Syntax :INPut:GAIN {<NR2>(V)|MINimum|MAXimum}

Query Syntax :INPut:GAIN? [MINimum|MAXimum]

Parameter/Return parameter	<NR2> MINimum MAXimum	Input gain value Minimum input gain value Maximum input gain value
-----------------------------------	-----------------------------	--

Example :INP:GAIN?
 +150.0000
 Returns the input gain value as 150.0.

Set →

:INPut:SYNC:SOURce

→ Query

Description Sets or queries state of sync source. (Only AC+DC-sync or AC-sync Active)

Syntax :INPut:SYNC:SOURce
 {<NR1>|L1Line|L2Line|L3Line|EXT}

Query Syntax :INPut:SYNC:SOURce?

Parameter/	<NR1>	L1Line(0) L2Line(1) L3Line(2) EXT(3)
Return parameter	L1Line0	L1 LINE sync source
	L2Line1	L2 LINE sync source
	L3Line2	L3 LINE sync source
	EXT 3	EXT sync source

Example :INP:SYNC:SOUR?
 EXT
 Returns the state of sync source as EXT.

Display Command

```
:DISPlay[:WINDow]:DESIgn:MODE.....167
:DISPlay[:WINDow]:MEASure:SOURce<1|2|3|4>.167
```

:DISPlay[:WINDow]:DESIgn:MODE Set →

Description	Sets three display mode.	
Syntax	:DISPlay[:WINDow]:DESIgn:MODE{NORMal TOTal SIMPlE}	
Parameter	NORMal	Configure setup and Measurement.
	TOTal	Configure setup and Measurement include total information.
	SIMPlE	All measurement times.
Example	:DISP:DES:MODE NORM Sets standard normal display.	

:DISPlay[:WINDow]:MEASure:SOURce<1|2|3|4> Set →

Description	Sets standard normal display to measurement items 1 – 4.	
Syntax	:DISPlay[:WINDow]:MEASure:SOURce<1 4>{ VRMS VAVG VMAX VMIN VPKH IRMS IAVG IMAX IMIN IPKH RPOWer SPOWer QPOWer FREQuency PFACTOR CFACtor THDV THDI LRMS LAVG LMAX LMIN}	
Parameter	Item 1	VRMS, VAVG, VMAX, VMIN, VPKH, LRMS*1, LAVG*1, LMAX*1, LMIN*1, RPOWer, SPOWer*1, QPOWer*1, THDV*2
	Item 2	IRMS, IAVG, IMAX, IMIN, IPKH, PFACTOR*1, CFACtor*1, THDI*2
	Item 3	RPOWer, SPOWer*1, QPOWer*1, IPKH, PFACTOR*1, CFACtor*1, FREQuency*3

Item 4	LRMS*1, LAVG*1, LMAX*1, LMIN*1, IRMS*4, IAVG*4, IMAX*4, IMIN*4, RPOWer, IPKH*4, SPOWer*1, QPOWer*1, PFACTOR*1, CFACTOR*1
Note	*1: Not available for DC-INT *2: Available for AC-INT only *3: Available for AC+DC-Sync & AC-Sync only *4: Available for DC-INT only

Example :DISP:MEAS:SOUR1 VRMS
Sets measurement source 1 VRMS display.

Status Register Overview

To program the ASR power supply effectively, the Status registers need to be understood. This chapter explains in detail how the Status registers are used and how to configure them.

Introduction to the Status Registers	169
The Status Registers	170
Questionable Status Register Group	171
Operation Status Register Group	174
Warning Status Register Group	176
System Lock Status Register Group	179
Standard Event Status Register Group	181
Status Byte Register & Service Request Enable Register	183

Introduction to the Status Registers

Overview

The status registers are used to determine the status of the power supply. The status registers maintain the status of the protection conditions, operation conditions and instrument errors.

The ASR Series have a number of register groups:

- Questionable Status Register Group
- Standard Event Status Register Group
- Operation Status Register Group
- Warning Status Register Group
- System Lock Status Register Group
- Status Byte Register
- Service Request Enable Register
- Service Request Generation
- Error Queue
- Output Buffer

The diagram below shows the structure of the Status registers.

The Status Registers

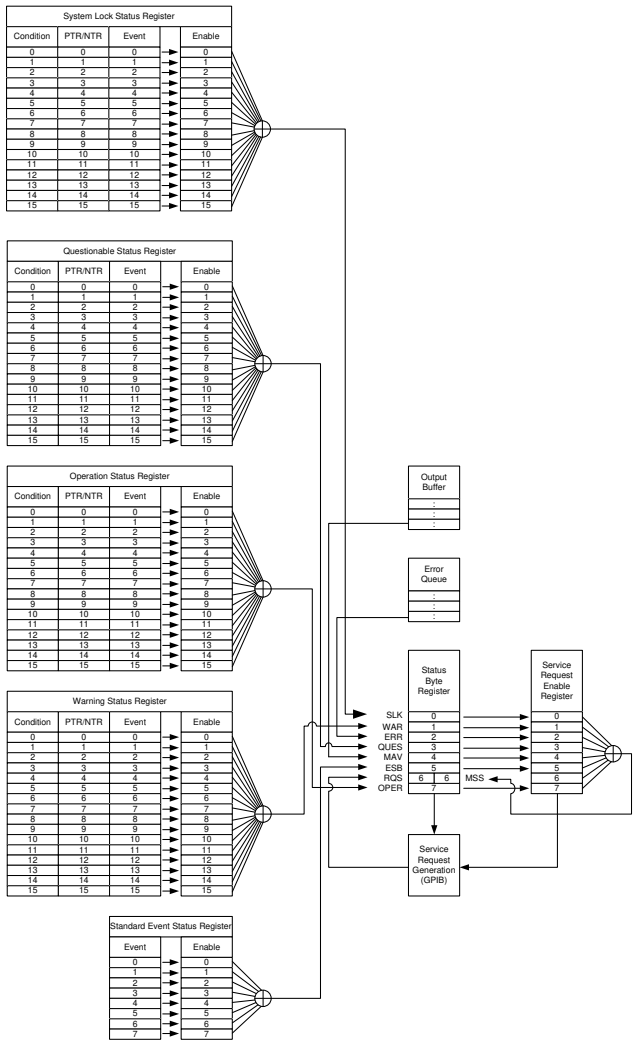

Questionable Status Register Group

Overview

The Questionable Status Register Group indicates if any protection modes or limits have been tripped.

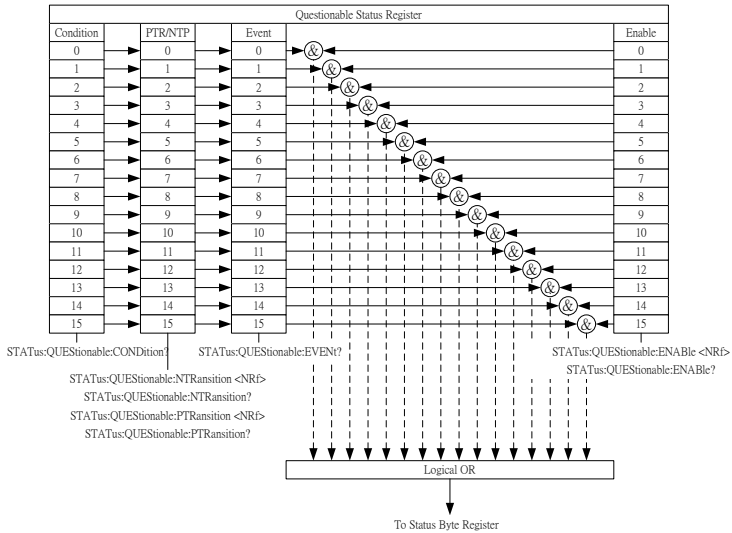

Bit Summary

Event	Bit #	Bit Weight
Output Overvoltage	0	1
Over internal maximum voltage (110% of rating voltage).		
Over Irms Current	1	2
Output current RMS value is excessive		
DCAC Power Unit Error	3	8
Internal DCAC power unit function error.		

DCDC Power Unit Error Internal DCDC power unit function error.	4	16
Output Short Call attention to output terminal short status	5	32
Over Ipeak+ Current or Over Ipeak- Current Positive/Negative output current peak value is excessive.	6	64
Fan Failure Fan failure. Contact service center.	7	128
Calibration Data Error The calibration data is abnormal or out of allowance range.	8	256
Output Over-Power Over internal power stage maximum power (110% of rating power)	9	512
IPK Limit The peak current limiter is activated.	10	1024
Remote Sensing Voltage Out of Range The Sensing voltage limiter is activated.	11	2048
IRMS Limit The RMS current limiter is activated.	12	4096
Always 0	15	32768

Condition Register	The Questionable Status Condition Register indicates the status of the power supply. If a bit is set in the Condition register, it indicates that the event is true. Reading the condition register does not change the state of the condition register.
PTR/NTR Filters	The PTR/NTR (Positive/Negative transition) register determines the type of transition conditions that will set the corresponding bit in the Event Registers. Use the Positive transition filter to view events that change from false to positive, and use the negative transition filter to view events that change from positive to negative.
	Positive Transition 0→1
	Negative Transition 1→0
Event Register	The PTR/NTR Register will dictate the type of transition conditions will set the corresponding bits in the Event Register. If the Event Register is read, it will be cleared to 0.
Enable Register	The Enable register determines which Events in the Event Register will be used to set the QUES bit in the Status Byte Register.

Operation Status Register Group

Overview

The Operation Status Register Group indicates the operating status of the power supply.

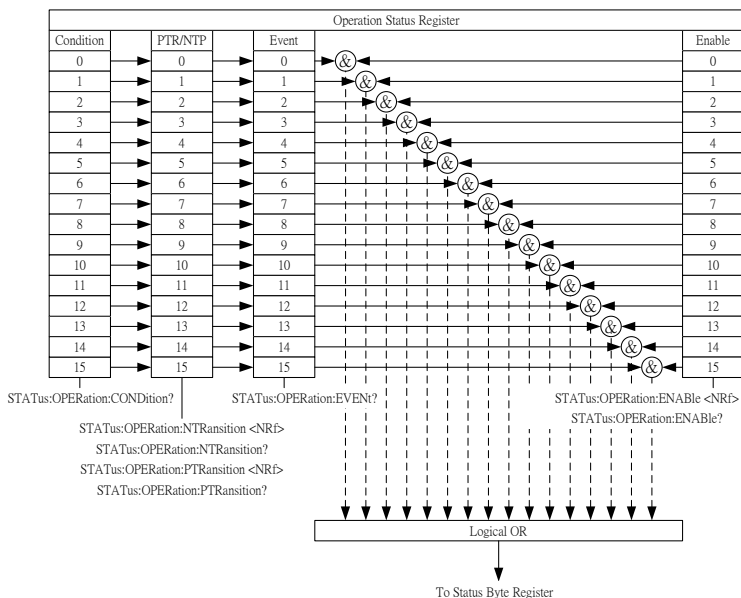

Bit Summary

Event	Bit #	Bit Weight
Busy Status	1	2
LOCK status (SYNC) status	8	256
Hold Status (Sequence)	12	4096
Run Status (Sequence)	14	16384
Always 0	15	32768

Condition Register	The Operation Status Condition Register indicates the operating status of the power supply. If a bit is set in the Condition register, it indicates that the event is true. Reading the condition register does not change the state of the condition register.
PTR/NTR Filters	The PTR/NTR (Positive/Negative transition) register determines the type of transition conditions that will set the corresponding bit in the Event Registers. Use the Positive transition filter to view events that change from false to positive, and use the negative transition filter to view events that change from positive to negative.
	Positive Transition 0→1
	Negative Transition 1→0
Event Register	The PTR/NTR Register will dictate the type of transition conditions will set the corresponding bits in the Event Register. If the Event Register is read, it will be cleared to 0.
Enable Register	The Enable register determines which registered Events in the Event Register will be used to set the OPER bit in the Status Byte Register.

Warning Status Register Group

Overview

The Warning Status Register Group is a secondary protection status register for the supply output.

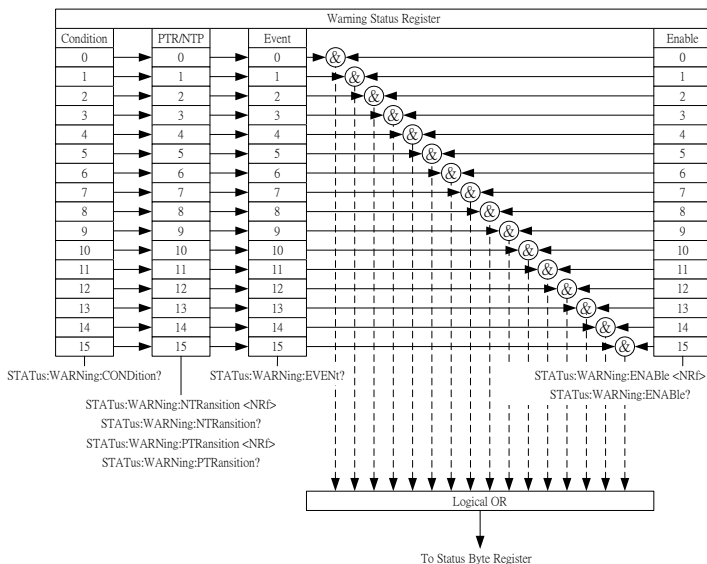

Bit Summary

Event	Bit #	Bit Weight
Output Overvoltage	0	1
Over internal maximum voltage (110% of rating voltage).		
Over Irms Current	1	2
Output current RMS value is excessive		

Over Ipeak+ Current or Over Ipeak- Current Positive/Negative output current peak value is excessive.	3	8
DCAC Power Unit Error Internal DCAC power unit function error.	5	32
DCDC Power Unit Error Internal DCDC power unit function error.	6	64
External Sync Frequency Error The external synchronization signal input frequency is out of the allowance range.	7	128
Sensing Voltage Error Remote sense connection wire is abnormal or over maximum compensation voltage.	9	512
Over Irms Current Output current RMS value is excessive	10	1024
Over Ipeak+ Current or Over Ipeak- Current Positive/Negative output current peak value is excessive.	11	2048
Output Over-Power Over internal power stage maximum power (110% of rating power)	12	4096
IRMS Limit The RMS current limiter is activated.	13	8192

	IPK Limit	14	16384
	The peak current limiter is activated.		
	Always 0	15	32768
Condition Register	The System Lock Status Condition Register indicates the system lock status of the power supply. If a bit is set in the Condition register, it indicates that the event is true. Reading the condition register does not change the state of the condition register.		
PTR/NTR Filters	The PTR/NTR (Positive/Negative transition) register determines the type of transition conditions that will set the corresponding bit in the Event Registers. Use the Positive transition filter to view events that change from false to positive, and use the negative transition filter to view events that change from positive to negative.		
	Positive Transition	0→1	
	Negative Transition	1→0	
Event Register	The PTR/NTR Register will dictate the type of transition conditions will set the corresponding bits in the Event Register. If the Event Register is read, it will be cleared to 0.		
Enable Register	The Enable register determines which registered Events in the Event Register will be used to set the SLK bit in the Status Byte Register.		

System Lock Status Register Group

Overview

The System Lock Status Register Group indicates if system lock protection modes have been tripped.

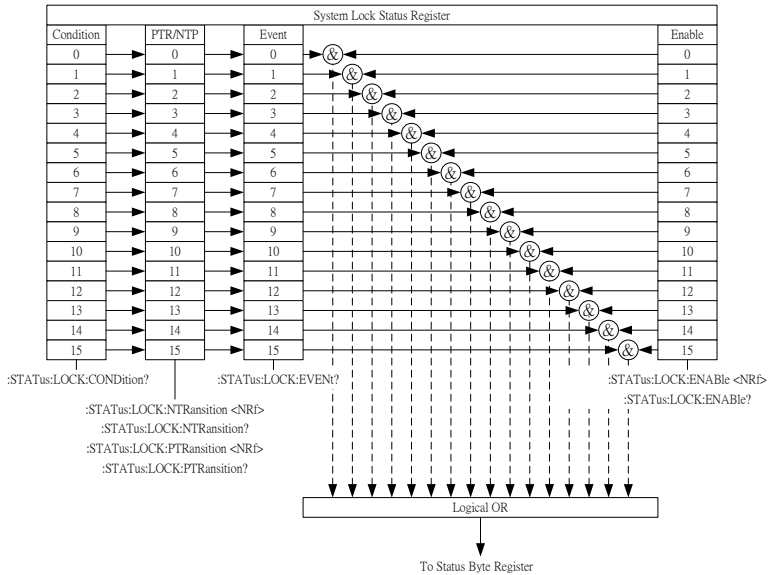

Bit Summary

Event	Bit #	Bit Weight
Power Input Anomaly	0	1
The power input voltage is insufficient or turning off main power switch. Check input power before rebooting the unit.		
Fan Failure	7	128
Fan failure. Contact service center.		
Startup Anomaly	8	256
Abnormal startup procedure.		

	PFC Power Unit Error	9	512
	Internal PFC power unit function error.		
Condition Register	The System Lock Status Condition Register indicates the system lock status of the power supply. If a bit is set in the Condition register, it indicates that the event is true. Reading the condition register does not change the state of the condition register.		
PTR/NTR Filters	The PTR/NTR (Positive/Negative transition) register determines the type of transition conditions that will set the corresponding bit in the Event Registers. Use the Positive transition filter to view events that change from false to positive, and use the negative transition filter to view events that change from positive to negative.		
	Positive Transition	0→1	
	Negative Transition	1→0	
Event Register	The PTR/NTR Register will dictate the type of transition conditions will set the corresponding bits in the Event Register. If the Event Register is read, it will be cleared to 0.		
Enable Register	The Enable register determines which registered Events in the Event Register will be used to set the SLK bit in the Status Byte Register.		

Standard Event Status Register Group

Overview

The Standard Event Status Register Group indicates if any errors have occurred. The bits of the Event register are set by the error event queue.

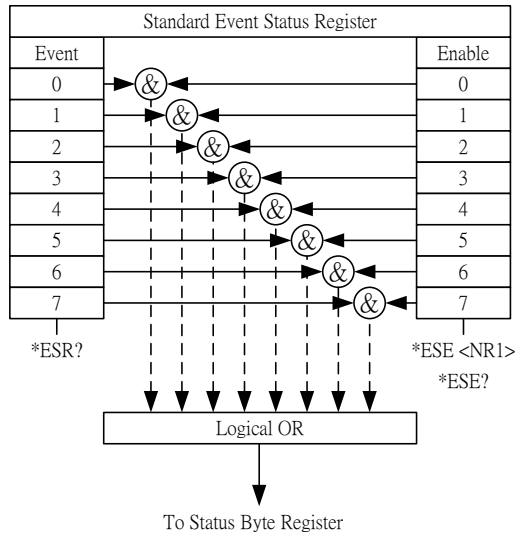

Bit Summary

Event	Bit #	Bit Weight
OPC (Operation complete)	0	1
The OCP bit is set when all selected pending operations are complete. This bit is set in response to the *OPC command.		
RQC (Request control)	1	2

	QUE (Query Error)	2	4
	The Query Error bit is set in response to an error reading the Output Queue. This can be caused by trying to read the Output Queue when there is no data present.		
	DDE (Device Dependent Error)	3	8
	Device specific error.		
	EXE (Execution Error)	4	16
	The EXE bit indicates an execution error due to one of the following: illegal command parameter, parameter out of range, invalid parameter, the command didn't execute due to an overriding operation condition.		
	CME (Command Error)	5	32
	The CME bit is set when a syntax error has occurred. The CME bit can also be set when a <GET> command is received within a program message.		
	URQ (User Request)	6	64
	PON (Power On)	7	128
	Indicates the power is turned on.		
Event Register	Any bits set in the event register indicate that an error has occurred. Reading the Event register will reset the register to 0.		
Enable Register	The Enable register determines which Events in the Event Register will be used to set the ESB bit in the Status Byte Register.		

Status Byte Register & Service Request Enable Register

Overview

The Status Byte register consolidates the status events of all the status registers. The Status Byte register can be read with the *STB? query and can be cleared with the *CLS command.

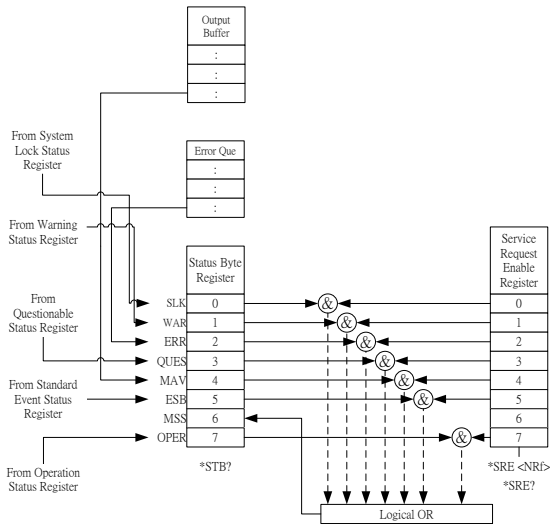

Bit Summary

Event	Bit #	Bit Weight
SLK(System Lock Status Register Summary)	0	1
WAR (Warning Status Register)	1	2
ERR (Error Queue not empty)	2	4
QUES (Questionable Status Register)	3	8
MAV (Message Available)	4	16
ESB(Standard Event Status Register Summary)	5	32

RQS / MSS(Reuest Service / Master Summary Status)	6	64
OPER (Operation Status Register)	7	128

Status Byte Register Any bits set in the Status byte register acts as a summary register for all the three other status registers and indicates if there is a service request, an error in the Error Queue or data in the Output Queue. Reading the Status Byte register will reset the register to 0.

Service Request Enable Register The Service Request Enable Register controls which bits in the Status Byte Register are able to generate service requests.

Error List

Command Errors.....	185
Execution Errors.....	189
Device Specific Errors.....	191
Query Errors.....	192

Command Errors

Overview

An <error/event number> in the range [-199 , -100] indicates that an IEEE 488.2 syntax error has been detected by the instrument's parser. The occurrence of any error in this class shall cause the command error bit (bit 5) in the event status register (IEEE 488.2, section 11.5.1) to be set. One of the following events has occurred:

- An IEEE 488.2 syntax error has been detected by the parser. That is, a controller-to-device message was received which is in violation of the IEEE 488.2 standard. Possible violations include a data element which violates the device listening formats or whose type is unacceptable to the device.
- An unrecognized header was received. Unrecognized headers include incorrect device-specific headers and incorrect or unimplemented IEEE 488.2 common commands.

Events that generate command errors shall not generate execution errors, device-specific errors, or query errors; see the other error definitions in this chapter.

Error Code	Description
-100 Command Error	This is the generic syntax error for devices that cannot detect more specific errors. This code indicates only that a Command Error as defined in IEEE 488.2,11.5.1.1.4 has occurred.
-102 Syntax error	An unrecognized command or data type was encountered; for example, a string was received when the device does not accept strings.
-103 Invalid separator	The parser was expecting a separator and encountered an illegal character; for example, the semicolon was omitted after a program message unit, MEAS:VOLT:DC?:MEASCURR:DC?
-104 Data type error	The parser recognized a data element different than one allowed; for example, numeric or string data was expected but block data was encountered.
-108 Parameter not allowed	More parameters were received than expected for the header; for example, the :SYSTem:KLOCK command only accepts one parameter, so receiving SYSTem:KLOCK 1,0 is not allowed.
-109 Missing parameter	Fewer parameters were received than required for the header; for example, the :SYSTem:KLOCK command requires one parameter, so receiving :SYSTem:KLOCK is not allowed.
-111 Header separator error	A character which is not a legal header separator was encountered while parsing the header; for example, no white space followed the header, thus *SRE2 is an error.

-112 Program mnemonic too long	The header contains more than twelve characters (see IEEE 488.2, 7.6.1.4.1).
-113 Undefined header	The header is syntactically correct, but it is undefined for this specific device; for example, *XYZ is not defined for any device.
-114 Header suffix out of range	The value of a numeric suffix attached to a program mnemonic, see Syntax and Style section 6.2.5.2, makes the header invalid.
-115 Unexpected number of parameters	The number of parameters received does not correspond to the number of parameters expected. This is typically due to an inconsistency with the number of instruments in the selected group.
-120 Numeric data error	This error, as well as errors -121 through -129, are generated when parsing a data element which appears to be numeric, including the nondecimal numeric types. This particular error message should be used if the device cannot detect a more specific error.
-121 Invalid character in number	An invalid character for the data type being parsed was encountered; for example, an alpha in a decimal numeric or a "9" in octal data.
-128 Numeric data not allowed	A legal numeric data element was received, but the device does not accept one in this position for the header.
-131 Invalid suffix	The suffix does not follow the syntax described in IEEE 488.2, 7.7.3.2, or the suffix is inappropriate for this device.

-141 Invalid character data	Either the character data element contains an invalid character or the particular element received is not valid for the header.
-148 Character data not allowed	A legal character data element was encountered where prohibited by the device.
-151 Invalid string data	A string data element was expected, but was invalid for some reason (see IEEE 488.2, 7.7.5.2); for example, an END message was received before the terminal quote character.
-158 String data not allowed	A string data element was encountered but was not allowed by the device at this point in parsing.
-160 Block data error	This error, as well as errors -161 through -169, are generated when parsing a block data element. This particular error message should be used if the device cannot detect a more specific error.
-161 Invalid block data	A block data element was expected, but was invalid for some reason (see IEEE 488.2, 7.7.6.2); for example, an END message was received before the length was satisfied.
-168 Block data not allowed	A legal block data element was encountered but was not allowed by the device at this point in parsing.
-178 Expression data not allowed	A legal expression data was encountered but was not allowed by the device at this point in parsing.

Execution Errors

Overview An <error/event number> in the range [-299 , -200] indicates that an error has been detected by the instrument's execution control block. The occurrence of any error in this class shall cause the execution error bit (bit 4) in the event status register (IEEE 488.2, section 11.5.1) to be set. One of the following events has occurred:

- A <PROGRAM DATA> element following a header was evaluated by the device as outside of its legal input range or is otherwise inconsistent with the device's capabilities.
- A valid program message could not be properly executed due to some device condition.

Execution errors shall be reported by the device after rounding and expression evaluation operations have taken place. Rounding a numeric data element, for example, shall not be reported as an execution error. Events that generate execution errors shall not generate Command Errors, device-specific errors, or Query Errors; see the other error definitions in this section.

Error Code	Description
-200 Execution error	This is the generic syntax error for devices that cannot detect more specific errors. This code indicates only that an Execution Error as defined in IEEE 488.2, 11.5.1.1.5 has occurred.

-201 Invalid while in local	Indicates that a command is not executable while the device is in local due to a hard local control (see IEEE 488.2, 5.6.1.5); for example, a device with a rotary switch receives a message which would change the switches state, but the device is in local so the message cannot be executed.
-203 Command protected	Indicates that a legal password-protected program command or query could not be executed because the command was disabled.
-211 Trigger ignored	Indicates that a GET, *TRG, or triggering signal was received and recognized by the device but was ignored because of device timing considerations; for example, the device was not ready to respond. Note: a DT0 device always ignores GET and treats *TRG as a Command Error.
-213 Init ignored	Indicates that a request for a measurement initiation was ignored as another measurement was already in progress.
-220 Parameter error	Indicates that a program data element related error occurred. This error message should be used when the device cannot detect the more specific errors described for errors -221 through -229.
-221 Settings conflict	Indicates that a legal program data element was parsed but could not be executed due to the current device state (see IEEE 488.2, 6.4.5.3 and 11.5.1.1.5.).

-222 Data out of range	Indicates that a legal program data element was parsed but could not be executed because the interpreted value was outside the legal range as defined by the device (see IEEE 488.2, 11.5.1.1.5.).
-224 Illegal parameter value	Used where exact value, from a list of possibles, was expected.

Device Specific Errors

Overview An <error/event number> in the range [-399 , -300] or [1 , 32767] indicates that the instrument has detected an error which is not a command error, a query error, or an execution error; some device operations did not properly complete, possibly due to an abnormal hardware or firmware condition. These codes are also used for self-test response errors. The occurrence of any error in this class should cause the device-specific error bit (bit 3) in the event status register (IEEE 488.2, section 11.5.1) to be set. The meaning of positive error codes is device-dependent and may be enumerated or bit mapped; the <error message>string for positive error codes is not defined by SCPI and available to the device designer.

Note that the string is not optional; if the designer does not wish to implement a string for a particular error, the null string should be sent (for example, 42,""). The occurrence of any error in this class should cause the device-specific error bit (bit 3) in the event status register (IEEE 488.2, section 11.5.1) to be set. Events that generate device-specific errors shall not generate command errors, execution errors,

or query errors; see the other error definitions in this section.

Error Code	Description
-310 System error	Indicates that some error, termed “system error” by the device, has occurred. This code is device-dependent.
-320 Storage fault	Indicates that the firmware detected a fault when using data storage. This error is not an indication of physical damage or failure of any mass storage element.

Query Errors

Overview An <error/event number> in the range [-499 , -400] indicates that the output queue control of the instrument has detected a problem with the message exchange protocol described in IEEE 488.2, chapter 6. The occurrence of any error in this class shall cause the query error bit (bit 2) in the event status register (IEEE 488.2, section 11.5.1) to be set. These errors correspond to message exchange protocol errors described in IEEE 488.2, section 6.5. One of the following is true:

- An attempt is being made to read data from the output queue when no output is either present or pending;
- Data in the output queue has been lost.

Events that generate query errors shall not generate command errors, execution errors, or device-specific errors; see the other error definitions in this section.

Error Code	Description
-400 Query error	This is the generic query error for devices that cannot detect more specific errors. This code indicates only that a Query Error as defined in IEEE 488.2, 11.5.1.1.7 and 6.3 has occurred.

APPENDIX

Factory Default Settings

The following default settings are the factory configuration settings for the ASR-6000 series. For details on how to return to the factory default settings, see the User's Manual.

Continuous Mode	ASR-6450		ASR-6600	
	3P4W	1P2W	3P4W	1P2W
MODE	AC+DC-INT		AC+DC-INT	
Range	100V		100V	
ACV	0.00 Vrms		0.00 Vrms	
DCV	+0.00 Vdc		+0.00 Vdc	
FREQ	50.00Hz		50.00 Hz	
IRMS	15.75 A	47.25 A	21 A	63 A
ON Phs	Fixed 0.0°		Fixed 0.0°	
OFF Phs	Fixed 0.0°		Fixed 0.0°	
GAIN	100		100	
SIG	L1 LINE		L1 LINE	
Syc Phs	0.0		0.0	
SRC	L1 EXT		L1 EXT	
Wave	SIN		SIN	
Freq Limit	2000		2000	
Vrms Limit	175.0 Vrms		175.0 Vrms	
VPK+ Limit	+250 V		+250 V	
VPK- Limit	-250 V		-250 V	
IPK+ Limit	+63.00 A	+189.00 A	+84.00 A	+252.00 A
IPK- Limit	-63.00 A	-189.00 A	-84.00 A	-252.00 A

MISC Configuration	ASR-6450	ASR-6600
T peak , hold(msec)	1	1
Phase Mode	UNBalance	UNBalance
Peak CLR	ALL	ALL
Power ON	OFF	OFF
Buzzer	ON	ON
Remote Sense	OFF	OFF
V Response	Medium	Medium
Output Relay	Enable	Enable
THD Format	IEC	IEC
External Control	OFF	OFF
V Unit(TRI,ARB)	rms	rms
Set Change Phase	OFF	OFF
Monitor Output1	L1 Voltage	L1 Voltage
Monitor Output2	L1 Current	L1 Current
Monitor Output Amp	±2.5	±2.5
TrgOut Width(ms)	0.1	0.1
TrgOut Source	L1	L1
Re-Lock	OFF	OFF
Data Average Count	8	8
Data Update Rate		

LAN	ASR-6450	ASR-6600
DHCP	ON	ON

USB Device	ASR-6450	ASR-6600
Speed	Full	Full
Mode	TMC	TMC

RS232C	ASR-6450	ASR-6600
Baudrate	9600	9600
Databits	8bits	8bits
Parity	None	None
Stopbits	1bit	1bit

GPIB	ASR-6450	ASR-6600
Address	10	10

CAN BUS	ASR-6450	ASR-6600
Baudrate	125K	125K
Node ID	127	127

DeviceNet	ASR-6450	ASR-6600
Baudrate	125K	125K
Node ID	63	63

Output Impedance	ASR-6450	ASR-6600
Output Impedance	OFF	OFF
L1 Output Inductance	0.1 μ H	0.1 μ H
L2 Output Inductance	0.1 μ H	0.1 μ H
L3 Output Inductance	0.1 μ H	0.1 μ H
L1 Output Resistance	0.1 Ω	0.1 Ω
L2 Output Inductance	0.1 Ω	0.1 Ω
L3 Output Inductance	0.1 Ω	0.1 Ω

Sequence Mode	ASR-6450			ASR-6600		
Step	0			0		
Time	0.1000 s			0.1000 s		
Jump To	OFF			OFF		
Jump Cnt	1			1		
Branch 1	OFF			OFF		
Branch 2	OFF			OFF		
Term	CONTI			CONTI		
Sync Code	LL			LL		
Item	L1	L2	L3	L1	L2	L3
ACV	0.00, CT	0.00, CT	0.00, CT	0.00, CT	0.00, CT	0.00, CT
DCV	0.00, CT	0.00, CT	0.00, CT	0.00, CT	0.00, CT	0.00, CT
Fset	50.0 , CT	50.0 , CT	50.0 , CT	50.0 , CT	50.0 , CT	50.0 , CT
Wave	SIN	SIN	SIN	SIN	SIN	SIN
ON Phs	Free	Free	Free	Free	Free	Free
OFF Phs	Free	Free	Free	Free	Free	Free
Phase	Fixed (0)	120	240	Fixed (0)	120	240

Simulate Mode	ASR-6450			ASR-6600		
Step	Initial			Initial		
Repeat	OFF			OFF		
Time	0.1000 s			0.1000 s		
Term	Free			Free		
Code	LL			LL		
Item	L1	L2	L3	L1	L2	L3
ACV	0.00	0.00	0.00	0.00	0.00	0.00
Fset	50.00	50.00	50.00	50.00	50.00	50.00
Wave	SIN	SIN	SIN	SIN	SIN	SIN
ON Phs	Free	Free	Free	Free	Free	Free
OFF Phs	Free	Free	Free	Free	Free	Free

Default Waveform Setting

ARB 1 Ramp (rising)

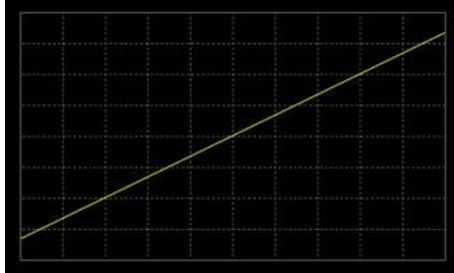

ARB 2 Ramp (falling)

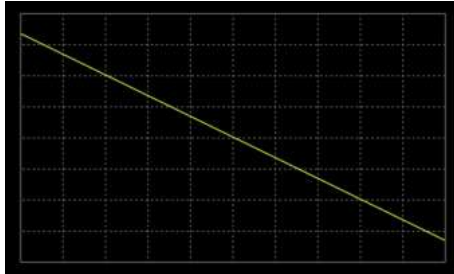

ARB 3 Sine wave, half-cycle(positive pole)

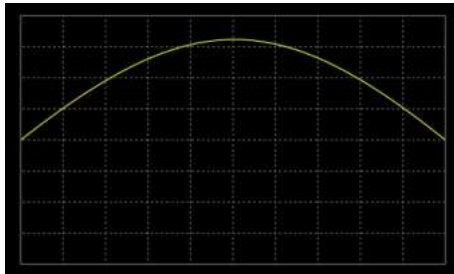

ARB 4 Sine wave, half-cycle(negative pole)

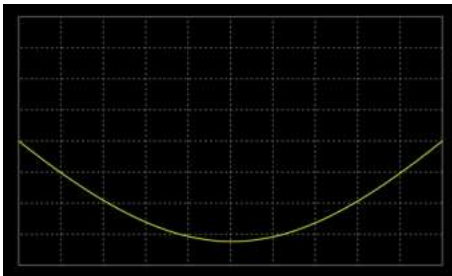
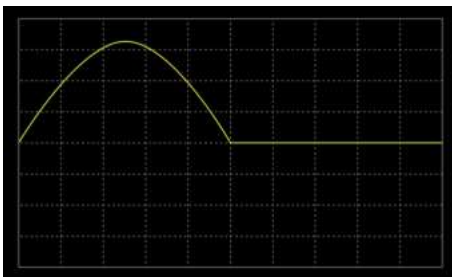
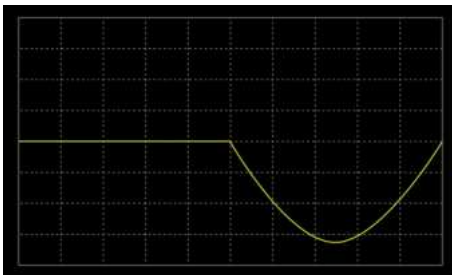
ARB 5 Sine wave, half-wave rectification
(positive polarity)ARB 6 Sine wave, half-wave
rectification(negative polarity)

ARB 7 Sine wave, full-wave
rectification(positive polarity)

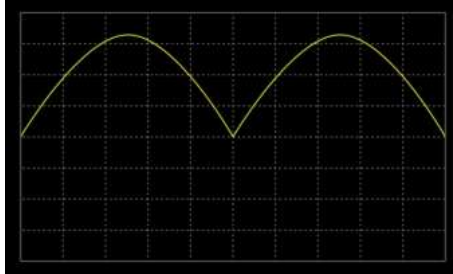

ARB 8 Sine wave, full-wave
rectification(negative polarity)



ARB 9 Second order step response(damping
coefficient 0.1)

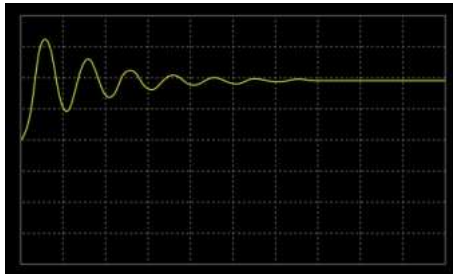

ARB 10 Second order step response(damping coefficient 0.2)

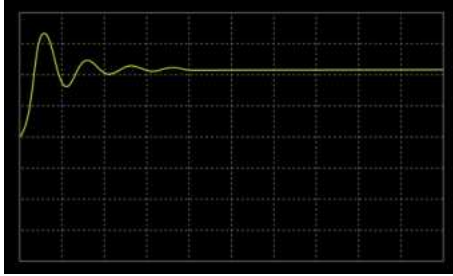

ARB 11 Second order step response(damping coefficient 0.7)

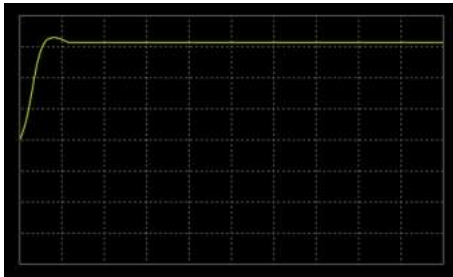

ARB 12 Second order impulse response(damping coefficient 0.1)

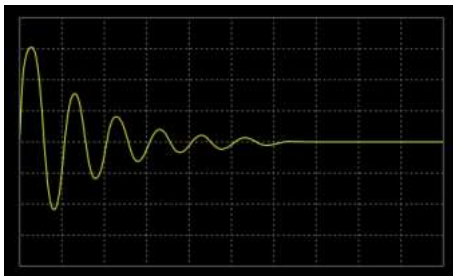

ARB 13 Second order impulse response(damping coefficient 0.2)

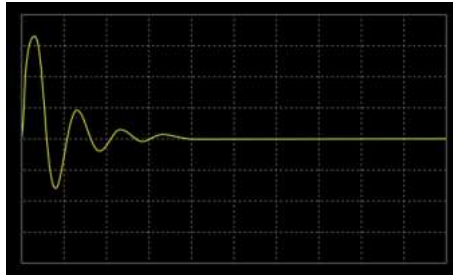

ARB 14 Second order impulse response(damping coefficient 0.7)

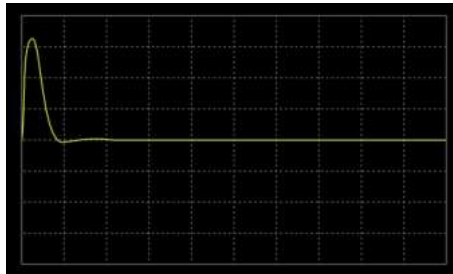

ARB 15 Exponential (rising)

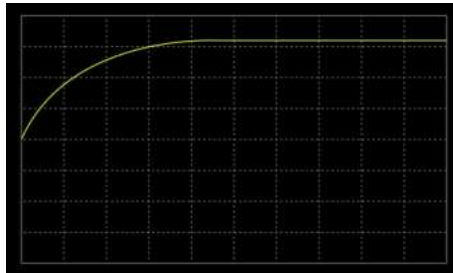

ARB 16 Exponential (falling)

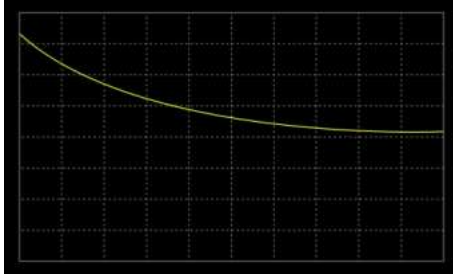

Default Sequence Setting

SEQ6 Momentary drop in supply voltage

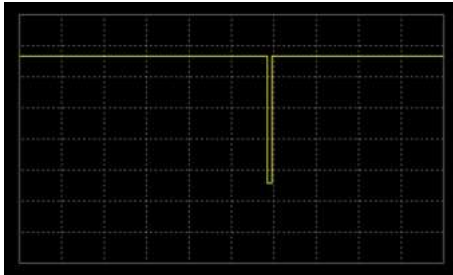

SEQ7 Reset test for Level1 systems with 12V

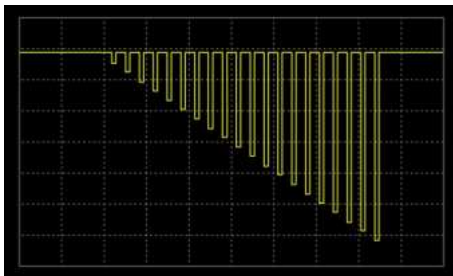

SEQ8 Starting Profile

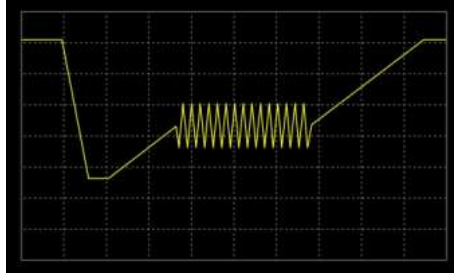

SEQ9 Test2 Tr: 10ms, Td: 40ms

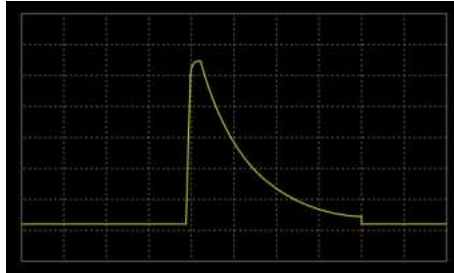

INDEX

Accessories	11	Command list	48
Caution symbol	4	Command syntax	44
Cleaning the instrument	7	Error list	185
Default settings	194	Ethernet	23
Disposal instructions	7	GPIB	33
EN61010		LAN	23
pollution degree	7	RS232	26
Environment		Status registers	169
safety instruction	7	USB	24
Ethernet		Remote control function check	
interface	23	GPIB	34
Front panel diagram	13	Realterm	30
Ground		RS-232	25, 29
symbol	4	USB	25, 29
List of features	10	Service operation	
Model differences	9	about disassembly	5
Power on/off		Socket server function check	39
safety instruction	6	Warning symbol	4
Remote control	21	Web server function check	38