

# Ground Bond Tester

GCT-9040

---

## USER MANUAL

GW INSTEK PART NO. 82CT-90400EA1



ISO-9001 CERTIFIED MANUFACTURER

**GW INSTEK**

This manual contains proprietary information, which is protected by copyright. All rights are reserved. No part of this manual may be photocopied, reproduced or translated to another language without prior written consent of Good Will company.

The information in this manual was correct at the time of printing. However, Good Will continues to improve products and reserves the rights to change specification, equipment, and maintenance procedures at any time without notice.

**Good Will Instrument Co., Ltd.**  
**No. 7-1, Jhongsing Rd., Tucheng Dist., New Taipei City 236, Taiwan.**

# Table of Contents

<b>SAFETY INSTRUCTIONS</b> .....	<b>5</b>
<b>GETTING STARTED</b> .....	<b>9</b>
GCT-9040 Overview .....	10
Appearance.....	14
Set Up.....	19
<b>OPERATION</b> .....	<b>25</b>
Menu Tree.....	26
Test Lead Connection.....	30
GB Manual Testing .....	36
Linked ACW/DCW/IR Tests .....	57
Common Utility Settings.....	66
<b>EXTERNAL CONTROL</b> .....	<b>74</b>
External Control Overview.....	75
<b>REMOTE CONTROL</b> .....	<b>81</b>
Interface Configuration .....	82
Command Syntax .....	86
Command List for GCT-9040.....	89
Error Messages.....	128
<b>FAQ</b> .....	<b>129</b>
<b>APPENDIX</b> .....	<b>131</b>
Fuse Replacement.....	131
Error Messages.....	132
GCT-9040 Specifications .....	134
GCT-9040 Dimensions .....	135
Declaration of Conformity.....	137

**I**NDEX..... 137

# S SAFETY INSTRUCTIONS

This chapter contains important safety instructions that you must follow during operation and storage. Read the following before any operation to ensure your safety and to keep the instrument in the best possible condition.

## Safety Symbols

These safety symbols may appear in this manual or on the instrument.

---



WARNING

Warning: Identifies conditions or practices that could result in injury or loss of life.



CAUTION

Caution: Identifies conditions or practices that could result in damage to the instrument or to other properties.



Attention Refer to the Manual



Protective Conductor Terminal



Frame or Chassis Terminal



Earth (ground) Terminal



Do not dispose electronic equipment as unsorted municipal waste. Please use a separate collection facility or contact the supplier from which this instrument was purchased.

## Safety Guidelines

---

### General Guideline



#### CAUTION

- Do not place any heavy object on the instrument.
- Avoid severe impact or rough handling that leads to damaging the instrument.
- Do not discharge static electricity to the instrument.
- Use only mating connectors, not bare wires, for the terminals.
- Do not block the cooling fan opening.
- Do not disassemble the GCT-9040 unless you are qualified.

(Measurement categories) EN 61010-1:2010 specifies the measurement categories and their requirements as follows. The GCT-9040 does not fall under category II, III or IV.

- Measurement category IV is for measurement performed at the source of low-voltage installation.
- Measurement category III is for measurement performed in the building installation.
- Measurement category II is for measurement performed on the circuits directly connected to the low voltage installation.

---

### Power Supply



#### WARNING

- AC Input voltage range:  
100/120/220/230VAC  $\pm 10\%$
  - Frequency: 50Hz/60Hz
  - To avoid electrical shock connect the protective grounding conductor of the AC power cord to an earth ground.
-

---

 Cleaning the  
GCT-9040

- Disconnect the power cord before cleaning.
  - Use a soft cloth dampened in a solution of mild detergent and water. Do not spray any liquid.
  - Do not use chemicals containing harsh material such as benzene, toluene, xylene, and acetone.
- 

 Operation  
Environment

- Location: Indoor, no direct sunlight, dust free, almost non-conductive pollution (Note below)
- Relative Humidity:  $\leq 70\%$  (no condensation)
- Altitude:  $< 2000\text{m}$
- Temperature:  $0^{\circ}\text{C}\sim 40^{\circ}\text{C}$

(Pollution Degree) EN 61010-1:2010 specifies the pollution degrees and their requirements as follows. The GCT-9040 falls under degree 2.

Pollution refers to “addition of foreign matter, solid, liquid, or gaseous (ionized gases), that may produce a reduction of dielectric strength or surface resistivity”.

- Pollution degree 1: No pollution or only dry, non-conductive pollution occurs. The pollution has no influence.
  - Pollution degree 2: Normally only non-conductive pollution occurs. Occasionally, however, a temporary conductivity caused by condensation must be expected.
  - Pollution degree 3: Conductive pollution occurs, or dry, non-conductive pollution occurs which becomes conductive due to condensation which is expected. In such conditions, equipment is normally protected against exposure to direct sunlight, precipitation, and full wind pressure, but neither temperature nor humidity is controlled.
- 

 Storage  
environment

- Location: Indoor
  - Temperature:  $-10^{\circ}\text{C}$  to  $70^{\circ}\text{C}$
  - Relative Humidity:  $\leq 85\%$  (no condensation)
- 

## Disposal



Do not dispose this instrument as unsorted municipal waste. Please use a separate collection facility or contact the supplier from which this instrument was purchased. Please make sure discarded electrical waste is properly recycled to reduce environmental impact.

## Power cord for the United Kingdom

When using the tester in the United Kingdom, make sure the power cord meets the following safety instructions.

NOTE: This lead/appliance must only be wired by competent persons



**WARNING: THIS APPLIANCE MUST BE EARTHED**

IMPORTANT: The wires in this lead are coloured in accordance with the following code:

Green/ Yellow:	Earth
Blue:	Neutral
Brown:	Live (Phase)



As the colours of the wires in main leads may not correspond with the coloured marking identified in your plug/appliance, proceed as follows:

The wire which is coloured Green & Yellow must be connected to the Earth terminal marked with either the letter E, the earth symbol  $\oplus$  or coloured Green/Green & Yellow.

The wire which is coloured Blue must be connected to the terminal which is marked with the letter N or coloured Blue or Black.

The wire which is coloured Brown must be connected to the terminal marked with the letter L or P or coloured Brown or Red.

If in doubt, consult the instructions provided with the equipment or contact the supplier.

This cable/appliance should be protected by a suitably rated and approved HBC mains fuse: refer to the rating information on the equipment and/or user instructions for details. As a guide, a cable of 0.75mm<sup>2</sup> should be protected by a 3A or 5A fuse. Larger conductors would normally require 13A types, depending on the connection method used.

Any exposed wiring from a cable, plug or connection that is engaged in a live socket is extremely hazardous. If a cable or plug is deemed hazardous, turn off the mains power and remove the cable, any fuses and fuse assemblies. All hazardous wiring must be immediately destroyed and replaced in accordance to the above standard.

# G E T T I N G   S T A R T E D

This chapter describes the safety tester in a nutshell, including its main features and front / rear panel introduction. After going through the overview, please read the safety considerations in the Set Up chapter.

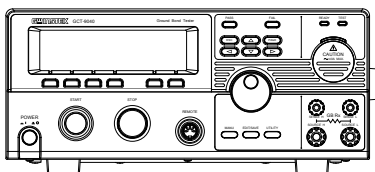

<b>GCT-9040 Overview</b> .....	<b>10</b>
Introduction to the GCT-9040 .....	10
Main Features .....	11
Accessories .....	11
Package Contents .....	13
 <b>Appearance</b> .....	 <b>14</b>
Front Panel .....	14
Rear Panel .....	17
 <b>Set Up</b> .....	 <b>19</b>
Line Voltage Connection and Power Up .....	19
Installing the Optional GPIB Card .....	21
Workplace Precautions .....	22
Operating Precautions .....	23

## GCT-9040 Overview

### Introduction to the GCT-9040

GCT-9040 is a ground bond tester that can operate as a standalone unit or in conjunction with a GPT-9000 Series safety tester to perform additional ACW/DCW/IR tests before, after or simultaneously (ACW/DCW only) with GB tests.

When the GCT-9040 operates with a GPT-9000 Series safety tester, it uses a dedicated LINK port and remote commands to communicate in a master-slave fashion. The GCT-9040 operates as the master and the GPT-9000 Series unit operates as a slave.

The GCT-9040 can store up to 100 manual tests allowing the safety testers to accommodate any number of safety standards, including IEC, EN, UL, CSA, GB, JIS and others.

Note: Throughout this user manual, the terms ACW, DCW, IR and GB refer to AC Withstanding, DC Withstanding, Insulation Resistance and Ground Bond testing, respectively. GPT-9000 refers to any of the GPT-98XX or GPT-99XX models, GPT-9000A refers to any of the GPT-99XXA models. For information specific to the GPT-9000, please see the GW Instek website, <http://www.gwinstek.com>.

## Main Features

---

Performance	<ul style="list-style-type: none"> <li>• GB: 3A~40A ac</li> </ul>
Features	<ul style="list-style-type: none"> <li>• 100 test conditions (MANU mode)</li> <li>• Over temperature, voltage and current protection</li> <li>• Pass, Fail, Test, Caution and Ready indicators</li> <li>• PWM output (90% efficiency, increased reliability)</li> <li>• Interlock (configurable).</li> </ul>
Interface	<ul style="list-style-type: none"> <li>• Remote control start/stop interface terminal</li> <li>• USB interface for programming</li> <li>• Optional GPIB interface for programming</li> <li>• Signal I/O port for pass/fail/test monitoring and start/stop control/interlock</li> <li>• LINK port to control slave units for ACW, DCW and IR tests.</li> </ul>

## Accessories

---

Standard Accessories	Part number	Description
	Region dependent	Power cord
	GTL-215 x1	GB Test leads
	N/A	Remote terminal male plug
	N/A	Interlock key
	GTL-247	Type A-A USB cable
	GTL-132	Link cable

Optional Accessories	Part number	Description
	GTL-248	GPIB cable
	GTL-251	GPIB-USB-HS (high speed)
	GRA-417	Rack Adapter Panel (19", 4U)
Options	Part number	Description
	Opt.01 GPIB Interface	GPIB card

## Package Contents

Check the contents before using the GCT-9040.

---

### Opening the box

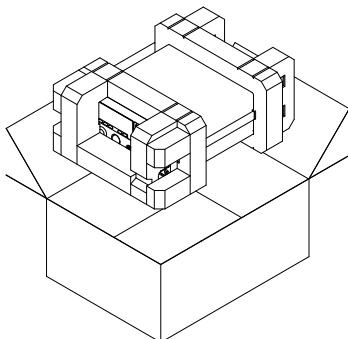

---

#### Contents (single unit)

- GCT-9040 unit
  - Quick Start guide
  - User manual CD
  - CTC (Calibration Traceable Certificate)
  - Type A-A USB cable
  - Power cord x1 (region dependent)
  - GTL-215 test leads x1
  - GTL-132 LINK cable
  - Remote terminal male plug
  - Interlock key
- 



#### Note

Keep the packaging, including the box, polystyrene foam and plastic envelopes should the need arise to return the unit to GW Instek.

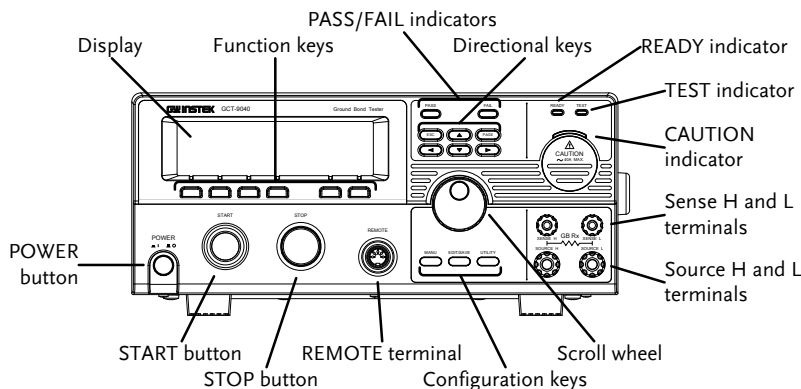

# Appearance

## Front Panel





Display                    240 X 64 dot matrix display (LCD)

Function keys            The function keys correspond to the soft-keys directly above on the main display.

Pass/Fail indicators         The PASS and FAIL indicators light up upon a PASS or FAIL test result at the end of a manual test or automatic test.

ESC key                                The ESC key is used to exit out of a menu or cancel a setting.

PAGE key                                The PAGE key is used in the EDIT status to toggle the HI/LO setting between mΩ & V.

Directional arrow keys                The directional arrow keys are used to navigate menus and parameter settings.

READY indicator  The READY indicator is lit when the tester is ready to begin testing. The STOP button is used to put the tester into READY status.

TEST indicator  The TEST indicator is lit when a test is on. The START button is used to put the tester into TEST status.

CAUTION indicator  The CAUTION indicator will light up when the output terminals are active. Only after the test has finished or stopped will the indicator turn off.

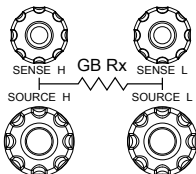
SENSE and SOURCE terminals  The SOURCE H, SOURCE L, SENSE H and SENSE L terminals are used for GB testing.

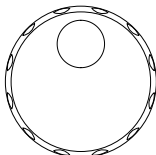
Scroll wheel  The scroll wheel is used to edit parameter values.

UTILITY key  Used to enter the Common Utility menu.

EDIT/SAVE key  Used to start editing MANU tests as well as save settings and parameters.

MANU key  The MANU key is used to select manual tests.

REMOTE terminal

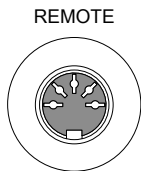

The REMOTE terminal is used to connect to a remote controller.

STOP button

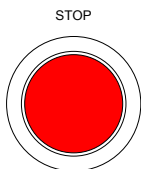

The STOP button is used to stop/cancel tests. The STOP button will also put the tester in the READY status to begin testing.

START button

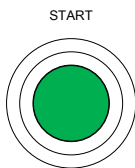

The START button is used to start tests.

The START button can be used to start tests when the tester is in the READY status. Pressing the START button will put the tester in the TEST status.

POWER switch

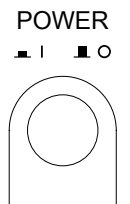

Turns the power on. The tester will always start up with the last test setting from when the instrument was last powered down.

Rear Panel

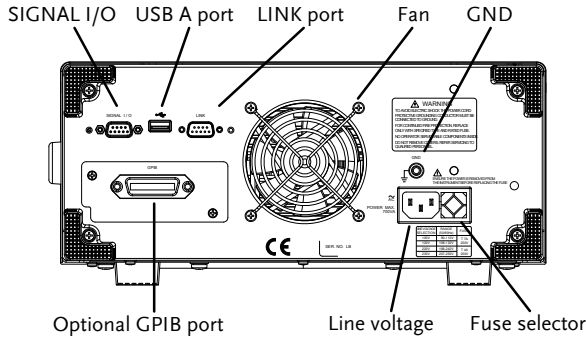

SIGNAL I/O port

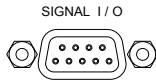

The SIGNAL I/O port is used to monitor the tester status (PASS, FAIL, TEST) and input (START/STOP signals). It is also used with the Interlock key.

USB A port



Used for remote control and firmware updates.

LINK port

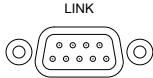

With the GCT-9040 acting as the master unit, the LINK port is used to control a GPT-9XXX slave unit to perform additional ACW, DCW or IR tests.

Fan/Fan Vents

Exhaust fan. Allow enough room for the fan to vent. Do not block the fan openings.

GND

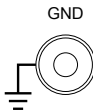

Connect the GND (ground) terminal to the earth ground.

Line voltage input

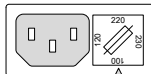

Line voltage input:  
100/120/220/230VAC  $\pm 10\%$

Line voltage fuse

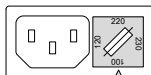

Line voltage selector and fuse:  
100V/120V      T7A 250V  
220V/230V      T4A 250V

Optional GPIB  
port

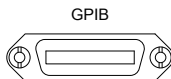

Optional GPIB interface for remote control.

# Set Up

## Line Voltage Connection and Power Up

**Background** Before powering up the GCT-9040 ensure the correct voltage has been selected on the rear panel. The GCT-9040 supports line voltages of 100V/120V/220V and 230V.

- Steps**
1. Check the line voltage and the fuse Page 131 in the fuse holder.

The desired line voltage should line up with the arrow on the fuse holder.

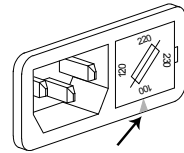

2. Connect the power cord to the AC voltage input.

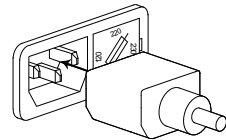

3. If the power cord does not have an earth ground, ensure the ground terminal is connected to an earth ground.

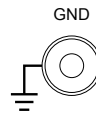

 **Warning**

Ensure the power cord is connected to an earth ground. Failure could be harmful to the operator and instrument.

4. Press the Power button.

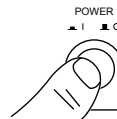

5. When the unit is powering up, all the LED indicators will light. Check to make sure all 5 LED indicators are working.
6. Check to make sure the System Self Test passes without errors.

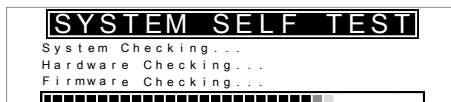

After the System Self Test completes, the tester will go into VIEW status and be ready to operate.

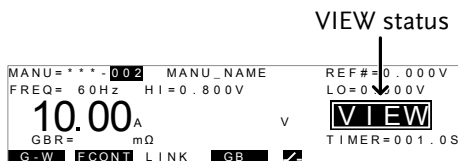

See the Appendix on page 132 for details if a self-test error is detected.

## Installing the Optional GPIB Card

**Background**                      The optional GPIB is a user-installable option. Follow the instructions below to install the GPIB card.

 **WARNING**                      Before installing the optional GPIB card ensure the GCT-9040 is turned off and disconnected from power.

**Steps**                                      1. Remove the screws from the rear panel cover plate.

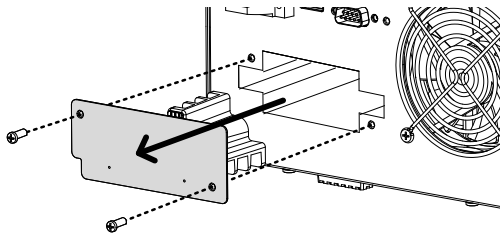

2. Insert the GPIB card into the two slots on either side of the opening. Push the card gently until it is fully inserted.

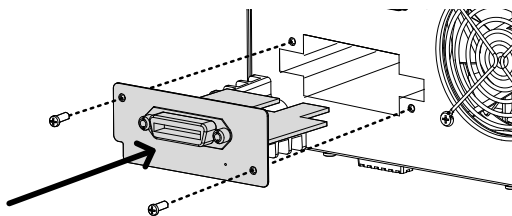

## Workplace Precautions

---

**Background**                    The GCT-9040 is a high current instrument that is capable of delivering up to 40A. The following section describes precautions and procedures that must be followed to ensure a safe work environment.

---



### WARNING

The GCT-9040 generates high current in excess of 40A. Follow all safety precautions, warnings and directions given in the following section when using the instrument.

---

1. Only technically qualified personnel should be allowed to operate the tester.
2. The operating workplace must be fully isolated, especially when the instrument is in operation. The instrument should be clearly labeled with appropriate warning signage.
3. The operator should not wear any conductive materials, jewelry, badges, or other items, such as wrist watches.
4. The operator should wear insulation gloves for electrical protection.
5. Ensure the earth ground of the line voltage is properly grounded.
6. When high current flows through the test leads a strong magnetic field is produced. Ensure any devices that are adversely affected by magnetic fields are not placed near the tester.

## Operating Precautions

---

**Background**      The GCT-9040 is a high current instrument. The following section describes precautions and procedures that must be followed to ensure that the tester is operated in a safe manner.

---



### WARNING

The GCT-9040 generates outputs up to 40A ac. Follow all safety precautions, warnings and directions given in the following section when using the instrument.

---

1. Never touch the tester, lead wires, terminals, probes and other connected equipment when the tester is testing.
2. After testing, any probes, terminals or ports may become extremely hot due to the high test current. Do not touch these points to avoid burns.
3. Do not turn the tester on and off quickly or repeatedly. When turning the power off, please allow a few moments before turning the power back on. This will allow the protection circuits to properly initialize.

Do not turn the power off when a test is running, unless in an emergency.

4. Only use those test leads supplied with the instrument. Leads with inappropriate gauges can be dangerous to both the operator and the instrument.  
Never use the Sense leads on the SOURCE terminals.

5. Ensure the earth ground of the line voltage is properly grounded.
6. Only connect the test leads to the SOURCE H/SENSE H terminals before the start of a test. Keep the test leads disconnected at all other times.
7. Always press the STOP button when pausing testing.
8. Do not leave the tester unattended. Always turn the power off when leaving the testing area.
9. When remotely controlling the tester, ensure adequate safety measures are in place to prevent:
  - Inadvertent output of the test current.
  - Accidental contact with the instrument during testing. Ensure that the instrument and DUT are fully isolated when the instrument is remotely controlled.

# OPERATION

---

<b>Menu Tree</b> .....	<b>26</b>
Menu Tree Overview .....	27
<b>Test Lead Connection</b> .....	<b>30</b>
GB Connection.....	30
Grounding Mode Note .....	33
<b>GB Manual Testing</b> .....	<b>36</b>
Choose/Recall a Manual Test Number .....	37
Edit Manual Test Settings .....	38
Setting the GB Test Current .....	39
Setting the Test Frequency .....	39
Setting the Upper and Lower Limits .....	40
Setting a Reference Value .....	42
Setting the Test Time (Timer) .....	43
Creating a MANU Test File Name.....	44
Saving and Exiting EDIT Status .....	45
Running a MANU Test.....	47
PASS / FAIL MANU Test.....	51
Zeroing of the Test Leads .....	54
<b>Linked ACW/DCW/IR Tests</b> .....	<b>57</b>
LINK Connection .....	58
LINK Test Configuration .....	60
Run LINK Test.....	63

# Menu Tree

This section describes the overall structure of the operation statuses and modes for the GCT-9040 ground bond safety tester. The tester has one testing mode (MANU mode) and 5 main operation statuses (VIEW, EDIT, READY, TEST and STOP).

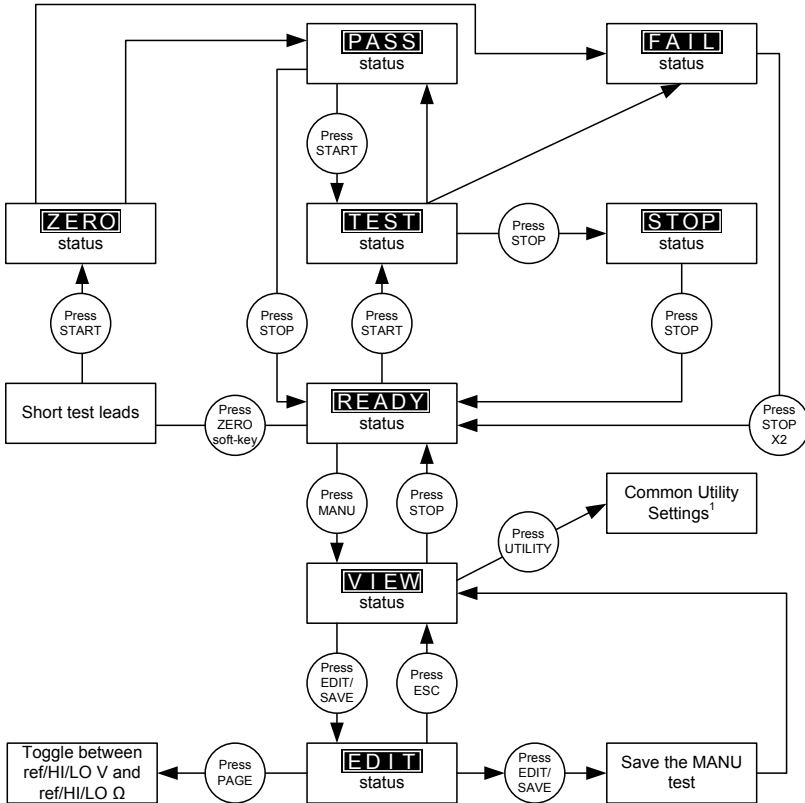

<sup>1</sup> Press EDIT/SAVE to save settings, or ESC to cancel and return to the previous screen.

## Menu Tree Overview

### VIEW status

VIEW status is used to view the parameters of the selected manual test. The VIEW status is also used to select the MANU test number. VIEW status is the default state of the unit.

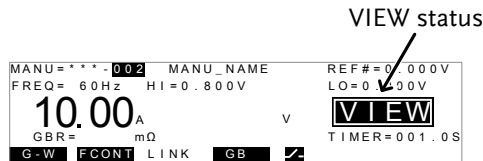

### EDIT status

EDIT status is used to edit the manual test parameters. Pressing the EDIT/SAVE key will save any changes. Pressing the ESC key will cancel any changes.



### READY status

When the tester is in READY status, it is ready to begin testing. Pressing the START button will begin testing and put the tester into TEST status. Pressing the MANU key will return the tester to VIEW status.

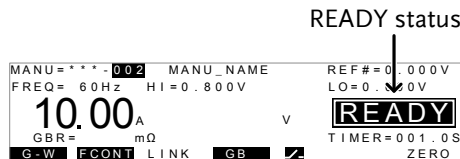

TEST status

TEST status is active when a MANU test is running. Pressing STOP will cancel the test.

TEST status

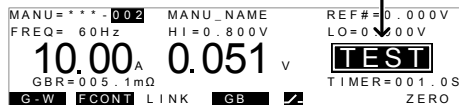

STOP status

STOP status is shown when a manual test did not finish running and has been stopped by the operator. Pressing STOP will return the tester to READY status.

STOP status

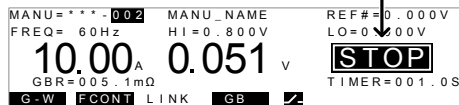

ZERO status

ZERO status is shown when performing a zeroing test for the test leads. Performing a zeroing test will automatically set the REF# value for the selected test.

ZERO status

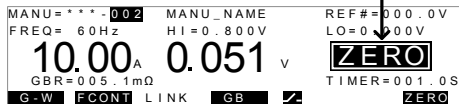

MANU test number

When in the VIEW mode, you can select a MANU test number with the scroll wheel.

MANU test number



**Common Utility  
Settings**

This utility controls the LCD, buzzer, interface, control and time settings. These settings are system wide.



## Test Lead Connection

This section describes how to connect the GCT-9040 to a DUT for ground bond testing. The DUT should be floating with respect to ground and should be powered off.

### GB Connection

#### Background

GB tests use the SENSE H/L and SOURCE H/L terminals with the GTL-215 test leads.

#### Single GB Connection

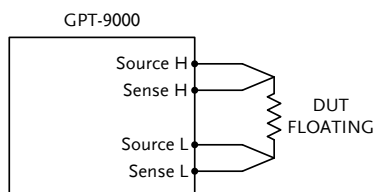

Ground bond tests are usually connected between the ground pin (conductor terminal) of the DUT's power cord or power socket and a conductive point on the DUT chassis.

#### ACW/DCW/IR and GB Connection

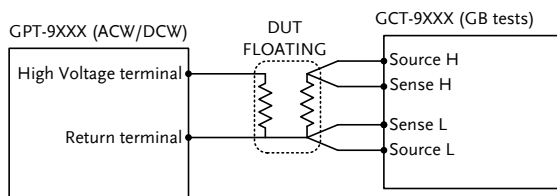

ACW, DCW and IR withstanding tests are usually performed by testing the withstanding potential (ACW/DCW) or resistance (IR) from the neutral or live pin and the ground pin (conductor terminal) of the DUT.

Steps for GB  
Connection  
(GCT-9040)

1. Turn the power off on the safety tester.
2. Using the GTL-215 GB test lead,
  - a. Connect the Sense H lead to the SENSE H terminal.
  - b. Connect the Sense L lead to the SENSE L terminal.
  - c. Connect the Source H lead to the SOURCE H terminal.
  - d. Connect the Source L lead to the SOURCE L terminal.

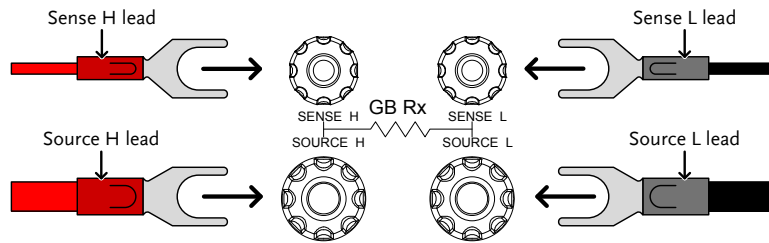

- e. Connect the H clip of the GB test lead to a conductive point on the DUT chassis.
- f. Connect L clip of the GB test lead to the ground (conductor terminal) pin of the DUT power cord or power socket.

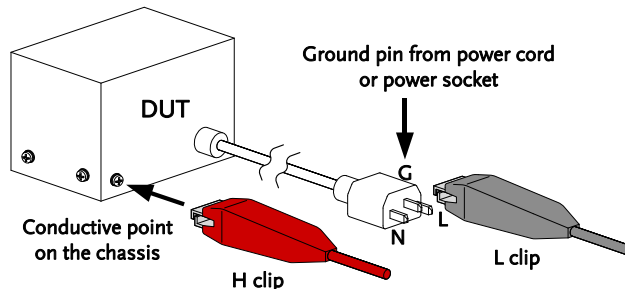

Steps for  
ACW/DCW/IR  
Connection  
(GPT-9XXX)

1. Turn the power off on the GPT-9XXX safety tester.
2. Using the GHT-114 test leads,
  - a. Connect the high voltage test lead(red) to the HIGH VOLTAGE terminal and screw firmly into place.
  - b. Connect the return test lead(white) into the RETURN terminal and screw the protector bar into place, as shown below.

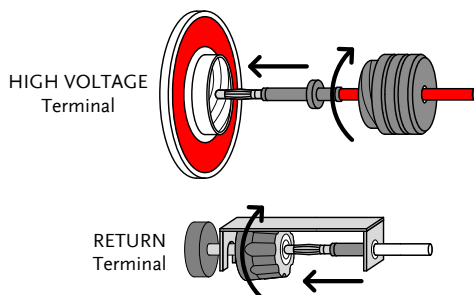

- c. Connect the high potential clip to neutral or live pin of the power cord or socket of the DUT that you want to test.
- d. Connect the return clip to the ground pin (conductor terminal) of the power cord or socket.

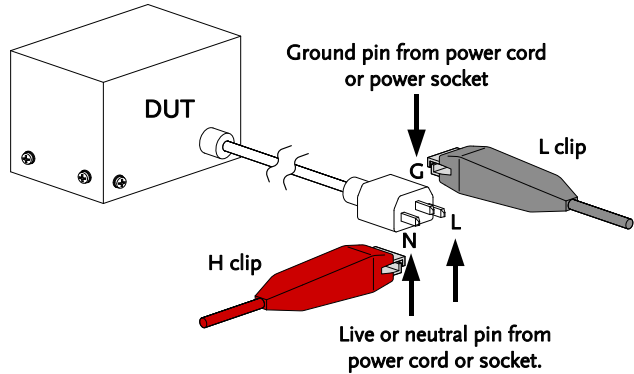

## Grounding Mode Note

---

### Background

The GCT-9040 operates with the SOURCE L terminal floating with respect to the earth ground. For the GCT-9040 and GPT-9XXX Series, this is referred to as having the GROUND MODE is set to OFF. On the GCT-9040 this mode is fixed.

When performing additional ACW or DCW tests, a slave GPT-9XXX Series unit can operate with the GROUND MODE set to ON or OFF.

Overview

GROUND MODE = OFF

This mode is for DUTs that are floating and not directly connected to an earth ground. When GROUND MODE is set to OFF any stray capacitance/resistance that leaks to the earth ground from the DUT side of the testing circuit are not measured. GB and IR tests must operate with GROUND MODE = OFF.

GROUND MODE = ON

When GROUND MODE is set to ON, the GPT-9XXX grounds the return terminal to the ground. This mode measures the potential of the HIGH VOLTAGE terminal with respect to earth ground. This means that any stray capacitance/resistance that leaks to earth ground will also be measured.

For further details about the grounding mode for the ACW, DCW and IR tests, please see the GPT-9XXX user manual.

Ground Mode Icons

The ground mode icons represent the ground mode settings.

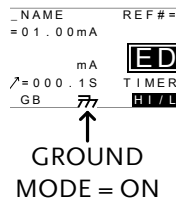
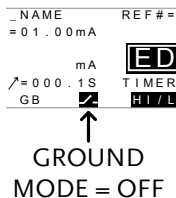



Warning

The GCT-9040 is a floating device. The DUT ground mode setup depends on the GPT-9XXX ground mode setting.

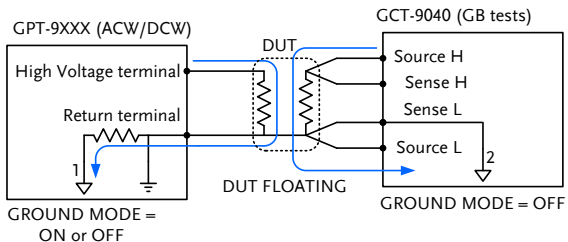
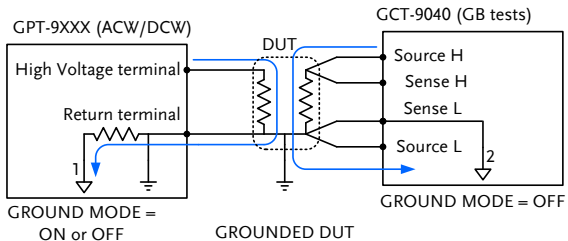

## GB Manual Testing

This section describes how to create, edit and run a *single* GB safety test. Each Manual setting described in this chapter *only applies to the selected* manual test – *no other manual tests are affected*.

Each manual test can be created/stored/recalled to/from one of 100 memory locations.

- Choose/Recall a Manual Test number → from page 37.
- Edit Manual Test Settings → from page 38.
- Setting the GB Test Current → from page 39.
- Setting the Test Frequency → from page 39.
- Setting the Upper and Lower Limits → from page 40.
- Setting a Reference Value → from page 42.
- Setting the Test Time (Timer) → from page 43.
- Creating a MANU Test File Name → from page 44.
- Saving and Exiting EDIT Status → from page 45.
- Running a MANU Test → from page 47.
- PASS / FAIL MANU Test → from page 51.
- Zeroing of the Test Leads → from page 54

Before operating the GCT-9040 please read the safety precautions as outlined in the Set Up chapter on page 19.

## Choose/Recall a Manual Test Number

**Background** Up to 100 different manual tests can be saved/recalled. MANU tests are selected in the VIEW status.

- Steps**
1. Ensure that the tester is in VIEW status.  
  
See the menu tree on page 26 for details on how to enter the VIEW status.

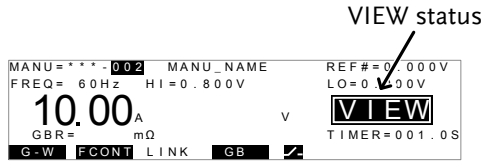

2. Use the scroll wheel to choose the MANU number.

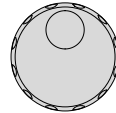

MANU # 001~100



 **Note**

The MANU number can only be chosen in VIEW status. If in the EDIT status, switch to the VIEW status by pressing the EDIT/SAVE or ESC key.

## Edit Manual Test Settings

**Background** To edit any of the manual test settings, the tester must be in EDIT status.

Any settings or parameters that are edited only apply to the currently selected MANU number.

**Steps**

1. Press the EDIT/SAVE key when in VIEW status to enter the EDIT status. This will enter the EDIT status for the currently chosen test number.

EDIT/SAVE



Currently selected  
MANU test number



2. The Status changes from VIEW to EDIT.



Note

Pressing the EDIT/SAVE key again will save the settings for the current test and return back to VIEW status.

## Setting the GB Test Current

**Background**                      The GB test current can be set from 3A to 40A ac.

- Steps**
1. Ensure the tester is in EDIT status.    Page 38
  2. Press the UP / DOWN arrow keys to bring the cursor to the current setting.

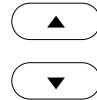

cursor

3. Use the scroll wheel to set the current level.

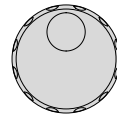

GB                      3.00A ~ 40.00A ac





The ground bond voltage (GBV) is calculated as the HI limit voltage + REF voltage (or (HI limit Ω + REFΩ) X test current).

## Setting the Test Frequency

**Background**                      A test frequency of 60Hz or 50Hz can be set, regardless of the input line voltage.

- Steps**
1. Ensure the tester is in EDIT status.    Page 38

- Press the UP / DOWN arrow keys to bring the cursor to the **FREQ** setting.
 

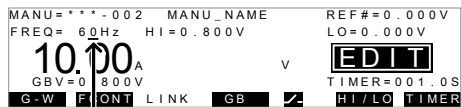

cursor

- Use the scroll wheel to set the test frequency.
 

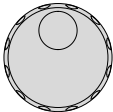

Frequency 50Hz, 60Hz

## Setting the Upper and Lower Limits

---

### Background

There is both a LO and HI judgment setting. When the measured value is below the LO SET setting, the test will be judged as FAIL. When the value exceeds the HI SET setting the test will be judged as FAIL. Any measurement between the LO SET and HI SET setting is judged as PASS. The LO SET limit cannot be made greater than the HI SET limit.

### Steps

- Ensure the tester is in EDIT status. Page 38
- Press the **PAGE** to choose the HI and LO value units (voltage or resistance).
 





Note

toggling the HI/LO units will also toggle the REF# units as well (REF# mΩ, REF# V). The REF# units and the HI/LO units are the same. If the units are changed, the REF# value will need to be set again. See page 42 for setting the REF# value.

3. Press the HI/LO soft-key or use the UP / DOWN arrow keys to bring the cursor to the HI limit setting.

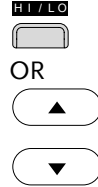

4. Use the scroll wheel to set the HI limit.

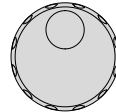

HI            000.1mΩ ~ 650.0mΩ  
                  0.001V ~ 7.200V

5. Repeat steps 2 and 3 for the LO limit setting.

LO            000.0mΩ ~ 649.9mΩ  
                  0.000V ~ 7.199V

Example: V units

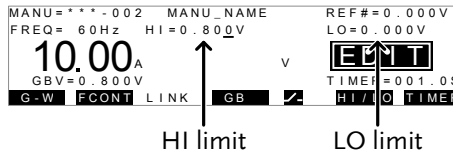

Example: Ω units

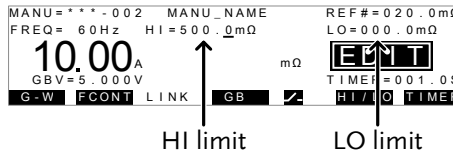



Note



The LO SET setting is limited by the HI SET setting. The LO SET limit cannot be greater than the HI SET limit.

## Setting a Reference Value

**Background**                      The REF# acts as an offset. The REF# value is subtracted from the measured current (ACW, DCW) or measured resistance (IR, GB).

- Steps**
1. Ensure the tester is in EDIT status.    Page 38
  2. Press the PAGE soft-key to choose the REF# value unit (voltage or resistance).    

 **Note**                      Toggling the REF# units will also toggle the HI/LO units (HI/LO mΩ, HI/LO V). The REF# units and the HI/LO units are the same. If the units are changed, the HI/LO settings will need to be set again. See page 40 for setting the HI/LO values.

3. Press the UP / DOWN arrow keys to bring the cursor to the REF# setting.     

4. Use the scroll wheel to set the REF# value.

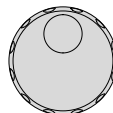

REF# (Ω)    000.0mΩ ~ 650.0mΩ  
 REF# (V)    0.000V ~ 7.200V

Example: V units

REF#  
↓

MANU=***-002	MANU_NAME	REF#=0.500V
FREQ= 60Hz	HI=0.800V	LO=0.000V
<b>10.00</b>	A	<b>EDIT</b>
GBV=1.300V	V	TIMER=001.0S
G-W	FCONT	LINK
GB	[Icon]	HI/LO
		TIMER

Example: Ω units

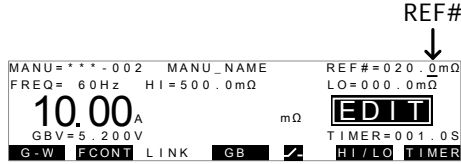

Note

Limitations:  
 $((\text{REF\# } (\Omega) + \text{HI Set } (\Omega)) \times I \text{ Set}) < 7.2\text{V}$   
 $((\text{REF\# } (\text{V}) + \text{HI Set } (\text{V})) < 7.2\text{V}$



Note

A reference offset can be automatically created using the zeroing function. See page 54 for details.

## Setting the Test Time (Timer)

Background

The TIMER setting is used to set the test time for the current test. The test time determines how long the test current is applied to the DUT. The test time can be set from 0.5 to 999.9 seconds, with a resolution of 0.1 seconds.

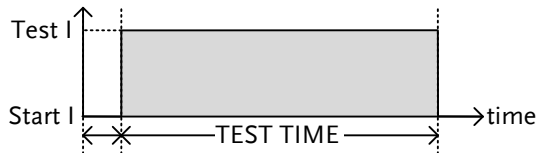

Initial time  
 (Approximately 100ms)



Note

Each test has an initial test time of approximately 100ms. This time cannot be edited.

Steps

1. Ensure the tester is in EDIT status. Page 38

- Press the **TIMER** soft-key or use the **UP/DOWN** arrow keys to bring the cursor to the **TIMER** setting.

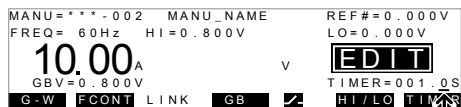
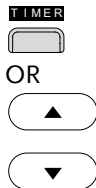

cursor

- Use the scroll wheel to set the **TIMER** value.

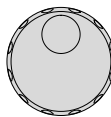

GB 000.5s~999.9s

## Creating a MANU Test File Name

### Background

Each MANU test can have a user-defined test file name (default: MANU\_NAME) up to 10 characters long. See the character list below for the allowed characters.



#### Character List:

0	1	2	3	4	5	6	7	8	9																
A	B	C	D	E	F	G	H	I	J	K	L	M	N	O	P	Q	R	S	T	U	V	W	X	Y	Z
a	b	c	d	e	f	g	h	i	j	k	l	m	n	o	p	q	r	s	t	u	v	w	x	y	z
+	-	*	/	_	=	:	Ω	?	(	)	<	>	[	]											

### Steps

- Ensure the tester is in **EDIT** status. Page 38



- Use the UP/DOWN arrow keys to bring the cursor to the MANU test file name at the top of the screen. The test file name is initially set as MANU\_NAME.
 

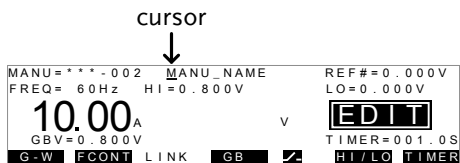

- Use the scroll wheel to scroll through the available characters.
 

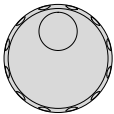
- Press the Left/Right arrow keys to go the next character.
 



- The MANU test file name is set when the current test setting is saved or when the cursor is moved to another setting.

## Saving and Exiting EDIT Status

---

Background	After all test parameters have been set, the test can be saved.
------------	---

---

Steps	<ol style="list-style-type: none"> <li>When in EDIT status, press the EDIT/SAVE key to save the current test. This will enter the VIEW status for the chosen test number.                     <div style="float: right; margin-top: -20px;">  </div> </li> </ol>
-------	---

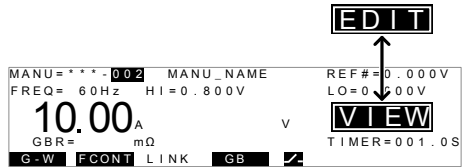

2. The Status changes from EDIT to VIEW.

---



Note

Pressing the EDIT/SAVE key again will return the tester back to EDIT status for the current test.

## Running a MANU Test

**Background** A test can be run when the tester is in READY status.



Note

The tester cannot start to run a test under the following conditions:

- A protection setting has been tripped; when a protection setting has been tripped the corresponding error message is displayed on the screen. See page 133 for a comprehensive list of the all the setting errors.
- The INTERLOCK function is ON and the Interlock key is not inserted in the signal I/O port (page 70).
- The STOP signal has been received remotely.

If Double Action is ON, ensure the START button is pressed immediately after the STOP button (<0.5s).



Note

When a test is running the current output cannot be changed.

- Steps**
1. Ensure the tester is in VIEW status Page 45 for the current test. Save the current test if necessary.



- 2. Press the STOP button to put the tester into the READY status.

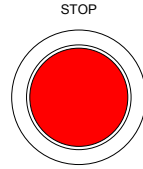

READY status

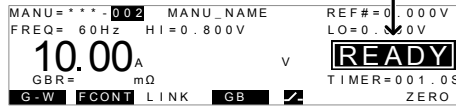

- 3. The READY indicator will be lit blue when in the READY status.



- 4. Press the START button when the tester is in the READY status. The manual test starts automatically and the tester goes into the TEST status.

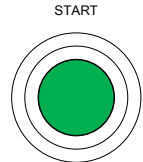

- 5. The TEST indicator will be lit orange when in the TEST status.



TEST status

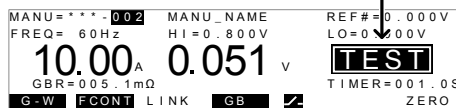

- 6. The test will start by showing the remaining test time. The test will continue until the test is finished or the test is stopped.

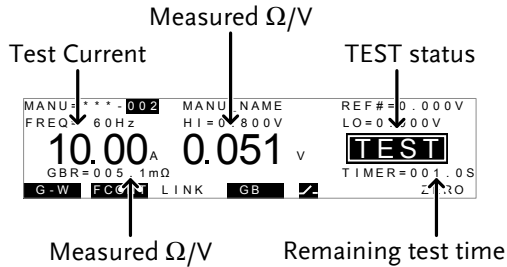

**Stop the Test**

1. To stop the test at any time when it is running, press the STOP button. The test will stop immediately. When the STOP button is pressed, a judgment is not made on the test.

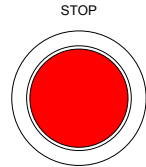

All panel keys except the STOP button are locked when the tester is in STOP status.

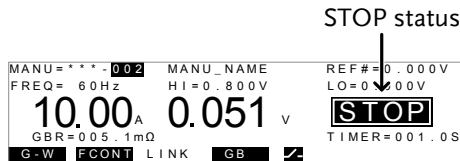

2. To put the tester back into READY status, press the STOP button again.

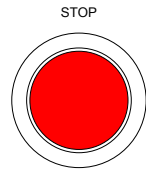

**Exit TEST Status**

To exit testing, press the MANU key when the tester is in the READY status. The tester will revert to the VIEW status for the current test.



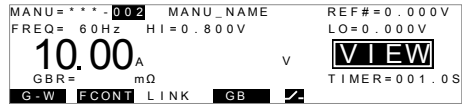

Note

Do not touch any terminals, test leads or any other connections when the test is on.

---

## PASS / FAIL MANU Test

**Background**                      If the test is allowed to run to completion (the test is not stopped or a protection setting is not tripped) then the tester will judge the test as either PASS or FAIL.



**Note**

The test will be judged PASS when:

- The HI and LO limits have not been tripped during the test time.

The test will be judged FAIL when:

- Either the HI or LO limit has been tripped during the test time.
- A protection setting has been tripped during the test time. See page 133 for a list of error messages.

**PASS Judgment**    1. When the test is judged as PASS, PASS will be displayed, the buzzer will sound and the PASS indicator will be lit green.

PASS



2. The PASS judgment will be held on the display until the STOP or START button is pressed.

Pressing the STOP button will return the tester to the READY status.

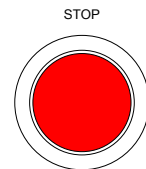

Pressing the START button will restart the test.

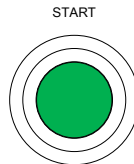

Note

The buzzer will only sound if the Pass Sound is set to ON. See page 67 for buzzer details.

The START button is disabled when the buzzer is beeping.

**PASS Timing Diagrams**

The timing diagrams below show the GB timing for the START status, TEST status and PASS judgment. All the test lines are active low.

**GB PASS Timing**

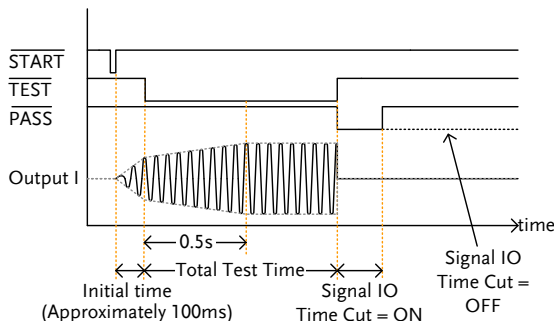

**FAIL Judgment**

1. When the test is judged as FAIL, FAIL will be displayed, the buzzer will sound and the FAIL indicator will be lit red.



As soon as a test is judged FAIL, power is cut from the terminals.

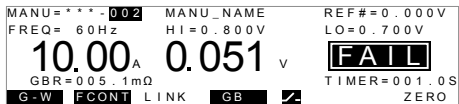

- The FAIL judgment will be held on the display until the STOP button is pressed. Pressing the STOP button twice will return the tester to the READY status.

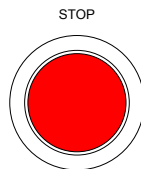

X2

- The READY indicator will be lit blue in the READY status.



READY status

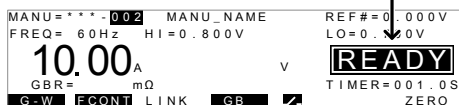

Note

The buzzer will only sound if Fail Sound is set to ON. See page 67 for details.

**FAIL Timing Diagrams**

The timing diagrams below show the GB timing for the START status, TEST status and FAIL judgment. All test lines are active low.

**GB FAIL Timing**

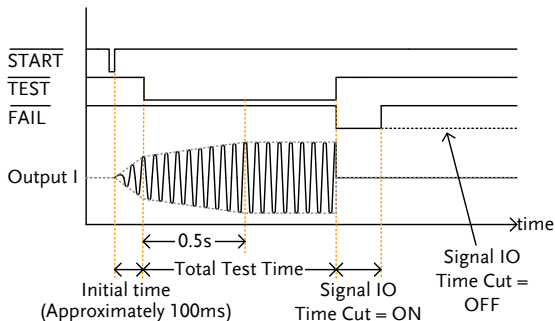

## Zeroing of the Test Leads

**Background**                      The Zeroing function is used to determine the resistance of the test leads for GB tests. When a zero check is performed, the reference is automatically set to the measured resistance of the test leads.

- Steps**
1. Ensure the tester is in **VIEW** status Page 45 for the current GB test. Save the current test if necessary.



2. Short the positive and negative alligator clips as shown below.

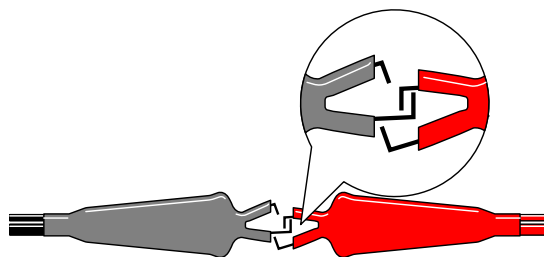

3. Press the **STOP** button to put the tester into the **READY** status.

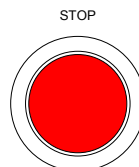

- The ZERO function can be activated by pressing the corresponding soft-key in the READY status. The ZERO soft-key will be highlighted.



- Press the START button to perform the zero check. The tester will go into the ZERO status.

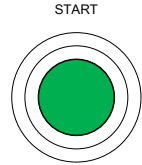

- The TEST indicator will be lit orange when in the ZERO status.

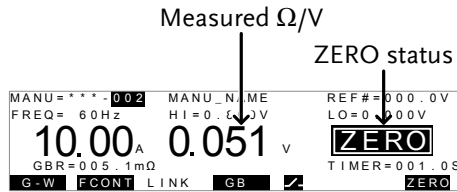

- When the zero check has finished, the tester will return back to the VIEW status. The resistance of the test leads will be automatically set as the Reference value.

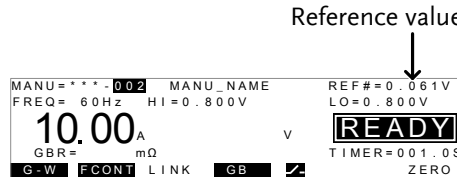

**Note**

Remember to replace the test leads to the proper position on the DUT before testing.

**I<SET**

If SOURCE H/L terminals are open or poorly connected, then an I<SET error will appear on the screen. Stop the test and re-check the connection again and try again.

I<SET error message

FAIL status



**R = 0**

Stop the test and perform the zero check again.

R = 0 error message

FAIL status

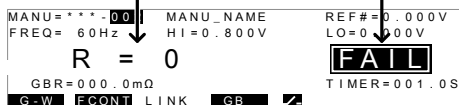

## Linked ACW/DCW/IR Tests

This section describes how to perform additional ACW, DCW or IR tests with a slave GPT-9XXX unit using the GCT-9040 as the master unit. ACW and DCW tests can be performed before, after or simultaneously with a GB test. IR tests can only be performed before or after a GB test.

The LINK port on the GCT-9040 is used to control the linked slave unit. The slave unit can be used in MANU or AUTO mode, depending on the setup. In addition, remote commands can also be issued to slave units via the GCT-9040.

- LINK Connection → from page 58
- LINK Test Configuration → from page 60
- Run LINK Test → from page 63

Before operating the GCT-9040 please read the safety precautions as outlined in the Set Up chapter on page 19 as well as the safety information in the user manuals' of the GPT-9XXX units that function as the slave units when using the link connection.

## LINK Connection

---

**Background** Any GPT-98XX or GPT-99XX unit can be used in conjunction with the GCT-9040 to perform additional ACW, DCW or IR tests.

The LINK port on the GCT-9040 and the RS-232 port on the slave unit is used to connect both devices. The GPT-9XXX interface should be configured to the RS-232, with a baud of 115200.

---

- Steps**
1. Ensure the power is off on both the GCT-9040 and the GPT-9XXX slave unit.
  2. Connect the LINK cable (GTL-132) to the LINK port on the GCT-9040 and to the RS-232 port on the GPT-9XXX unit.
  3. Connect the DUT as shown on page 30.

Note: Stack the units vertically to use the cable.

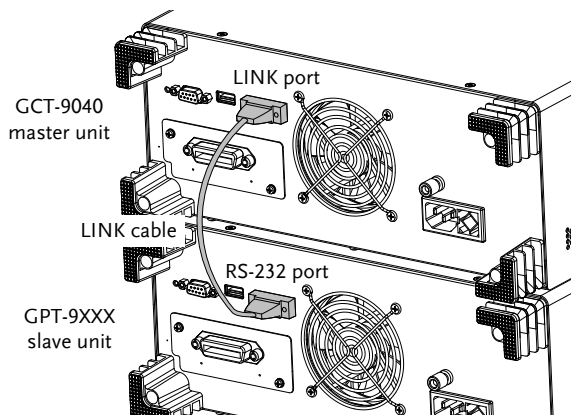



Note

No more than 2 units should be stacked vertically.

---

## LINK Test Configuration



Note

First ensure the GPT-9XXX interface s set to RS-232 and that the baud rate is set to 115200. See the Remote Control chapter of the corresponding user manual for configuration details. Not setting the interface correctly will result in failure of the LINK mode connection.

Steps

1. Turn on both units after the link cable has been connected\*.
2. The GCT-9040 will be in VIEW mode upon startup.



Note

\*The GCT-9040 will perform a search to see if a slave unit is connected with the LINK cable upon startup. If the slave GPT-9XXX is found then the LINK connection will automatically be activated at startup. Note, however, that the GPT-9XXX unit will need to have been fully powered on before the GCT-9040 is powered on for the search to succeed.

Load GB Test

3. Use the scroll wheel on the GCT-9040 to select a MANU test number. This will be the GB test used.

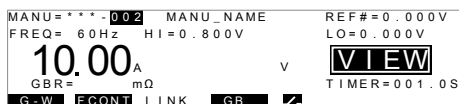
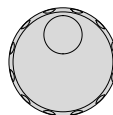

4. The GPT-9XXX unit will automatically go into the RMT-VIEW status upon startup when connected with the link cable. The last used MANU or AUTO mode test will be loaded on startup.

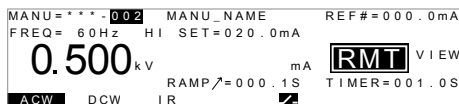

(GPT-9XXX screen)

- Load ACW, DCW, IR Test
5. If you need to select a different ACW, DCW or IR test, follow the steps below on the GPT-9XXX:

- a. Press the STOP button on the GPT-9XXX to exit from remote mode and return the unit to READY status.

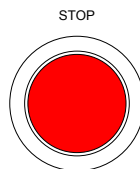

- b. Press the MANU/AUTO key to select a MANU test.



OR

Hold the MANU/AUTO key to select an AUTO test.

- c. Use the scroll wheel to select the desired MANU or AUTO test.

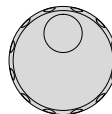



6. Press the LINK soft-key on the GCT-9040 if the LINK connection is not already activated.

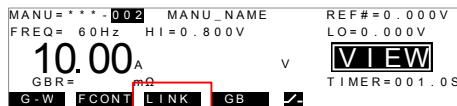

The LINK soft-key will be highlighted when the LINK connection is active.



The GPT-9XXX will enter the RMT-VIEW mode if it wasn't already.

- On the GCT-9040 press the F1 soft- key to toggle the order of the  testing mode:



G+W Simultaneously test GB with ACW or DCW. IR is not supported in this mode.

G-W GB then ACW/DCW/IR test.

W-G ACW/DCW/IR then GB test.

G GB test only.

W ACW/DCW/IR test only.

- Press the F2 soft-key to set the test  FAIL behavior: 

FCONT If a test is judged FAIL, the tester will continue to the next test.

FSTOP If a test is judged FAIL, the test will stop.

## Run LINK Test

---

**Background**                      The operation for running a linked test is the same as running a single GB test.

---



Note

The tester cannot start to run a test under the following conditions:

- Any protection modes have been tripped.
- The INTERLOCK function is ON and the Interlock key is not inserted in the signal I/O port (page 80).
- The STOP signal has been received remotely.

If Double Action is ON, ensure the START button is pressed immediately after the STOP button (<0.5s).

---



Warning

Do not touch any terminals, test leads or the DUT when a test is running.

---

**Start Testing**

1. Press the STOP button on the GCT-9040 to put the tester into READY status if it is not already (from the VIEW status).

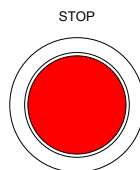

2. Press the START button on the GCT-9040 to start the LINK tests.

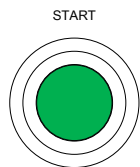

TEST will be displayed on the screen of the GCT-9040 or GPT-9XXX when a particular test is being run:

**GCT-9040 (GB) Test Example:**



**GPT-9XXX (ACW/DCW/IR) Test Example:**

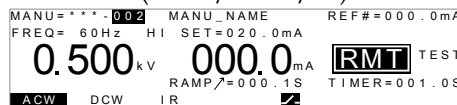

How the tests are performed depends on the testing mode:

- G+W Simultaneously run the ground bond and the first ACW or DCW test. Any remaining tests on the slave unit will then run. IR is not supported in this mode.

---

- G-W The ground bond test will run first followed by the ACW/DCW/IR manual or AUTO test(s).

---

- W-G ACW/DCW/IR manual or AUTO test(s) run first followed by the ground bond test.

---

- G Runs the ground bond test only.

---

- W Runs ACW/DCW/IR tests only.

Stop a Running Test

3. To stop the LINK test at any time when it is running, press the STOP button. The current test will stop immediately. When the STOP button is pressed, a judgment is not made on the current test and any remaining tests are aborted.

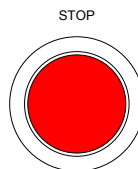

- To put the tester back into READY status, press the STOP button again.

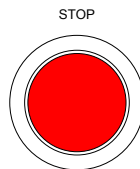

**Exit Testing**

To exit testing, press the MANU key on the GCT-9040 when the tester is in the READY status. The tester will revert to the VIEW status for the current test.



All panel keys except the STOP and START buttons are locked when the tester has been stopped.

All the results up until when the test was stopped are shown on-screen; GB results on the GCT-9040 screen, ACW/DCW/IR results on the GPT-9XXX slave unit.

Please see page 51 to see the PASS/FAIL details for GB tests. Please see the GPT-9XXX user manual for PASS/FAIL details for ACW, DCW and IT MANU/AUTO tests.

## Common Utility Settings

The Common Utility settings are system-wide settings that apply to all the MANU tests.

The Common Utility menu includes the following settings:

- LCD Settings → from page 66.
- Buzzer Settings → from page 67.
- Interface Settings → from page 68.
- Control Settings → from page 70.
- Signal Time Settings → from page 72.

### LCD Settings

---

Description	The LCD settings include contrast and brightness controls.
-------------	--

Steps	1. Ensure the tester is in VIEW status. Page 26 Save the current test if necessary.
-------	--

2. Press the UTILITY key.



3. Press the LCD soft-key to bring up the LCD Common Utility menu.



4. Use the UP/DOWN arrow keys to choose a menu item: LCD Contrast, LCD Brightness.



- Use the scroll wheel to select a parameter for the chosen menu item.

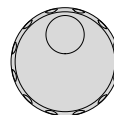

LCD Contrast      1(low) ~ 8(high)  
 LCD Brightness    BRIGHT, DARK

- Press EDIT/SAVE to save the settings and exit to VIEW status.



Note

The ESC key can be pressed at any time to cancel and exit back to VIEW status.

## Buzzer Settings

**Description**      The Buzzer settings allow you to set whether the buzzer will sound for PASS/FAIL judgments. The buzzer time can also be set for the PASS/FAIL judgments. The buzzer settings are system-wide.

- Steps**
- Ensure the tester is in VIEW status. Page 26  
 Save the current test if necessary.



- Press the UTILITY key.



- Press the BUZZ soft-key to bring up the Buzzer Common Utility menu.



4. Use the UP/DOWN arrow keys to choose a menu item: Pass Sound or Fail Sound.
 

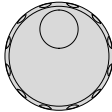

  
5. Use the scroll wheel to select a parameter for the chosen menu item.
 



Pass Sound            ON (000.2s~999.9s), OFF

Fail Sound            ON (000.2s~999.9s), OFF
  
6. Press EDIT/SAVE to save the settings and exit to the VIEW status.
 





Note

For linked tests, the Pass Sound and Fail Sound settings also apply to the overall PASS/FAIL of the *all tests*, not just each individual test.



Note

The ESC key can be pressed at any time to cancel and exit back to VIEW status.

## Interface Settings

Description

The interface settings choose the remote interface configuration. USB and GPIB (optional) can be selected.

Steps

1. Ensure the tester is in VIEW status. [Page 26](#)  
Save the current test if necessary.
  
2. Press the UTILITY key.
 

  
3. Press the INTER soft-key to bring up the Interface Common Utility menu.
 





Note

By default the interface is fixed to USB with a baud of 115200 when the GPIB interface is not installed.

4. Use the scroll wheel to select USB, or GPIB (if installed).

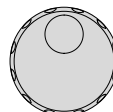

5. For GPIB, use the UP/DOWN arrow keys to choose Address.



6. Use the scroll wheel to select the GPIB address.

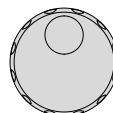

GPIB address 0~30

7. Press EDIT/SAVE to save the settings and exit to VIEW status.



Note

Ensure the GPIB address matches the host machine.



Note

The ESC key can be pressed at any time to cancel and exit back to VIEW status.

## Control Settings

---

Description	<p>The Control settings are accessed in the COMMON UTILITY menu. The Control settings include: Start Control, Double Action, Key Lock and Interlock.</p> <p>Start Control is used to determine how a test is started. Tests can be started via the front panel (START/STOP buttons), from a remote controller or via the SIGNAL I/O port.</p> <p>The Double Action function is a safety feature used to prevent accidentally starting a test. Normally to start a test, the START button is pressed when the tester is in the READY status. To start a test when Double Action is ON, the STOP button must first be pressed, followed by the START button within 500ms.</p> <p>Key Lock disables the front panel keys from changing the test number, mode or testing parameters. Only the Utility menu and any keys required for testing are not disabled.</p> <p>The Interlock function is a safety feature. The interlock function prevents a test from running, unless the interlock pins on the signal I/O port connector are shorted. The included interlock key can be used for this purpose. See page 80 for details.</p>
Steps	<ol style="list-style-type: none"><li data-bbox="336 1278 885 1337">1. Ensure the tester is in VIEW status. Page 45 Save the current test if necessary.</li><li data-bbox="336 1378 645 1406">2. Press the UTILITY key.</li></ol>



3. Press the CTRL soft-key to bring up the Control Common Utility menu.

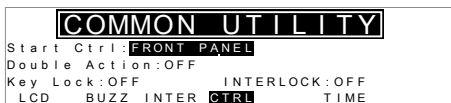

4. Use the UP/DOWN arrow keys to choose a menu item: Start Ctrl, Double Action, Key Lock or INTERLOCK.

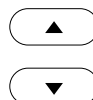

5. Use the scroll wheel to select the setting for the chosen menu item.

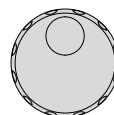

Start Ctrl	FRONT PANEL, REMOTE CONNECT, SIGNAL IO
Double Action	ON, OFF
Key Lock	ON, OFF
INTERLOCK	ON, OFF

6. Press EDIT/SAVE to save the settings and exit to VIEW status.



Note

The Double Action setting is ignored when the GCT-9040 is being controlled remotely using the USB or GPIB interfaces.



Note

If a test is started with INTERLOCK ON, but the interlock signal I/O pins are not shorted (either with the included interlock key or manually), the INTERLOCK OPEN message will be displayed, preventing the test from starting.

Interlock open message

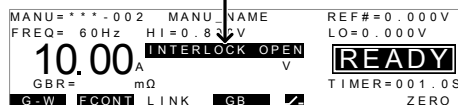

## Signal I/O Time Cut Settings

### Description

The Signal I/O Time Cut setting determines how the I/O fail signal is output for a FAIL or PASS judgment.

When set to OFF, the fail/pass signal stays low on a judgment.

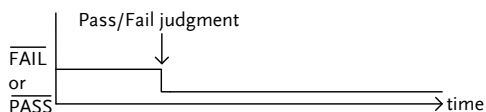

When turned ON, the fail/pass signal is pulsed (active low) for the duration of the signal I/O time cut time + buzzer fail or pass time (see page 67).

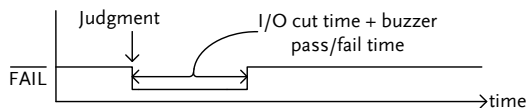

### Steps

1. Ensure the tester is in VIEW status. Page 26  
Save the current test if necessary.

2. Press the UTILITY key.



3. Press the TIME soft-key to bring up the Time Common Utility menu.



4. Use the scroll wheel to set the time or to turn the option OFF.

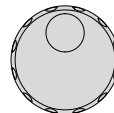

SIGNAL IO TIME CUT OFF, 000.1 ~ 999.9

5. Press EDIT/SAVE to save the settings and exit to VIEW status.



Note

The ESC key can be pressed at any time to cancel and exit back to VIEW status.

# E EXTERNAL CONTROL

The External Control chapter covers the  
REMOTE terminal and the SIGNAL I/O port.

---

<b>External Control Overview .....</b>	<b>75</b>
Remote Terminal Overview .....	75
Remote Controller Operation .....	76
SIGNAL I/O Overview .....	77
Using the SIGNAL I/O to Start/Stop Tests .....	79
Using the Interlock Key .....	80

## External Control Overview

The External Control section describes the front panel REMOTE terminal connection and the rear panel SIGNAL I/O port.

### Remote Terminal Overview

**Overview** The REMOTE terminal connector is a standard 5-pin DIN terminal suitable for a remote controller.

 **WARNING** Keep any cables that are connected to the REMOTE terminal away from the Source and Sense terminals.

#### Pin Assignment and Connection

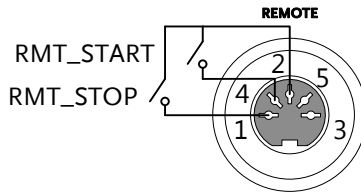

Pin	Pin name	Description
1	RMT_STOP	Remote Stop signal
2	COM	Common line
3	Not used	
4	RMT_START	Remote Start signal
5	Not used	
Signal Properties		
	High level input voltage	2.4V~3.3V
	Low level input voltage	0~0.8V
	Input period	Minimum of 1ms

## Remote Controller Operation

**Description**                      The GCT-9040 accepts external remote controllers with a START and STOP button. To use the REMOTE terminal, the GCT-9040 must first be configured to accept a remote controller.

Operating a remote controller is the same as operating the START and STOP buttons on the front panel.

- Steps**
1. Insert the lead of the remote controller into the REMOTE terminal.
  2. Configure the Start Ctrl option to REMOTE CONNECT in the Common Utility menu.
  3. The tester will now only be able to start a test using a remote controller.

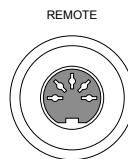

Page 70

 **NOTE**

Even if the GCT-9040 is configured to use the REMOTE CONNECT option, the STOP button on the front panel can still be used to stop a test.

4. To return the operation control to the front panel, configure the Start Ctrl option to FRONT PANEL.      Page 70

## SIGNAL I/O Overview

**Overview**                      The SIGNAL I/O port can be used to remotely start/stop tests and monitor the test status of the instrument. The SIGNAL I/O port is also used for the interlock function (page 70).

The SIGNAL I/O port uses a DB-9 pin female connector.

### Pin Assignment

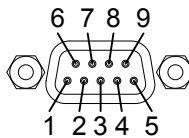

Pin name	Pin	Description
INTERLOCK1	1	When INTERLOCK is ON, a test is only allowed to start when both INTERLOCK pins are shorted.
INTERLOCK2	2	
INPUT_COM	3	Common input line
INPUT_START	4	Start signal input
INPUT_STOP	5	Stop signal input
OUTPUT_TEST	6	Indicates that a test is in progress
OUTPUT_FAIL	7	Indicates that a test has failed
OUTPUT_PASS	8	Indicates that a test has passed
OUTPUT_COM	9	Common output line

### Interlock connection

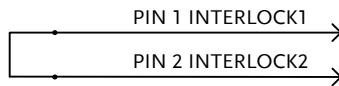

### Input Connection

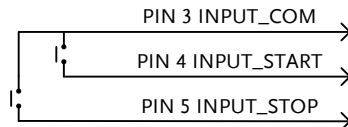

Output  
Connection

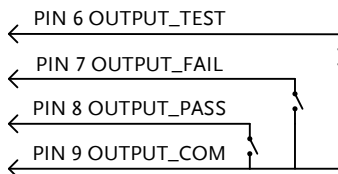

Signal Properties

Input Signals	
High level input voltage	5V ~ 32V
Low level input voltage	0V ~ 1V
Low level input current	Maximum of -5mA
Input period	Minimum of 1ms
Output Signals	
Output Type	Relay form A
Output Rated Voltage	30VDC
Maximum output current	0.5A

## Using the SIGNAL I/O to Start/Stop Tests

---

Background                      To use the SIGNAL I/O port, the Start Ctrl settings have to be set to SIGNAL I/O in the Common Utility menu.

---

- Panel operation
1. Set the Start Ctrl option to SIGNAL Page 70 I/O.
  2. Connect the Input/Output signals to the SIGNAL I/O port.
  3. To start the testing, short the INPUT\_STOP and INPUT\_COM line for a minimum of 1ms to put the tester into READY status.
  4. To start the testing, short the INPUT\_START and INPUT\_COM lines for a minimum of 1ms.
  5. To stop the testing, temporarily short the INPUT\_STOP and INPUT\_COM line again.
- 



Even if the GCT-9040 is configured to use the SIGNAL I/O interface, the STOP button on the front panel can still be used to stop a test.

---

## Using the Interlock Key

---

**Background** When the INTERLOCK function is set to ON, tests are only allowed to start when both Interlock pins on the signal I/O port are shorted. Using the Interlock key will short the INTERLOCK1 and INTERLOCK2 pins on the signal I/O port. See page 77 for the Signal I/O pin assignment.

---

**Panel operation** 1. Insert the Interlock key into the SIGNAL I/O port on the rear panel.

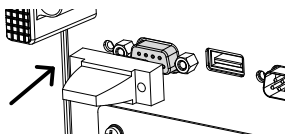

2. Set the INTERLOCK option to ON Page 70 in the Common Utility.

---



With INTERLOCK set to ON, the tester can now only start a test when the Interlock key is connected. Do not remove the interlock after starting a test. It must be still be connected after a test has started or is running.

Set INTERLOCK to OFF to disable this feature.

---

# REMOTE CONTROL

This chapter describes basic configuration of IEEE488.2 based remote control. The remote interface supports USB and GPIB.

---

Interface Configuration .....	82
Command Syntax .....	86
Command List .....	89
Error Messages .....	128

# Interface Configuration

## USB Remote Interface

USB Configuration	PC side connector	Type A, host
	GCT-9040 side connector	Rear panel Type A
	USB Class	CDC (communications device class) (VCP, Virtual Com Port)

- Panel operation
1. Connect the USB cable to the rear panel USB A port. 
  2. Set the interface to USB from the Common Utility menu. [Page 68](#)



When USB is used for remote control, an RS232 port is simulated. Check the Windows Device Manager for the baud rate and other RS232 settings.

Note the baud rate is fixed to 115200 baud when using the USB interface.

## GPIB Remote Interface

The GPIB card is an optional extra. Please see page 21 for installation details.

GPIB Configuration	Address	0-30
--------------------	---------	------

- Panel operation
1. Connect the GPIB cable to the rear panel GPIB port.
  2. Set the interface to GPIB and set the GPIB address from the Common Utility menu.



Page 68

## USB Remote Control Function Check

Functionality check      Invoke a terminal application such as Hyper Terminal.

To check the COM port number and other settings, see the Device Manager in the PC. For Windows 7; Control panel → Hardware and Sound → Device Manager.

Run this query command via the terminal after the instrument has been configured for USB remote control (page 82).

\*idn?

This should return the Model number, Serial number, and Firmware version in the following format:

GCT-9040, XXXXXXXXXXXXX, V1.00

Model number : GCT-9040  
 Serial number :12 character serial number  
 Firmware version : V1.00

**Display** When the panel is being remotely controlled via the USB or GPIB interfaces, RMT will be displayed on the screen.



## Return to Panel Control

---

**Background** When the instrument is remotely controlled, all panel keys except the STOP button are disabled.

**Steps** 1. When RMT is on the display, press the STOP button. The panel goes to the READY status.

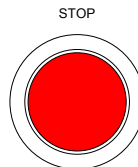

2. From the READY status the tester can go into one of two states: TEST or VIEW.

- To put the tester into VIEW status, press the MANU key.



- To put the tester in TEST status, press the START button. This will start the manual test. For more details on running a manual test, see page 47.

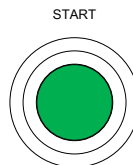



Note

To put the tester back to RMT, simply issue another remote control command.

---

## Command Syntax

Compatible Standard	IEEE488.2	Partial compatibility
	SCPI, 1999	Partial compatibility

**Command Structure**  
 SCPI commands follow a tree-like structure, organized into nodes. Each level of the command tree is a node. Each keyword in an SCPI command represents each node in the command tree. Each keyword (node) of an SCPI command is separated by a colon (:).

For example, the diagram below shows an SCPI sub-structure and a command example.

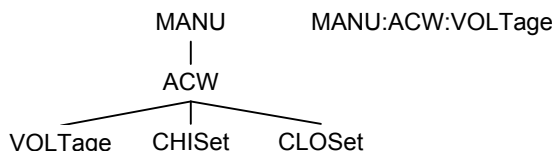

**Command types**  
 There are a number of different instrument commands and queries. A command sends instructions or data to the unit and a query receives data or status information from the unit.

**Command types**

**Setting**                      A single or compound command with/without a parameter

**Example**                      MANU:STEP 1



	<NR3>	floating point	4.5e-1, 8.25e+1
	<NRf>	any of NR1, 2, 3	1, 1.5, 4.5e-1
	<string>	ASCII text string	TEST_NAME
Message Terminator	CR, LF	Carriage Return, Line feed code	

---

## Command List for GCT-9040

---

System	FAIL:STOP .....	92	
Commands	SYSTem1:BUZZer:PSOUND .....	92	
	SYSTem1:BUZZer:FSOUND .....	93	
	SYSTem1:BUZZer:PTIME .....	93	
	SYSTem1:BUZZer:FTIME .....	93	
	SYSTem:ERRor .....	94	
	SYSTem1:ERRor .....	95	
	SYSTem:GPIB:VERSion .....	96	
	SYSTem:LCD:CONTrast .....	96	
	SYSTem:LCD:BRIGhtness .....	96	
	SYSTem:LINK .....	97	
	SYSTem:TEST:MODE .....	97	
	SYSTem:TIME:CUT .....	98	
	SYSTem1:TIME:CUT .....	98	
	Function Commands	FUNCTion:TEST .....	99
		FUNCTion1:TEST .....	100
MEASure<x> .....		100	
MAIN1:FUNCTion .....		101	
Manual Commands	MANU:STEP .....	104	
	MANU1:STEP .....	104	
	MANU:NAME .....	104	
	MANU1:RTIME .....	105	
	MANU<x>:EDIT:SLAVe? .....	105	
	MANU1:EDIT:MODE .....	106	
	MANU1:ACW:VOLTag .....	106	
	MANU1:ACW:CHISet .....	107	
	MANU1:ACW:CLOSet .....	107	
	MANU1:ACW:TTime .....	108	
	MANU1:ACW:FREQuency .....	109	
	MANU1:ACW:REF .....	109	
	MANU1:ACW:ARCCurrent .....	110	
MANU1:DCW:VOLTag .....	110		

MANU1:DCW:CHISet.....	111
MANU1:DCW:CLOSet.....	111
MANU1:DCW:TTime.....	112
MANU1:DCW:REF .....	113
MANU1:DCW:ARCCurrent .....	113
MANU1:IR:VOLTag .....	114
MANU1:IR:RHISet.....	114
MANU1:IR:RLOSet.....	115
MANU1:IR:TTime .....	115
MANU1:IR:REF .....	116
MANU:GB:CUTMode .....	116
MANU:GB:CURREnt .....	117
MANU:GB:RHISet .....	117
MANU:GB:RLOSet .....	118
MANU:GB:VHISet .....	118
MANU:GB:VLOSet .....	119
MANU:GB:TTime .....	119
MANU:GB:FREQuency .....	120
MANU:GB:REF.....	120
MANU:GB:ZEROCHECK.....	121
MANU1:UTILity:ARCMODE.....	121
MANU1:UTILity:PASShold.....	122
MANU1:UTILity:FAILmode .....	122
MANU1:UTILity:MAXHold .....	122
MANU1:UTILity:GROUNDMODE.....	123
MANU<x>:EDIT:SHOW .....	123
TESTok:RETurn.....	124
Auto Commands TESTok:RETurn.....	124
Common *CLS.....	125
Commands *IDN .....	125
*IDN1 .....	125

Remote	*RMTOFF.....	127
Commands		
Special Functions	InterLock Key Open.....	127

## System Commands

FAIL:STOP .....	92
SYSTem1:BUZZer:PSOUND .....	92
SYSTem1:BUZZer:FSOUND .....	93
SYSTem1:BUZZer:PTIME .....	93
SYSTem1:BUZZer:FTIME .....	93
SYSTem:ERRor .....	94
SYSTem1:ERRor .....	95
SYSTem:GPIB:VERSion .....	96
SYSTem:LCD:CONTRast .....	96
SYSTem:LCD:BRIGHtness .....	96
SYSTem:LINK .....	97
SYSTem:TEST:MODE .....	97
SYSTem:TIME:CUT .....	98
SYSTem1:TIME:CUT .....	98

### FAIL:STOP

Set →  
 → Query

Description	Sets or queries the FAIL behavior of the test. FSTOP will stop the test after a FAIL judgment. FCONT will continue the test after a FAIL judgment.	
Syntax	FAIL:STOP{ON OFF}	
Query Syntax	FAIL:STOP?	
Parameter/ Return parameter	ON	Sets the FAIL behavior to FSTOP.
	OFF	Sets the FAIL behavior to FCONT.
Example	FAIL:STOP ON Sets the FAIL behavior to FSTOP.	

Set →  
 → Query

### SYSTem1:BUZZer:PSOUND

Description	Turns the buzzer sound on or off for a PASS judgment for the slave.
-------------	---

Syntax	SYSTem1:BUZZer:PSOUND{ON OFF}	
Query Syntax	SYSTem1:BUZZer:PSOUND ?	
Parameter/ Return parameter	ON	PASS Sound on.
	OFF	PASS Sound off.
Example	SYST1:BUZZ:PSOUND ON Turns the buzzer sound on for PASS judgments.	

Set →

→ Query

### SYSTem1:BUZZer:FSOUND

Description	Turns the buzzer sound on or off for a FAIL judgment for the slave.	
Syntax	SYSTem1:BUZZer:FSOUND{ON OFF}	
Query Syntax	SYSTem1:BUZZer:FSOUND ?	
Parameter/ Return parameter	ON	FAIL Sound on.
	OFF	FAIL Sound off.
Example	SYST1:BUZZ:FSOUND ON Turns the buzzer sound on for FAIL judgments.	

Set →

→ Query

### SYSTem1:BUZZer:PTIME

Description	Sets the PASS sound duration in seconds for the slave.	
Syntax	SYSTem1:BUZZer:PTIME <NR2>	
Query Syntax	SYSTem1:BUZZer:PTIME?	
Parameter/ Return parameter	<NR2>	0.2~999.9
Example	SYST1:BUZZ:PTIM 1 Sets the buzzer to 1 second for a PASS judgment.	

Set →

→ Query

### SYSTem1:BUZZer:FTIME

Description	Sets the FAIL Sound duration in seconds for the slave.	
-------------	--	--

Syntax	SYSTem1:BUZZer:FTIME <NR2>
Query Syntax	SYSTem1:BUZZer:FTIME?
Parameter/ Return parameter	<NR2> 0.2~999.9
Example	SYST1:BUZZ:FTIM 1 Sets the buzzer to 1 second for a FAIL judgment.

**SYSTEM:ERRor**

→ Query

Description	Returns any errors in the output buffer for the GCT-9040. See the error code table below for details.
Query Syntax	SYSTEM:ERRor ?
Return parameter	<string> Returns an error string that includes an error code and an error description.

**Error Code Table**

Error code, Error description

- 0, No Error
- 20, Command Error
- 21, Value Error
- 22, String Error
- 23, Query Error
- 24, Mode Error
- 27, GBV > 7.2V
- 31, Current Setting Error
- 34, Resistance HI SET Error
- 35, Resistance LO SET Error
- 36, REF Setting Error
- 37, Frequency Setting Error
- 40, TEST Time Setting Error
- 41, LINK Setting Error (LINK GPT-9800/9900 Error)
- 42, Voltage HISet Error (GCT-9040 CUT V HI SET Error)
- 43, Voltage LOSet Error (GCT-9040 CUT V LO SET Error)
- 45, Buffer Error (Command buffer overflow)

Example	SYST:ERR ? >0, No Error Returns "0, No Error" as the error message.
---------	---

## SYSTEM1:ERRor

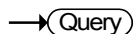

Description	Returns any errors in the output buffer of the slave GPT-9XXX unit. See the error code table below for details.
-------------	---

Query Syntax SYSTem1:ERRor ?

Return parameter	<string>	Returns an error string that includes an error code and an error description.
------------------	----------	---

### Error Code Table

#### Error code, Error description

0, No Error
20, Command Error
21, Value Error
22, String Error
23, Query Error
24, Mode Error
25, Time Error
26, DC Over 50W (GPT-98XX), DC Over 100W (GPT-99XX/99XXA)
27, GBV > 5.4V
30, Voltage Setting Error
31, Current Setting Error
32, Current HI SET Error
33, Current LO SET Error
34, Resistance HI SET Error
35, Resistance LO SET Error
36, REF Setting Error
37, Frequency Setting Error
38, ARC Setting Error
39, RAMP Time Setting Error
40, TEST Time Setting Error
45, Buffer Error

60,Get Data = 0 (GPT-9900 only get SWEEP Data)

Example SYST1:ERR ?  
 >0,No Error  
 Returns "0,No Error" as the error message.

**SYSTEM:GPIB:VERSION** → Query

Description	Queries the GPIB version.	
Query Syntax	SYSTEM:GPIB:VERSION?	
Return parameter	<string>	Returns: The GPIB version as a string "GPIB,V1.00" or "No GPIB connected" if there is not a GPIB device configured/connected.

Query Example SYST:GPIB:VERS?  
 >GPIB,V1.00  
 Returns the GPIB version.

Set →

**SYSTEM:LCD:CONTRast** → Query

Description	Sets the contrast of the LCD display from 1 (low) to 8 (bright).	
Syntax	SYSTEM:LCD:CONTRast <NR1>	
Query Syntax	SYSTEM:LCD:CONTRast?	
Parameter/ Return parameter	<NR1>	1~8

Example SYST:LCD:CONT 5  
 Sets the display contrast to 5.

Set →

**SYSTEM:LCD:BRIGHtness** → Query

Description	Sets the brightness of the LCD display from 1(dark) to 2(bright).	
-------------	---	--

Syntax	SYSTem:LCD:BRIGhtness <NR1>
Query Syntax	SYSTem:LCD:BRIGhtness?
Parameter/ Return parameter	<NR1> 1 (dark), 2 (bright)
Example	SYST:LCD:BRIG 2 Sets the display brightness to bright.

**SYSTEM:LINK**

Set →

Description	This is command performs two functions. 1. It will activate the LINK connection. 2. It will then return the status of the LINK connection.
Note	First connect the GCT-9040 to the GPT-9800/9900 series before using this command.  This command cannot be used to deactivate the LINK connection.
Syntax	SYSTem:LINK
Return parameter	ON LINE Link is on line OFF LINE Link is off line
Example	SYST:LINK >ON LINE

Set →

→ Query

**SYSTEM:TEST:MODE**

Description	Sets the testing mode (G+W, G-W, W-G, G, W).
Syntax	SYSTem:TEST:MODE { GandW GtoW WtoG Gonly Wonly}
Query Syntax	SYSTem:TEST:MODE?
Parameter/ Return parameter	GandW Ground bond + Withstanding GtoW Ground bond then Withstanding WtoG Withstanding then Ground bond Gonly Ground bond only Wonly Withstanding only

Example            SYSTem:TEST:MODE GandW  
                      Sets the mode to G+W.

Set →

**SYSTem:TIME:CUT**

→ Query

Description       Sets or queries the signal I/O time cut settings for the GCT-9040.

Syntax            SYSTem:TIME:CUT <NR2>|OFF

Query Syntax     SYSTem:TIME:CUT?

Parameter/       <NR2>    0~999.9

Return parameter OFF       OFF

Example           SYST:TIME:CUT?  
                      >OFF

Set →

**SYSTem1:TIME:CUT**

→ Query

Description       Sets or queries the signal I/O time cut settings for the slave\*.  
                      \*Only available for models with customized firmware.

Syntax            SYSTem1:TIME:CUT <NR2>|OFF

Query Syntax     SYSTem1:TIME:CUT?

Parameter/       <NR2>    0~999.9

Return parameter OFF       OFF

Example           SYST1:TIME:CUT?  
                      >OFF

## Function Commands

FUNcTION:TEST .....	99
FUNcTION1:TEST .....	100
MEASure<x> .....	100
MAIN1:FUNcTION.....	101

### FUNcTION:TEST

Set →

→ Query

**Description** Turns the currently selected test (output) on or off for the GCT-9040. If a slave is connected using the LINK cable, its output will also turn on, according to the order of the test settings (G+W, G-W, W-G, G, W).

Setting the FUNcTION:TEST command to OFF at the end of a test will also temporarily turn the PASS/FAIL buzzer sound off.

Note: Setting the FUNcTION:TEST command to OFF will not turn the test off for a connected slave unit. Please use the FUNcTION1:TEST OFF command.

**Syntax** FUNcTION:TEST {ON|OFF}

**Query Syntax** FUNcTION:TEST?

<b>Parameter</b>	ON	Turns the test on.
	OFF	Turns the test off.

<b>Return parameter</b>	TEST ON	Test is on.
	TEST OFF	Test is off.

**Example** FUNC:TEST ON  
Turns the output on.

Set →

→ Query

**FUNCTION1:TEST**

**Description** Turns the currently selected test (output) on or off for a slave GPT-9XXX.

Setting the FUNCTION:TEST command to OFF at the end of a test will also temporarily turn the PASS/FAIL buzzer sound off.

**Syntax** FUNCTION1:TEST {ON|OFF}

**Query Syntax** FUNCTION1:TEST?

<b>Parameter</b>	ON	Turns the test on for the slave unit.
	OFF	Turns the test off on for the slave unit.

<b>Return parameter</b>	TEST ON	Test is on for the slave unit.
	TEST OFF	Test is off for slave unit.

**Example** FUNC1:TEST ON  
Turns the output on for the slave unit.

**MEASure<x>**

→ Query

**Description** Returns the test parameters & results of the tester.

MANU mode: Returns the test parameters & results of a MANU test for both the GCT-9040 and the slave, if connected.

AUTO mode: Returns the test parameters & results of the selected step (1-16) of the AUTO test of the slave, if connected.

Return parameters: function, judgment/status, test voltage, test current/resistance, test time (time of completed test) or ramp time (elapsed time of test that has not been completed).

**Query Syntax** MEASure<x>?

<b>Parameter (MANU mode)</b>		No parameter needed for MANU mode.
------------------------------	--	------------------------------------

Parameter (AUTO mode)	<x>	<NR1>1~16. Step number.
Return parameter	<string>LN <string>	Returns a string with the test status of the GCT-9040 test, followed by another string of the slave test, if connected, in the following format: function, judgment or status, test voltage, test current or resistance, test time or ramp time
	Function	ACW, DCW, IR, GB
	Judgment /Status	PASS, FAIL VIEW
	Test voltage	voltage+unit
	Test current /Test resistance	current+unit resistance+unit
	Test time /Ramp time	T=time+S R=time+S

Example (in MANU mode) MEAS?  
 > GB ,PASS ,03.00A ,000.0mohm,T=001.0S  
 ACW, FAIL , 0.024kV ,0.013 mA ,R=000.1S  
 Returns the test result of the current manual test first (1<sup>st</sup> line) then the slave manual test(2<sup>nd</sup> line), if connected.

Example (in AUTO mode) MEAS10?  
 >IR, FAIL ,0.225kV ,999M ohm,T=010.3S  
 Returns step 10 of the automatic result of the connected slave unit.

**MAIN1:FUNCTION**

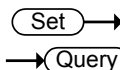

Description	Changes the mode between AUTO and MANU on the slave unit when in LINK mode.
Syntax	MAIN1:FUNCTION {MANU AUTO}
Query Syntax	MAIN1:FUNCTION?

Parameter/	MANU	Puts the tester mode to MANU.
Return parameter	AUTO	Puts the tester mode to AUTO.
Example	MAIN1:FUNC MANU Sets the tester to MANU mode for the slave unit.	

## Manual Commands

---

MANU:STEP .....	104
MANU1:STEP .....	104
MANU:NAME.....	104
MANU1:RTIME .....	105
MANU<x>:EDIT:SLAVE? .....	105
MANU1:EDIT:MODE.....	106
MANU1:ACW:VOLTage.....	106
MANU1:ACW:CHISet.....	107
MANU1:ACW:CLOSet.....	107
MANU1:ACW:TTIME.....	108
MANU1:ACW:FREQuency .....	109
MANU1:ACW:REF .....	109
MANU1:ACW:ARCCurrent .....	110
MANU1:DCW:VOLTage.....	110
MANU1:DCW:CHISet.....	111
MANU1:DCW:CLOSet.....	111
MANU1:DCW:TTIME.....	112
MANU1:DCW:REF .....	113
MANU1:DCW:ARCCurrent .....	113
MANU1:IR:VOLTage .....	114
MANU1:IR:RHISet.....	114
MANU1:IR:RLOSet.....	115
MANU1:IR:TTIME .....	115
MANU1:IR:REF .....	116
MANU:GB:CUTMode .....	116
MANU:GB:CURREnt .....	117
MANU:GB:RHISet .....	117
MANU:GB:RLOSet .....	118
MANU:GB:VHISet .....	118
MANU:GB:VLOSet .....	119
MANU:GB:TTIME .....	119
MANU:GB:FREQuency .....	120
MANU:GB:REF.....	120
MANU:GB:ZEROCHECK.....	121
MANU1:UTILity:ARCMoDe.....	121
MANU1:UTILity:PASShold.....	122

MANU1:UTILity:FAILmode .....122  
 MANU1:UTILity:MAXHold.....122  
 MANU1:UTILity:GROUNDMODE.....123  
 MANU<x>:EDIT:SHOW .....123  
 TESTok:RETurn.....124

**MANU:STEP** (Set) →  
→ (Query)

Description	Sets the MANU test number for the GCT-9040.
Syntax	MANU:STEP <NR1>
Query Syntax	MANU:STEP?
Parameter/ Return parameter	<NR1> 0~100.
Example	MANU:STEP 100 Sets the manual test number to 100.

**MANU1:STEP** (Set) →  
→ (Query)

Description	Sets the MANU test number for the slave unit.
Syntax	MANU1:STEP <NR1>
Query Syntax	MANU1:STEP?
Parameter/ Return parameter	<NR1> 0~100.
Example	MANU1:STEP 100 Sets the manual test number to 100 for the slave unit.

**MANU:NAME** (Set) →  
→ (Query)

Description	Sets or returns the test name for the selected manual test. The test must be in MANU mode before this command can be used. Note only alphanumeric characters (A-Z, a-z, 0-9) and the “_” underscore character can be used to set the MANU test name.
-------------	---

Syntax	MANU:NAME <string>
Query Syntax	MANU:NAME?
Parameter/ Return parameter	<string> 10 character string. (first character must be a letter)
Example	MANU:NAME test1 Sets the manual test name to “test1”.

Set →

→ Query

### MANU1:RTIME

Description	Sets or returns the Ramp Time for the test in seconds for the slave unit when in LINK mode.  Note: A “TIME ERR” will result if the Ramp Time + Test Time is $\geq 240$ seconds when the HI SET limit is over 30mA (GPT-98XX) or over 80mA (GPT-99XX/99XXA). This applies to the ACW function only.
-------------	--

Syntax	MANU1:RTIME <NR2>
Query Syntax	MANU1:RTIME?
Parameter/ Return parameter	<NR2> 0.1~999.9 seconds
Example	MANU1:RTIM 0.5 Sets the ramp time to half a second for the slave unit.

### MANU<x>:EDIT:SLAVE?

→ Query

Description	Returns the test parameters of a manual test for the slave.
Query Syntax	MANU<x>:EDIT:SLAVE?
Parameter/ Return parameter	<x> <NR1> 000~100. Manual test number <string> Returns a string in the following format: Test function, test voltage, HI SET value, LO SET value, Ramp time, test time.

**Example**                    MANU1:EDIT:SLAV ?  
                                  > ACW,0.100kV,H=01.00mA,L=00.00mA,R=000.1S,  
                                  >T=001.0S.  
                                  Returns the test parameters of manual test number 1.

(Set) →

**MANU1:EDIT:MODE**

→ (Query)

**Description**                Sets or returns the mode (ACW, DCW, IR) of the selected manual test for the slave unit when in LINK mode.

**Syntax**                     MANU1:EDIT:MODE {ACW|DCW|IR}

**Query Syntax**             MANU1:EDIT:MODE?

**Parameter/**                ACW            AC Withstand mode

**Return parameter**        DCW            DC Withstand mode

IR                            Insulation Resistance mode

**Example**                    MANU1:EDIT:MODE ACW  
                                  Sets the mode to ACW for the slave unit.

(Set) →

**MANU1:ACW:VOLTage**

→ (Query)

**Description**                Sets or returns the ACW voltage in kV for the slave unit when in LINK mode. The test must first be in ACW mode before this command can be used.

**Syntax**                     MANU1:ACW:VOLTage <NR2>

**Query Syntax**             MANU1:ACW:VOLTage?

**Parameter/**                <NR2>        0.100 ~ 5.000 (kV)

**Return parameter**        [ ]

**Example**                    MANU1:ACW:VOLT 1  
                                  Sets the ACW voltage to 1 kV for the slave unit.

## MANU1:ACW:CHISet

Set →

→ Query

**Description** Sets or returns the ACW HI SET current value in milliamps for the slave unit when in LINK mode. The test must first be in ACW mode before this command can be used.

**Syntax** MANU1:ACW:CHISet <NR2>

**Query Syntax** MANU1:ACW:CHISet?

<b>Parameter/ Return parameter</b>	<NR2>	0.001 ~ 042.0 (GPT-98XX)
		0.001 ~ 110.0 (GPT-99XX/99XXA)

**Example** MANU1:ACW:CHIS 10.0  
Sets the ACW HI SET current to 10 mA.

Set →

## MANU1:ACW:CLOSet

→ Query

**Description** Sets or returns the ACW LO SET current value in milliamps for the slave unit when in LINK mode. The LO SET value must be less than the HI SET value. The test must first be in ACW mode before this command can be used.

The LO SET range must use the HI SET range. If all the digits in the LO SET range are outside the HI SET range, an error will be produced. All digits outside the HI SET range are ignored and will not be used.

For example:

HI SET value: 12.34

LO SET value1: 0.005 → error

LO SET value2: 0.053 → no error

In the example above LO SET value1 will produce an error as all digits are outside the range of HI SET. LO SET value2 will not produce an error, but will return 0.05, not 0.053.

Syntax	MANU1:ACW:CLOSet<NR2>	
Query Syntax	MANU1:ACW:CLOSet?	
Parameter/ Return parameter	<NR2>	0.000 ~ 041.9 (GPT-98XX) 0.000 ~ 109.9 (GPT-99XX/99XXA)
Example	MANU1:ACW:CLOS 20.0 Sets the ACW LO SET current to 20 mA for the slave unit.	

Set →

← Query

### MANU1:ACW:TTIME

**Description** Sets or returns the ACW test time in seconds for the slave unit when in LINK mode. The test must first be in ACW mode before this command can be used.

Note: A "TIME ERR" will result if the Ramp Time + Test Time is  $\geq 240$  seconds when the HI SET limit is over 30mA (GPT-98XX) or over 80mA (GPT-99XX/99XXA). This applies to the ACW function only.

In special MANU mode, the TIMER can be turned off.

Syntax	MANU1:ACW:TTIME {<NR2> OFF}	
Query Syntax	MANU1:ACW:TTIME?	
Parameter	<NR2>	0.5 ~ 999.9 seconds
	OFF	TIMER OFF (special MANU mode).
Return parameter	<NR2>	0.5 ~ 999.9 seconds
	TIME OFF	TIMER is OFF (special MANU mode).

**Example** MANU1:ACW:TTIM 1  
Sets the ACW test time to 1 second for the slave unit.

**MANU1:ACW:FREQuency**

Set →

→ Query

Description	Sets or returns the ACW test frequency in Hz for the slave unit when in LINK mode. The test must first be in ACW mode before this command can be used.
Syntax	MANU1:ACW:FREQuency {50 60}
Query Syntax	MANU1:ACW:FREQuency?
Parameter/ Return parameter	50      50 Hz 60      60 Hz
Example	MANU1:ACW:FREQ 50  Sets the ACW test frequency to 50Hz for the slave unit.

Set →

→ Query

**MANU1:ACW:REF**

Description	Sets or returns the ACW reference value in mA for the slave unit. The test must first be in ACW mode before this command can be used.  The ACW reference value must be less than the HI SET value.  The ACW reference value must use the same range as the HI SET value.
Syntax	MANU1:ACW:REF <NR2>
Query Syntax	MANU1:ACW:REF?
Parameter/ Return parameter	<NR2>    0.000 ~ 041.9 (GPT-98XX) 0.000 ~ 109.9 (GPT-99XX/99XXA)
Example	MANU1:ACW:REF 0.01  Sets the ACW reference to 0.01 mA for the slave unit.

**MANU1:ACW:ARCCurrent**

Set →

→ Query

**Description** Sets or returns the ACW ARC current value in mA for the slave unit when in LINK mode. ARC must be enabled before the ARC current can be set. The test must first be in ACW mode before this command can be used.

ARC current uses the same range as the HI SET value. The ARC current is limited to 2X the HI SET value.

**Syntax** MANU1:ACW:ARCCurrent <NR2>

**Query Syntax** MANU1:ACW:ARCCurrent?

**Parameter/** <NR2> 1.000 ~ 080.0 (GPT-98XX)

**Return parameter** 2.000 ~ 200.0 (GPT-99XX/99XXA)

**Example** MANU1:ACW:ARCC 0.04

Sets the ACW ARC value to 0.04 mA for the slave unit.

Set →

→ Query

**MANU1:DCW:VOLTage**

**Description** Sets or returns the DCW voltage in kV for the slave unit. The test must first be in DCW mode before this command can be used.

Note: A “DC Over 50W” error will result if the DCW Voltage X HI SET value is > 50 watts (GPT-98XX).

Note: A “DC Over 100W” error will result if the DCW Voltage X HI SET value is > 100 watts (GPT-99XX/99XXA).

**Syntax** MANU1:DCW:VOLTage <NR2>

**Query Syntax** MANU1:DCW:VOLTage?

**Parameter/** <NR2> 0.100 ~ 6.100 (kV)

**Return parameter**

**Example** MANU1:DCW:VOLT 6

Sets the DCW voltage to 6 kV for the slave unit.

**MANU1:DCW:CHISet**

Set →

→ Query

**Description** Sets or returns the DCW HI SET current value in milliamps for the slave unit when in LINK mode. The test must first be in DCW mode before this command can be used.

Note: A “DC Over 50W” error will result if the DCW Voltage X HI SET value is > 50 watts.

Note: A “DC Over 100W” error will result if the DCW Voltage X HI SET value is > 100 watts (GPT-99XX/99XXA)

**Syntax** MANU1:DCW:CHISet <NR2>

**Query Syntax** MANU1:DCW:CHISet?

**Parameter/** <NR2> 0.001 ~ 011.0 (GPT-98XX)

**Return parameter** 0.001 ~ 021.0 (GPT-99XX/99XXA)

**Example** MANU1:DCW:CHIS 5

Sets the DCW HI SET current to 5mA.

Set →

**MANU1:DCW:CLOSet**

→ Query

**Description** Sets or returns the DCW LO SET current value in milliamps for the slave unit when in LINK mode. The LO SET value must be less than the HI SET value. The test must first be in DCW mode before this command can be used.

The LO SET range must use the HI SET range. If all the digits in the LO SET range are outside the HI SET range, an error will be produced. All digits outside the HI SET range are ignored and will not be used.

For example:

HI SET value: 12.34

LO SET value1: 0.005 → error

LO SET value2: 0.053 → no error

In the example above LO SET value1 will produce an error as all digits are outside the range of HI SET. LO SET value2 will not produce an error, but will return 0.05, not 0.053.

Syntax	MANU1:DCW:CLOSet<NR2>	
Query Syntax	MANU1:DCW:CLOSet?	
Parameter/	<NR2>	0.000 ~ 010.9 (GPT-98XX)
Return parameter		0.000 ~ 020.9 (GPT-99XX/99XXA)
Example	MANU1:DCW:CLOS 2.00	
	Sets the DCW LO SET current to 2mA for the slave unit.	

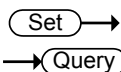

**MANU1:DCW:TTIME**

**Description** Sets or returns the DCW test time in seconds for the slave unit when in LINK mode. The test must first be in DCW mode before this command can be used.

In special MANU mode, the TIMER can be turned off.

Syntax	MANU1:DCW:TTIME {<NR2> OFF}	
Query Syntax	MANU1:DCW:TTIME?	
Parameter	<NR2>	0.5 ~ 999.9 seconds
	OFF	TIMER OFF (special MANU mode).
Return parameter	<NR2>	0.5 ~ 999.9 seconds
	TIME OFF	TIMER is OFF (special MANU mode).

Example            MANU1:DCW:TTIM 1  
                          Sets the DCW test time to 1 second for the slave unit.

**MANU1:DCW:REF**

Set →

→ Query

Description       Sets or returns the DCW reference value in mA for the slave unit when in LINK mode. The test must first be in DCW mode before this command can be used.

The reference value must be less than the HI SET value.

The reference value uses the same range as the HI SET value.

Syntax            MANU1:DCW:REF <NR2>

Query Syntax     MANU1:DCW:REF?

Parameter/	<NR2>	0.000 ~ 010.9 (GPT-98XX)
Return parameter		0.000 ~ 020.9 (GPT-99XX/99XXA)

Example            MANU1:DCW:REF 0.01  
                          Sets the DCW reference to 0.01 mA for the slave unit.

Set →

→ Query

Description       Sets or returns the DCW ARC current value in mA for the slave unit when in LINK mode. ARC must be enabled to set the ARC current. The test must first be in DCW mode before this command can be used.

ARC current uses the same range as the HI SET value. The ARC current is limited to 2X the HI SET value.

Syntax            MANU1:DCW:ARCCurrent <NR2>

Query Syntax     MANU1:DCW:ARCCurrent?

Parameter/	<NR2>	1.000 ~ 20.00 (GPT-98XX)
Return parameter		2.000 ~ 040.0 (GPT-99XX/99XXA)

Example                    MANU1:DCW:ARCC 10  
                                  Sets the DCW ARC value to 10mA for the slave unit.

Set →

**MANU1:IR:VOLTage**

→ Query

Description              Sets or returns the IR voltage in kV for the slave unit when in LINK mode. The test must first be in IR mode before this command can be used.

Syntax                    MANU1:IR:VOLTage <NR2>

Query Syntax            MANU1:IR:VOLTage?

Parameter/  
Return parameter      <NR2>    0.05 ~ 1 (0.05kV to 1kV: steps of .05)  
                                  \*GPT-99XX/99XXA also includes a  
                                  0.125kV point.

Example                    MANU1:IR:VOLT 1  
                                  Sets the IR voltage to 1 kV for the slave unit.

Set →

**MANU1:IR:RHISet**

→ Query

Description              Sets or returns the IR HI SET resistance value in MΩ (GPT-98XX) or GΩ for the slave unit when in LINK mode. The test must first be in IR mode before this command can be used.

Syntax                    MANU1:IR:RHISet <NR1>|NULL

Query Syntax            MANU1:IR:RHISet?

Parameter/  
Return parameter      <NR1>    GPT-98XX only:  
                                  2 ~ 9999 (unit = MΩ)  
                                  GPT-99XX/GPT-99XXA only:  
                                  Format A: 0.002 ~ 50.00 (unit = GΩ)  
                                  Format B: 0.002G ~ 50.00G  
                                  Format C: 2M ~ 50000M

NULL                    Sets the HI SET value to ∞.

Example                    MANU1:IR:RHIS 10  
 (GPT-98XX)              Sets the IR HI SET resistance to 10 MΩ for the slave unit.



Example                    MANU1:IR:TTIM 1  
                                  Sets the IR test time to 1 second for the slave unit.

Set →

**MANU1:IR:REF**

→ Query

Description                Sets or returns the IR reference value in MΩ (GPT-98XX) or GΩ for the slave unit when in LINK mode. The test must first be in IR mode before this command can be used.  
  
                                  The reference value must be lower than the HI SET value.

Syntax                      MANU1:IR:REF <NR1>

Query Syntax                MANU1:IR:REF?

Parameter/ Return parameter	<b>&lt;NR1&gt;</b>	GPT-98XX only: 0000 ~ 9999 (unit = MΩ) GPT-99XX/GPT-99XXA only: Format A: 0 ~ 50.00 (unit = GΩ) Format B: 0G ~ 50.00G Format C: 0M ~ 50000M
--------------------------------	--------------------	--

Example                      MANU1:IR:REF 900  
 (GPT-98XX)                    Sets the IR reference to 900 MΩ for the slave unit.

Example                      MANU1:IR:REF 0.900  
 (GPT-99XX/  
 99XXA)                        Sets the IR reference to 900 MΩ for the slave unit.

Set →

**MANU:GB:CUTMode**

→ Query

Description                Sets or returns the cutoff mode as resistance or voltage. The cutoff mode determines whether pass or fail testing is judged on resistance or voltage limits. This is equivalent to the front panel operation of using the PAGE key to select the HI/LO units when in EDIT status (page 40).

Syntax                      MANU:GB:CUTMode { CUT\_R | CUT\_V }

Query Syntax                MANU:GB:CUTMode?

Parameter/	CUT_R	Cutoff mode is set to resistance.
Return parameter	CUT_V	Cutoff mode is set to voltage.

Example1      MANU:GB:CUTMode CUT\_R  
 Sets the cutoff mode to resistance.

Example2      MANU:GB:CUTMode?  
 >CUT\_R  
 The cutoff mode is set as resistance cutoff.

Set →

→ Query

**MANU:GB:CURREnt**

Description      Sets or returns the GB current in A. The test must first be in GB mode before this command can be used.

Syntax            MANU:GB:CURREnt <NR2>

Query Syntax     MANU:GB:CURREnt?

Parameter/	<NR2>	3.00~40.00
Return parameter		

Example            MANU:GB:CURR 3.00  
 Sets the GB current to 3.00A.

Set →

→ Query

**MANU:GB:RHISet**

Description      Sets or returns the GB HI SET resistance value in mΩ. The test must first be in GB mode and the cutoff mode must be set to CUT\_R (see the MANU:GB:CUTMode command) before this command can be used.

Syntax            MANU:GB:RHISet <NR2>

Query Syntax     MANU:GB:RHISet?

Parameter/	<NR2>	000.1 ~ 650.0
Return parameter		

Example            MANU:GB:RHIS 100.0  
 Sets the HI SET value to 100mΩ.



Note

If the (GB current x HI SET resistance) > 7.2V, then an error will be generated (“GB Over”).

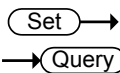

**MANU:GB:RLOSet**

**Description** Sets or returns the GB LO SET resistance value in mΩ. The LO SET value must be less than the HI SET value. The test must first be in GB mode and the cutoff mode must be set to CUT\_R (see the MANU:GB:CUTMode command) before this command can be used.

**Syntax** MANU:GB:RLOSet<NR2>

**Query Syntax** MANU:IR:RLOSet?

**Parameter/ Return parameter** <NR2> 0.000 ~ 649.9

**Example** MANU:GB:RLOS 50  
Sets the GB LO SET resistance to 50mΩ.

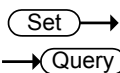

**MANU:GB:VHISet**

**Description** Sets or returns the GB HI SET voltage value in V. The test must first be in GB mode and the cutoff mode must be set to CUT\_V (see the MANU:GB:CUTMode command) before this command can be used.

**Syntax** MANU:GB:VHISet <NR2>

**Query Syntax** MANU:GB:VHISet?

**Parameter/ Return parameter** <NR2> 0.001 ~ 7.200

**Example** MANU:GB:VHIS 2.000  
Sets the HI SET voltage to 2V.



Note

REF# (V) + HI Set (V) < 7.2V.

## MANU:GB:VLOSet

Set →

→ Query

**Description** Sets or returns the GB LO SET voltage value in V. The LO SET value must be less than the HI SET value. The test must first be in GB mode and the cutoff mode must be set to CUT\_V (see the MANU:GB:CUTMode command) before this command can be used.

**Syntax** MANU:GB:VLOSet<NR2>

**Query Syntax** MANU:GB:VLOSet?

**Parameter/  
Return parameter** <NR2> 0.000V ~ 7.199V

**Example** MANU:GB:VLOS 1.000  
Sets the GB LO SET voltage to 1V.

Set →

→ Query

## MANU:GB:TTIME

**Description** Sets or returns the GB test time in seconds. The test must first be in GB mode before this command can be used.

**Syntax** MANU:GB:TTIME <NR2>

**Query Syntax** MANU:GB:TTIME?

**Parameter/  
Return parameter** <NR2> 0.5 ~ 999.9 seconds

**Example** MANU:GB:TTIM 1  
Sets the GB test time to 1 second.

**MANU:GB:FREQuency**

Set →

→ Query

Description	Sets or returns the GB test frequency in Hz. The test must first be in GB mode before this command can be used.	
Syntax	MANU:GB:FREQuency {50 60}	
Query Syntax	MANU:GB:FREQuency?	
Parameter/	50	50 Hz
Return parameter	60	60 Hz
Example	MANU:GB:FREQ 50 Sets the GB test frequency to 50Hz.	

**MANU:GB:REF**

Set →

→ Query

Description	Sets or returns the GB reference value in mΩ. The test must first be in GB mode before this command can be used.	
	The GB reference value must be less than the HI SET value.	
Syntax	MANU:GB:REF <NR2>	
Query Syntax	MANU:GB:REF?	
Parameter/	<NR2>	0.000 ~ 649.9
Return parameter		
Example	MANU:GB:REF 100 Sets the GB reference to 100 mΩ.	

**MANU:GB:ZEROCHECK**

Set →

→ Query

**Description** Performs the zero check function. The test must first be in GB mode and in the Ready Status before this command can be used.

See page 54 for details on the ZERO function.

**Syntax** MANU:GB:ZEROCHECK {ON|OFF}

**Query Syntax** MANU:GB:ZEROCHECK?

**Parameter/** ON Zero function is active.

**Return parameter** OFF Zero function is not active.

**Example** MANU:GB:ZEROCHECK OFF

Activates the ZERO function.

Set →

→ Query

**MANU1:UTILity:ARCMoDe**

**Description** Sets or returns the ARC mode status for the current test of the slave unit when in LINK mode. The ARC mode cannot be set for the IR and GB function.

**Syntax** MANU1:UTILity:ARCMoDe {OFF|ON\_CONT|ON\_STOP}

**Query Syntax** MANU1:UTILity:ARCMoDe?

**Parameter/** OFF Turns ARC mode off.

**Return parameter** ON\_CONT Sets ARC mode to ON and CONTINUE.

ON\_STOP Sets ARC mode to ON and STOP.

**Example** MANU1:UTIL:ARCM OFF

Turns ARC mode OFF for the slave unit.

**MANU1:UTILity:PASShold**

Set →

→ Query

Description	Sets or returns the PASS HOLD setting for the current test of the slave unit when in LINK mode.	
Syntax	MANU1:UTILity:PASShold {ON OFF}	
Query Syntax	MANU1:UTILity:PASShold?	
Parameter/	OFF	Turns PASS HOLD off.
Return parameter	ON	Turns PASS HOLD on.
Example	MANU1:UTIL:PASS OFF Turns PASS HOLD OFF for the slave unit.	

Set →

→ Query

**MANU1:UTILity:FAILmode**

Description	Sets or returns the FAIL mode setting for the current test for the slave unit when in LINK mode.	
Syntax	MANU1:UTILity:FAILmode {CONT HOLD STOP}	
Query Syntax	MANU1:UTILity:FAILmode?	
Parameter/	CONT	Sets/returns the fail mode as continue.
Return parameter	HOLD	Sets/returns the fail mode as hold.
	STOP	Sets/returns the fail mode as stop.
Example	MANU1:UTIL:FAIL CONT Sets the fail mode to CONT (continue) for the slave unit.	

Set →

→ Query

**MANU1:UTILity:MAXHold**

Description	Sets or returns the MAX HOLD setting for the current test for the slave unit when in LINK mode.	
Syntax	MANU1:UTILity:MAXHold {ON OFF}	
Query Syntax	MANU1:UTILity:MAXHold?	
Parameter/	OFF	Turns MAX HOLD off.
Return parameter	ON	Turns MAX HOLD on.

Example            MANU1:UTIL:MAXH ON  
                          Turns MAX HOLD on for the slave unit.

MANU1:UTILity:GROUNDMODE (Set) →  
→ (Query)

Description       Sets or returns the Grounding mode of the current test for the slave unit when in LINK mode.  
                          The Ground Mode setting cannot be turned on with the IR and GB function.

Syntax             MANU1:UTILity:GROUNDMODE {ON|OFF}

Query Syntax     MANU1:UTILity:GROUNDMODE?

Parameter/       OFF             Turns ground mode off.

Return parameter ON             Turns ground mode on.

Example            MANU1:UTIL:GROUNDMODE ON  
                          Turns GROUND MODE on for the slave unit.

MANU<x>:EDIT:SHOW → (Query)

Description       Returns the test parameters of a selected manual test for the GCT-9040.

Query Syntax     MANU<x>:EDIT:SHOW?

Parameter/       <x>             <NR1> 000~100. Manual test number

Return parameter <string>       Returns a string in the following format:  
                          Test function, test voltage, HI SET value, LO SET value, Ramp time, test time.

Example            MANU1:EDIT:SHOW?  
                          >GB ,09.14A ,H=598.8m ,L=000.0m ,V=5.473v,  
                          T=000.5S  
                          Returns the test parameters of manual test number 1.

**TESTok:RETurn**

Set →

→ Query

**Description**      Allows "OK" to be displayed on the remote terminal when a test has stopped (PASS/FAIL or STOP). When used with a slave, "OK" is displayed after all tested have stopped.

By default, TESTok:RETurn is set to OFF.

**Syntax**              TESTok:RETurn {ON|OFF}

**Query Syntax**      TESTok:RETurn?

**Parameter/Return parameter**      ON      Enables the "OK" message to be displayed.

OFF      Disables the message

**Example**              TEST:RET OFF  
 Disables the message.

## Common Commands

*CLS.....	125
*IDN .....	125
*IDN1 .....	125

\*CLS (Set) →

Description      The \*CLS command clears the internal registers.

Syntax            \*CLS

\*IDN → (Query)

Description      Queries the model number, serial number, and firmware version of the tester.

Query Syntax     \*IDN?

Return parameter <string> Returns the instrument identification as a string in the following format:

GCT-9040,XXXXXXXXXXXX,V1.00

Model number : GCT-9040

Serial number :12 character serial number

Firmware version : V1.00

\*IDN1 → (Query)

Description      Queries the model number, serial number, and firmware version of the slave unit when in LINK mode.

Query Syntax     \*IDN1?

Return parameter <string> Returns the instrument identification as a string in the following format:

GPT-9803,XXXXXXXXXXXX,V1.00

Model number : GPT-9803

Serial number :12 character serial number

Firmware version : V1.00

## Remote Commands

\*RMTOFF .....127

### \*RMTOFF



**Description**      This command can be used to terminate a remote session. When this command is used "RMT" will no longer be displayed on the front panel, indicating that remote mode has been terminated.

**Syntax**            \*RMTOFF

## Special Functions

InterLock Key Open .....127

### InterLock Key Open



**Description**      This special function is not a command. When in remote mode, the GCT-9040 will send the message, "InterLock Key Open" if a test is started with INTERLOCK set to ON, but the interlock signal I/O pins are not shorted (either with the included interlock key or manually).

This special function is analogous to the "INTERLOCK OPEN" message that is displayed on the front panel under the same conditions (page 72).

## Error Messages

---

Background            The possible error messages returned from SYST:ERR? or SYST1:ERR queries are listed below.

---

Error	Error Code
Command Error	0x14
Value Setting Error	0x15
String Setting Error	0x16
Query Error	0x17
MODE Setting Error	0x18
Time Error	0x19
DC Over 50W (GPT-98XX only)	0x1A
DC Over 100W (GPT-99XX/99XXA only)	0x1A
GBV Over	0x1B

---

# F FAQ

---

- The tester will not turn on.
- The panel keys are not working.
- When I press the START button the tester will not start testing?
- The accuracy does not match the specification.

## The tester will not turn on.

---

Ensure the power cord is connected. Ensure the line input is set to the correct line voltage. Check to make sure the fuse is not blown. See page 131.

## The panel keys are not working.

---

Ensure the tester is not in remote mode, page 84.

Ensure the tester is not in SIGNAL I/O or Remote Connect mode, page 70.

## When I press the START button the tester will not start testing?

---

The tester must first be in the READY status before a test can be started. Ensure the tester displays READY before pressing the START button, page 47 (manual test).

If “Double Action” is enabled, the START button must be pressed 0.5 seconds after the STOP button is pressed, otherwise the tester will not start testing.

If “Interlock” is enabled, the interlock key must be inserted into the signal I/O port on the rear before a test can be started. See page 80 for details.

Lastly, ensure that the Start Ctrl setting is correctly configured in the Common Utility menu. For example, to enable the START button to start a test, ensure that the Start Ctrl setting is set to FRONT PANEL. See page 70 for details.

The accuracy does not match the specification.

---

Make sure the tester is powered on for at least 30 minutes, within +15°C~+35°C. This is necessary to stabilize the unit to match the specification.

For more information, contact your local dealer or GWInstek at [www.gwinstek.com](http://www.gwinstek.com) / [marketing@goodwill.com.tw](mailto:marketing@goodwill.com.tw).

# APPENDIX

## Fuse Replacement

---

### Steps

1. Turn the instrument off.

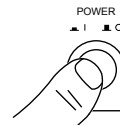

2. Remove the power cord.

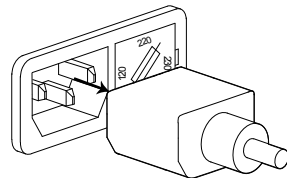

3. Remove the fuse socket using a flat screwdriver.

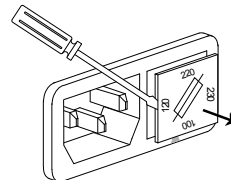

4. Replace the fuse in the fuse holder.

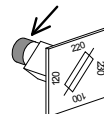

5. Ensure the correct line voltage is lined up with the arrow on the fuse holder. Insert the fuse socket.

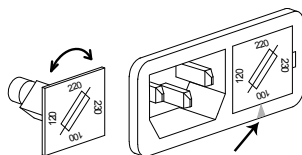

Rating	The fuse for the GCT-9040:	
	100V/120V	T7A 250V
	220V/230V	T4A 250V

## Error Messages

### System Self Test

The following error messages or messages may appear on the GCT-9040 screen during the Start-Up initialization. If any of these error messages appear on the unit, please see an authorized GW Instek distributor.

Error Messages	Description
0x11	EEPROM1 Error
0x12	EEPROM1 Error
0x24	GB-I Offset Error

## Test Errors

The following error messages or messages may appear on the GCT screen when configuring or running tests.

Error Messages	Description
SHORT	Voltage is too low or there is no High Voltage output. Indicates that the DUT could be shorted.
V = 0	For GB tests. Voltage is equal to 0. Check to see that the SENSE H or SOURCE H is not open.
I<SET	For GB tests. Current too low. Indicates that the SOURCE L or SOURCE H test lead is open or poorly connected. Test the test lead connection with the DUT to confirm.
I>SET	For GB tests. Current is too high.
R=0	For GB tests. Resistance = 0. This error indicates that there is an error with the measured resistance ( $0\Omega$ ). Perform the zeroing function again.
GBV OVER	GBV > 7.2V

# GCT-9040 Specifications

The specifications apply when the GCT-9040 is powered on for at least 30 minutes at 15°C~35°C.

## Specifications

### Environment

Range	Temperature	Humidity
Warranty	15°C ~ 35°C	≤70% (No condensation)
Operation	0°C ~ 40°C	≤70% (No condensation)
Storage	-10°C ~ 70°C	≤85% (No condensation)
Installation Location	Indoors at an amplitude of up to 2000m.	

### Ground Bond Test

Output Current Range	03.00A~40.00A ac
Output Current Accuracy	± (1% of setting +0.2A) when 3A≤I≤8A ± (1% of setting +0.05A) when 8A<I≤40A
Output Current Resolution	0.01A
Test Voltage	Max. 8V ac (open-circuit)
Frequency	50Hz/60Hz selectable
Ohmmeter Measurement Range	1mΩ~650.0mΩ

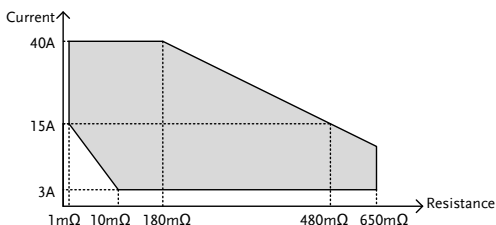

Ohmmeter Measurement Resolution	0.1mΩ
Ohmmeter Measurement Accuracy	± (1% of reading +2mΩ)
Ohmmeter Judgment Accuracy	± (1% of setting +2mΩ)
Voltmeter Measurement Resolution	0.001V

Voltmeter Measurement Accuracy	$\pm$ (1% of reading +0.02V)
Voltmeter Judgment Accuracy	$\pm$ (2% of setting +0.05V)
Window Comparator Method	Yes
TIMER (Test Time)	0.5s~999.9s
Test Method	Four Terminal

**Interface**

Link	Standard
USB (Device)	Standard
GPIB	Option
Remote Terminal (Front)	Standard
Signal I/O	Standard
Display	240 x 64 Ice Blue Dot matrix LCD
Power Source	AC100V/120V/220V/230V $\pm$ 10%, 50/60Hz Power Consumption: Max 700VA
Dimensions & Weight	330(W) x 148(H) x 460(D) mm (Max.) Approximately 17kg max
Memory	Single Step Memory (MANU: 100 blocks)

**Table 1: Output Limitation in GCT-9040**

	Upper Current	Pause	Output Time
GB	$20A < I \leq 40A$	At least as long as the output time	999.9
	$3A \leq I \leq 20A$	Not necessary	999.9

NOTE: Output Time = Ramp Time + Test Time.

## GCT-9040 Dimensions

---

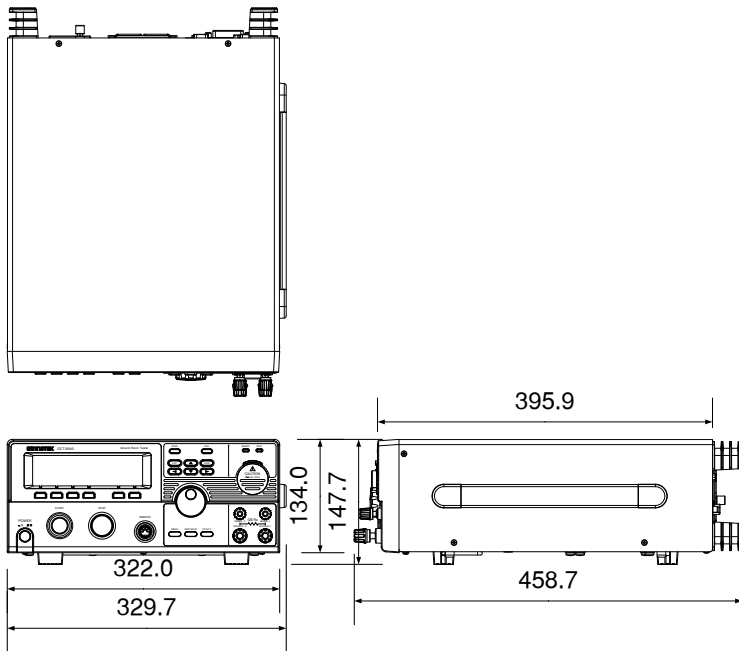

## Declaration of Conformity

We **Good Will Instrument Co., Ltd.** declares under our own responsibility that the product **AC/DC/IR/GB Electrical Safety Tester (Model No.: GCT-9040)** satisfies all the technical relations application to the product within the scope of council:

**Directive: 2014/30/EU; 2014/35/EU; 2015/863/EU; 2012/19/EU**

The above product is in conformity with the following standards or other normative documents

<b>Harmonized Standard :</b>
EN 61010-1:2010
EN 61010-2-030:2010
EN 61326-1:2013
EN 61326-2-1:2013

<b>Reference Basic Standards :</b>	
<b>Emission:</b>	<b>Immunity:</b>
EN 55011: 2009+A1: 2010 Class A	EN 61000-4-2: 2009
EN 61000-3-2: 2014	EN 61000-4-3: 2006+A1: 2008+A2: 2010
EN 61000-3-3: 2013	EN 61000-4-4: 2012
	EN 61000-4-5: 2006
	EN 61000-4-6: 2014
	EN 61000-4-8: 2010
	EN 61000-4-11: 2004

# I NDEX

Accessories .....	11	Manual tests	
Caution symbol .....	5	GB .....	36
Cleaning the instrument .....	7	ground mode .....	33
Dimensions .....	134	results .....	51
Disposal instructions .....	7	running a test .....	47
EN61010		saving .....	45
measurement category .....	6	test filename .....	44
pollution degree .....	7	test frequency .....	39
Environment		test limits .....	40
safety instruction .....	7	test reference .....	42
Error messages .....	126	test selection .....	37
External control .....	73	test settings .....	38
Interlock key .....	79	test time .....	43
overview .....	74	test voltage .....	39
remote operation .....	75	Marketing	
remote terminal .....	74	contact .....	128
signal I/O operation .....	78	Menu tree .....	26
signal I/O overview .....	76	Operating precautions .....	23
FAQ .....	127	Overview .....	10
Front panel diagram .....	14	Package contents .....	13
Fuse replacement .....	129	Power on/off	
GB		safety instruction .....	6
test connection .....	30	Rear panel diagram .....	17
GB testing .....	36	Remote control .....	80
GPIB installation .....	21	Command list	
Ground		GCT-9040 .....	88
symbol .....	5	Command syntax .....	85
Ground mode .....	33	function check .....	82
Interlock key .....	79	interface configuration .....	81
Line voltage selection .....	19	Self test error messages .....	130
Link		Service operation	
test connection .....	30	about disassembly .....	6
Link tests		contact .....	128
configuration .....	59	Specifications .....	132
connection .....	58	Test errors .....	131
overview .....	57	Test lead connection .....	30
running link test .....	62	UK power cord .....	8
List of features .....	11	Utility settings	

buzzer .....	66	Signal I/O Time .....	71
Control settings.....	69	start control.....	69
double action.....	69	USB .....	67
GPIB .....	67	Warning symbol.....	5
interface .....	67	Workplace precautions .....	22
key lock.....	69	Zeroing .....	54
LCD .....	65		