

Digital Storage Oscilloscope

GDS-2000HD/HG series

PROGRAMMING MANUAL



ISO-9001 CERTIFIED MANUFACTURER

GW INSTEK

This manual contains proprietary information which is protected by copyright. All rights are reserved. No part of this manual may be photocopied, reproduced or translated to another language without prior written consent of Good Will Corporation.

The information in this manual was correct at the time of printing. However, Good Will continues to improve products and reserves the right to change specifications, equipment, and maintenance procedures at any time without notice.

Windows is a registered trademark of Microsoft Corporation in the United States and other countries.

Good Will Instrument Co., Ltd.
No. 7-1, Jhongsing Rd., Tucheng Dist., New Taipei City 236, Taiwan.

Table of Contents

COMMAND OVERVIEW	4
Command Syntax	4
List of Commands in Functional Order	6
COMMAND DETAILS	17
Common Commands	18
Mask Commands	22
Acquisition Commands.....	26
Autoscale Commands	34
Vertical Commands.....	35
Math Commands	40
Cursor Commands	49
Display Commands.....	63
Measure Commands	67
Measurement Commands	90
Reference Commands	100
Run Command	102
Stop Command	102
Force Command.....	102
Timebase Commands.....	103
Trigger Commands.....	106
System Commands	132
Save/Recall Commands	133
Bus Decode Commands	137
Label Commands	154
DVM Commands.....	159
AWG Commands.....	164
FRA Commands	175

C **COMMAND OVERVIEW**

The Command overview chapter lists all GDS-2000HD/HG commands in functional order as well as alphabetical order. The command syntax section shows you the basic syntax rules you have to apply when using commands.

Command Syntax

- | | |
|---------------------|---|
| Compatible standard | <ul style="list-style-type: none"> • USB CDC_ACM compatible • SCPI, 1994 (partially compatible) |
|---------------------|---|

Command forms Commands and queries have two different forms, long and short. The command syntax is written with the short form of the command in capitals and the remainder (long form) in lower case.

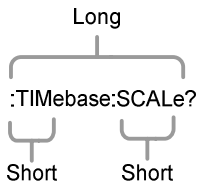

The commands can be written in capitals or lower-case, just so long as the short or long forms are complete. An incomplete command will not be recognized.

Below are examples of correctly written commands.

LONG :TIMEbase:SCALE? :TIMEBASE:SCALE?
:timebase:scale?

SHORT :TIM:SCAL? :TIM:SCAL?

Command format :TIMEbase:SCALE <NR3>LF 1: command header

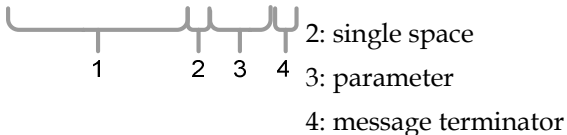

Parameter	Type	Description	Example
	<Boolean>	boolean logic	0, 1
	<NR1>	Integers	0, 1, 2, 3
	<NR2>	floating point	0.1, 3.14, 8.5
	<NR3>	floating point with an exponent	4.5e-1, 8.25e+1
	<NRf>	any of NR1, 2, 3	1, 1.5, 4.5e-1
Message terminator	LF	line feed code	



Note

Commands are non-case sensitive.

List of Commands in Functional Order

Common commands	*IDN?	18
	*RST	18
	*CLS	18
	*ESE	18
	*ESR	19
	*OPC	20
	*SRE	20
*STB	21	
<hr/>		
Mask commands	:MASK:STATe	22
	:MASK:SOURce	22
	:MASK:VIOLation	22
	:MASK:VIOLation:MODE	23
	:MASK:VIOLation:BEEP	23
	:MASK:SAVe (0 - 7)	23
	:MASK:RECALL (0 - 7)	24
	:MASK:RESults:FAILed	24
	:MASK:RESults:PASSed	24
	:MASK:RESults:TOTal	25
:MASK:AUTo	25	
:MASK:RESults:DISPlay	25	
<hr/>		
Acquisition commands	:ACQuire:AVERage	26
	:ACQuire:MODE	26
	:ACQuire<X>:MEMory?	27
	:ACQuire:FILTer:SOURce	29
	:ACQuire:FILTer	29
	:ACQuire:FILTer:FREQuency:UPPER	30
	:ACQuire:FILTer:FREQuency:LOWER	30
	:ACQuire:FILTer:TYPe	31
	:ACQuire:FILTer:WINDow	31
	:ACQuire:FILTer:VERTical:POSition	31
:ACQuire<X>:STATe?	32	

	:ACQuire:INTERpolation	32
	:ACQuire:RECOrdlength.....	33
	:ACQuire:SAMPLerate?.....	33
<hr/>		
Autoscale commands	:AUTOSet	34
<hr/>		
Vertical Scale commands	:CHANnel<X>:BWLimit.....	35
	:CHANnel<X>:COUPling.....	35
	:CHANnel<X>:DISPlay	36
	:CHANnel<X>:EXPand	36
	:CHANnel<X>:IMPedance.....	37
	:CHANnel<X>:INVert	37
	:CHANnel<X>:POSition	38
	:CHANnel<X>:PROBe:RATio	38
	:CHANnel<X>:PROBe:TYPe.....	39
	:CHANnel<X>:SCALE	39
<hr/>		
Math commands	:MATH:DISP	40
	:MATH:TYPe	40
	:MATH:DUAL:SOURce<X>	40
	:MATH:DUAL:OPERator	41
	:MATH:DUAL:POSition.....	41
	:MATH:DUAL:SCALE.....	42
	:MATH:FFT:SOURce	42
	:MATH:FFT:MAG.....	42
	:MATH:FFT:WINDow	43
	:MATH:FFT:POSition	43
	:MATH:FFT:SCALE.....	44
	:MATH:FFT:HORIZontal:SCALE.....	44
	:MATH:FFT:HORIZontal:POSition.....	44
	:MATH:FFT:PEAKSTable:DISPlay	45
	:MATH:FFT:PEAKSTable: NUM	45
	:MATH:FFT:PEAKSTable:THReshol	45
	:MATH:FFT:PEAKSTable:ORDer.....	46
	:MATH:DEFine	46
	:MATH:LABel.....	47

	:MATH:LABel:DISPlay	47
	:MATH:ADVanced:POSition	48
	:MATH:ADVanced:SCALE	48
<hr/>		
Cursor	:CURSor:MODE	49
commands	:CURSor:SOURce.....	49
	:CURSor:HUNI	50
	:CURSor:HUSE	51
	:CURSor:VUNI	51
	:CURSor:VUSE	51
	:CURSor:H1Position	52
	:CURSor:H2Position	52
	:CURSor:HDELta	53
	:CURSor:V1Position.....	54
	:CURSor:AREA	54
	:CURSor:V2Position.....	55
	:CURSor:VDELta	55
	:CURSor:TIME:TYPe	55
	:CURSor:XY:RECTangular:X:UNIts	56
	:CURSor:XY:RECTangular:X:POSition<X>	56
	:CURSor:XY:RECTangular:X:DELta	56
	:CURSor:XY:RECTangular:Y:UNIts	57
	:CURSor:XY:RECTangular:Y:POSition<X>	57
	:CURSor:XY:RECTangular:Y:DELta	57
	:CURSor:XY:POLar:RADIUS:UNIts	58
	:CURSor:XY:POLar:RADIUS:POSition<X>	58
	:CURSor:XY:POLar:RADIUS:DELta	58
	:CURSor:XY:POLar:THETA:UNIts.....	59
	:CURSor:XY:POLar:THETA:POSition<X>	59
	:CURSor:XY:POLar:THETA:DELta.....	59
	:CURSor:XY:PRODUct:UNIts	60
	:CURSor:XY:PRODUct:POSition<X>	60
	:CURSor:XY:PRODUct:DELta	60
	:CURSor:XY:PRODUct:UNIts	61
	:CURSor:XY:RATio:POSition<X>.....	61

	:CURSor:XY:RATio:UNIts	61
	:CURSor:HTRACKing	61
	:CURSor:VTRACKing	62
	:CURSor:XY:RATio:DELta	62

Display commands	:DISPlay:INTensity:WAVEform.....	63
	:DISPlay:INTensity:GRATicule.....	63
	:DISPlay:INTensity:BACKLight	63
	:DISPlay:INTENSITy:BACKLight:AUTODim:TIME	64
	:DISPlay:PERsistence	64
	:DISPlay:GRATicule	65
	:DISPlay:WAVEform.....	65
	:DISPlay:TRANSREADouts	65
	:DISPlay:WAVEform:COLor.....	66

Measure commands	:MEASure:GATing.....	67
	:MEASure:SOURce	67
	:MEASure:METHod	67
	:MEASUrement:REFLevel:PERCent:HIGH.....	68
	:MEASUrement:REFLevel:PERCent:LOW	68
	:MEASUrement:REFLevel:PERCent:MID	69
	:MEASure:FALL.....	69
	:MEASure:FREQuency	70
	:MEASure:NWIDth	70
	:MEASure:PDUTy.....	71
	:MEASure:PERiod	71
	:MEASure:PWIDth	72
	:MEASure:RISe.....	72
	:MEASure:ROVShoot.....	73
	:MEASure:RPReshoot	73
	:MEASure:PPULSE.....	74
	:MEASure:NPULSE	74
	:MEASure:PEDGE	75
:MEASure:NEDGE	75	
:MEASure:AMPlitude.....	76	
:MEASure:MEAN	77	

	:MEASure:CMean	77
	:MEASure:HIGH	78
	:MEASure:LOW	78
	:MEASure:MAX	80
	:MEASure:MIN	80
	:MEASure:PK2PK	81
	:MEASure:RMS	81
	:MEASure:CRMS	82
	:MEASure:AREa	82
	:MEASure:CARea	83
	:MEASure:FRRDelay	83
	:MEASure:FRFDelay	84
	:MEASure:FFRDelay	85
	:MEASure:FFFDelay	85
	:MEASure:LRRDelay	86
	:MEASure:LRFDelay	86
	:MEASure:LFRDelay	88
	:MEASure:LFFDelay	88
	:MEASure:PHAsE	89
<hr/>		
Measurement	:MEASUrement:MEAS<X>:SOURCE<X>	90
commands	:MEASUrement:MEAS<X>:DELay	90
	:MEASUrement:MEAS<X>:DELay:DIRection	91
	:MEASUrement:MEAS<X>:DELay:EDGE<x>	91
	:MEASUrement:MEAS<X>:TYPE	92
	:MEASUrement:MEAS<X>:STATE	92
	:MEASUrement:MEAS<X>:VALue	93
	:MEASUrement:MEAS<X>:MAXimum	94
	:MEASUrement:MEAS<X>:MEAN	94
	:MEASUrement:MEAS<X>:MINimum	95
	:MEASUrement:MEAS<X>:STDdev	96
	:MEASUrement:MEAS<X>:UNIts	96
	:MEASUrement:STATIstics:MODE	97
	:MEASUrement:STATIstics:WEIghting	97
	:MEASUrement:INDICators:STAT	97

	:MEASUrement:INDICators:HORZ<x>?	98
	:MEASUrement:INDICators:VERT<x>?	98
	:MEASUrement:INDICators:NUMHORZ?	99
	:MEASUrement:INDICators:NUMVERT?	99
	:MEASUrement:STATIstics	99
Reference commands	:REF<X>:DISPlay	100
	:REF<X>:OFFSet	100
	:REF<x>:SCALE	101
	:REF:STATe	101
Run command	:RUN	102
Stop command	:STOP	102
Force command	:FORCe	102
Timebase commands	:TIMebase:EXPand	103
	:TIMebase:SCALE	103
	:TIMebase:MODE	103
	:TIMebase:WINDow:POSition	104
	:PLAYStop	104
	:TIMebase:WINDow:SCALE	105
Trigger commands	:TRIGger:TYPe	106
	:TRIGger:SOURce	106
	:TRIGger:COUPle	107
	:TRIGger:MODE	107
	:TRIGger:HOLDoff	107
	:TRIGger:LEVel	108
	:TRIGger:HLEVel	108
	:TRIGger:LLEVel	109
	:TRIGger:LOGic:FUNCTion	109
	:TRIGger:LOGic:PATtern:INPut:D<x>	110
	:TRIGger:LOGic:PATtern:DELTatime	110
	:TRIGger:LOGic:PATtern:WHEn	111

:TRIGger:EDGE:SLOP	112
:TRIGger:PULSEWidth:POLarity	112
:TRIGger:RUNT:POLarity	113
:TRIGger:RUNT:WHEn	113
:TRIGger:RUNT:TIME	114
:TRIGger:RISEFall:SLOP	114
:TRIGger:RISEFall:WHEn	114
:TRIGger:RISEFall:TIME	115
:TRIGger:VIDeo:TYPe	115
:TRIGger:VIDeo:FIELD	116
:TRIGger:VIDeo:LINE	116
:TRIGger:PULSe:WHEn	117
:TRIGger:PULSe:TIME	117
:TRIGger:TIMEOut:TIMER	118
:TRIGger:STATe	118
:TRIGger:BUS:B1:I2C:CONDition	119
:TRIGger:BUS:B1:I2C:ADDRes:MODE	120
:TRIGger:BUS:B1:I2C:ADDRes:VALue	120
:TRIGger:BUS:B1:I2C:ADDRes:DIRection	121
:TRIGger:BUS:B1:I2C:DATA:SIZE	121
:TRIGger:BUS:B1:I2C:DATA:VALue	122
:TRIGger:BUS:B1:UART:CONDition	122
:TRIGger:BUS:B1:UART:RX:DATA:SIZE	123
:TRIGger:BUS:B1:UART:RX:DATA:VALue	124
:TRIGger:BUS:B1:UART:TX:DATA:SIZE	124
:TRIGger:BUS:B1:UART:TX:DATA:VALue	125
:TRIGger:BUS:B1:CAN:CONDition	126
:TRIGger:BUS:B1:CAN:FRAMeType	126
:TRIGger:BUS:B1:CAN:IDentifier:MODE	127
:TRIGger:BUS:B1:CAN:DATA:SIZE	127
:TRIGger:BUS:B1:CAN:DATA:VALue	128
:TRIGger:BUS:B1:LIN:CONDition	128
:TRIGger:BUS:B1:LIN:DATA:SIZE	130
:TRIGger:BUS:B1:LIN:DATA:VALue	130
:TRIGger:BUS:B1:SPI:DATA:SIZE	131

System commands	:SYSTem:LOCK	132
	:SYSTem:ERRor.....	132
<hr/>		
Save/Recall commands	:RECALL:SETUp	133
	:SAVe:IMAGe	133
	:SAVe:IMAGe:FILEFormat.....	134
	:SAVe:IMAGe:INKSaver.....	134
	:SAVe:SETUp.....	134
	:SAVe:WAVEform.....	135
	:SAVe:WAVEform:FILEFormat	136
<hr/>		
Bus Decode Commands	:BUS<x>:STATe.....	137
	:BUS<x>:TYPE	137
	:BUS<x>:I2C:ADDRes:RWINClude.....	138
	:BUS<x>:I2C:SCLK:SOURce	138
	:BUS<x>:I2C:SCLK:THReshold.....	139
	:BUS<x>:I2C:SDA:SOURce.....	139
	:BUS<x>:I2C:SDA:THReshold	139
	:BUS<x>:UART:BITRate.....	140
	:BUS<x>:UART:DATABits.....	140
	:BUS<x>:UART:STOPBits	141
	:BUS<x>:UART:BITOrder	141
	:BUS<x>:UART:SOURce	141
	:BUS<x>:UART:THReshold	142
	:BUS<x>:UART:POLARity.....	142
	:BUS<x>:DISPlay:FORMAt	143
	:BUS<x>:CAN:SOURce.....	143
	:BUS<x>:CAN:PROBe.....	143
	:BUS<x>:CAN:SAMPLEpoint.....	144
	:BUS<x>:CAN:BITRate.....	144
	:BUS<x>:LIN:BITRate	145
	:BUS<x>:LIN:POLARity.....	145
	:BUS<x>:LIN:SOURce	146
	:BUS<x>:LIN:STANDard	146
	:BUS<x>:LIN:THReshold.....	146

:BUS<x>:SPI:FRAMING	147
:BUS<x>:SPI:IDLETime	148
:BUS<x>:SPI:SCLK:POLARity	148
:BUS<x>:SPI:SCLK:SOURce	148
:BUS<x>:SPI:SCLK:THReshold	149
:BUS<x>:SPI:SS:POLARity.....	149
:BUS<x>:SPI:SS:SOURce.....	150
:BUS<x>:SPI:SS:THReshold	150
:BUS<x>:SPI:DATa{:OUT :MOSI}:THReshold	150
:BUS<x>:SPI:DATa{:IN :MOSI}:THReshold	151
:BUS<x>:SPI:WORDSize	151
:BUS<x>:SPI:BITORder	152
:BUS<x>:SPI:MOSI:SOURce	152
:BUS<x>:SPI:MISO:SOURce	153

Label Commands	:CHANnel<X>:LABel.....	154
	:CHANnel<X>:LABel:DISPlay.....	155
	:REF<X>:LABel.....	155
	:REF<X>:LABel:DISPlay	156
	:BUS<x>:LABel.....	157
	:BUS<x>:LABel:DISPlay	158

DVM Commands	:DVM:STATE	159
	:DVM:SOURce	159
	:DVM:MODE.....	159
	:DVM{RESET}.....	160
	:DVM:STATistics RESet.....	160
	:DVM:STATistics:MAXimum.....	160
	:DVM:STATistics:MINImum.....	161
	:DVM:STATistics:{AVG AVErage}.....	161
	:DVM:ALARm:MODE	162
	:DVM:ALARm:HIGHLimit.....	162
	:DVM:ALARm:LOWLimit.....	162
	:DVM:ALARm:WHEN.....	163
	:DVM:VALue	163

AWG Commands	:AWG<x>:AMPlitude.....	164
	:AWG<x>:FREQuency.....	164
	:AWG<x>:FUNCtion.....	165
	:AWG<x>:OFFSet.....	167
	:AWG<x>:OUTPut:LOAd:IMPEDance.....	167
	:AWG<x>:OUTPut:STATE.....	167
	:AWG<x>:PHASe.....	168
	:AWG<x>:PULSe:DUTYcycle.....	168
	:AWG<x>:RAMP:SYMmetry.....	168
	:AWG<x>:MODulation:STATE.....	168
	:AWG<x>:MODulation:TYPe.....	169
	:AWG<x>:MODulation:AM:DEPth.....	170
	:AWG<x>:MODulation:AM:FREQ.....	170
	:AWG<x>:MODulation:AM:SHApe.....	170
	:AWG<x>:MODulation:FM:DEV.....	171
	:AWG<x>:MODulation:FM:FREQ.....	171
	:AWG<x>:MODulation:FM:SHApe.....	171
	:AWG<x>:MODulation:FSK:FREQ.....	172
	:AWG<x>:MODulation:FSK:RATE.....	172
	:AWG<x>:SWEep:TYPe.....	172
	:AWG<x>:SWEep:START.....	173
	:AWG<x>:SWEep:STOP.....	173
	:AWG<x>:SWEep:TIME.....	173
	:AWG<x>:SWEep:SPAN.....	174
	:AWG<x>:SWEep:CENTer.....	174

FRA Commands	:FRA:RUN.....	175
	:FRA:STOP.....	175
	:FRA:FREQuency:START.....	176
	:FRA:FREQuency:STOP.....	176
	:FRA:POINt.....	176
	:FRA:DATA.....	177
	:FRA:SAVETOCsv.....	178
	:FRA:STATe.....	178

C COMMAND DETAILS

The Command details chapter shows the detailed syntax, equivalent panel operation, and example for each command. For the list of all commands, see page 6.

Common Commands	18
Mask Commands	22
Acquisition Commands	26
Autoscale Commands	34
Vertical Commands	35
Math Commands	40
Cursor Commands	49
Display Commands	63
Measure Commands	67
Measurement Commands	90
Reference Commands	100
Run Command	102
Stop Command	102
Force Command	102
Timebase Commands	103
Trigger Commands	106
System Commands	132
Save/Recall Commands	133
Bus Decode Commands	137
Label Commands	154
DVM Commands	159
AWG Commands	164
FRA Commands	175

Common Commands

*IDN? → Query

Description Returns the manufacturer, model, serial number and version number of the unit.

Syntax *IDN?

Example *IDN?
GW,GDS-2254HD,PXXXXXX,V1.XX

*RST Set →

Description Resets the GDS-2000HD/HG (recalls the default panel settings).

Syntax *RST

*CLS Set →

Description Clears the error queue.

Syntax *CLS

*ESE Set →
→ Query

Description Sets or queries the Standard Event Status Enable register.

Syntax *ESE <NR1>

Query Syntax *ESE?

Return parameter <NR1> 0~255

Bit Weight	Bit#	Weight	Event	Description
	0	1	OPC	Operation Complete Bit
	1	2	RQC	Not used

2	4	QYE	Query Error
3	8	DDE	Device Error
4	16	EXE	Execution Error
5	32	CME	Command Error
6	64	URQ	User Request
7	128	PON	Power On

Example *ESE?
 >4
 Indicates that there is a query error.

***ESR**

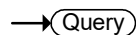

Description Queries the Standard Event Status (Event) register. The Event Status register is cleared after it is read.

Query Syntax *ESR?

Return parameter <NR1> 0~255

Bit Weight	Bit#	Weight	Event	Description
	0	1	OPC	Operation Complete Bit
	1	2	RQC	Not used
	2	4	QYE	Query Error
	3	8	DDE	Device Error
	4	16	EXE	Execution Error
	5	32	CME	Command Error
	6	64	URQ	User Request
	7	128	PON	Power On

Example *ESR?
 >4
 Indicates that there is a query error.

***OPC**

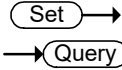

Description The *OPC command sets the OPC bit (bit0) of the Standard Event Status Register when all current commands have been processed.
The *OPC? Query returns 1 when all the outstanding commands have completed.

Syntax *OPC

Query Syntax *OPC?

Return parameter 1 Returns 1 when all the outstanding commands have completed.

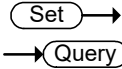

***SRE**

Description Sets or queries the Service Request Enable register. The Service Request Enable register determines which registers of the Status Byte register are able to generate service requests.

Syntax *SRE <NR1>

Query Syntax *SRE?

Parameter/Return parameter <NR1> 0~255

Bit Weight	Bit#	Weight	Event	Description
	0	1		Not used
	1	2		Not used
	2	4		Not used
	3	8		Not used
	4	16	MAV	Message Available Bit
	5	32	ESB	Event Status Bit
	6	64	MSS	Master Summary Bit
	6	64	RQS	Request Service Bit

	7	128		Not used
--	---	-----	--	----------

Example *SRE?
 >48
 Indicates that the MAVB and ESB bit are both set.

***STB** → Query

Description Queries the bit sum of the Status Byte register with MSS (Master summary Status) replacing the RQS bit (bit 6).

Query Syntax *STB?

Return parameter <NR1> 0 ~ 255

Bit Weight	Bit#	Weight	Event	Description
	0	1		Not used
	1	2		Not used
	2	4		Not used
	3	8		Not used
	4	16	MAV	Message Available Bit
	5	32	ESB	Event Status Bit
	6	64	MSS	Master Summary Bit
	6	64	RQS	Request Service Bit
	7	128		Not used

Example *STB?
 >16
 Indicates that the MAV bit is set.

Mask Commands

:MASK:STATe (Set) →
→ (Query)

Description	Set or query pass/ fail function status.	
Syntax	:MASK:STATE {ON OFF <NR1>} :MASK:STATe?	
Parameter	ON	Turn the mask function on.
	OFF	Turn the mask function off.
	<NR1>	is 0 to disable this function; other values to enable this function

Example :MASK:STATe ON
 Query pass/ fail function status to ON

:MASK:SOURce (Set) →
→ (Query)

Description	Sets or returns the compared source.	
Syntax	:MASK:SOURce {CH1 CH2 CH3 CH4} :MASK:SOURce?	
Parameter	CH1~CH4:	Channel 1 to Channel 4.

Example :MASK:SOURce CH1
 Set the compared source as channel 1.

:MASK:VIOLation (Set) →
→ (Query)

Description	Set or returns actions for the mask violations.	
Syntax	:MASK:VIOLation {STOP CONTInue} :MASK:VIOLation?	
Parameter	STOP	The waveform will be frozen.
	CONTInue	Ignore the violation.

Example :MASK:VIOLation STOP
Sets the violation action to stop.

Set →

:MASK:VIOLation:MODE

→ Query

Description Set or query pass/fail function type.

Syntax :MASK:VIOLation:MODE {PASS|FAIL}
:MASK:VIOLation:MODE?

Parameter PASS
FAIL

Example :MASK:VIOLation:MODE PASS
Set pass/fail type to PASS.

Set →

:MASK:VIOLation:BEEP

→ Query

Description Set or query the pass/fail beep function status.

Syntax :MASK:VIOLation:BEEP {ON|OFF|<NR1>}
:MASK:VIOLation:BEEP?

Parameter ON Enable beep function.
OFF Disable beep function.
<NR1> <NR1> is 0 to disable this function; other values to enable this function.

Example :MASK:VIOLation:BEEP ON
Set pass/fail beep function status to ON.

:MASK:SAVe (0 - 7)

Set →

Description Save rules as set 0 to set 7. (only 8 sets can be saved)

Syntax :MASK:SAVe <0 -7>

Parameter <0 - 7> File set and perform the save operation.

Example :MASK:SAVe 5
Save rules as 5th set

 Note Saving is invalid if the creation rule is not executed. When saving with existing data, it will directly overwrite the original data.

:MASK:RECALL (0 - 7) (Set) →

Description Read the corresponding pass/fail test rules.

Syntax :MASK:RECALL <QString>

Parameter <QString> Read the corresponding pass/fail test rules, 0-8.

Example :MASK:RECALL 2
Read pass/fail test rules from 2nd set

:MASK:RESults:FAILED → (Query)

Description Query number of frames failed during pass/fail test function.

Syntax :MASK:RESults:FAILED?

Example :MASK:RESults:FAILED?
:MASK:RESults:FAILED 0

:MASK:RESults:PASSEd → (Query)

Description Query number of frames passed during pass/fail test function.

Syntax :MASK:RESults:PASSEd?

Example :MASK:RESults:PASSEd?
:MASK:RESults:PASSEd 473

:MASK:RESults:TOTal

→ Query

Description Query total frames number of during pass/fail test function.

Syntax :MASK:RESults:TOTal?

Example :MASK:RESults:TOTal?
:MASK:RESults:TOTal 764

Set →

→ Query

:MASK:AUTO

Description Creates a mask fast in according to the reference source. Or returns the setting of the mask.

Syntax :MASK:AUTO {<Xmask>,<Ymask>}
:MASK:AUTO?

Parameter <Xmask> Sets the horizontal range for the mask.
<Ymask> Sets the vertical range for the mask.

Example :MASK:AUTO 0.2,1.2
Sets the range of mask as {0.2,1.2} and creates a mask.

Set →

→ Query

:MASK:RESults:DISPlay



Description Sets or queries the display state of mask results menu.



Syntax :MASK:RESults:DISPlay {ON|OFF}
:MASK:RESults:DISPlay?

Parameter ON Turns on the mask results menu.
OFF Turns off the mask results menu.

Example :MASK:RESults:DISPlay ON
:MASK:RESults:DISPlay?
ON

Acquisition Commands

				
:ACQuire:AVERage				
Description	Selects or returns the number of waveform acquisitions that are averaged in the average acquisition mode.			
Syntax	:ACQuire:AVERage {<NR1> ?}			
Related Commands	:ACQuire:MODE			
Parameter	<table border="1"> <tr> <td style="background-color: #e0e0e0;"><NR1></td> <td>2, 4, 8, 16, 32, 64, 128, 256, 512, 1024, 2048, 4096, 8192, 16384, 32768, 65536</td> </tr> </table>		<NR1>	2, 4, 8, 16, 32, 64, 128, 256, 512, 1024, 2048, 4096, 8192, 16384, 32768, 65536
<NR1>	2, 4, 8, 16, 32, 64, 128, 256, 512, 1024, 2048, 4096, 8192, 16384, 32768, 65536			
Note	Before using this command, select the average acquisition mode. See the example below.			
Example	<pre>:ACQuire:MODE AVERage :ACQuire:AVERage 2</pre> <p>Selects the average acquisition mode, and sets the average number to 2.</p>			

										
:ACQuire:MODE										
Description	Selects or returns the acquisition mode.									
Syntax	:ACQuire:MODE {SAMPlE PDETECT HIRES AVERage ?}									
Related Commands	:ACQuire:AVERage									
Parameter	<table border="1"> <tr> <td style="background-color: #e0e0e0;">SAMPlE</td> <td>Sample mode sampling</td> </tr> <tr> <td style="background-color: #e0e0e0;">PDETECT</td> <td>Peak detect sampling</td> </tr> <tr> <td style="background-color: #e0e0e0;">HIRES</td> <td>High Resolution sampling</td> </tr> <tr> <td style="background-color: #e0e0e0;">AVERage</td> <td>Average sampling mode</td> </tr> </table>		SAMPlE	Sample mode sampling	PDETECT	Peak detect sampling	HIRES	High Resolution sampling	AVERage	Average sampling mode
SAMPlE	Sample mode sampling									
PDETECT	Peak detect sampling									
HIRES	High Resolution sampling									
AVERage	Average sampling mode									

Example :ACQuire:MODE PDETECT
 Sets the sampling mode to peak detection.

:ACQuire<X>:MEMory? → Query

Description Returns the data in acquisition memory for the selected channel as a header + raw data.

Syntax :ACQuire<X>:MEMory?

Related Commands :ACQuire:RECOrdlength
 :HEADer

Parameter	<X>	Channel number (1 to 4)
Return parameter	<string> <waveform block data>	<p>Returns acquisition settings followed by raw waveform block data.</p> <p><string> Returns the acquisition settings for the selected channel.</p> <p>Format: parameter(1),setting(1);parameter(2),setting(2)...parameter(n),setting(n);Waveform Data;</p> <p><waveform block data> Header followed by the raw waveform data.</p> <p>Format: Header: The header (in ASCII) encodes the number of bytes for the header followed by the number of data points in bytes for the raw data.</p>

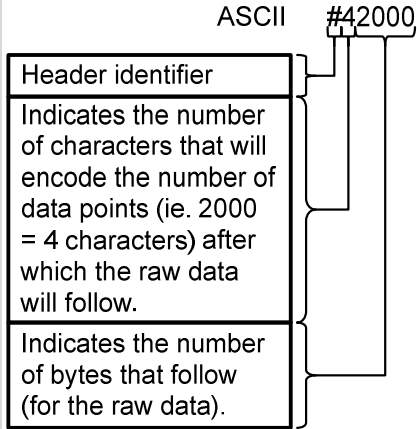

Raw Data:

Each two bytes (in hex) encodes the vertical data of a data point. The data is signed hex data (2's complement, -32768 ~ 32767).

Waveform Raw Data Example:

Header raw data.....

Hex:

23 34 32 30 30 30 00 1C 00 1B 00 1A 00
1A 00 1B

ASCII/Decimal:

#42000 28 27 26 26 27.....

The actual value of a data point can be calculated with the following formula:

(Decimal value of hex data / AD Factor) * vertical scale.

Note: AD Factor is fixed as 25. The vertical scale is returned with the acquisition settings that precede the raw data.

For example if the raw data for a

point is 001C (=28 decimal) then,
 $(28/25) \times 0.5 = 0.56V$

Example :ACquire1:MEMory?
 Format,3.0HD;Memory
 Length,10000;IntpDistance,0;Trigger
 Address,49;Trigger
 Level,2.3200;Source,CH1;Vertical Units,V;Vertical
 Units Extend Div,0;Label,ACK;Probe Type,0;Probe
 Ratio,10.0000;Vertical Scale,1.0000;Vertical
 Position,-560.0000E-3;Horizontal
 Units,s;Horizontal Scale,100.0000E-6;Horizontal
 Position,420.0000E-6;Horizontal
 Mode,Main;SincET Mode,Real Time;Sampling
 Period,200.0000E-9;Horizontal Old
 Scale,100.0000E-6;Horizontal Old
 Position,420.0000E-6;Firmware,V1.16;Time,18-Dec-
 25 17:16:07;Data Bit,12;AD Factor,400; Waveform
 Data;
 #520000.....follows waveform block
 data in hex.....

:ACquire:FILTer:SOURce

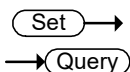

Description	Returns the source of the filter.
Syntax	:ACquire:FILTer:SOURce {CH1 CH2 CH3 CH4 ?}
Parameter/ Return parameter	CH1 ~ CH4 Source channel
Example	:ACquire:FILTer:SOURce? CH1 Sets the filter source to CH1.

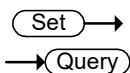

:ACquire:FILTer

Description	Turns the filter on/off or queries its status.
Syntax	:ACquire:FILTer {ON OFF ?}

Parameter/	ON	Filter on.
Return parameter	OFF	Filter off.

Example :ACquire:FILTer?
OFF
Indicates that the filter is turned off.

Set →
→ Query

:ACquire:FILTer:FREquency:UPPER

Description	Sets or returns the filter upper frequency.	
Syntax	:ACquire:FILTer:FREquency:UPPER {Default} :ACquire:FILTer:FREquency:UPPER <Nrf> :ACquire:FILTer:FREquency:UPPER?	

Parameter	DEfault	Sets the frequency to default.
	<Nrf>	Sets the frequency to user. (Range: 1Hz ~ 500MHz)

Example :ACquire:FILTer:FREquency:UPPER 4.95e+07
:ACquire:FILTer:FREquency:UPPER?
4.950000e+07

Set →
→ Query

:ACquire:FILTer:FREquency:LOWER

Description	Sets or returns the filter lower frequency.	
Syntax	:ACquire:FILTer:FREquency:LOWER {Default} :ACquire:FILTer:FREquency:LOWER <Nrf> :ACquire:FILTer:FREquency:LOWER?	

Parameter	DEfault	Sets the frequency to default.
	<Nrf>	Sets the frequency to user. (Range: 1Hz ~ 500MHz)

Example :ACquire:FILTer:FREquency:LOWER 1.25e+07
:ACquire:FILTer:FREquency:LOWER?
1.250000e+07

:ACquire:FILTer:TYPe



Description	Sets or returns the filter type.	
Syntax	:ACquire:FILTer:TRACkING {LOWPass HIGHPass BANDPass BANDReject} :ACquire:FILTer:TYPe?	
Parameter	LOWPass	Lowpass Type.
	HIGHPass	Highpass Type.
	BANDPass	Bandpass Type.
	BANDReject	Bandreject Type
Example	:ACquire:FILTer:TYPe? >LOWPass Returns low pass type as present filter type	

:ACquire:FILTer:WINDow



Description	Query or set the window for filter function.	
Syntax	:ACquire:FILTer:WINDow {RECTangular HAMming HANning BLAckman TAPered TRIAngular} :ACquire:FILTer:WINDow?	
Example	:ACquire:FILTer:WINDow RECTangular Set filter window type to RECTangular	

:ACquire:FILTer:VERTical:POSition



Description	Query or set the vertical position of the filter function.	
Syntax	:ACquire:FILTer:VERTical:POSition <NR3> :ACquire:FILTer:VERTical:POSition ?	

Parameter	<code><NR3></code>	Is a float number that specifies the desired position from the center grid division. The range is ± 5 divisions, with a resolution of 0.01 divisions.
-----------	--------------------------	---

Example :ACQuire:FILTer:VERTical:POSition 1
Set the vertical position of the filter to 1div

:ACQuire<X>:STATe? → Query

Description	Returns the status of waveform data.
-------------	--------------------------------------

Syntax	:ACQuire<X>:STATe?
--------	--------------------

Parameter	<code><X></code>	Channel number (1 to 4)
-----------	------------------------	-------------------------

Return parameter	0	Raw data is not ready
	1	Raw data is ready

Example :ACQuire1:STATe?
0
Returns 0. Channel 1's raw data is not ready.

 **Note** If the oscilloscope changes the acquisition status from STOP to RUN, the status will be reset as zero.

Set →

:ACQuire:INTERpolation → Query

Description	Selects or returns the interpolation mode.
-------------	--

Syntax	:ACQuire:INTERpolation {ET SINC ?}
--------	--

Parameter/Return parameter	ET	Equivalent Time interpolation. The GDS-2000HD/HG doesn't support ET.
	SINC	Sets to SIN(X)/X interpolation

Example :ACQuire:INTERpolation?
>SINC
Returns SINC as the interpolation mode.

Set →
 → Query

Description	Sets or queries the record length.
Syntax	:ACQUIRE:RECORDlength {<NRf> ?}
Parameter/Return parameter	<NRf> Record length. Settable record length: (1e+3 1e+4 1e+5 1e+6 1e+7 1e+8)
Example	:ACQUIRE:RECORDlength 1e+3 Sets the record length to 1000 points.

→ Query

Description	Queries the value of sample rate.
Syntax	: ACQUIRE:SAMPLerate?
Example	: ACQUIRE:SAMPLerate? 1.00000E+09

Autoscale Commands

:AUTOSet.....34

:AUTOSet

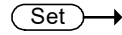

Description	Runs the Autoset function to automatically configure the horizontal scale, vertical scale, and trigger according to the input signal.
-------------	---

Syntax	:AUTOSet
--------	----------

Vertical Commands

:CHANnel<X>:BWLimit
 →
 →

Description	Sets or returns the bandwidth limit on/off.	
Syntax	:CHANnel<X>:BWLimit {FULL <NR3> ?}	
Parameter	<X>	Channel 1, 2, 3, 4
	FULL	Full bandwidth
	<NR3>	Sets the bandwidth limit to a pre-defined bandwidth.
		100E+6: 100MHz
		20E+6: 20MHz
Return Parameter	<NR3>	Returns the bandwidth.
	Full	Full bandwidth
Example	:CHANnel1:BWLimit 2.000E+07 Sets the channel 1 bandwidth to 20MHz.	

:CHANnel<X>:COUPling
 →
 →

Description	Selects or returns the coupling mode.	
Syntax	CHANnel<X>:COUPling {AC DC GND ?}	
Parameter	<X>	Channel 1, 2, 3, 4
	AC	AC coupling
	DC	DC coupling
	GND	Ground coupling
Return parameter	Returns the coupling mode.	
Example	:CHANnel1:COUPling DC Sets the coupling to DC for Channel 1.	

:CHANnel<X>:DISPlay (Set) →
→ (Query)

Description	Turns a channel on/off or returns its status.	
Syntax	:CHANnel<X>:DISPlay {OFF ON ?}	
Parameter	<X>	Channel 1, 2, 3, 4
	OFF	Channel off
	ON	Channel on
Return Parameter	ON	Channel is on
	OFF	Channel is off
Example	:CHANnel1:DISPlay ON Turns on Channel 1	

:CHANnel<X>:EXPand (Set) →
→ (Query)

Description	Sets Expand By Ground or Expand By Center for a channel or queries its status.	
Syntax	:CHANnel<X>:EXPand {GND CENTER ?}	
Parameter	<X>	Channel 1, 2, 3, 4
	GND	Ground
	CENTER	Center
Return parameter	GND	Expand By Ground
	CENTER	Expand By Center
Example	:CHANnel1:EXPand GND Sets Channel 1 to Expand By Ground.	

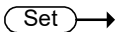
:CHANnel<X>:IMPedance

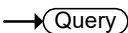

Description	Sets or returns the impedance of the oscilloscope.	
Syntax	:CHANnel<X>:IMPedance {50 1M ?} :CHANnel<X>:IMPedance?	
Parameter	<x> 1/2/3/4	Channel CH1/2/3/4
Return parameter	<NR3>	Returns the impedance value.
Example	:CHANnel1:IMPedance? 1.000000E+06 The impedance is 1M ohms.	

:CHANnel<X>:INVert



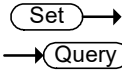

Description	Inverts a channel or returns its status.	
Syntax	:CHANnel<X>:INVert {OFF ON ?}	
Parameter	<X> OFF ON	Channel 1, 2, 3, 4 Invert off Invert on
Return parameter	ON OFF	Invert on Invert off
Example	:CHANnel1:INVert ON Inverts Channel 1	

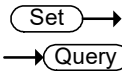

:CHANnel<X>:POSition

Description	Sets or returns the position level for a channel.	
Note	<p>The vertical position will only be set to closest allowed value. The position level range depends on the vertical scale.</p> <p>The scale must first be set before the position can be set.</p>	
Syntax	:CHANnel<X>:POSition { <NRf> ?}	
Parameter	<X>	Channel 1, 2, 3, 4
	<NRf>	Position. Range depends on the vertical scale.
Return parameter	<NR3>	Returns the position value.
Example 1	<p>:CHANnel1:POSition 2.4E-3</p> <p>Sets the Channel 1 position to 2.4mV/mA</p>	
Example 2	<p>:CHANnel1:POSition?</p> <p>2.4E-3</p> <p>Returns 2.4mV as the vertical position.</p>	



:CHANnel<X>:PROBe:RATio

Description	Sets or returns the probe attenuation factor.	
Syntax	:CHANnel<X>:PROBe:RATio { <NRf> ?}	
Related Commands	:CHANnel<X>:PROBe:TYPE	
Parameter	<X>	Channel 1, 2, 3, 4
	<NRf>	Probe attenuation factor
Return parameter	<NR3>	Returns the probe factor
Example	<p>:CHANnel1:PROBe:RATio 1.00E+0</p> <p>Sets the Channel 1 probe attenuation factor to 1x</p>	

:CHANnel<X>:PROBE:TYPE



Description	Sets or returns the probe type (voltage/current).	
Syntax	:CHANnel<X>:PROBE:TYPE { VOLTage CURRent POWer UNKNown ?}	
Related Commands	:CHANnel<X>:PROBE:RATio	
Parameter	<X>	Channel 1, 2, 3, 4
	VOLTage	Voltage
	CURRent	Current
	POWer	Power
	UNKNown	Unknow

Return parameter Returns the probe type.

Example :CHANnel1:PROBE:TYPE VOLTage
Sets the Channel 1 probe type to voltage.

:CHANnel<X>:SCALE



Description	Sets or returns the vertical scale. The scale depends on the probe attenuation factor. Note the probe attenuation factor should be set before the scale.	
Syntax	:CHANnel<X>:SCALE { <NRf> ?}	
Parameter	<X>	Channel 1, 2, 3, 4
	<NRf>	Vertical scale: 2e-3 to 1e+1 2mV to 10V (Probe x1)
Return parameter	<NR3>	Returns the vertical scale in volts or amps.

Example :CHANnel1:SCALE 2.00E-2
Sets the Channel 1 vertical scale to 20mV/div

Math Commands

:MATH:DISP (Set) →
→ (Query)

Description	Turns the math display on or off on the screen.	
Syntax	:MATH:DISP {OFF ON ?}	
Parameter/ Return parameter	OFF	Math is not displayed on screen
	ON	Math is displayed on screen
Example	:MATH:DISP OFF Math is off.	

:MATH:TYPE (Set) →
→ (Query)

Description	Queries or sets the Math type to FFT, Advanced Math or to dual channel math operations	
Syntax	:MATH:TYPE { DUAL ADVanced FFT ? }	
Related Commands	:MATH:DISP	
Parameter	DUAL	Dual channel operations
	ADVanced	Advanced math operations
	FFT	FFT operations
Return parameter	Returns the math type.	
Example	:MATH:TYPE DUAL Sets the Math type to dual channel math operation.	

:MATH:DUAL:SOURce<X> (Set) →
→ (Query)

Description	Sets the dual math source for source 1 or 2.	
Syntax	:MATH:DUAL:SOURce<X> { CH1 CH2 CH3 CH4 ? }	

Parameter	<X> CH1~4	Source number 1 or 2 Channel 1 to 4
Return parameter	Returns the source for the source 1 or 2.	
Example	:MATH:DUAL:SOURce1 CH1 Sets source1 as channel 1.	

:MATH:DUAL:OPERator

Set →

→ Query

Description	Sets the math operator for dual math operations.	
Syntax	:MATH:DUAL:OPERator {PLUS MINUS MUL DIV ?}	
Parameter	PLUS MINUS MUL DIV	+ operator - operator × operator ÷ operator
Return parameter	Returns operator type.	
Example	:MATH:DUAL:OPERator PLUS Sets the math operator as plus (+).	

Set →

→ Query

:MATH:DUAL:POSition

Description	Sets the vertical position of the displayed math result expressed by unit/division.	
Syntax	:MATH:DUAL:POSition {<NRf> ? }	
Parameter	<NRf>	Vertical position Depends on the vertical scale (Unit/Div)
Return parameter	<NR3>	Returns the vertical position.
Example	:MATH:DUAL:POSition 1.0E+0 Sets the vertical position to 1.00 unit/div.	

Set →
 → Query

:MATH:DUAL:SCALE

Description	Sets the vertical scale of the displayed math result.	
Syntax	:MATH:DUAL:SCALE {<NRf> ?}	
Parameter	<NRf>	Vertical scale
Return parameter	<NR3>	Returns the scale.
Example	:MATH:DUAL:SCALE 2.0E-3 Sets the vertical scale to 2mV/2mA.	

Set →
 → Query

:MATH:FFT:SOURce

Description	Sets and queries the FFT math source.	
Syntax	:MATH:FFT:SOURce { CH1 CH2 CH3 CH4 ? }	
Related commands	:MATH:ADVanced:EDIT:SOURce<X> :MATH:ADVanced:EDIT:OPERator	
Parameter	CH1~4	Channel 1 to 4
Return parameter	Returns the FFT source.	
Example	:MATH:FFT:SOURce CH1 Sets the FFT math source as channel 1.	

Set →
 → Query

:MATH:FFT:MAG

Description	Sets FFT vertical units as linear or decibels.	
Syntax	:MATH:FFT:MAG {LINEAR DB RADIans DEGrees ?}	
Parameter	LINEAR	Linear units (Vrms)
	DB	Logarithmic units (dB)
	RADIANS	Radians units
	DEGRESS	Degree unit
Return parameter	Returns the FFT vertical units.	

Example :MATH:FFT:MAG DB
Sets FFT vertical units to dB.

:MATH:FFT:WINDow (Set) →
→ (Query)

Description Sets the windowing filter used for the FFT function.

Syntax :MATH:FFT:WINDow
{RECTangular|HAMming|HANning|BLAckman|BARTlett|KAISer|?}

Parameter	RECTangular	Rectangular window
	HAMming	Hamming window
	HANning	Hanning window
	BLAckman	Blackman window
	BARTlett	Bartlett window
	KAISer	Kaise window

Return parameter Returns the FFT window.

Example :MATH:FFT:WINDow HAMming
Sets the FFT window filter to hamming.

:MATH:FFT:POSition (Set) →
→ (Query)

Description Sets the vertical position of the displayed FFT result.

Syntax MATH:FFT:POSition { <NRf> | ? }

Parameter <NRf> Vertical position: -12e+0 to +12e+0
(12 units/division to +12 units/division.)

Return parameter <NR3> Returns the vertical position.

Example :MATH:FFT:POSition -2e-1
Sets the FFT position to -0.2 divisions.

:MATH:FFT:SCALE

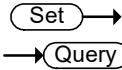

Description	Sets the vertical scale of the displayed FFT result.	
Syntax	:MATH:FFT:SCALE {<NRf> ?}	
Parameter	<NRf>	Vertical scale: Linear: 2e-3 to 1e+3 (2mV~1kV) dB: 1e+0 to 2e+1 (1~20dB)
Return parameter	<NR3>	Returns vertical scale.
Example	:MATH:FFT:SCALE 1.0e+0 Sets the scale to 1dB.	

:MATH:FFT:HORizontal:SCALE

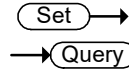

Description	Sets or queries the zoom scale for FFT math.	
Syntax	:MATH:FFT:HORizontal:SCALE {<NRf> ?}	
Parameter	<NRf>	Zoom scale: 1 to 20 times
Return parameter	<NR3>	Returns zoom scale.
Example	:MATH:FFT:HORizontal:SCALE 5 Sets the zoom scale to 5X.	

:MATH:FFT:HORizontal:POSition

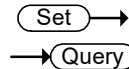

Description	Sets the horizontal position of the displayed FFT result.	
Syntax	MATH:FFT:HORizontal:POSition { <NRf> ? }	
Parameter	<NRf>	Horizontal position: 0Hz ~ 999.9kHz
Return parameter	<NR3>	Returns the vertical position.
Example	:MATH:FFT:HORizontal:POSition 6.0e5 Sets the FFT horizontal position to 600kHz.	

:MATH:FFT:PEAKSTable:DISPlay



Description	Query or set the peak display of FFT function.	
Syntax	:MATH:FFT:PEAKSTable:DISPlay {ON OFF <NR1>} :MATH:FFT:PEAKSTable:DISPlay?	
Parameter	OFF	Disable peak display function.
	ON	Enable peak display function.
	<NR1>	0 is to disable this function; other values to enable this function.
Example	:MATH:FFT:PEAKSTable:DISPlay ON Set FFT peak display to ON	

:MATH:FFT:PEAKSTable: NUM





Description	Set or query the number of peak display for FFT function.	
Syntax	:MATH:FFT:PEAKSTable:NUM <NR1> :MATH:FFT:PEAKSTable:NUM?	
Parameter	<NR1>	Range is 1-15.
Example	:MATH:FFT:PEAKSTable:NUM 15 Set FFT peak display count to 5	

:MATH:FFT:PEAKSTable:THReshol



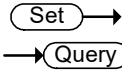

Description	Set or query FFT function peak threshold.	
Syntax	:MATH:FFT:PEAKSTable:THReshold<NR3> :MATH:FFT:PEAKSTable:THReshold?	
Parameter	<NR3>	Unit: V, db, rad; Maximum value is the current vertical position*5.
Example	:MATH:FFT:PEAKSTable:THReshold 1 Set FFT peak threshold to 1	

:MATH:FFT:PEAKSTable:ORDER

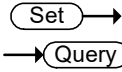

Description	Query or set the peak display of FFT function.
Syntax	:MATH:FFT:PEAKSTable:ORDER {AMPlitude FREQuency} :MATH:FFT:PEAKSTable:ORDER?
Parameter	AMPlitude Sort by peak size. FREQuency Sort by frequency size.
Example	:MATH:FFT:PEAKSTable:ORDER AMPlitude Set FFT peak sort method to AMPlitude

:MATH:DEFine



Description	Sets or queries the advanced math expression as a string.										
Syntax	:MATH:DEFine {<string> ?}										
Related	:MATH:DISP :MATH:TYPE										
Parameter	<p><string> An expression enclosed in double quotes. Note that ensure parentheses are used correctly in the expression. The expression can contain the following parts:</p> <table border="1"> <tr> <td>Source</td> <td>CH1~CH4, Ref1~Ref4</td> </tr> <tr> <td>Function</td> <td>Intg(, Diff(, log(, ln(, Exp(, Sqrt(, Abs(, Rad(, Deg(, sin(, cos(, tan(, asin(, acos(, atan(</td> </tr> <tr> <td>Variable</td> <td>VAR1, VAR2</td> </tr> <tr> <td>Operator</td> <td>+, -, *, /, (,), !(, <, >, <=, >=, ==, !=, , &&</td> </tr> <tr> <td>Figure</td> <td>0, 1, 2, 3, 4, 5, 6, 7, 8, 9, ., E</td> </tr> </table>	Source	CH1~CH4, Ref1~Ref4	Function	Intg(, Diff(, log(, ln(, Exp(, Sqrt(, Abs(, Rad(, Deg(, sin(, cos(, tan(, asin(, acos(, atan(Variable	VAR1, VAR2	Operator	+, -, *, /, (,), !(, <, >, <=, >=, ==, !=, , &&	Figure	0, 1, 2, 3, 4, 5, 6, 7, 8, 9, ., E
Source	CH1~CH4, Ref1~Ref4										
Function	Intg(, Diff(, log(, ln(, Exp(, Sqrt(, Abs(, Rad(, Deg(, sin(, cos(, tan(, asin(, acos(, atan(
Variable	VAR1, VAR2										
Operator	+, -, *, /, (,), !(, <, >, <=, >=, ==, !=, , &&										
Figure	0, 1, 2, 3, 4, 5, 6, 7, 8, 9, ., E										

		Measurement	Pk-Pk(, Max(, Min(, Amp(, High(, Low(, Mean(, CycleMean(, RMS(, CycleRMS(, Area(, CycleArea(, ROVShoot(, FOVShoot(, Freq(, Period(, Rise(, Fall(, PosWidth(, NegWidth(, Dutycycle(, FRR(, FRF(, FFR(, FFF(, LRR(, LRF(, LFR(, LFF(, Phase(
--	--	-------------	--

Return parameter Returns the expression as a string.

Example :MATH:DISP ON
 :MATH:TYPE ADVanced
 MATH:DEFine "CH1+ CH2"
 Sets the math expression to CH1+CH2.

:MATH:LABel



Description	Set or query FFT function's label.	
Syntax	:MATH:LABel <QString> :MATH:LABel?	
Parameter	<NR3>	Unit is Hz, scientific notation.
Return parameter		

Example :MATH:LABel "abc"
 Set FFT label name to abc

:MATH:LABel:DISPlay

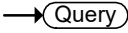

Description	Sets or returns the waveform label for MATH on/off.	
Syntax	:MATH:LABel:DISPlay {OFF ON} :MATH:LABel:DISPlay?	

Related Commands :MATH:LABel

Related Commands :MATH:LABel "MATH1"
 Example :MATH:LABel?
 MATH1

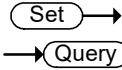

:MATH:ADVanced:POSition

Description Sets the vertical position of the advanced math result, expressed in unit/div.

Syntax MATH:ADVanced:POSition { <NRf> | ? }

Parameter <NRf> Vertical position: -12e+0 to +12e+0 (12 units/division to +12 units/division.)

Return parameter <NR3> Returns the vertical position.

Example :MATH:ADVanced:POSition 1.0e+0
 Sets the position as 1.00 unit/div.

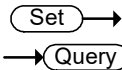

:MATH:ADVanced:SCALE

Description Sets or queries the vertical scale the advanced math result.

Syntax :MATH:ADVanced:SCALE {<NRf> | ?}

Parameter <NRf> Vertical scale

Return parameter <NR3> Returns the vertical scale.

Example :MATH:ADVanced:SCALE 2.0E-3
 Sets the vertical scale to 2mV/Div.

Cursor Commands

:CURSor:MODE

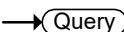

Description Sets cursor mode to horizontal (H) or horizontal and vertical (HV).

 **Note** When the cursor source is set to bus, then only the horizontal cursor is available.

Syntax :CURSor:MODE {OFF | H | HV | V |? }

Parameter	OFF	Turns the cursors off.
	H	Turns the horizontal cursors on.
	HV	Turns horizontal and vertical cursors on.
	V	Turns vertical cursors on

Return parameter Returns the state of the cursors (H, HV, OFF).

Example :CURSor:MODE OFF
Turns the cursors off.

:CURSor:SOURce





Description Sets or queries the cursor source.

Syntax :CURSor:SOURce {CH1 | CH2 | CH3 | CH4 | MATH | FFT | AUTO |? }

Parameter	CH1~CH4	Channel 1 to 4
	MATH	Math source
	FFT	Cursor source is selected as FFT.
	AUTO	Cursor source selection follows the channel.

Return parameter Returns the cursor source.

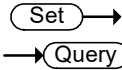
Example :CURSor:SOURce CH1
Turns the cursor source as channel 1.



:CURSor:HUNI

Description	Sets or queries the units for the horizontal bar cursors.	
Syntax	:CURSor:HUNI {SEConds HERTz DEGrees PERcent ?}	
Related Commands	:CURSor:MODE	
Parameter	SEConds	Sets the cursor units to time in seconds.
	HERTz	Sets the cursor units to frequency.
	DEGrees	Sets the cursor units to degrees.
	PERcent	Sets the cursor units to percent.
Return parameter	Returns the unit type.	
Example	:CURSor:HUNI SEConds Sets the units to time in seconds.	

:CURSor:HUSE

Set →

Description	Sets the current cursor position as the phase or ratio reference for the Percent cursors.
Note	This command can only be used when :CURSor:HUNI is set to PERcent.
Syntax	:CURSor:HUSE {CURRent}
Related Commands	:CURSor:MODE :CURSor:HUNI
Parameter	CURRent Uses the current horizontal position
Example	:CURSor:HUSE CURRent.

:CURSor:VUNI

Set →
→ Query

Description	Sets or queries the units for the vertical bar cursors.
Syntax	:CURSor:VUNI {BASE PERcent ?}
Related Commands	:CURSor:MODE
Parameter	BASE Sets the vertical cursor units the same as the scope units (V or A). PERcent Sets the displayed units to percent.
Return parameter	Returns the unit type.
Example	:CURSor:VUNI BASE Sets the units to the base units.

:CURSor:VUSE

Set →

Description	Sets the current cursor position as the ratio reference for the Percent (vertical) cursors.
Note	This command can only be used when :CURSor:VUNI is set to PERcent.

Syntax	:CURSor:VUSE {CURRent}
Related Commands	:CURSor:MODE :CURSor:VUNI
Parameter	CURRent Uses the current vertical position
Example	:CURSor:VUSE CURRent.

:CURSor:H1Position

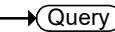

Description	Sets or returns the first horizontal cursor (H1) position.
Syntax	:CURSor:H1Position {<NRf ?}
Related Commands	:CURSor:H2Position
Parameter	<NRf> Horizontal position
Return parameter	Returns the cursor position.
Example	:CURSor:H1Position? -1.34E-3 Returns the H1 cursor position as -1.34ms.

:CURSor:H2Position



Description	Sets or returns the second horizontal cursor (H2) position.
Syntax	:CURSor:H2Position {<NRf> ?}
Related Commands	:CURSor:H1Position
Parameter	<NRf> Horizontal Position
Return parameter	Returns the cursor position.
Example	:CURSor:H2Position 1.5E-3 Sets the H2 cursor position to 1.5ms.

:CURSor:HDELta

→ Query

Description	Returns the delta of H1 and H2.
Syntax	:CURSor:HDELta{?}
Return Parameter	<NR3> Returns the distance between two horizontal cursors.
Example	:CURSor:HDELta? 5.0E-9 Returns the horizontal delta as 5ns.

Set →
 → Query

:CURSor:V1Position

Description	Sets the first vertical cursor (V1) position.	
Syntax	:CURSor:V1Position {<NRf> ?}	
Parameter	<NRf>	Vertical position. Depends on the vertical scale.
Return parameter	<NR3>	Returns the cursor position.
Example	:CURSor:V1Position 1.6E -1 Sets the V1 cursor position to 160mA.	

Set →
 → Query

:CURSor:AREA

Description	Query or set the cursor waveform area.		
Syntax	:CURSor:AREA {MAIN ZOOM XY FFT EXPANsion} :CURSor:AREA?		
 Note	After enabling the XY FFT ZOOM function, it can be set. If there is only one waveform area, it can only be MAIN; subsequent basic commands need to determine the area to which the current waveform area belongs and return the cursor information corresponding to the waveform area.		
	Parameter	MAIN	Set the waveform area as the main waveform area.
		ZOOM	Set the waveform area as ZOOM (requires ZOOM to be enabled).
		XY	Set the waveform area as XY (requires XY to be enabled).
		FFT	Set the waveform area to FFT (requires FFT to be enabled).
	EXPANsion	Set to the extended area, i.e., in ZOOM mode set to the ZOOM window, in FFT mode set to the FFT window, and in XY mode set to the XY window.	

Example :CURSor:AREA MAIN
Set cursor waveform area to MIAN.

Set →

:CURSor:V2Position

→ Query

Description Sets the first vertical cursor (V2) position.

Syntax :CURSor:V2Position {<NRf> | ?}

Parameter <NRf> Vertical position. Depends on the vertical scale.

Return parameter <NR3> Returns the cursor position.

Example :CURSor:V2Position 1.1E-1
Sets the V2 cursor position to 110mA.

:CURSor:VDELta

→ Query

Description Returns the delta of V1 and V2.

Syntax :CURSor:VDELta{?}

Return Parameter <NR3> Returns the difference between two vertical cursors.

Example :CURSor:VDELta?
4.00E+0
Returns the vertical delta as 4 volts.

Set →

:CURSor:TIME:TYPE

→ Query

Description Set or query automatic cursor toggle.

Syntax :CURSor:TIME:TYPE {MANual|AUTO}
:CURSor:TIME:TYPE?

Parameter MANual Set cursor mode to manual.

AUTO Set cursor mode to automatic.

Example :CURSor:TIME:TYPE AUTO
Set cursor mode to automatic.

:CURSor:XY:RECTangular:X:UNIts → Query

Description Query returns the X module unit of Rectangular module in XY mode.

Syntax :CURSor:XY:RECTangular:X:UNIts?

Example :CURSor:XY:RECTangular:X:UNIts?
Query the X module unit of Rectangular module in XY mode

:CURSor:XY:RECTangular:X:POSition<X> Set →
→ Query

Description Sets or queries the horizontal position in XY mode for the X rectangular coordinates for cursor 1 or 2.

Syntax :CURSor:XY:RECTangular:X:POSition<X> {<NRf>|?}

Parameter	<X>	Cursor 1, 2
	<NRf>	Horizontal position co-ordinates

Return parameter	<NR3>	Returns the cursor position.
------------------	-------	------------------------------

Example :CURSor:XY:RECTangular:X:POSition1 4.0E-3
Sets the X-coordinate cursor 1 position to 40mV/mV.

:CURSor:XY:RECTangular:X:DELta → Query

Description Returns the delta value of cursor 1 and 2 on the X coordinate.

Syntax :CURSor:XY:RECTangular:X:DELta{?}

Return Parameter	<NR3>	Returns the delta value of cursor 1 and 2 as <NR3>.
------------------	-------	---

Example :CURSor:XY:RECTangular:X:DELta? 80.0E-3
Returns the horizontal delta as 80mV.

:CURSor:XY:RECTangular:Y:UNIts → Query

Description Query returns the Y module unit of Rectangular module in XY mode.

Syntax :CURSor:XY:RECTangular:Y:UNIts?

Example :CURSor:XY:RECTangular:Y:UNIts?
Query the Y module unit of Rectangular module in XY mode.

:CURSor:XY:RECTangular:Y:POSition<X> Set →
→ Query

Description Sets or queries the vertical position in XY mode for the Y rectangular coordinates for cursor 1 or 2.

Syntax :CURSor:XY:RECTangular:Y:POSition<X> {<NRf>|?}

Parameter	<X>	Cursor 1, 2
	<NRf>	Vertical position co-ordinates

Return parameter **<NR3>** Returns the cursor position.

Example :CURSor:XY:RECTangular:Y:POSition1 4.0E-3
Sets the Y-coordinate cursor 1 position to 40mV/mV.

:CURSor:XY:RECTangular:Y:DELta → Query

Description Returns the delta value of cursor 1 and 2 on the Y coordinate.

Syntax :CURSor:XY:RECTangular:Y:DELta{?}

Return Parameter	<NR3>	Returns the delta value of cursor 1 and 2 as <NR3>.
------------------	--------------------	---

Example :CURSor:XY:RECTangular:Y:DELta?
80.0E-3
Returns the horizontal delta as 80mV.

:CURSor:XY:POLar:RADIUS:UNITs →(Query)

Description Query retrieves the unit of r in the Polar module in XY mode.

Syntax :CURSor:XY:POLar:RADIUS:UNITs?

Example :CURSor:XY:POLar:RADIUS:UNITs?
Query the unit of r in the Polar module in XY mode.

:CURSor:XY:POLar:RADIUS:POSition<X> →(Query)

Description Queries the polar radius position for the specified cursor in XY mode, where X can be either cursor 1 or 2.

Syntax :CURSor:XY:POLar:RADIUS:POSition<X>{?}

Parameter <X> 1, 2 (cursor 1, cursor 2)

Return Parameter <NR3> Returns the polar radius position.

Example :CURSor:XY:POLar:RADIUS:POSition1?
80.0E-3
Returns the polar radius position as 80.0mV.

:CURSor:XY:POLar:RADIUS:DELta →(Query)

Description Returns the radius delta value of cursor 1 and 2.

Syntax :CURSor:XY:POLar:RADIUS:DELta{?}

Return Parameter <NR3> Returns the radius delta.

Example :CURSor:XY:POLar:RADIUS:DELta?
31.4E-3
Returns the radius delta as 31.4mV.

:CURSor:XY:POLar:THETA:UNIts → Query

Description Query returns the unit of θ in the Polar module in XY mode.

Syntax :CURSor:XY:POLar:THETA:UNIts?

Example :CURSor:XY:POLar:THETA:UNIts?
Query the unit of θ in the Polar module in XY mode

:CURSor:XY:POLar:THETA:POSition<X> → Query

Description Queries the polar angle for the specified cursor in XY mode, where X can be either 1 or 2.

Syntax :CURSor:XY:POLar:THETA:POSition<X>{?}

Parameter <X> 1, 2 (Cursor 1, Cursor 2)

Return parameter <NR3> Returns the polar angle.

Example :CURSor:XY:POLAR:RADIUS:POSition1?
8.91E+1
Returns the polar angle for cursor1 as 89.1°.

:CURSor:XY:POLar:THETA:DELta → Query

Description Queries the polar angle delta between cursor1 and cursor2.

Syntax :CURSor:XY:POLar:THETA:DELta{?}

Return parameter <NR3> Returns the theta delta between cursor1 and cursor2.

Example :CURSor:XY:POLar:THETA:DELta?
 9.10E+0
 Returns the delta as 9.1°.

:CURSor:XY:PRODUct:UNIts → Query

Description Query returns the unit of Product module in XY mode.

Syntax :CURSor:XY:PRODUct:UNIts?

Example :CURSor:XY:PRODUct:UNIts?
 Query the unit of Product module in XY mode.

:CURSor:XY:PRODUct:POSItion<X> → Query

Description Queries the product in XY mode for the specified cursor, where x can be either 1 or 2.

Syntax :CURSor:XY:PRODUct:POSItion<X>{?}

Parameter <X> 1, 2 (Cursor 1, Cursor 2)

Return parameter <NR3> Returns the product value of the Cursor1 or Cursor2.

Example :CURSor:XY:PRODUct:POSItion1?
 9.44E-5
 Returns the product of cursor1 as 94.4uVV.

:CURSor:XY:PRODUct:DELta → Query

Description Queries the product delta in XY mode.

Syntax :CURSor:XY:PRODUct:DELta{?}

Return parameter <NR3> Returns the product delta.

Example :CURSor:XY:PRODUct:DELta?
 1.22E-5
 Returns the product delta as 12.2uVV.

:CURSor:XY:PRODUct:UNIts → Query

Description Query returns the unit of Product module in XY mode.

Syntax :CURSor:XY:PRODUCT:UNIts?

Example :CURSor:XY:PRODUCT:UNIts?
Query the unit of Product module in XY mode

:CURSor:XY:RATio:POSition<X> → Query

Description Queries the ratio in XY mode for the specified cursor, where x can be either cursor 1 or 2.

Syntax :CURSor:XY:RATio:POSition<X>{?}

Parameter <X> 1, 2 (Cursor 1, Cursor 2)

Return parameter <NR3> Returns the ratio.

Example :CURSor:XY:RATio:POSition?
6.717E+1
Returns the ratio value as 6.717V/V.

:CURSor:XY:RATio:UNIts → Query

Description Query returns the unit of Ratio module in XY mode.

Syntax :CURSor:XY:RATio:UNIts?

Example :CURSor:XY:RATio:UNIts?
Query the unit of Ratio module in XY mode.

:CURSor:HTRACking Set →
→ Query

Description Sets or queries the state of horizontal cursor track.

Syntax :CURSor:HTRACking {ON|OFF}
:CURSor:HTRACking?

Example :CURSor:HTRACKing ON
 :CURSor:HTRACKing?
 ON

Set →

→ Query

:CURSor:VTRACKing

Description Sets or queries the state of vertical cursor track.

Syntax :CURSor:VTRACKing {ON|OFF}
 :CURSor:VTRACKing?

Example :CURSor:VTRACKing ON
 :CURSor:VTRACKing?
 ON

:CURSor:XY:RATio:DELta

→ Query

Description Queries the ratio delta in XY mode.

Syntax :CURSor:XY:RATio:DELta{?}

Return parameter <NR3> Returns the ratio delta.

Example :CURSor:XY:RATio:DELta?
 5.39E+1
 Returns the ratio delta as 53.9V/V.

Display Commands

:DISPlay:INTensity:WAVEform Set →
→ Query

Description Sets or queries the waveform intensity level.

Syntax :DISPlay:INTensity:WAVEform {<NRf> | ?}

Parameter <NRf> 0.0E+0 to 1.0E+2 (0% to 100%)

Return Parameter <NR3> Returns the intensity.

Example :DISPlay:INTensity:WAVEform 5.0E+1
Sets the waveform intensity to 50%.

:DISPlay:INTensity:GRATICule Set →
→ Query

Description Sets or queries the graticule intensity level.

Syntax :DISPlay:INTensity:GRATICule {<NRf> | ?}

Parameter <NRf> 1.0E+0 to 1.0E+2 (10% to 100%)

Return Parameter <NR3> Returns the graticule intensity.

Example :DISPlay:INTensity:GRATICule 5.0E+1
Sets the graticule intensity to 50%.

:DISPlay:INTensity:BACKLight Set →
→ Query

Description Sets or queries the intensity of the backlight display.

Syntax :DISPlay:INTensity:BACKLight {<NRf> | ?}

Parameter <NRf> 1.0E+0 to 1.0E+2 (10% to 100%)

Return Parameter <NR3> Returns the backlight intensity.

Example :DISPlay:INTensity:BACKLight 5.0E+1
Sets the backlight intensity to 50%.

:DISPlay:INTENSITy:BACKLight:AUTODim Set →
 :TIMe Query

Description	Sets or queries the display auto-dim time.	
Syntax	:DISPlay:INTENSITy:BACKLight:AUTODim:TIMe { <NR1> OFF ? }	
Parameter/ Return parameter	OFF	Turn off the auto-dim time
	<NR1>	1 ~ 180 minutes. Time in minutes.
Example	:DISPlay:INTENSITy:BACKLight:AUTODim:TIMe 10 Sets the auto-dim time to 10 minutes.	

:DISPlay:PERSSistence Set →
Query

Description	Sets or queries the waveform persistence level.	
Syntax	:DISPlay:PERSSistence { INFINite OFF <NRf> ? }	
Parameter	<NRf>	1.6E-2 ~ 4.0E+0. (16mS to 10S) Range(1.6E-2, 30E-3, 60E-3, 120E-2, 240E-3, 500E-3, 750E-3, 1, 1.5,2,...,9.5,10
	INFINite	Infinite persistence
	OFF	No persistence
Return Parameter	<NR3>	Returns the persistence time.
	INFINite	Infinite persistence
	OFF	No persistence
Example	:DISPlay:PERSSistence 2.0E+0 Sets the persistence to 2 seconds.	

:DISPlay:GRATicule

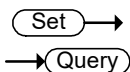

Description	Sets or queries graticule display type.			
Syntax	:DISPlay:GRATicule {FULL GRID CROSSs FRAME ?}			
Parameter	FULL		CROSSs	
	FRAME		GRID	

Return parameter Returns the graticule type.

Example :DISPlay:GRATicule FULL
Sets the graticule to

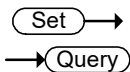

:DISPlay:WAVEform

Description	Sets or queries whether the waveforms are drawn as vectors or dots.	
Syntax	:DISPlay:WAVEform {VECTor DOT ?}	
Parameter	VECTor	Vectors
	DOT	Dots

Return parameter Returns VECTOR or DOT.

Example :DISPlay:WAVEform VECTor
Sets the waveform to vectors.

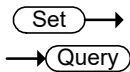

:DISPlay:TRANSREADouts

Description	Sets or queries the state of transparent display.	
Syntax	:DISPlay:TRANSREADouts {ON OFF} :DISPlay:TRANSREADouts?	
Parameter	ON	Turns on the transparent display.

OFF Turns off the transparent display.

Example :DISPlay:TRANSREADouts ON
 :DISPlay:TRANSREADouts?
 ON

:DISPlay:WAVEform:COLor

Set →

→ Query

Description Sets or queries the waveform color display format.

Syntax :DISPlay:WAVEform:COLor {GRAYscale | COLor | ?}

Parameter **GRAYscale** Sets waveform display as grayscale
COLor Sets waveform display as color

Return parameter Returns GRAYscale or COLor.

Example :DISPlay:WAVEform:COLor GRAYscale
 Sets the waveform to grayscale.

Measure Commands

:MEASure:GATing



Description	Sets or queries the measurement gating.	
Syntax	:MEASure:GATing { OFF SCREEn CURSor ? }	
Parameter	OFF	Full record
	SCREEn	Gating set to screen width
	CURSor	Gating between cursors
Return parameter	Returns the gating. (OFF, SCREEN, CURSOR)	
Example	:MEASure:GATing OFF Turns gating off (full record).	

:MEASure:SOURce



Description	Sets or queries the measurement source for source1 or source2.	
Syntax	:MEASure:SOURce<X> { CH1 CH2 CH3 CH4 ? }	
Parameter	<X>	Source1 or source2
	CH1~CH4	Channel 1 to 4
Return parameter	Returns the source (CH1, CH2, CH3, CH4)	
Example	:MEASure:SOURce1 CH1 Sets source1 to channel 1.	

:MEASure:METHod



Description	Sets or queries the method used to determine the High-Low measurement values.	
Syntax	:MEASure:METHod { AUTo HIStogram MINMax ? }	

Parameter	AUTO	Set to auto.
	HISTogram	Set to the Histogram method.
	MINMax	Set to the Min-Max method.

Return parameter Returns the measurement method (AUTO, HISTOGRAM, MINMAX)

Example :MEASure:METHOD: AUTO
Set the measurement method to auto.

(Set) →

:MEASUrement:REFLevel:PERCent:HIGH → (Query)

Description Sets or queries the high reference level as a percentage.

Syntax :MEASUrement:REFLevel:PERCent:HIGH {<NRf> | ?}

Parameter	<NRf>	0 - 100%
-----------	-------	----------

Return parameter Returns the high reference level

Example :MEASUrement:REFLevel:PERCent:HIGH 50.1
Set the high reference level to 50.1%.

(Set) →

:MEASUrement:REFLevel:PERCent:LOW → (Query)

Description Sets or queries the low reference level as a percentage.

Syntax :MEASUrement:REFLevel:PERCent:LOW {<NRf> | ?}

Parameter	<NRf>	0 - 100%
-----------	-------	----------

Return parameter Returns the low reference level.

Example :MEASUrement:REFLevel:PERCent:LOW 40.1
Set the low reference level to 40.1%.

:MEASUrement:REFLevel:PERCent:MID
 →
 → 

Description	Sets or queries the first mid reference level as a percentage.
Syntax	:MEASUrement:REFLevel:PERCent:MID {<Nrf> ?}
Parameter	<Nrf> 0 - 100%
Return parameter	Returns the mid reference level.
Example	:MEASUrement:REFLevel:PERCent:MID 50 Set the mid reference level to 50%.

:MEASure:FALL → 

Description	Returns the fall time measurement result.
Syntax	:MEASure:FALL{?}
Related Commands	:MEASure:SOURce<X>
Return parameter	<NR3> Chan Off Indicates the source channel is not activated.

 **Note** Before using this command, select the measurement channel. See the example below.

Example :MEASure:SOURce1 CH1
:MEASure:FALL?
Selects Channel 1 as the source, and then measures the fall time.

:MEASure:FREQuency

→ Query

Description	Returns the frequency value.				
Syntax	:MEASure:FREQuency{?}				
Related Commands	:MEASure:SOURce<X>				
Return parameter	<table border="0"> <tr> <td><NR3></td> <td>Returns the frequency in Hz.</td> </tr> <tr> <td>Chan Off</td> <td>Indicates the source channel is not activated.</td> </tr> </table>	<NR3>	Returns the frequency in Hz.	Chan Off	Indicates the source channel is not activated.
<NR3>	Returns the frequency in Hz.				
Chan Off	Indicates the source channel is not activated.				



Note

Before using this command, select the measurement channel. See the example below.

Example	<pre>:MEASure:SOURce1 CH1 :MEASure:FREQuency? >1.0E+3</pre> <p>Selects Channel 1, and then measures the frequency.</p>
---------	---

:MEASure:NWIDth

→ Query

Description	Returns the first negative pulse width timing.				
Syntax	:MEASure:NWIDth{?}				
Related Commands	:MEASure:SOURce<X>				
Return parameter	<table border="0"> <tr> <td><NR3></td> <td>Returns the negative pulse width in seconds.</td> </tr> <tr> <td>Chan Off</td> <td>Indicates the source channel is not activated.</td> </tr> </table>	<NR3>	Returns the negative pulse width in seconds.	Chan Off	Indicates the source channel is not activated.
<NR3>	Returns the negative pulse width in seconds.				
Chan Off	Indicates the source channel is not activated.				



Note

Before using this command, select the measurement channel. See the example below.

Example	<pre>:MEASure:SOURce1 CH1 :MEASure:NWIDth? 4.995E-04</pre>
---------	--

Selects Channel 1, and then measures the negative pulse width.

:MEASure:PDUTy

→ Query

Description	Returns the positive duty cycle ratio as percentage.	
Syntax	:MEASure:PDUTy{?}	
Related commands	:MEASure:SOURce<X>	
Return parameter	<NR3>	Returns the positive duty ratio.
	Chan Off	Indicates the source channel is not activated.

 **Note** Before using this command, select the measurement channel. See the example below.

Example

```
:MEASure:SOURce1 CH1
:MEASure:PDUTy?
5.000E+01
```

Selects Channel 1, and then measures the positive duty cycle.

:MEASure:PERiod

→ Query

Description	Returns the period.	
Syntax	:MEASure:PERiod{?}	
Related Commands	:MEASure:SOURce<X>	
Return parameter	<NR3>	Returns the period.
	Chan Off	Indicates the source channel is not activated.

 **Note** Before using this command, select the measurement channel. See the example below.

Example :MEASure:SOURce1 CH1
 :MEASure:PERiod?
 1.0E-3
 Selects Channel 1, and then measures the period.

:MEASure:PWIDth → Query

Description	Returns the first positive pulse width.	
Syntax	:MEASure:PWIDth{?}	
Related Commands	:MEASure:SOURce<X>	
Return parameter	<NR3>	Returns the positive pulse width.
	Chan Off	Indicates the source channel is not activated.

 **Note** Before using this command, select the measurement channel. See the example below.

Example :MEASure:SOURce1 CH1
 :MEASure:PWIDth?
 5.0E-6
 Selects Channel 1, and then measures the positive pulse width.

:MEASure:RISe → Query

Description	Returns the first pulse rise time.	
Syntax	:MEASure:RISe{?}	
Related Commands	:MEASure:SOURce<X>	
Return parameter	<NR3>	Returns the rise time.
	Chan Off	Indicates the source channel is not activated.

 **Note** Before using this command, select the measurement channel. See the example below.

Example :MEASure:SOURce1 CH1
 :MEASure:RISe?
 8.5E-6
 Selects Channel 1, and then measures the rise time.

:MEASure:ROVShoot → Query

Description Returns the rising overshoot over the entire waveform in percentage.

Syntax :MEASure:ROVShoot{?}

Related Commands :MEASure:SOURce<X>

Return parameter	<NR3>	Returns the overshoot.
	Chan Off	Indicates the source channel is not activated.

 **Note** Before using this command, select the measurement channel. See the example below.

Example :MEASure:SOURce1 CH1
 :MEASure:ROVShoot?
 5.00E+00
 Selects Channel 1, and then measures the rise overshoot.

:MEASure:RPReshoot → Query

Description Returns rising preshoot over the entire waveform in percentage.

Syntax :MEASure:RPReshoot{?}

Related Commands :MEASure:SOURce<X>

Return parameter	<NR3>	Returns the rising preshoot.
------------------	-------	------------------------------

Chan Off	Indicates the source channel is not activated.
----------	--



Note

Before using this command, select the measurement channel. See the example below.

Example

```
:MEASure:SOURce1 CH1
:MEASure:RPReshoot?
2.13E-2
```

Selects Channel 1, and then measures the rise preshoot.

:MEASure:PPULSE



Description

Returns the number of positive pulses.

Syntax

```
:MEASure:PPULSE{?}
```

Related Commands

```
:MEASure:SOURce<X>
```

Return parameter

<NR3>	Returns the number of positive pulses.
Chan Off	Indicates the source channel is not activated.



Note

Before using this command, select the measurement channel. See the example below.

Example

```
:MEASure:SOURce1 CH1
:MEASure:PPULSE?
6.000E+00
```

Selects Channel 1, and then measures the number of positive pulses.

:MEASure:NPULSE

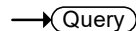

Description

Returns the number of negative pulses.

Syntax

```
:MEASure:NPULSE{?}
```

Related Commands

```
:MEASure:SOURce<X>
```

Return parameter	<NR3>	Returns the number of negative pulses.
	Chan Off	Indicates the source channel is not activated.

 **Note** Before using this command, select the measurement channel. See the example below.

Example :MEASure:SOURce1 CH1
 :MEASure:NPULSE?
 4.000E+00
 Selects Channel 1, and then measures the number of negative pulses.

:MEASure:PEDGE → 

Description	Returns the number of positive edges.	
Syntax	:MEASure:PEDGE{?}	
Related Commands	:MEASure:SOURce<X>	
Return parameter	<NR3>	Returns the number of positive edges.
	Chan Off	Indicates the source channel is not activated.

 **Note** Before using this command, select the measurement channel. See the example below.

Example :MEASure:SOURce1 CH1
 :MEASure:PEDGE?
 1.100E+01
 Selects Channel 1, and then measures the number of positive edges.

:MEASure:NEDGE → 

Description	Returns the number of negative edges.	
Syntax	:MEASure:NEDGE{?}	

Related Commands :MEASure:SOURce<X>

Return parameter	<NR3>	Returns the number of negative edges.
	Chan Off	Indicates the source channel is not activated.

 **Note** Before using this command, select the measurement channel. See the example below.

Example :MEASure:SOURce1 CH1
 :MEASure:NEDGE?
 1.100E+01
 Selects Channel 1, and then measures the number of negative edges.

:MEASure:AMPlitude → **Query**

Description Returns the amplitude difference between the Vhigh-Vlow.

Syntax :MEASure:AMPlitude{?}

Related Commands :MEASure:SOURce<X>

Return parameter	<NR3>	Returns the amplitude.
	Chan Off	Indicates the source channel is not activated.

 **Note** Before using this command, select the measurement channel. See the example below.

Example :MEASure:SOURce1 CH1
 :MEASure:AMPlitude?
 3.76E-3
 Selects Channel 1, and then measures the amplitude.

:MEASure:MEAN

→ **Query**

Description Returns the mean voltage/current of one or more full periods.

Syntax :MEASure:MEAN{??}

Related Commands :MEASure:SOURce<X>

Return parameter	<NR3>	Returns the mean.
	Chan Off	Indicates the source channel is not activated.

 **Note** Before using this command, select the measurement channel. See the example below.

Example :MEASure:SOURce1 CH1
 :MEASure:MEAN?
 1.82E-3
 Selects Channel 1, and then measures the mean value.

:MEASure:CMEan

→ **Query**

Description Returns the mean voltage/current of one full period.

Syntax :MEASure:CMEan{??}

Related Commands :MEASure:SOURce<X>

Return parameter	<NR3>	Returns the cyclic mean.
	Chan Off	Indicates the source channel is not activated.

 **Note** Before using this command, select the measurement channel. See the example below.

Example :MEASure:SOURce1 CH1
 :MEASure:CMEan?
 9.480E-01
 Selects Channel 1, and then measures the mean value of the first period.

:MEASure:HIGH → Query

Description	Returns the global high voltage/current.	
Syntax	:MEASure:HIGH{?}	
Related Commands	:MEASure:SOURce<X>	
Return parameter	<NR3>	Returns the high value.
	Chan Off	Indicates the source channel is not activated.

 **Note** Before using this command, select the measurement channel. See the example below.

Example :MEASure:SOURce1 CH1
 :MEASure:HIGH?
 3.68E-3
 Selects Channel 1, and then measures the high voltage/current.

:MEASure:LOW → Query

Description	Returns the global low voltage/current.	
Syntax	:MEASure:LOW{?}	
Related Commands	:MEASure:SOURce<X>	
Return parameter	<NR3>	Returns the global low value.
	Chan Off	Indicates the source channel is not activated.



Before using this command, select the measurement channel. See the example below.

Example

```
:MEASure:SOURce1 CH1
```

```
:MEASure:LOW?
```

```
1.00E-0
```

Selects Channel 1, and then measures the low current/voltage.

:MEASure:MAX

→ Query

Description	Returns the maximum amplitude.	
Syntax	:MEASure:MAX{?}	
Related Commands	:MEASure:SOURce<X>	
Return parameter	<NR3>	Returns the maximum amplitude.
	Chan Off	Indicates the source channel is not activated.



Note

Before using this command, select the measurement channel. See the example below.

Example	:MEASure:SOURce1 CH1 :MEASure:MAX? 1.90E-3
	Selects Channel 1, and then measures the maximum amplitude.

:MEASure:MIN

→ Query

Description	Returns the minimum amplitude.	
Syntax	:MEASure:MIN{?}	
Related Commands	:MEASure:SOURce<X>	
Return parameter	<NR3>	Returns the minimum amplitude.
	Chan Off	Indicates the source channel is not activated.



Note

Before using this command, select the measurement channel. See the example below.

Example	:MEASure:SOURce1 CH1 :MEASure:MIN? -8.00E-3
---------	---

Selects Channel 1, and then measures the minimum amplitude.

:MEASure:PK2PK → Query

Description	Returns the peak-to-peak amplitude (difference between maximum and minimum amplitude).	
Syntax	:MEASure:PK2Pk{?}	
Related Commands	:MEASure:SOURce<X>	
Return parameter	<NR3>	Returns the voltage or current peak to peak measurement.
	Chan Off	Indicates the source channel is not activated.

 **Note** Before using this command, select the measurement channel. See the example below.

Example

```
:MEASure:SOURce1 CH1
:MEASure:PK2Pk?
2.04E-1
```

Selects Channel 1, and then measures the peak-to-peak amplitude.

:MEASure:RMS → Query

Description	Returns the root-mean-square voltage/current of one or more full periods.	
Syntax	:MEASure:RMS{?}	
Related Commands	:MEASure:SOURce<X>	
Return parameter	<NR3>	Returns the RMS value.
	Chan Off	Indicates the source channel is not activated.



Note

Before using this command, select the measurement channel. See the example below.

Example

```
:MEASure:SOURce1 CH1
```

```
:MEASure:RMS?
```

```
1.31E-3
```

Selects Channel 1, and then measures the RMS voltage/current.

:MEASure:CRMS



Description

Returns the root-mean-square voltage/current of one full periods.

Syntax

```
:MEASure:CRMS{?}
```

Related

```
:MEASure:SOURce<X>
```

Commands

Return parameter

<NR3>

Returns the CRMS value.

Chan Off

Indicates the source channel is not activated.



Note

Before using this command, select the measurement channel. See the example below.

Example

```
:MEASure:SOURce1 CH1
```

```
:MEASure:CRMS?
```

```
1.31E-3
```

Selects Channel 1, and then measures the CRMS voltage/current.

:MEASure:AREa

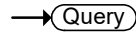

Description

Returns the voltage/current area over one or more full periods.

Syntax

```
:MEASure:AREa{?}
```

Related

```
:MEASure:SOURce<X>
```

Commands

Return parameter	<NR3>	Returns the area value.
	Chan Off	Indicates the source channel is not activated.

 **Note** Before using this command, select the measurement channel. See the example below.

Example :MEASure:SOURce1 CH1
 :MEASure:AREa?
 1.958E-03
 Selects Channel 1, and then measures the area.

:MEASure:CARea → **Query**

Description Returns the voltage/current area over one full period.

Syntax :MEASure:CARea{?}

Related Commands :MEASure:SOURce<X>

Return parameter	<NR3>	Returns the area value.
	Chan Off	Indicates the source channel is not activated.

 **Note** Before using this command, select the measurement channel. See the example below.

Example :MEASure:SOURce1 CH1
 :MEASure:CARea?
 1.958E-03
 Selects Channel 1, and then measures the area.

:MEASure:FRRDelay → **Query**

Description Returns the delay between the first rising edge of source1 and the first rising edge of source2.

Syntax :MEASure:FRRDelay{?}

Related Commands :MEASure:SOURce<X>

Return parameter	<NR3>	Returns the delay.
	Chan Off	Indicates the source channel is not activated.

 **Note** Select the two source channels before entering this command.

Example :MEASure:SOURce1 CH1
 :MEASure:SOURce2 CH2
 :MEASure:FRRDelay?
 -4.68E-6
 Select channel 1 and 2 as source1/2, and then measure FRR.

:MEASure:FRFDelay → Query

Description Returns the delay between the first rising edge of source1 and the first falling edge of source2.

Syntax :MEASure:FRFDelay{?}

Related Commands :MEASure:SOURce<X>

Return parameter	<NR3>	Returns the delay.
	Chan Off	Indicates the source channel is not activated.

 **Note** Select the two source channels before entering this command.

Example :MEASure:SOURce1 CH1
 :MEASure:SOURce2 CH2
 :MEASure:FRFDelay?
 3.43E-6
 Select channel 1 and 2 as source1/2, and then measures FRF.

:MEASure:FRRDelay → Query

Description Returns the delay between the first falling edge of source1 and the first rising edge of source2.

Syntax :MEASure:FRRDelay{?}

Related Commands :MEASure:SOURce<X>

Return parameter	<NR3>	Returns the delay.
	Chan Off	Indicates the source channel is not activated.

 **Note** Select the two source channels before entering this command.

Example

```
:MEASure:SOURce1 CH1
:MEASure:SOURce2 CH2
:MEASure:FRRDelay?
-8.56E-6
```

Select channel 1 and 2 as delay source1/2, and then measure FFR.

:MEASure:FFFDelay → Query

Description Returns the delay between the first falling edge of source1 and the first falling edge of source2.

Syntax :MEASure:FFFDelay{?}

Related Commands :MEASure:SOURce<X>

Return parameter	<NR3>	Returns the delay.
	Chan Off	Indicates the source channel is not activated.

 **Note** Select the two source channels before entering this command.

Example :MEASure:SOURce1 CH1
 :MEASure:SOURce2 CH2
 :MEASure:FFFDelay?
 -8.89E-6
 Select channel 1 and 2 as delay source1/2, and then measure FFF.

:MEASure:LRRDelay → Query

Description Returns the delay between the first rising edge of source1 and the last rising edge of source2.

Syntax :MEASure:LRRDelay{?}

Related Commands :MEASure:SOURce<X>

Return parameter <NR3> Returns the delay.

Chan Off Indicates the source channel is not activated.

 Note Select the two source channels before entering this command.

Example :MEASure:SOURce1 CH1
 :MEASure:SOURce2 CH2
 :MEASure:LRRDelay?
 -8.89E-6
 Select channel 1 and 2 as delay source1/2, and then measure LRR.

:MEASure:LRFDelay → Query

Description Returns the delay between the first rising edge of source1 and the last rising edge of source2.

Syntax :MEASure:LRFDelay{?}

Related Commands :MEASure:SOURce<X>

Return parameter	<NR3>	Returns the delay.
	Chan Off	Indicates the source channel is not activated.

 **Note** Select the two source channels before entering this command.

Example

```
:MEASure:SOURce1 CH1
:MEASure:SOURce2 CH2
:MEASure:LRFDelay?
-4.99E-6
```

Select channel 1 and 2 as delay source1/2, and then measure LRF.

:MEASure:LFRDelay

→ Query

Description	Returns the delay between the first falling edge of source1 and the last rising edge of source2.	
Syntax	:MEASure:LFRDelay{?}	
Related Commands	:MEASure:SOURce<X>	
Return parameter	<NR3>	Returns the delay.
	Chan Off	Indicates the source channel is not activated.
 Note	Select the two source channels before entering this command.	
Example	:MEASure:SOURce1 CH1 :MEASure:SOURce2 CH2 :MEASure:LFRDelay? -9.99E-6 Select channel 1 and 2 as delay source1/2, and then measure LFR.	

:MEASure:LFFDelay

→ Query

Description	Returns the delay between the first falling edge of source1 and the last falling edge of source2.	
Syntax	:MEASure:LFFDelay{?}	
Related Commands	:MEASure:SOURce<X>	
Return parameter	<NR3>	Returns the delay.
	Chan Off	Indicates the source channel is not activated.
 Note	Select the two source channels before entering this command.	

Example :MEASure:SOURce1 CH1
 :MEASure:SOURce2 CH2
 :MEASure:LFFDelay?
 -9.99E-6
 Select channel 1 and 2 as delay source1/2, and
 then measure LFF.



:MEASure:PHAsE → Query



Description	Returns the phase between source 1 and source 2.	
Syntax	:MEASure:PHAsE{?}	
Related Commands	:MEASure:SOURce<X>	
Return parameter	<NR3>	Returns the phase difference.
	Chan Off	Indicates the source channel is not activated.

 **Note** Select the two source channels before entering this command.

Example :MEASure:SOURce1 CH1
 :MEASure:SOURce2 CH2
 :MEASure:PHAsE?
 4.50E+01
 Select channel 1 and 2 as phase source1/2, and
 then measure the phase in degrees.

Measurement Commands

		
:MEASUrement:MEAS<X>:SOURCE<X>		
Description	Sets or queries the measurement source for a selected automatic measurement. This is a statistics related command.	
Syntax	:MEASUrement:MEAS<X>:SOURCE<X> { CH1 CH2 CH3 CH4 ? }	
Related commands	:MEASUrement:MEAS<X>:TYPE	
Parameter	MEAS<X>	The automatic measurement number from 1 to 8.
	SOURCE<X>	SOURCE1: the source for all single channel measurements.
	SOURCE<X>	SOURCE2: the source for all delay or phase measurements.
	CH1 to CH4	Channel 1, 2, 3, 4
Return parameter	CH1 to CH4	Channel 1, 2, 3, 4
Example	:MEASUrement:MEAS1:SOURCE1? >CH1 Returns the (first) source for measurement 1.	

		
:MEASUrement:MEAS<X>:DELAY		
Description	Query measurement parameters for the specified index delay measurement.	
Syntax	MEASUrement:MEAS1:DELAY?	
Parameter	<X>	Range is 1-8.

Example MEASUrement:MEAS1:DElAy?
 Query measurement parameters for the specified
 index 1 delay measurement

(Set) →

:MEASUrement:MEAS<X>:DElAy:DIRectiOn → (Query)

Description Query or set the direction of the delay
 measurement for the specified index.

Syntax :MEASUrement:MEAS<x>:DElAy:DIRectiOn
 {BACKWards|FORWards}
 :MEASUrement:MEAS<x>:DElAy:DIRectiOn?

Parameter	BACKWards	Searching from the end of the waveform and looking for the last rising or falling edge within the waveform. Use the: MEAS<x>:DElAy:EDGE<x> command to specify.
	FORWards	Searching from the beginning of the waveform, looking for the first rising or falling edge within the waveform. Use the: MEAS<x>:DElAy:EDGE<x> command to specify.

Example :MEASUrement:MEAS1:DElAy:DIRectiOn FORWards
 Set the direction setting of delay measurement for
 the specified number 1 to FORWards.

(Set) →

:MEASUrement:MEAS<X>:DElAy:EDGE<x> → (Query)

Description Query or set the edge type for the specified
 sequence number delay measurement.

Syntax :MEASUrement:MEAS<x>:DElAy:EDGE<x>
 {FALL|RISe}
 :MEASUrement:MEAS<x>:DElAy:EDGE<x>?

Parameter FALL

RISe	
X	Range of 1-2. 1 indicates from waveform; 2 indicates to waveform.

Example :MEASUrement:MEAS1:DELay:EDGE1 RISe
 Set the edge type of the delay measurement for the specified number 1 to RISe.

:MEASUrement:MEAS<X>:TYPE (Set) →
→ (Query)

Description Sets or queries the measurement type for a selected automatic measurement. This is a statistics related command.

Syntax :MEASUrement:MEAS<X>:TYPE
 {PK2pk | MAXimum | MINIMUM | AMPLitude | HIGH | LOW | MEAN | CMEan | RMS | CRM s | AREa | CAREa | ROVShoot | FOVShoot | RPReshoot | FPReshoot | FREQuency | PERIod | RISe | FALL | PWIdth | NWIdth | PDUTy | NDU Ty | PPULSE | NPULSE | PEDGE | NEDGE | FRRDelay | FRFDelay | FFRDelay | FFFDelay | LRRDelay | LRFDelay | LFRDelay | LFFDelay | PHASE | ?}

Related commands :MEASUrement:MEAS<X>:SOURCE<X>

Parameter	MEAS<X>	The automatic measurement number from 1 to 8.
-----------	---------	---

Return parameter Returns the measurement type

Example :MEASUrement:MEAS1:TYPE RMS
 Sets measurement 1 to RMS measurement.

:MEASUrement:MEAS<X>:STATE (Set) →
→ (Query)

Description Sets or queries the state of a selected measurement. This is a statistics related command.

Syntax :MEASUrement:MEAS<X>:STATE { ON | OFF | 1 | 0 | ? }

Related commands	:MEASUrement:MEAS<X>:SOURce<X> :MEASUrement:MEAS<X>:TYPE	
Parameter	MEAS<X>	The automatic measurement number from 1 to 8.
	ON/1	Turn the measurement on.
	OFF/0	Turn the measurement off.
Return parameter	0	Measurement is off.
	1	Measurement is on.
Example	:MEASUrement:MEAS1:STATE 1 Turns measurement 1 on.	

:MEASUrement:MEAS<X>:VALue → Query

Description	Returns the measurement results for the selected measurement. This is a statistics related command.	
Syntax	:MEASUrement:MEAS<X>:VALue?	
Related Commands	:MEASure:SOURce<X>	
Parameter	MEAS<X>	The automatic measurement number from 1 to 8.
	<NR3>	Returns the measurement for the selected measurement number.

 **Note** The measurement source(s), measurement number, measurement type and measurement state must first be set before a measurement result can be returned.

Example

```
:MEASUrement:MEAS1:SOURce1 CH1
:MEASUrement:MEAS1:TYPE PK2PK
:MEASUrement:MEAS1:STATE ON
:MEASUrement:MEAS1:VALue?
5.000E+0
```

Selects channel 1 as the source for measurement 1, sets measurement 1 to peak to peak measurement

and then turns on the measurement. The result returns the peak to peak measurement.

:MEASUrement:MEAS<X>:MAXimum → Query

Description Returns the maximum measurement results for the selected measurement from the last time the statistics were reset. This is a statistics related command.

Syntax :MEASUrement:MEAS<X>:MAXimum?

Related Commands :MEASUrement:STATIstics:MODE

Parameter	MEAS<X>	The automatic measurement number from 1 to 8.
------------------	---------	---

Return parameter	<NR3>	Returns the measurement for the selected measurement number.
-------------------------	-------	--

Example

```
:MEASUrement:MEAS3:SOUrce1 CH1
:MEASUrement:MEAS3:TYPe PK2PK
:MEASUrement:MEAS3:STATE ON
:MEASUrement:STATIstics:MODE ON
:MEASUrement:MEAS3:MAXimum?
2.800E-02
```

Returns the maximum measurement result for measurement number 3.

:MEASUrement:MEAS<X>:MEAN → Query

Description Returns the mean measurement results for the selected measurement from the last time the statistics were reset. This is a statistics related command.

Syntax :MEASUrement:MEAS<X>:MEAN?

Related Commands :MEASUrement:STATIstics:MODE

Parameter	MEAS<X>	The automatic measurement number from 1 to 8.
Return parameter	<NR3>	Returns the measurement for the selected measurement number.
Example	<pre>:MEASUrement:MEAS3:SOUrce1 CH1 :MEASUrement:MEAS3:TYPe PK2PK :MEASUrement:MEAS3:STATE ON :MEASUrement:STATIstics:MODE ON :MEASUrement:MEAS3:MEAN? 2.090E-02</pre> <p>Returns the mean measurement result for measurement number 3.</p>	

:MEASUrement:MEAS<X>:MINImum → Query

Description	Returns the minimum measurement results for the selected measurement from the last time the statistics were reset. This is a statistics related command.	
Syntax	:MEASUrement:MEAS<X>:MINImum?	
Related Commands	:MEASUrement:STATIstics:MODE	
Parameter	MEAS<X>	The automatic measurement number from 1 to 8.
Return parameter	<NR3>	Returns the measurement for the selected measurement number.
Example	<pre>:MEASUrement:MEAS3:SOUrce1 CH1 :MEASUrement:MEAS3:TYPe PK2PK :MEASUrement:MEAS3:STATE ON :MEASUrement:STATIstics:MODE ON :MEASUrement:MEAS3:MINImum? 1.600E-02</pre>	

Returns the minimum measurement result for measurement number 3.

:MEASUrement:MEAS<X>:STDdev →(Query)

Description Returns the standard deviation for the selected measurement from the last time the statistics were reset. This is a statistics related command.

Syntax :MEASUrement:MEAS<X>:STDdev?

Related Commands :MEASUrement:STATIstics:MODE

Parameter	MEAS<X>	The automatic measurement number from 1 to 8.
------------------	---------	---

Return parameter	<NR3>	Returns the measurement for the selected measurement number.
-------------------------	-------	--

Example

```
:MEASUrement:MEAS3:SOUrce1 CH1
:MEASUrement:MEAS3:TYPe PK2PK
:MEASUrement:MEAS3:STATE ON
:MEASUrement:STATIstics:MODE ON
:MEASUrement:MEAS3:STDdev?
1.530E-03
```

Returns the standard deviation for measurement number 3.

:MEASUrement:MEAS<X>:UNIIts →(Query)

Description Query unit of measurement for specified sequence number.

Syntax :MEASUrement:MEAS<X>:UNIIts

Parameter	X	Range from 1 to 8.
------------------	---	--------------------

Example

```
:MEASUrement:MEAS1:UNIIts?
Query unit of measurement for specified sequence number 1
```

:MEASUREMENT:STATISTICS:MODE (Set) →
→ (Query)

Description	Puts the statics measurement results on the display or queries whether the statistics are displayed.	
Syntax	:MEASUREMENT:STATISTICS:MODE {OFF ON ?}	
Related commands	:MEASUREMENT:STATISTICS	
Parameter/Return parameter	ON	Display the statistics on the screen.
	OFF	Remove the statistics from the screen
Example	:MEASUREMENT:STATISTICS:MODE ON Displays statistics on the screen.	

:MEASUREMENT:STATISTICS:WEIGHTING (Set) →
→ (Query)

Description	Sets and queries the number of samples (weighting) used for the statistics calculations.	
Syntax	:MEASUREMENT:STATISTICS:WEIGHTING { <NR1> ? }	
Parameter/Return parameter	<NR1>	Number of samples (2~1000)
Example	:MEASUREMENT:STATISTICS:WEIGHTING 5 Sets the number of samples to 5.	

:MEASUREMENT:INDICATORS:STAT (Set) →
→ (Query)

Description	Set or query the measurement indicator's state.	
Syntax	:MEASUREMENT:INDICATORS:STAT {OFF MEAS<x>} :MEASUREMENT:INDICATORS:STAT?	
Parameter	OFF	Turn off the indicator.
	MEAS<x>	Set the indicator source. <x>:1~8.

```
Example      :MEASUrement:INDICators:STAT OFF
              :MEASUrement:INDICators:STAT?
              OFF
              :MEASUrement:INDICators:STAT MEAS2
              :MEASUrement:INDICators:STAT?
              MEAS2
```

:MEASUrement:INDICators:HORIZ<x>? → Query

Description	Query the position of measurement indicator's horizontal track.	
Syntax	:MEASUrement:INDICators:HORIZ<x>? {PRECise}	
Parameter	HORIZ<x>	The horizontal track. <x>:1 or 2.
	PRECise	Display more digit for the return value.

```
Example      :MEASUrement:INDICators:HORIZ1?
              3.120e+00
              :MEASUrement:INDICators:HORIZ1? PRECise
              3.120000e+00
```

:MEASUrement:INDICators:VERT<x>? → Query

Description	Query the position of measurement indicator's vertical track.	
Syntax	:MEASUrement:INDICators:VERT<x>? {PRECise}	
Parameter	VERT<x>	The vertical track. <x>:1 or 2.
	PRECise	Display more digit for the return value.

```
Example      :MEASUrement:INDICators:VERT1?
              -2.135e-02
              :MEASUrement:INDICators:VERT1? PRECise
              -2.135000e-02
```

:MEASUREMENT:INDICATORS:NUMHORZ? → Query

Description Query the number of measurement indicator's horizontal tracks currently being displayed.

Syntax :MEASUREMENT:INDICATORS:NUMHORZ?

Example :MEASUREMENT:INDICATORS:NUMHORZ?
2

:MEASUREMENT:INDICATORS:NUMVERT? → Query

Description Query the number of measurement indicator's vertical tracks currently being displayed.

Syntax :MEASUREMENT:INDICATORS:NUMVERT?

Example :MEASUREMENT:INDICATORS:NUMVERT?
1

:MEASUREMENT:STATISTICS Set →

Description Resets the statics calculations. This command will clear all the currently accumulated measurements.

Syntax :MEASUREMENT:STATISTICS {RESET}

Reference Commands

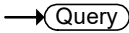
		
:REF<X>:DISPlay		
Description	Sets or queries whether a reference waveform will be shown on the display. A reference waveform must first be saved before this command can be used.	
Syntax	:REF<x>:DISPlay { OFF ON ? }	
Parameter	<X>	Reference waveform 1, 2, 3, 4.
	OFF	Turns the selected reference waveform off
	ON	Turns the selected reference waveform on
Return parameter	Returns the status of the selected reference waveform. (OFF, ON).	
Example	:REF1:DISPlay ON Turns on reference1 (REF 1) on the display.	

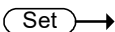
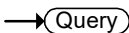
		
:REF<X>:OFFSet		
Description	Sets or returns the selected reference waveform vertical position (offset).	
Syntax	:REF<X>:OFFSet { <NRf> ? }	
Related commands	:REF<X>:DISPlay	
Parameter	<X>	Reference waveform 1, 2, 3, 4.
	<NRf>	Vertical offset
Return parameter	<NR3>	Returns the reference waveform vertical position.

Example :REF1:OFFSet -5.000E-2
 Selects reference 1, and then sets the vertical position to -50mV/mA.

:REF<x>:SCALE  

Description Sets or returns the selected reference waveform vertical scale.

Syntax :REF<X>:SCALE { <NRf> | ? }

Related commands :REF<X>:DISPlay

Parameter	<X>	Reference waveform 1, 2, 3, 4.
	<NRf>	Vertical scale

Return parameter	<NR3>	Returns the reference waveform vertical scale.
------------------	-------	--

Example :REF1:SCALE 5.000E-2
 Selects reference 1, and then sets the vertical scale to 50mV | mA/div.

:REF:STATe  

Description Enable or disable the reference waveform function.

Syntax :REF:STATe { OFF | ON | ? }

Parameter	OFF	Disable the Reference waveform function.
	ON	Enable the Reference waveform function

Return parameter Returns the status of the reference waveform.

Example :REF:STATe ON
 Enable the reference waveform function.

Run Command

:RUN



Description The run command allows the oscilloscope to continuously make acquisitions (equivalent to pressing the Run key on the front panel).

Syntax :RUN

Stop Command

:STOP

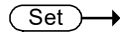

Description The stop command stops the oscilloscope making further acquisitions (equivalent to pressing the Stop key on the front panel).

Syntax :STOP

Force Command

:FORCE



Description The Force command forces an acquisition (equivalent to pressing the Force-Trig key on the front panel).

Syntax :FORCE

Timebase Commands

:TIMebase:EXPand (Set) →
→ (Query)

Description Sets or queries the horizontal expansion mode.

Syntax :TIMebase:EXPand {CENTer|TRIGger|?}

Parameter/Return parameter	CENTer	Expand from the center of the display.
	TRIGger	Expand from the trigger point.

Example :TIMebase:EXPand TRIGger
Sets the expansion point to the trigger point.

:TIMebase:SCALE (Set) →
→ (Query)

Description Sets or queries the horizontal scale.

Syntax :TIMebase:SCALE {<NRf> | ?}

Parameter <NRf> Horizontal scale

Return parameter <NR3> Returns the horizontal scale.

Example :TIMebase:SCALE 5.00E-2
Sets the horizontal scale to 50ms/div.

:TIMebase:MODE (Set) →
→ (Query)

Description Sets or queries the time base mode. The time base mode determines the display view window on the scope.

Syntax :TIMebase:MODE {MAIN | WINDow | XY | ?}

Parameter	MAIN	Sets the time base mode to the main screen.
------------------	------	---

WINDow	Sets the time base mode to the zoom window.
XY	Sets the time base mode to the XY display.

Return parameter Returns the time base mode (MAIN, WINDOW, XY)

Example :TIMebase:MODE MAIN
Sets the time base mode to the main mode.

:TIMebase:WINDow:POSition (Set) →
← (Query)

Description Sets or queries the zoom horizontal position.

Syntax :TIMebase:WINDow:POSition {<NRf> | ?}

Related commands :TIMebase:MODE

Parameter <NRf> Horizontal position for zoom window

Return parameter <NR3> Returns the zoom horizontal position.

Example :TIMebase:WINDow:POSition 2.0E-3
Sets the zoom horizontal position as 20ms.

:PLAYStop (Set) →

Description Set the zoom play/stop or play the current segment in segments mode.

Syntax :PLAYStop {ON|OFF}
:PLAYStop?

Parameter	ON	Play
	OFF	Stop

Example :PLAYStop ON
:PLAYStop?
ON

:TIMebase:WINDow:SCALE



Description	Sets or queries the zoom horizontal scale.	
Note	If the oscilloscope is under “ZOOM” mode, the main timebase function will be disabled and cannot be modified.	
Syntax	:TIMebase:WINDow:SCALE {<NRf> ?}	
Related commands	:TIMebase:MODE	
Parameter	<NRf>	Zoom horizontal scale. The range will depend on the time base.
Return parameter	<NR3>	Returns the zoom horizontal scale.
Example	:TIMebase:WINDow:SCALE 2.0E-3 Sets the zoom horizontal scale to 2ms.	

Trigger Commands

:TRIGger:TYPe (Set) →
→ (Query)

Description	Sets or queries the trigger type.	
Syntax	:TRIGger:TYPe {EDGE LOGic PULSEWidth VIDEo RUnt RISEFall BUS TIMEOut ? }	
Parameter	EDGE	Edge trigger
	LOGic	Logic trigger
	PULSEWidth	Pulse width trigger
	VIDEo	Video trigger
	RUnt	Runt trigger
	RISEFall	Rise and fall trigger
	BUS	Bus trigger
	TIMEOut	Timeout trigger

Return parameter Returns the trigger type.

Example :TRIGger:TYPe EDGE
Sets the trigger type to edge.

:TRIGger:SOURce (Set) →
→ (Query)

Description	Sets or queries the trigger source.	
Syntax	:TRIGger:SOURce { CH1 CH2 CH3 CH4 EXT EXT/5 LINE ? }	
Parameter	CH1 to CH4	Channel 1 to channel 4
	EXT	External source
	EXT/5	External divided by 5
	LINE	AC Line

Return parameter Returns the trigger source.

Example :TRIGger:SOURce CH1
Sets the trigger source to channel 1.

:TRIGger:COUple (Set) →
→ (Query)

Description Sets or queries the trigger coupling.
Note Applicable for edge and delay triggers only.

Syntax :TRIGger:COUple {AC | DC | HF | ?}

Parameter	AC	AC mode
	DC	DC mode
	HF	High frequency rejection

Return parameter Returns the trigger coupling.

Example :TRIGger:COUple AC
Sets the trigger coupling to AC.

:TRIGger:MODE (Set) →
→ (Query)

Description Sets or queries the trigger mode.

Syntax :TRIGger:MODE {AUTo | NORMal | ?}

Parameter	AUTo	Auto trigger (Untriggered roll)
	NORMal	Normal trigger

Return parameter Returns the trigger mode.

Example :TRIGger:MODE NORMAL
Sets the trigger mode to normal.

:TRIGger:HOLDoff (Set) →
→ (Query)

Description Sets or queries the holdoff time.

Syntax :TRIGger:HOLDoff {<NRf> | ?}

Parameter	<NRf>	Holdoff time
-----------	-------	--------------

Return parameter <NR3> Returns the trigger holdoff time.

Example :TRIGger:HOLDoff 1.00E-8
Sets the trigger holdoff time to 10ns.

:TRIGger:LEVel (Set) →
→ (Query)

Description Sets or queries the level.

Note Not applicable to Pulse Runt and Rise & Fall triggers.

Syntax :TRIGger:LEVel {SETTO50 | <NRf> | ?}

Related commands :TRIGger:TYPe

Parameter	<NRf>	Trigger level value.
	SETTO50	Sets the trigger level to the User level (50% by default).

Return parameter <NR3> Returns the trigger level.

Example :TRIGger:LEVel 3.30E-1
Sets the trigger level to 330mV/mA.

:TRIGger:HLEVel (Set) →
→ (Query)

Description Sets or queries the high trigger level.

Note Applicable for Rise and Fall/Pulse Runt triggers.

Syntax :TRIGger:HLEVel {<NRf> | ?}

Related commands :TRIGger:TYPe

Parameter	<NRf>	High level value.
-----------	-------	-------------------

Return parameter	<NR3>	Returns the trigger high level.
------------------	-------	---------------------------------

Example :TRIGger:HLEVel 3.30E-1
Sets the trigger high level to 330mV/mA.

		Set →
		← Query
:TRIGger:LLEVel		
Description	Sets or queries the low trigger level.	
Note	Applicable for Rise and Fall/Pulse Runt triggers.	
Syntax	:TRIGger:LLEVel {<NRf> ?}	
Related commands	:TRIGger:TYPe	
Parameter	<NRf>	Low level value.
Return parameter	<NR3>	Returns the trigger low level.
Example	:TRIGger:LLEVel -3.30E-3 Sets the trigger low level to -330mV/mA.	

		Set →
		← Query
:TRIGger:LOGic:FUNction		
Description	Sets or queries the logical combination of the input channels for logic trigger.	
Syntax	:TRIGger:LOGic:FUNction {AND NAND NOR OR} :TRIGger:LOGic:FUNction?	
Related commands	:TRIGger:LOGic:PATtern:INPut:D<X>	
Parameter	AND	Sets the AND mode of define logic.
	NAND	Sets the NAND mode of define logic.
	NOR	Sets the NOR mode of define logic.
	OR	Sets the OR mode of define logic.
Example 1	TRIGger:LOGic:FUNction? >AND	
Example 2	TRIGger:LOGic:FUNction NAND Sets the NAND mode of define logic.	

:TRIGger:LOGic:PATtern:INPut:D<x> (Set) →
→ (Query)

Description	Sets or returns the logic trigger input for the specified digital channel.	
Syntax	:TRIGger:LOGic:PATtern:INPut:D<x>{HIGH LOW X} :TRIGger:LOGic:PATtern:INPut:D<x>?	
Parameter	<x>	It is the channel number.
	HIGH	Sets the logic high state.
	LOW	Sets the logic low state.
	X	Sets a “don’t care” state.
Example	:TRIGger:LOGic:PATtern:INPut:D0? >X	

:TRIGger:LOGic:PATtern:DELTatime (Set) →
→ (Query)

Description	Sets or returns the pattern trigger delta time value.	
Syntax	:TRIGger:LOGic:PATtern:DELTatime <NR3> :TRIGger:LOGic:PATtern:DELTatime?	
Related commands	:TRIGger:LOGic:PATtern:WHEn	
Parameter	<NR3>	It is a floating point value with exponent that sets the pattern trigger time value. A range of 1E-9 (1 ns) to 10.0E0 (10 s).
Example 1	:TRIGger:LOGic:PATtern:DELTatime 8.960e-05	
Example 2	:TRIGger:LOGic:PATtern:DELTatime? >8.960e-05	

:TRIGger:LOGic:PATtern:WHEn

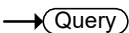
Description	Sets or returns the pattern logic condition on which to trigger the oscilloscope.	
Syntax	:TRIGger:LOGic:PATtern:WHEn {TRUE FALSE LESSthan MOREthan EQUAL UNEQUAL} :TRIGger:LOGic:PATtern:WHEn?	
Parameter	TRUE	Set true mode.
	FALSE	Set false mode.
	LESSTHAN	Set less than mode (Is True < time period (set in :TRIGger:LOGic:PATtern: DELTatime)).
	MORETHAN	Set more than mode (Is True > time period (set in :TRIGger:LOGic:PATtern: DELTatime)).
	EQUAL	Set equal mode (Is True = time period (set in: TRIGger:LOGic: PATtern: DELTatime)).
	UNEQUAL	Set unequal mode (Is True ≠ time period (set in :TRIGger:LOGic:PATtern: DELTatime)).
Example 1	:TRIGger:LOGic:PATtern:WHEn FALSE	
Example 2	:TRIGger:LOGic:PATtern:WHEn? >FALSE	

		Set →
		→ Query
:TRIGger:EDGE:SLOP		
Description	Sets or queries the trigger slope.	
Syntax	:TRIGger:EDGE:SLOP {RISe FALL ? }	
Related commands	:TRIGger:TYPe	
Parameter	RISe	Rising slope
	FALL	Falling slope
Return parameter	Returns the trigger slope.	
Example	:TRIGger:EDGE:SLOP FALL Sets the trigger slope to falling.	

		Set →
		→ Query
:TRIGger:PULSEWidth:POLarity		
Description	Sets or queries the pulse width trigger polarity.	
Syntax	:TRIGger:PULSEWidth:POLarity {POSitive NEGative ? }	
Related commands	:TRIGger:TYPe	
Parameter	POSitive	Positive polarity
	NEGative	Negative polarity
Return parameter	Returns the pulse width polarity.	
Example	:TRIGger:PULSEWidth:POLarity POSitive Sets the pulse width polarity to positive.	

:TRIGger:RUNT:POLarity



Description	Sets or queries the Pulse Runt trigger polarity.	
Syntax	:TRIGger:RUNT:POLarity { POSitive NEGative ? }	
Related commands	:TRIGger:TYPe	
Parameter	POSitive	Positive polarity
	NEGative	Negative polarity
Return parameter	Returns the pulse runt trigger polarity.	
Example	:TRIGger:RUNT:POLarity POSitive Sets the Pulse Runt trigger polarity to positive.	

:TRIGger:RUNT:WHEn



Description	Sets or queries the Pulse Runt trigger conditions.	
Syntax	:TRIGger:RUNT:WHEn {MOREthan LESSthan EQual ? }	
Related commands	:TRIGger:TYPe :TRIGger:RUNT:TIME	
Parameter	MOREthan	>
	LESSthan	<
	EQual	=
Return parameter	Returns the pulse runt trigger condition.	
Example	:TRIGger:RUNT:WHEn EQual Sets the Pulse Runt trigger condition to equal (=).	

Set →
→ Query

:TRIGger:RUNT:TIME

Description	Sets or queries the Pulse Runt trigger time.	
Syntax	:TRIGger:RUNT:TIME {<NRf> ? }	
Related commands	:TRIGger:TYPe :TRIGger:RUNT:WHEn	
Parameter	<NRf>	Pulse runt time (30nS to 10S)
Return Parameter	<NR3>	Returns the runt time in seconds.
Example	:TRIGger:RUNT:TIME 4.00E-5 Sets the runt time to 40.0uS.	

Set →
→ Query

:TRIGger:RISEFall:SLOP

Description	Sets or queries the Rise & Fall slope.	
Syntax	:TRIGger:RISEFall:SLOP {RISe FALL ? }	
Parameter	RISe	Rising slope
	FALL	Falling slope
Return parameter	Returns the rise & fall slope.	
Example	:TRIGger:RISEFall:SLOP RISe Sets the Rise & Fall slope to rising.	

Set →
→ Query

:TRIGger:RISEFall:WHEn

Description	Sets or queries the rise/fall trigger conditions.	
Syntax	:TRIGger:RISEFall:WHEn {MOREthan LESSthan EQual ? }	
Related commands	:TRIGger:TYPe :TRIGger:RISEFall:TIME	
Parameter	MOREthan	>
	LESSthan	<

Equal =

Return parameter Returns the rise/fall trigger condition.

Example :TRIGger:RISEFall:WHEN Equal
Sets the Rise and Fall trigger condition to equal (=).

:TRIGger:RISEFall:TIME (Set) →
→ (Query)

Description Sets or queries the Rise and Fall time.

Syntax :TRIGger:RISEFall:TIME {<NRF> | ? }

Related commands :TRIGger:TYPE
:TRIGger:RISEFall:WHEN

Parameter <NRF> Rise and Fall time (30nS to 10S)

Return Parameter <NR3> Returns the rise and fall time in seconds.

Example :TRIGger:RISEFall:TIME 4.00E-5
Sets the trigger rise & fall to 40.0us.

:TRIGger:VIDeo:TYPE (Set) →
→ (Query)

Description Sets or queries the video trigger type.

Syntax :TRIGger:VIDeo:TYPE {NTSC | PAL | SECAM | ? }

Related commands :TRIGger:TYPE

Parameter	NTSC	NTSC
	PAL	PAL
	SECAM	SECAM

Return parameter Returns the video trigger type.

Example :TRIGger:VIDeo:TYPE NTSC
Sets the video trigger to NTSC.

Set →

→ Query

:TRIGger:VIDeo:FIELD

Description	Sets or queries the video trigger field.	
Syntax	:TRIGger:VIDeo:FIELD { FIELD1 FIELD2 ALLFields ALLLines NUMERic? }	
Related commands	:TRIGger:TYPe	
Parameter	FIELD1	Trigger on field 1
	FIELD2	Trigger on field 2
	ALLFields	Trigger on all fields
	ALLLines	Trigger on all lines
	NUMERic	Specific lines

Return parameter Returns the video trigger field.

Example :TRIGger:VIDeo:FIELD ALLFields
Sets the video trigger to trigger on all fields.

Set →

→ Query

:TRIGger:VIDeo:LINE

Description	Sets or queries the video trigger line.	
Syntax	:TRIGger:VIDeo:LINE {<NR1> ?}	
Related commands	:TRIGger:TYPe	
Parameter	<NR1>	Video line
Return parameter	<NR3>	Returns the video trigger line.

Example :TRIGger:VIDeo:LINE 1
Sets the video trigger to line 1.

Set →
→ Query

:TRIGger:PULSe:WHEn

Description	Sets or queries the pulse width trigger conditions.
Syntax	:TRIGger:PULSe:WHEn { MOREthan LESSthan EQual ? }
Related commands	:TRIGger:TYPe :TRIGger:PULSe:TIME
Parameter	MORE than > LESSthan < EQual =
Return parameter	Returns the pulse width trigger conditions.
Example	:TRIGger:PULSe:WHEn EQual Sets the trigger pulse width conditions to equal (=).

Set →
→ Query

:TRIGger:PULSe:TIME

Description	Sets or queries the pulse width time.
Syntax	:TRIGger:PULSe:TIME {<NRf> ?}
Related commands	:TRIGger:TYPe :TRIGger:PULSe:WHEn
Parameter	<NRf> Pulse width time (30ns~10s)
Return parameter	<NR3> Returns the pulse width time in seconds.
Example	:TRIGger:PULSe:TIME 4.00E-5 Sets the trigger pulse width to 40.0us.

Set →

→ Query

:TRIGger:TIMEOut:TIMER

Description	Sets or returns timeout trigger time.	
Syntax	:TRIGger:TIMEOut:TIMER {<NRf> ? }	
Related commands	:TRIGger:TIMEOut:WHEn	
Parameter	<NRf>	Timeout time. (30nS to 10S).
Return parameter	Returns the timeout time as <NR3>.	
Example	:TRIGger:TIMEOut:TIMER? 8.960e-05	

:TRIGger:STATe

→ Query

Description	Returns the current state of the triggering system.	
Syntax	:TRIGger:STATe?	
Return parameter	*ARMED	Indicates that the oscilloscope is acquiring pretrigger information.
	*AUTO	Indicates that the oscilloscope is in the automatic mode and acquires data even in the absence of a trigger.
	*READY	Indicates that all pretrigger information has been acquired and that the oscilloscope is ready to accept a trigger.
	*SAVE	Indicates that the oscilloscope is in save mode and is not acquiring data.
	*TRIGGER	Indicates that the oscilloscope triggered and is acquiring the post trigger information.

Example :TRIGger:STATe?
 AUTO
 The trigger is in auto mode.

:TRIGger:BUS:B1:I2C:CONDition

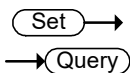

Description	Sets or queries the I ² C trigger conditions.	
Syntax	:TRIGger:BUS:B1:I2C:CONDition {START STOP REPEATstart ACKMISS ADDRess DATA ADDRANDDATA ? }	
Parameter	START	Set Start as the I ² C trigger condition.
	STOP	Set Stop as the I ² C trigger condition.
	REPEATstart	Set Repeat of Start as the I ² C trigger condition.
	ACKMISS	Set Missing Acknowledgement as the I ² C trigger condition.
	ADDRess	Set Address as the I ² C trigger condition.
	DATA	Set Data as the I ² C trigger condition.
	ADDRANDDATA	Set Address and Data as the I ² C trigger condition.
Return parameter	Returns the I ² C bus trigger condition.	
Example	:TRIGger:BUS:B1:I2C:CONDition ADDRess Set Address as the I ² C trigger condition.	

:TRIGger:BUS:B1:I2C:ADDRess:MODE (Set) →
→ (Query)

Description	Sets or queries the I ² C addressing mode (7, 8 or 10 bits).	
Syntax	:TRIGger:BUS:B1:I2C:ADDRess:MODE {ADDR7 ADDR8 ADDR10 ? }	
Related commands	:TRIGger:BUS:B1:I2C:CONDition	
Parameter	ADDR7	7 bit addressing
	ADDR8	8 bit addressing
	ADDR10	10 bit addressing
Example	:TRIGger:A:I2C:ADDRess:MODE ADDR7 The addressing mode is currently set to 7 bits.	

:TRIGger:BUS:B1:I2C:ADDRess:VALue (Set) →
→ (Query)

Description	Sets or queries the I ² C bus address value when the I ² C bus is set to trigger on Address or Address/Data.	
Syntax	:TRIGger:BUS:B1:I2C:ADDRess:VALue {<string> ? }	
Related commands	:TRIGger:BUS:B1:I2C:ADDRess:MODE	
Parameter	<sting>	7/10 characters, must be enclosed in double quotes, "string". x = don't care 1 = binary 1 0 = binary 0
Return Parameter	Returns the address value.	
Example1	:TRIGger:BUS:B1:I2C:ADDRess:MODE ADDR7 :TRIGger:BUS:B1:I2C:ADDRess:VALue "xxx0101" Sets the address to XXX0101	

Example 2 :TRIGger:BUS:B1:I2C:ADDRess:VALue?
 XXX0101

Set →
 → Query

Description Sets or queries the address bit as read write or don't care.

Note This setting only applies when the I²C trigger is set to trigger on Address or Address/Data

Syntax :TRIGger:BUS:B1:I2C:ADDRess:DIRection { READ | WRITE | NOCARE | ? }

Related commands :TRIGger:BUS:B1:I2C:CONDition

Parameter	READ	Set read as the data direction.
	WRITE	Set write as the data direction.
	NOCARE	Set either as the data direction.

Return Parameter Returns the direction (READ, WRITE, NOCARE).

Example :TRIGger:BUS:B1:I2C:ADDRess:DIRection READ
 Sets the direction to READ.

Set →
 → Query

Description Sets or queries the data size in bytes for the I²C bus.

Note This setting only applies when the I²C trigger is set to trigger on Data or Address/Data

Syntax :TRIGger:BUS:B1:I2C:DATA:SIZE {<NR1> | ? }

Related commands :TRIGger:BUS:B1:I2C:CONDition

Parameter	<NR1>	Number of data bytes (1 to 5).
------------------	--------------------	--------------------------------

Return parameter	<NR1>	Returns the number of bytes.
-------------------------	--------------------	------------------------------

Example :TRIGger:BUS:B1:I2C:DATA:SIZE 3
Sets the number of bytes to 3.

:TRIGger:BUS:B1:I2C:DATA:VALue (Set) →
← (Query)

Description Sets or queries the triggering data value for the I²C bus when the I²C bus is set to trigger on Data or Address/Data.

Syntax :TRIGger:BUS:B1:I2C:DATA:VALue {<string> | ? }

Related commands :TRIGger:BUS:B1:I2C:DATA:SIZE

Parameter	<string>	The number of characters in the string depends on the data size setting. The string must be enclosed in double quotes, "string". x = don't care 1 = binary 1 0 = binary 0
-----------	----------	--

Return Parameter Returns the data value.

Example1 :TRIGger:BUS:B1:I2C:DATA:SIZE 1
:TRIGger:BUS:B1:I2C:DATA:VALue "1x1x0101"
Sets the value to XXX0101

Example 2 :TRIGger:BUS:B1:I2C:DATA:VALue?
1X1X0101

:TRIGger:BUS:B1:UART:CONDition (Set) →
← (Query)

Description Sets or queries the UART triggering condition.

Syntax :TRIGger:BUS:B1:UART:CONDition { START | ERRor | CERRor | DATA | ? }

Parameter	START	Set trigger on the start bit.
	ERRor	Set trigger on any UART error.

	CERRor	Set trigger on the a specific error
	DATA	Set trigger when specific UART data is received.
Return Parameter	Returns the triggering condition.	
Example	:TRIGger:BUS:B1:UART:CONDition START Sets the UART bus to trigger on start bit.	
	:TRIGger:BUS:B1:UART:RX:DATA:SIZE	
Description	Sets or queries the number of bytes for UART data.	
Note	This setting only applies when the UART trigger is set to trigger on Rx Data	
Syntax	:TRIGger:BUS:B1:UART:RX:DATA:SIZE {<NR1> ?}	
Related commands	:TRIGger:BUS:B1:UART:CONDition	
Parameter	<NR1>	Number of bytes (5, 6, 7, 8).
Return parameter	<NR1>	Returns the number of bytes.
Example	:TRIGger:BUS:B1:UART:RX:DATA:SIZE 5 Sets the number of bytes to 5.	

:TRIGger:BUS:B1:UART:RX:DATA:VALue (Set) →
→ (Query)

Description Sets or queries the triggering data value for the UART bus when the bus is set to trigger on Rx Data.

Syntax :TRIGger:BUS:B1:UART:RX:DATA:VALue {<string> | ? }

Related commands :TRIGger:BUS:B1:UART:RX:DATA:SIZE

Parameter	<string>	The number of characters in the string depends on the data size setting. The string must be enclosed in double quotes, "string". x = don't care 1 = binary 1 0 = binary 0
------------------	-----------------------	--

Return Parameter Returns the data value.

Example 1 :TRIGger:BUS:B1:UART:CONDition RXDATA
:TRIGger:BUS:B1:UART:RX:DATA:SIZE 1
:TRIGger:BUS:B1:UART:RX:DATA:VALue "1x1x0101"
Sets the value to 1x1x0101

Example 2 :TRIGger:BUS:B1:UART:RX:DATA:VALue?
1X1X0101

:TRIGger:BUS:B1:UART:TX:DATA:SIZE (Set) →
→ (Query)

Description Sets or queries the number of bytes for UART data.

Note This setting only applies when the UART trigger is set to trigger on Tx Data

Syntax :TRIGger:BUS:B1:UART:TX:DATA:SIZE {<NR1> | ? }

Related commands :TRIGger:BUS:B1:UART:CONDition

Parameter	<NR1>	Number of bytes (5, 6, 7, 8).
Return parameter	<NR1>	Returns the number of bytes.
Example	:TRIGger:BUS:B1:UART:TX:DATA:SIZE 5 Sets the number of bytes to 5.	

:TRIGger:BUS:B1:UART:TX:DATA:VALue  

Description Sets or queries the triggering data value for the UART bus when the bus is set to trigger on Tx Data.

Syntax :TRIGger:BUS:B1:UART:TX:DATA:VALue {<string> | ? }

Related commands :TRIGger:BUS:B1:UART:TX:DATA:SIZE

Parameter	<sting>	The number of characters in the string depends on the data size setting. The string must be enclosed in double quotes, "string". x = don't care 1 = binary 1 0 = binary 0
-----------	---------	--

Return Parameter Returns the data value.

Example1 :TRIGger:BUS:B1:UART:CONDition TXDATA
:TRIGger:BUS:B1:UART:TX:DATA:SIZE 1
:TRIGger:BUS:B1:UART:TX:DATA:VALue "1x1x0101"
Sets the value to 1x1x0101

Example 2 :TRIGger:BUS:B1:UART:TX:DATA:VALue?
1X1X0101

:TRIGger:BUS:B1:CAN:CONDition



Description	Sets or returns the CAN trigger condition.	
Syntax	:TRIGger:BUS:B1:CAN:CONDition {SOF FRAMetype IDentifier DATA IDANDDATA EOF ACKMISS STUFFERR ?}	
Parameter/ Return parameter	SOF	Triggers on a start of frame
	FRAMetype	Triggers on the type of frame
	IDentifier	Triggers on a matching identifier
	DATA	Triggers on matching data
	IDANDDATA	Triggers on matching identifier and data field
	EOF	Triggers on the end of frame
	ACKMISS	Triggers on a missing acknowledge
	STUFFERR	Triggers on a bit stuffing error

Example1 :TRIGger:BUS:B1:CAN:CONDition SOF
Triggers on a start of frame.

Example2 :TRIGger:BUS:B1:CAN:CONDition?
>SOF

:TRIGger:BUS:B1:CAN:FRAMetype



Description	Sets or returns the frame type for a CAN FRAMetype trigger.	
Syntax	:TRIGger:BUS:B1:CAN:FRAMetype {DATA REMote ERRor OVERLoad ?}	
Parameter/ Return parameter	DATA	Sets the frame type to data frame
	REMote	Sets the frame type to remote frame
	ERRor	Sets the frame type to error frame
	OVERLoad	Sets the frame type to overload

Example :TRIGger:BUS:B1:CAN:FRAMeType DATA
Sets the frame type to DATA.

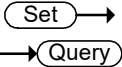
:TRIGger:BUS:B1:CAN:IDentifier:MODE 

Description Sets or returns the CAN identifier mode for the bus.

Syntax :TRIGger:BUS:B1:CAN:IDentifier:MODE {STANDard|EXTended|?}

Parameter/ Return parameter	STANDard	Standard addressing mode
	EXTended	Extended addressing mode

Example :TRIGger:BUS:B1:CAN:IDentifier:MODE?>STANDARD
Returns the addressing mode.

:TRIGger:BUS:B1:CAN:DATA:SIZE 

Description Sets or returns the length of the data string in bytes for a CAN trigger.
Note: Only applicable when the condition is set to DATA or IDANDDATA.

Syntax :TRIGger:BUS:B1:CAN:DATA:SIZE {<NR1>|?}

Parameter/ Return parameter	<NR1>	1~8 (bytes)
--------------------------------	-------	-------------

Example :TRIGger:BUS:B1:CAN:DATA:SIZE?>1
:TRIGger:BUS:B1:CAN:DATA:SIZE 2
:TRIGger:BUS:B1:CAN:DATA:SIZE?>2

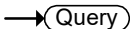
		 
:TRIGger:BUS:B1:CAN:DATA:VALue		
Description	Sets or returns the binary data string to be used for a CAN trigger. Note: Only applicable when the condition is set to DATA or IDANDDATA.	
Related Commands	:TRIGger:BUS:B1:CAN:DATA:SIZE	
Syntax	:TRIGger:BUS:B1:CAN:DATA:VALue {<string> ?}	
Parameter/Return parameter	<string>	The size of the string depends on the data size setting. The string must be enclosed in double quotes, "string". String contents: x = don't care 1 = binary 1 0 = binary 0
Example	:TRIGger:BUS:B1:CAN:DATA:SIZE 1 :TRIGger:BUS:B1:CAN:DATA:VALue "01010X1X" :TRIGger:BUS:B1:CAN:DATA:VALue? >01010X1X	

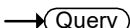
		 
:TRIGger:BUS:B1:LIN:CONDition		
Description	Sets or returns the LIN trigger condition.	
Syntax	:TRIGger:BUS:B1:LIN:CONDition {SYNCFIELD IDENTIFIER DATA IDANDDATA WAKEUP SLEEP ERROR ?}	
Parameter/Return parameter	SYNCFIELD	Sets the LIN trigger condition to the sync field.
	IDENTIFIER	Sets the LIN trigger condition to identifier field.

DATA	Sets the LIN trigger condition to the data field.
IDANDDATA	Sets the LIN trigger condition to identifier and data field
WAKEup	Sets the LIN trigger condition to wake up.
SLEEP	Sets the LIN trigger condition to sleep.
ERRor	Sets the LIN trigger condition to error.

Example

```
:TRIGger:BUS:B1:LIN:CONDition?  
>IDANDDATA  
:TRIGger:BUS:B1:LIN:CONDition DATA  
:TRIGger:BUS:B1:LIN:CONDition?  
>DATA
```

		Set →
		→ Query
:TRIGger:BUS:B1:LIN:DATA:SIZE		
Description	Sets or returns the length of the data string in bytes for the LIN trigger. Note: Only applicable when the condition is set to DATA or IDANDDATA.	
Syntax	:TRIGger:BUS:B1:LIN:DATA:SIZE {<NR1> ?}	
Parameter/ Return parameter	<NR1>	1~8 (bytes)
Example	:TRIGger:BUS:B1:LIN:DATA:SIZE? >1 :TRIGger:BUS:B1:LIN:DATA:SIZE 2 :TRIGger:BUS:B1:LIN:DATA:SIZE? >2	

		Set →
		→ Query
:TRIGger:BUS:B1:LIN:DATA:VALue		
Description	Sets or returns the binary data string to be used for the LIN trigger. Note: Only applicable when the condition is set to DATA or IDANDDATA.	
Related Commands	:TRIGger:BUS:B1:LIN:DATA:SIZE	
Syntax	:TRIGger:BUS:B1:LIN:DATA:VALue {<string> ?}	
Parameter/ Return parameter	<string>	The size of the string depends on the data size setting. The string must be enclosed in double quotes, "string". String contents: x = don't care 1 = binary 1 0 = binary 0

Example :TRIGger:BUS:B1:LIN:DATA:SIZE 1
 :TRIGger:BUS:B1:LIN:DATA:VALue "01010X1X"
 :TRIGger:BUS:B1:LIN:DATA:VALue?
 >01010X1X

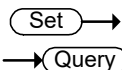

:TRIGger:BUS:B1:SPI:DATA:SIZE

Description Sets or queries the number of words for SPI data.

 Note This setting only applies when the SPI trigger is set to trigger on MISO, MOSI or MISO/MOSI

Syntax :TRIGger:BUS:B1:SPI:DATA:SIZE {<NR1> | ?}

Related commands :TRIGger:BUS:B1:SPI:CONDition

Parameter <NR1> Number of words (4 to 32).

Return parameter <NR1> Returns the number of words.

Example :TRIGger:BUS:B1:SPI:DATA:SIZE 10
 Sets the number of words to 10.

System Commands

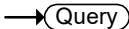
		
<code>:SYSTem:LOCK</code>		
<hr/>		
Description	Turns the panel lock on off.	
Syntax	<code>:SYSTem:LOCK {OFF ON ? }</code>	
Parameter	OFF	System lock off
	ON	System lock on
Return parameter	Returns the status of the panel lock (ON, OFF).	
Example	<code>:SYSTem:LOCK ON</code> Turns the panel lock on.	

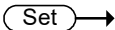
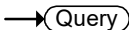
		
<code>:SYSTem:ERRor</code>		
<hr/>		
Description	Queries the error queue.	
Syntax	<code>:SYSTem:ERRor?</code>	
Return parameter	Returns the last message in the error queue.	
Example	<code>:SYSTem:ERRor?</code> +0, "No error."	

Save/Recall Commands

:RECALL:SETUp

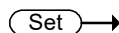

Description	Recalls setup settings from memory or USB.	
Syntax	:RECALL:SETUp {S1~S20 <file path> ("Disk:/xxx.SET", "USB:/xxx.SET")}	
Parameter	S1~S20	Recall Set1~Set20
	<file path>	Recall a file from the DSO internal files system or from a USB flash drive.
Example	:RECALL:SETUp S1 Recalls setup setting S1 from memory. :RECALL:SETUp "Disk:/DS0001.SET" Recall the setup setting DS0001.SET from the internal memory.	

:SAVe:IMAGe

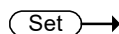

Description	Saves a screen image to the assigned file path with a specified filename.	
Syntax	:SAVe:IMAGe {<file path> ("Disk:/xxx.PNG", "USB:/xxx.BMP")}	
Related commands	:SAVe:IMAGe:FILEFormat :SAVe:IMAGe:INKSaver	
Parameter	xxx.PNG or xxx.BMP	File name (8 characters max)
Example	:SAVe:IMAGe "Disk:/pic1.PNG" Saves a screen image named pic1.png to the root directory (Disk:/) of the scope. :SAVe:IMAGe "USB:/pic1.BMP" Saves a screen image named pic1.bmp to the root directory of the external USB flash disk.	

Set →
 → Query

:SAVE:IMAGe:FILEFormat

Description	Sets the file format for image.	
Syntax	:SAVE:IMAGe:FILEFormat {PNG BMP JPG Tiff ?}	
Related commands	:SAVE:IMAGe :SAVE:IMAGe:INKSaver	
Parameter	PNG	Sets the file format to PNG
	BMP	Sets the file format to BMP
	JPG	Sets the file format JPG
	TIFF	Set the file format TIFF
Return parameter	Returns the file format (PNG, BMP, JPG, TIFF).	
Example	:SAVE:IMAGe:FILEFormat PNG Sets the image file format to PNG.	

Set →
 → Query

:SAVE:IMAGe:INKSaver

Description	Turns Ink Saver on or off.	
Syntax	:SAVE:IMAGe:INKSaver {OFF ON ?}	
Related commands	:SAVE:IMAGe :SAVE:IMAGe:FILEFormat	
Parameter	OFF	Turns Inksaver off.
	ON	Turns Inksaver on.
Return parameter	Returns Ink Saver status (ON, OFF).	
Example	:SAVE:IMAGe:INKSaver ON Turns Ink Saver on.	

Set →

Description	Saves the current setup to internal memory (Set1~Set20) or the designated file path.
-------------	--

Syntax	:SAVe:SETUp {<file path> (“Disk:/xxx.SET”, “USB:/xxx.SET”) S1~S20}	
Parameter	S1~S20	Saves the setup to Set1~Set20
	File path	Saves the setup to disk to the specified file path.
Example	:SAVe:SETUp S1 Saves the current setup to Set1 in internal memory. :SAVe:SETUp “Disk:/DS0001.SET” Saves the current setup to DS0001.SET in the root directory of the internal memory.	

:SAVe:WAVEform

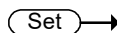

Description	Saves a waveform to internal memory or to a designated file path.	
Related commands	:SAVe:WAVEform:FILEFormat	
Syntax	:SAVe:WAVEform {CH1~REF4, REF<X> } {CH1~REF4, W1~W20} {CH1~ALL, file path}	
Parameter	CH1~REF4,	CH1~CH4, Math, REF1~4
	<X>	1,2,3,4 (REF1, REF2, REF3, REF4)
	W1~W20	Wave1~Wave20
	ALL	All the displayed waveforms on screen.
	File path	Saves the waveform(s) to disk or USB to the specified file path. (LSF or CSV, but note that detail CSV can't be recalled to the scope.)
Example 1	:SAVe:WAVEform CH1, REF2 Saves the channel1 waveform to REF2.	

Example 2 :SAVe:WAVEform ALL, "Disk:/ALL001"
 Creates a folder which named "ALL001" and saves all displayed waveform to the "ALL001" directory with LSF format

Example 3 :SAVe:WAVEform ALL, "Disk:/ALL002.CSV"
 Save the all channels waveform to root directory (Disk:/) of the internal flash disk with CSV format.

Example 4 :SAVe:WAVEform CH2, "Disk:/DS0003.LSF"
 Save the channel 2's waveform to root directory (Disk:/) of the internal flash disk with LSF format.

:SAVe:WAVEform:FILEFormat (Set) →
 ← (Query)

Description Sets the waveform savefile format.

Syntax :SAVe:WAVEform:FILEFormat {CSV | ZIP | MATLAB | ?}

Parameter	CSV	Set the file format to CSV
	ZIP	Set the file format to ZIP
	MATlab	Set the file format to matlab

Return parameter Returns the file format (CSV, ZIP, MATLAB).

Example :SAVe:WAVEform:FILEFormat CSV
 Sets the file format to CSV.

Bus Decode Commands

:BUS<x>:STATe Set →
← Query

Description	Sets or queries the state of the bus.	
Syntax	:BUS<x>:STATe { OFF ON ? }	
Related commands	:BUS<x>:TYPE	
Parameter/Return parameter	<x>	1 or 2, indicating decoding 1 or 2
	OFF	Turns the bus off.
	ON	Turns the bus on.
Example	:BUS1:STATe ON Turns the bus 1 on.	

:BUS<x>:TYPE Set →
← Query

Description	Sets or queries the type of bus.	
Syntax	:BUS<x>:TYPE { UART I2C SPI CAN LIN ? }	
Related commands	:BUS<x>:STATE	
Parameter/Return parameter	<x>	1 or 2, indicating decoding 1 or 2
	UART	Set to UART mode.
	I2C	Sets to I2C mode.
	SPI	Set to SPI mode
	CAN	Sets to CAN mode.
	LIN	Sets to LIN mode.
Example	:BUS1:TYPE LIN Sets the bus to LIN mode.	

:BUS<x>:I2C:ADDRess:RWINClude



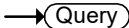

Description	Sets or queries whether the read/write bit is included in the I ² C address.	
Syntax	:BUS<x>:I2C:ADDRess:RWINClude { OFF ON ? }	
Related commands	:BUS<x>:STATE	
Parameter	<x>	1 or 2, indicating decoding 1 or 2
	OFF	The R/W bit is not included.
	ON	The R/W bit is included.
Return parameter	0	The R/W bit is not included.
	1	The R/W bit is included.
Example	:BUS1:I2C:ADDRess:RWINClude ON Includes the R/W bit in the I ² C address.	

:BUS<x>:I2C:SCLK:SOURce



Description	Sets or queries which channel is used for the I ² C SCLK source.	
Syntax	:BUS<x>:I2C:SCLK:SOURce { CH1 CH2 CH3 CH4 ? }	
Parameter/Return parameter	<x>	1 or 2, indicating decoding 1 or 2
	CH1 to CH4	Analog channels 1 ~ 4.
Example	:BUS1:I2C:SCLK:SOURce CH1 Sets channel 1 as the SCLK source.	

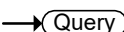



:BUS<x>:I2C:SCLK:THReshold

Description	Set or query the threshold of the currently selected SCL source for I2C decode.	
Syntax	:BUS<x>:I2C:SCLK:THReshold <NR3> :BUS<x>:I2C:SCLK:THReshold?	
Parameter/Return parameter	<x>	It can be 1 or 2, indicating decoding one or decoding two.
	<NR3>	Thresholds for each logic decoding channel (in Volts). Settings are rounded to the nearest allowable value.
Example	:BUS1:I2C:SCLK:THReshold 1.0 Set I2C the SCL selected source threshold for I2C decode 1 to 1V	

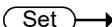

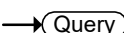

:BUS<x>:I2C:SDA:SOURce

Description	Sets or queries which channel is used for the I ² C SDA source.	
Syntax	:BUS<x>:I2C:SDA:SOURce{ CH1 CH2 CH3 CH4 ? }	
Parameter/Return parameter	<x>	1 or 2, indicating decoding 1 or 2
	CH1 to CH4	Analog channels 1 ~ 4.
Example	:BUS1:I2C:SDA:SOURce CH1 Sets channel 1 as the SDA source.	

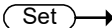

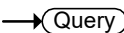

:BUS<x>:I2C:SDA:THReshold

Description	Set or query the threshold of the currently selected SDA source for I2C decode.	
Syntax	:BUS<x>:I2C:SDA:THReshold <NR3> :BUS<x>:I2C:SDA:THReshold?	

Parameter/Return parameter	<x>	It can be 1 or 2, indicating decoding one or decoding two.
	<NR3>	Thresholds for each logic decoding channel (in Volts). Settings are rounded to the nearest allowable value.

Example :BUS1:I2C:SDA:THReshold 1.0
 Set I2C the SDA selected source threshold for I2C decode 1 to 1V

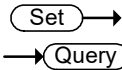

:BUS<x>:UART:BITRate

Description Sets or queries the UART bit rate.
 Syntax :BUS<x>:UART:BITRate {<NR1> | ? }

Parameter/Return parameter	<x>	1 or 2, indicating decoding 1 or 2
	<NR1>	UART bit rate in bps

Example :BUS1:UART:BITRate?
 >2400
 :BUS1:UART:BITRate 50
 :BUS1:UART:BITRate?
 >50

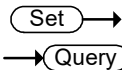

:BUS<x>:UART:DATABits

Description Sets or queries the number UART data for bus 1.
 Syntax :BUS1:UART:DATABits { 5 | 6 | 7 | 8 | ? }

Parameter/Return parameter	<x>	1 or 2, indicating decoding 1 or 2
	5	5 data bits in the UART frame.
	6	6 data bits in the UART frame.
	7	7 data bits in the UART frame.
	8	8 data bits in the UART frame.

Example :BUS1:UART:DATABits 7
Sets the UART frame to 7 bits.

:BUS<x>:UART:STOPBits 

Description Set or query UART decode stop bit.

Syntax :BUS<x>:UART:STOPBits {1|1.5|2}
:BUS<x>:UART:STOPBits?

Parameter/Return parameter <x> It can be 1 or 2, indicating decoding one or decoding two.

Example :BUS1:UART:STOPBits 1
Set decode stop bit to 1

:BUS<x>:UART:BITOrder 

Description Set or query UART decode bit order.

Syntax :BUS<x>:UART:BITOrder {MSB|LSB}
:BUS<x>:UART:BITOrder?

Parameter <x> It can be 1 or 2, indicating decoding one or decoding two.
MSB Bit order is in larger-endian mode.
LSB Bit order is in little-endian mode.

Example :BUS1:UART:BITOrder LSB
Set decode bit order to LSB

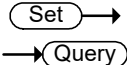
:BUS<x>:UART:SOURce 

Description Set or query UART decode source.

Syntax :BUS<x>:UART:SOURce {CH1|CH2|CH3|CH4}
:BUS<x>:UART:SOURce?

Parameter <x> It can be 1 or 2, indicating decoding one or decoding two.

CH1-4 Channel 1~4.

Example :BUS1:UART:SOURce CH
Set UART decode 1 source to CH1

:BUS<x>:UART:THReshold (Set) →
→ (Query)

Description Set or query UART decode threshold.

Syntax :BUS<x>:UART:THReshold <NR3>
:BUS<x>:UART:THReshold?

Parameter	<x>	It can be 1 or 2, indicating decoding one or decoding two.
	<NR3>	Thresholds for each logic decoding channel (in Volts). Settings are rounded to the nearest allowable value.

Example :BUS1:UART:THReshold 1.0
Set decode 1 threshold to 1V

:BUS<x>:UART:POLARity (Set) →
→ (Query)

Description Sets or returns the UART polarity.

Syntax :BUS<x>:UART: POLARity {NORMAL|INVerted}
:BUS<x>:UART: POLARity?

Parameter	<x>	1 or 2, indicating decoding 1 or 2
	Normal	Sets normal UART polarity.
	INVerted	Sets inverted UART polarity.

Example :BUS1:UART:POLARity NORMAL
:BUS1:UART:POLARity?
NORMAL

:BUS<x>:DISPlay:FORMAt



Description	Sets or queries the display format for the bus, either binary or hexadecimal.	
Syntax	:BUS<x>:DISPlay:FORMAt { BINary HEXadecimal ASCII DECimal ? }	
Parameter/Return parameter	<x>	1 or 2, indicating decoding 1 or 2
	BINary	Binary format
	HEXadecimal	Hexadecimal format
	DECimal	Decimal format
Example	:BUS1:DISPlay:FORMAt BINary Sets the display format to binary.	

:BUS<x>:CAN:SOURce



Description	Sets or returns the CAN input source.	
Syntax	:BUS<x>:CAN:SOURce { CH1 CH2 CH3 CH4 ? }	
Parameter/Return parameter	<x>	1 or 2, indicating decoding 1 or 2
	CH1 ~ CH4	Analog channel source
Example	:BUS1:CAN:SOURce? >CH1 Returns the CAN source.	

:BUS<x>:CAN:PROBe



Description	Sets or returns the signal type of the CAN bus.	
Syntax	:BUS1:CAN:PROBe { CANH CANL TX RX ? }	
Parameter/Return parameter	<x>	1 or 2, indicating decoding 1 or 2
	CANH	CAN-High
	CANL	CAN-Low

TX	Transmit
RX	Receive

Example

```
:BUS1:CAN:PROBe?
>CANH
:BUS1:CAN:PROBe CANL
:BUS1:CAN:PROBe?
>CANL
```

Set →
 → Query

:BUS<x>:CAN:SAMPLEpoint

Description Set or query the sample point of the CAN bus.

Syntax :BUS<x>:CAN:SAMPLEpoint?

Return Parameter Returns the sample point of the CAN bus as a percentage of the bit time.

Example

```
:BUS1:CAN:SAMPLEpoint?
50
```

Returns the sample point as a percentage.

Set →
 → Query

:BUS<x>:CAN:BITRate

Description Sets or returns the bit rate of the CAN bus.

Syntax :BUS<x>:CAN:BITRate
 {RATE10K|RATE20K|RATE50K|RATE125K|RATE250K|
 RATE500K|RATE800K|RATE1M | <NR1> | ?}

Parameter/Return parameter <x> 1 or 2, indicating decoding 1 or 2

RATE10K	10 kbps
RATE20K	20 kbps
RATE50K	50 kbps
RATE125K	125 kbps
RATE250K	250 kbps
RATE500K	500 kbps

RATE800K	800 kbps
RATE1M	1 Mbps
<NR1>	CAN bit rate in bps

Example :BUS1:CAN:BITRate?
>1000000

:BUS1:CAN:BITRate rate800k
:BUS1:CAN:BITRate?
>800000

:BUS1:CAN:BITRate 25000
:BUS1:CAN:BITRate?
>25000

:BUS<x>:LIN:BITRate (Set) →
→ (Query)

Description	Sets or returns the bit rate of the LIN bus.	
Syntax	:BUS<x>:LIN:BITRate {<NR1> ?}	
Parameter/Return parameter	<x>	1 or 2, indicating decoding 1 or 2
	<NR1>	LIN bit rate in bps.
Example	:BUS1:LIN:BITRate 9600 Sets the LIN bit rate to 9600bps.	

:BUS<x>:LIN:POLARity (Set) →
→ (Query)

Description	Sets or returns the LIN polarity.	
Syntax	:BUS<x>:LIN:POLARity {NORMAL INVerted ?}	
Parameter/Return parameter	<x>	1 or 2, indicating decoding 1 or 2
	NORMAL	Normal LIN polarity
	INVerted	Inverted LIN polarity
Example	:BUS1:LIN:POLARity? NORMAL Returns the LIN polarity.	

Set →
→ Query

:BUS<x>:LIN:SOURce

Description	Sets or returns the LIN data source.	
Syntax	:BUS<x>:LIN:SOURce {CH1 CH2 CH3 CH4}?	
Parameter/Return parameter	<x>	1 or 2, indicating decoding 1 or 2
	CH1 ~ CH4	Analog channel source
Example	:BUS1:LIN:SOURCE? >CH1 Returns the LIN source.	

Set →
→ Query

:BUS<x>:LIN:STANDard

Description	Sets or returns the LIN standard.	
Syntax	:BUS<x>:LIN:STANDard {V1X V2X BOTH ?}	
Parameter/Return parameter	<x>	1 or 2, indicating decoding 1 or 2
	V1X	Lin standard version 1.x
	V2X	Lin standard version 2.x
	BOTH	Both standards
Example	:BUS1:LIN:STANDard? >BOTH Returns the LIN standard.	

Set →
→ Query

:BUS<x>:LIN:THReshold

Description	Set or query LIN decode threshold.	
Syntax	:BUS<x>:LIN:THReshold <NR3> :BUS<x>:LIN:THReshold?	
Parameter	<x>	It can be 1 or 2, indicating decoding one or decoding two.

<NR3> Thresholds for each logic decoding channel (in Volts). Settings are rounded to the nearest allowable value.

Example :BUS1:LIN:THReshold 1.0
Set decode 1 threshold to 1V

:BUS<x>:SPI:FRAMING (Set) →
→ (Query)

Description Set or query decode mode of SPI decode.

Syntax :BUS<x>:SPI:FRAMING {SS|IDLEtime}
:BUS<x>:SPI:FRAMING?

Parameter **<x>** It can be 1 or 2, indicating decoding one or decoding two.
SS Chip select.
IDLEtime Timeout

Example :BUS1:SPI:FRAMING SS
Set decode 1 decode mode of SPI decode to SS

:BUS<x>:SPI:IDLETime (Set) →
→ (Query)

Description	Set or query SPI decode idle time.	
Syntax	:BUS<x>:SPI:IDLETime <NR3> :BUS<x>:SPI:IDLETime?	
Parameter	<x>	It can be 1 or 2, indicating decoding one or decoding two.
	<NR3>	Set decode idle time, unit is s.
Example	:BUS1:SPI:IDLETime 1 Set decode idle time to 1s	

:BUS<x>:SPI:SCLK:POLARity (Set) →
→ (Query)

Description	Sets or queries the polarity of the SCLK line for the SPI bus.	
Syntax	:BUS<x>:SPI:SCLK:POLARity { FALL RISE ? }	
Parameter/Return parameter	<x>	1 or 2, indicating decoding 1 or 2
	FALL	Sets the polarity to falling edge.
	RISE	Sets the polarity to rising edge.
Example	:BUS1:SPI:SCLK:POLARity FALL Sets the polarity to falling edge.	

:BUS<x>:SPI:SCLK:SOURce (Set) →
→ (Query)

Description	Sets or queries which channel is used for the SPI SCLK source.	
Syntax	:BUS<x>:SPI:SCLK:SOURce {CH1 CH2 CH3 CH4 ? }	
Parameter/Return parameter	<x>	1 or 2, indicating decoding 1 or 2
	CH1 to CH4	Analog channels CH1 to CH4

Example :BUS1:SPI:SCLK:SOURce CH1
Sets channel 1 as the SPI SCLK source.

:BUS<x>:SPI:SCLK:THReshold (Set) →
→ (Query)

Description Set or query SPI decode idle time.

Syntax :BUS<x>:SPI:SCLK:THReshold <NR3>
:BUS<x>:SPI:SCLK:THReshold?

Parameter	<x>	It can be 1 or 2, indicating decoding one or decoding two.
	<NR3>	Thresholds for each logic decoding channel (in Volts). Settings are rounded to the nearest allowable value.

Example :BUS<x>:SPI:SCLK:THReshold 1.0
Set threshold of the SCL selected source for SPI decode 1 to 1V

:BUS<x>:SPI:SS:POLARity (Set) →
→ (Query)

Description Sets or queries the polarity of the SS line for the SPI bus.

Syntax :BUS<x>:SPI:SS:POLARity { LOW | HIGH | ? }

Parameter/Return parameter	<x>	1 or 2, indicating decoding 1 or 2
	LOW	Active low polarity
	HIGH	Active high polarity

Example :BUS1:SPI:SS:POLARity LOW
Sets the SS line to active low.

:BUS<x>:SPI:SS:SOURce (Set) →
→ (Query)

Description	Sets or queries which channel is used for the SPI SS source.	
Syntax	:BUS<x>:SPI:SS:SOURce {CH1 CH2 CH3 CH4 ? }	
Parameter/Return parameter	<x> CH1 to CH4	1 or 2, indicating decoding 1 or 2 Analog channels CH1 to CH4
Example	:BUS1:SPI:SS:SOURce CH1 Sets channel 1 as the SPI SS source.	

:BUS<x>:SPI:SS:THReshold (Set) →
→ (Query)

Description	Set or query SPI decode chip select mode CS threshold.	
Syntax	:BUS<x>:SPI:SS:THReshold <NR3> :BUS<x>:SPI:SS:THReshold?	
Parameter/Return parameter	<x> <NR3>	It can be 1 or 2, indicating decoding one or decoding two. Thresholds for each logic decoding channel (in Volts). Settings are rounded to the nearest allowable value.
Example	:BUS1:SPI:SS:THReshold 1.0 Set SPI decode 1 chip select mode CS threshold to 1V.	

:BUS<x>:SPI:DATA{ :OUT | :MOSI } :THReshold (Set) →
→ (Query)

Description	Set or query SPI decode chip select mode MOSI threshold.	
Syntax	:BUS<x>:SPI:DATA{ :OUT :MOSI } :THReshold <NR3> :BUS<x>:SPI:DATA{ :OUT :MOSI } :THReshold?	

Parameter/Return parameter	<x>	It can be 1 or 2, indicating decoding one or decoding two.
	<NR3>	Thresholds for each logic decoding channel (in Volts). Settings are rounded to the nearest allowable value.

Example :BUS1:SPI:DATA{:OUT|:MOSI}:THReshold 1.0
Set SPI decode 1 chip select mode MOSI threshold to 1V

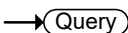
:BUS<x>:SPI:DATA{:IN|:MOSI}:THReshold  

Description Set or query SPI decode chip select mode MOSI threshold.

Syntax :BUS<x>:SPI:DATA{:IN|:MOSI}:THReshold <NR3>
:BUS<x>:SPI:DATA{:IN|:MOSI}:THReshold?

Parameter/Return parameter	<x>	It can be 1 or 2, indicating decoding one or decoding two.
	<NR3>	Thresholds for each logic decoding channel (in Volts). Settings are rounded to the nearest allowable value.

Example :BUS1:SPI:DATA{:IN|:MOSI}:THReshold 1.0
Set SPI decode 1 chip select mode MOSI threshold to 1V

:BUS<x>:SPI:WORDSize  

Description Sets the number of bits per word for the SPI bus.

Syntax :BUS<x>:SPI:WORDSize {<NR1> | ? }

Parameter/Return parameter	<x>	1 or 2, indicating decoding 1 or 2
	<NR1>	Bits per word (4~32)

Example :BUS1:SPI:WORDSize 4
Sets the word size to 4 bits per word.

Set →

→ Query

:BUS<x>:SPI:BITORder

Description	Sets or queries the bit order for the SPI bus.	
Syntax	:BUS<x>:SPI:BITORder {<NR1> ? }	
Parameter/Return parameter	<x>	1 or 2, indicating decoding 1 or 2
	<NR1>	0: MSB bit first 1: LSB bit first
Example	:BUS1:SPI:BITORder? 0 The bit order is currently set as MSB bit first.	

Set →

→ Query

:BUS<x>:SPI:MOSI:SOURce

Description	Sets or queries which channel is used for the SPI MOSI source.	
Syntax	:BUS<x>:SPI:MOSI:SOURce {OFF CH1 CH2 CH3 CH4 ? }	
Parameter/Return parameter	<x>	1 or 2, indicating decoding 1 or 2
	CH1 to CH4	Analog channels CH1 to CH4
	OFF	No MOSI source.
Example	:BUS1:SPI:MOSI:SOURce CH1 Sets channel 1 as the SPI MOSI source.	

:BUS<x>:SPI:MISO:SOURce

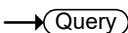

Description	Sets or queries which channel is used for the SPI MISO source.						
Syntax	:BUS<x>:SPI:MISO:SOURce{OFF CH1 CH2 CH3 CH4 ?}						
Parameter/Return parameter	<table border="1" style="width: 100%; border-collapse: collapse;"> <tr> <td style="width: 20%; border: none;"><x></td> <td style="border: none;">1 or 2, indicating decoding 1 or 2</td> </tr> <tr> <td style="border: none;">CH1 to CH4</td> <td style="border: none;">Analog channels CH1 to CH4</td> </tr> <tr> <td style="border: none;">OFF</td> <td style="border: none;">No MISO source.</td> </tr> </table>	<x>	1 or 2, indicating decoding 1 or 2	CH1 to CH4	Analog channels CH1 to CH4	OFF	No MISO source.
<x>	1 or 2, indicating decoding 1 or 2						
CH1 to CH4	Analog channels CH1 to CH4						
OFF	No MISO source.						
Example	:BUS1:SPI:MISO:SOURce CH1 Sets channel CH1 as the SPI MISO source.						

Label Commands



:CHANnel<X>:LABel.....	154
:CHANnel<X>:LABel:DISPlay.....	155
:REF<X>:LABel.....	155
:REF<X>:LABel:DISPlay.....	156
:BUS1:LABel.....	157
:BUS1:LABel:DISPlay.....	158

:CHANnel<X>:LABel

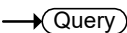

Description	Sets or returns the file label for the selected channel.	
Syntax	:CHANnel<X>:LABel {<string> ?}	
Related commands	:CHANnel<X>:LABel:DISPlay	
Parameter	<X>	Channel 1, 2, 3, 4
	<string>	The string must be no more than 8 characters and only contain alphanumeric characters in addition to period, dash and underscore characters. The string must be enclosed in double quotes, "string".
Return parameter	<string>	Returns the label for the selected channel. No return indicates that there has not been a file label assigned for the selected channel.
Example1	:CHANnel1:LABel "CH1_lab" Sets the channel 1 label as "CH1_lab".	
Example2	:CHANnel1:LABel? CH1_lab	

		 → → 
:CHANnel<X>:LABel:DISPlay		
Description	Turns the label on/off for the selected channel or returns its status.	
Syntax	:CHANnel<X>:LABel:DISPlay { OFF ON ? }	
Related commands	:CHANnel<X>:LABel	
Parameter	<X> OFF ON	Channel 1, 2, 3, 4 Turns the file label off for the selected channel. Turns the file label on for the selected channel.
Return parameter	Returns the status of the file label for the selected channel (ON, OFF).	
Example	:CHANnel1:LABel "CH1" :CHANnel1:LABel:DISPlay ON :CHANnel1:LABel:DISPlay? ON Sets the channel 1 label to "CH1" and then turns the label display on. The query return shows that the label is on.	

		 → → 
:REF<X>:LABel		
Description	Sets or returns the file label for the selected reference waveform.	
Syntax	:REF<X>:LABel {<string> ?}	
Related commands	:REF<X>:LABel:DISPlay	
Parameter	<X>	REF 1, 2, 3, 4

	<string>	The string must be no more than 8 characters and only contain alphanumeric characters in addition to period, dash and underscore characters. The string must be enclosed in double quotes, "string".
Return parameter	<string>	Returns the label for the selected reference waveform. No return indicates that there has not been a file label assigned for the selected reference waveform.

Example1 :REF1:LABel "REF1_lab"
Sets the REF1 label as "REF1_lab".

Example2 :REF1:LABel?
REF1_lab

:REF<X>:LABel:DISPlay  

Description Turns the label on/off for the selected reference waveform or returns its status.

Syntax :REF<X>:LABel:DISPlay { OFF | ON | ? }

Related commands :REF<X>:LABel

Parameter	<X>	Reference waveform 1, 2, 3, 4
	OFF	Turns the file label off for the selected reference waveform.
	ON	Turns the file label on for the selected reference waveform.

Return parameter Returns the status of the file label for the selected reference waveform (ON, OFF).

Example :REF1:LABel "REF1"
:REF1:LABel:DISPlay ON
:REF1:LABel:DISPlay?

ON

Sets the label for reference waveform 1 to "REF1" and then turns the label display on. The query return shows that the label is on.

Set →

→ Query

:BUS<x>:LABel

Description	Sets or returns the file label for the bus.	
Syntax	:BUS<x>:LABel {<string> ?}	
Related commands	:BUS<x>:LABel:DISPlay	
Parameter	<x>	1 or 2, indicating decoding 1 or 2
	<string>	The string must be no more than 8 characters and only contain alphanumeric characters in addition to period, dash and underscore characters. The string must be enclosed in double quotes, "string".
Return parameter	<string>	Returns the label for the bus. No return indicates that there has not been a file label assigned for bus.
Example1	:BUS1:LABel "Bus" Sets the bus label as "Bus".	
Example2	:BUS1:LABel? Bus	

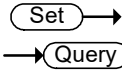

:BUS<x>:LAbel:DISPlay

Description	Turns the label on/off for the bus or returns its status.	
Syntax	:BUS1:LAbel:DISPlay { OFF ON ? }	
Related commands	:BUS<x>:LAbel	
Parameter	<x>	1 or 2, indicating decoding 1 or 2
	OFF	Turns the file label off for the bus.
	ON	Turns the file label on for the bus.
Return parameter	Returns the status of the file label for the bus (ON, OFF).	

DVM Commands

:DVM:STATE
 Set →
 Query

Description	Sets or queries the DVM state to on or off.	
Syntax	:DVM:STATE {OFF ON ? }	
Related commands	:DVM:SOURce :DVM:MODE	
Parameter/ Return parameter	OFF	Turns the DVM off.
	ON	Turns the DVM on.
Example	:DVM:STATE ON Turns the DVM state on.	

:DVM:SOURce
 Set →
 Query

Description	Sets or queries the source of the DVM.	
Syntax	:DVM:SOURce {CH1 CH2 CH3 CH4 ?}	
Related commands	:DVM:STATE :DVM:MODE	
Parameter/ Return parameter	CH1~CH4	Channel 1 to 4.
Example	:DVM:SOURce CH1 Sets the DVM source to channel 1.	

:DVM:MODE
 Set →
 Query

Description	Sets or queries the DVM mode.	
Syntax	:DVM:MODE { ACRMS ACDCRMS DC ?}	

Related commands	:DVM:SOURce	
	:DVM:STATE	
Parameter/Return parameter	OFF	Disable DVM function.
	Other Parameters	Sets the mode to DC Turn on DVM function and set the corresponding mode.
Example	:DVM:MODE AC RMS Sets the DVM mode to AC RMS.	

:DVM{RESET} (Set) →

Description	Set DVM to initialization state.	
Syntax	:DVM {RESET}	
Example	:DVM RESET Set DVM to initialization state.	

:DVM:STATistics RESet (Set) →

Description	Reset DVM statistics function.162	
Syntax	:DVM:STATistics RESet	
Example	:DVM:STATistics RESet Reset DVM statistics function.	

:DVM:STATistics:MAXimum → (Query)

Description	Query statistics maximum.	
Syntax	:DVM:STATistics:MAXimum?	
Example	:DVM:STATistics:MAXimum? :DVM:STATISTICS:MAXIMUM 243.0222E+9 Query statistics maximum.	

:DVM:STATistics:MINIum → Query

Description	Query statistics minimum.
Syntax	:DVM:STATistics:MINIum?
Example	:DVM:STATistics:MINIum? :DVM:STATISTICS:MINIMUM 204.5778E+9 Query statistics minimum.

:DVM:STATistics:{AVG|AVERage} → Query

Description	Query statistics average.
Syntax	:DVM:STATistics:{AVG AVERage}?
Example	:DVM:STATistics:AVERage ? :DVM:STATISTICS:AVERAGE 234.1950E+9 Query statistics average

Set →
 → Query

:DVM:ALARm:MODE

Description	Query or set the alarm mode of DVM function.	
Syntax	:DVM:ALARm:MODE {OFF ON BEEP} :DVM:ALARm:MODE?	
Parameter/ Return parameter	OFF	Disable alarm.
	ON	Enable alarm.
	BEEP	Turn on the alarm and activate the buzzer.
Example	:DVM:ALARm:MODE ON Set DVM alarm mode to ON	

Set →
 → Query

:DVM:ALARm:HIGHLimit

Description	Query or set the alarm upper limit value of DVM function.	
Syntax	:DVM:ALARm:HIGHLimit <NR3> :DVM:ALARm:HIGHLimit?	
Parameter/ Return parameter	<NR3>	Default unit is V.
Example 1	:DVM:ALARm:HIGHLimit 1 Set alarm upper limit value to 1V.	
Example 2	:DVM:ALARm:HIGHLimit? > 1.0000 Query alarm upper limit value.	

Set →
 → Query

:DVM:ALARm:LOWLimit

Description	Query or set the alarm lower limit value of DVM function.	
Syntax	:DVM:ALARm:LOWLimit <NR3> :DVM:ALARm:LOWLimit?	

Parameter/ Return parameter <NR3> Default unit is V.

Example 1 :DVM:ALARm:LOWLimit 1
Set alarm lower limit value to 1V.

Example 2 :DVM:ALARm:HIGHLimit?
> 1.0000
Query alarm lower limit value.

Set →

→ Query

:DVM:ALARm:WHEN

Description Query or set the alarm limit conditions of DVM function.

Syntax :DVM:ALARm:WHEN {INSLimit|OUTLimit}
:DVM:ALARm:WHEN?

Parameter INSLimit Inside Limit.
OUTLimit Outside Limit.

Example :DVM:ALARm:WHEN OUTLimit
Set alarm limit condition to outlimit.

:DVM:VALue

→ Query

Description Returns the measurement value of the selected mode.

Syntax :DVM:VALue?

Related commands :DVM:SOURce
:DVM:STATE
:DVD:MODE

Return parameter Returns the measurement value as <NR3>.

Example :DVM:VALue?
>8.410E-04
Returns the measurement.

AWG Commands

:AWG<x>:AMPlitude (Set) →
→ (Query)

Description	Sets or returns the waveform amplitude.	
Syntax	:AWG<x>:AMPlitude {<NRf> ?}	
Related command	:AWG<x>:OUTPut:LOAd:IMPEDance	
Parameter/ Return parameter	<x> <NRf>	Channel number 1~2. Amplitude in Volts. (50Ω impedance 0.1~2.5V) (High Z impedance 0.2~5V)
Example	:AWG1:AMP 1	

:AWG<x>:FREQuency (Set) →
→ (Query)

Description	Sets or returns the waveform frequency.	
Syntax	:AWG<x>:FREQuency {<NRf> ?}	
Parameter/ Return parameter	<x>	Channel number 1~2.
	<NRf>	Frequency in Hertz.
Example	:AWG1:FREQ 2000	

:AWG<x>:FUNCTion

Set →

→ Query

Description	Sets or returns the type of waveform.	
Syntax	:AWG<x>:FUNCTion {ARBitrary SINE SQUAre PULSe RAMP DC NOISe BUTTERWorth COMBin CPulse ROUNDShalf BANDLimited BLASEIWave CHEBYSHEV1 CHEBYSHEV2 DAMPEDOsc DUALTone BESSEL BESSELY LOG X2 X3 LFPulse TENS1 EOG COSH COT COTH COTHCon CSC CSCCon CSCPro CSCH CSCHCon ?}	
Parameter/ Return parameter	<x>	Channel number 1~2.
	ARBitrary	Arbitrary waveform
	SINE	Sine waveform
	SQUAre	Square waveform
	PULSe	Pulse waveform
	RAMP	Ramp waveform
	DC	DC waveform
	BUTTERWorth	BUTTERWorth waveform
	COMBin	COMBin waveform
	CPulse	CPulse waveform
	ROUNDShalf	ROUNDShalf waveform
	BANDLimited	BANDLimited waveform
	BLASEIWave	BLASEIWave waveform
	CHEBYSHEV1	CHEBYSHEV1 waveform

CHEBYSHEV2	CHEBYSHEV2 waveform
DAMPEDOsc	DAMPEDOsc waveform
DUALTone	DUALTone BESSEL waveform
BESSEL	
BESSELY	BESSELY aveform
LOG	LOG waveform
X2	X2 waveform
X3	X3 waveform
LFPulse	LFPulse waveform
TENS1	TENS1 waveform
EOG	EOG waveform
COSH	COSH waveform
COT	COT waveform
COTH	COTH waveform
COTHCon	COTHCon waveform
CSC	CSC waveform
CSCCon	CSCCon waveform
CSCPro	CSCPro waveform
CSCH	CSCH waveform
CSCHCon	CSCHCon waveform
NOISe	Noise waveform

Example :AWG1:FUNC?
>SINE

:AWG<x>:OFFSet



Description	Sets or returns the waveform offset.	
Syntax	:AWG<x>:OFFSet {<NRF> ?}	
Parameter/ Return parameter	<x>	Channel number 1~2.
	<NRF>	Offset in Volts.
Example	:AWG1:OFFS	

:AWG<x>:OUTPut:LOAD:IMPEDance



Description	Sets or returns the output termination	
Syntax	:AWG<x>:OUTPut:LOAD:IMPEDance {FIFTy HIGHZ ?}	
Parameter/ Return parameter	<x>	Channel number 1~2
	FIFTy	50 Ohm output termination
	HIGHZ	High Z output termination
Example	:AWG1:OUTP:LOA:IMPED HIGHZ Sets the output termination of channel 1 to high impedance.	

:AWG<x>:OUTPut:STATE



Description	Sets or returns the channel output state.	
Syntax	:AWG<x>:OUTPut:STATE {OFF ON ?}	
Parameter/ Return parameter	<x>	Channel number 1~2
	OFF	Turns the channel output off
	ON	Turns the channel output on
Example	:AWG1:OUTP:STATE OFF Turns the channel 1 output off.	

:AWG<x>:PHase (Set) →
→ (Query)

Description	Sets or returns the channel phase.	
Syntax	:AWG<x>:PHase {<NRf> ?}	
Parameter/ Return parameter	<x>	Channel number 1~2.
	<NRf>	Phase in degree -180~180°
Example	:AWG1:PHA 45 Sets the channel 1 phase to 45°.	

:AWG<x>:PULSe:DUTYcycle (Set) →
→ (Query)

Description	Sets or returns the pulse duty cycle.	
Syntax	:AWG<x>:PULSe:DUTYcycle {<NRf> ?}	
Parameter/ Return parameter	<x>	Channel number 1~2.
	<NRf>	Duty cycle in percentage 0.2~99.8%
Example	:AWG1:PULS:DUTY 50 Sets the channel 1 pulse duty cycle to 50%.	

:AWG<x>:RAMP:SYMmetry (Set) →
→ (Query)

Description	Sets or returns the ramp symmetry.	
Syntax	:AWG<x>:RAMP:SYMmetry {<NRf> ?}	
Parameter/ Return parameter	<x>	Channel number 1~2.
	<NRf>	Symmetry of the ramp waveform 0~100%
Example	:AWG1:RAMP:SYM 15 Sets the channel 1 ramp symmetry to 15%.	

:AWG<x>:MODulation:STATE (Set) →
→ (Query)

Description	Sets or returns the modulation state.	
Syntax	:AWG<x>:MODulation:STATE {OFF ON ?}	
Parameter/ Return parameter	<x>	Channel number 1~2.
	OFF	Sets the modulation to off.
	ON	Sets the modulation to on.
Example	:AWG1:MOD:STATE ON Turns the modulation on for channel 1.	

:AWG<x>:MODulation:TYPe

Description	Sets or returns the type of modulation.	
Syntax	:AWG<x>MODulation:TYPe {AM FM FSK ?}	
Parameter/ Return parameter	<x>	Channel number 1~2.
	AM	Sets a AM modulation.
	FM	Sets a FM modulation.
	FSK	Sets a FSK modulation.
Example	:AWG1:MOD:TYPE AM Sets a AM modulation for channel 1.	

:AWG<x>:MODulation:AM:DEPth (Set) →
→ (Query)

Description	Sets or returns the AM modulation depth.	
Syntax	:AWG<x>:MODulation:AM:DEPth {<NRF> ?}	
Parameter/ Return parameter	<x>	Channel number 1~2.
	<NRF>	AM depth in percentage 0~120%.
Example	:AWG1:MOD:AM:DEP? >1.20000e+02	

:AWG<x>:MODulation:AM:FREQ (Set) →
→ (Query)

Description	Sets or returns the AM modulation frequency.	
Syntax	:AWG<x>:MODulation:AM:FREQ {<NRF> ?}	
Parameter/ Return parameter	<x>	Channel number 1~2.
	<NRF>	AM frequency in Hertz.
Example	:AWG1:MOD:AM:FREQ 1000 Sets the AM frequency to 1kHz.	

:AWG<x>:MODulation:AM:SHApe (Set) →
→ (Query)

Description	Sets or returns the shape of the AM modulation.	
Syntax	:AWG<x>:MODulation:AM:SHApe {SINE SQUare RAMP NOISe ?}	
Parameter/ Return parameter	<x>	Channel number 1~2.
	SINE	Sine wave shape.
	SQUare	Square wave shape.
	RAMP	Ramp wave shape.
	NOISe	Noise wave shape.

Example :AWG1:MOD:AM:SHA RAMP
 Sets a ramp shape to the AM modulating waveform.

:AWG<x>:MODulation:FM:DEV Set →
→ Query

Description Sets or returns the deviation of the FM modulation.

Syntax :AWG<x>:MODulation:FM:DEV {<NRf> | ?}

Parameter/ Return parameter	 <x> <NRf>	 Channel number 1~2. Frequency deviation in Hertz.
--------------------------------	------------------	--

Example :AWG1:MOD:FM:DEV?
 >2.000000000e+02

:AWG<x>:MODulation:FM:FREQ Set →
→ Query

Description Sets or returns the frequency of the FM modulation.

Syntax :AWG<x>:MODulation:FM:FREQ {<NRf> | ?}

Parameter/ Return parameter	 <x> <NRf>	 Channel number 1~2. Frequency in Hertz.
--------------------------------	------------------	--

Example :AWG1:MOD:FM:FREQ 1000
 Sets the frequency of the FM modulating waveform to 1kHz.

:AWG<x>:MODulation:FM:SHApe Set →
→ Query

Description Sets or returns the shape of the FM modulation.

Syntax :AWG<x>:MODulation:FM:SHApe {SINE | SQUare | RAMP | NOISe | ?}

Parameter/ Return parameter	 <x> SINE SQUare	 Channel number 1~2. Sine wave shape. Square wave shape.
--------------------------------	---------------------------	---

RAMP	Ramp wave shape.
NOISe	Noise wave shape.

Example :AWG1:MOD:FM:SHA SINE
Sets a sine shape to the FM modulation.

:AWG<x>:MODulation:FSK:FREQ Set →
→ Query

Description Sets or returns the hop frequency of the FSK modulation.

Syntax :AWG<x>:MODulation:FSK:FREQ {<NRF> | ?}

Parameter/ Return parameter	<x>	Channel number 1~2.
	<NRF>	Frequency in Hertz.

Example :AWG1:MOD:FSK:FREQ 2000000
Sets the FSK hop frequency to 2MHz.

:AWG<x>:MODulation:FSK:RATE Set →
→ Query

Description Sets or returns the FSK modulation rate.

Syntax :AWG<x>:MODulation:FSK:RATE {<NRF> | ?}

Parameter/ Return parameter	<x>	Channel number 1~2.
	<NRF>	Frequency in Hertz.

Example :AWG1:MOD:FSK:RATE 100000
Sets the FSK rate to 100kHz.

:AWG<x>:SWEep:TYPe Set →
→ Query

Description Sets or returns the sweep mode type.

Syntax :AWG<x>:SWEep:TYPe {LINEAR | LOG | ?}

Parameter/ Return parameter	<x>	Channel number 1~2.
	LINEAR	Sets the sweep mode to linear.
	LOG	Sets the sweep mode to logarithmic.

Example :AWG1:SWE:TYP LIN
Sets the sweep mode to linear for channel 1.

:AWG<x>:SWEep:START (Set) →
→ (Query)

Description Sets or returns the start frequency of the sweep mode.

Syntax :AWG<x>:SWEep:START {<NRf> | ?}

Parameter/ Return parameter	<x>	Channel number 1~2.
	<NRf>	Start frequency in Hertz.

Example :AWG1:SWE:START 1000
Sets the sweep mode start frequency to 1kHz.

:AWG<x>:SWEep:STOP (Set) →
→ (Query)

Description Sets or returns the stop frequency of the sweep mode.

Syntax :AWG<x>:SWEep:STOP {<NRf> | ?}

Parameter/ Return parameter	<x>	Channel number 1~2.
	<NRf>	Stop frequency in Hertz.

Example :AWG1:SWE:STOP 500000
Sets the sweep mode stop frequency to 500kHz.

:AWG<x>:SWEep:TIME (Set) →
→ (Query)

Description Sets or returns the sweep time.

Syntax :AWG<x>:SWEep:TIME {<NRf> | ?}

Parameter/ Return parameter	<x>	Channel number 1~2.
	<NRf>	Sweep time in seconds.

Example :AWG1:SWE:TIM 6.500e-01
Sets the sweep time to 650ms.

Set →
→ Query

:AWG<x>:SWEep:SPAN

Description	Alternatively to setting the start and stop frequencies, the span and center frequency can be set.	
Syntax	:AWG<x>:SWEep:SPAN {<NRf> ?}	
Parameter/ Return parameter	<x>	Channel number 1~2.
	<NRf>	Span of the sweep in Hertz.
Example	:AWG1:SWE:SPAN 1100 Sets the span of the sweep to 1.1kHz.	

Set →
→ Query

:AWG<x>:SWEep:CENTer

Description	Alternatively to setting the start and stop frequencies, the span and center frequency can be set.	
Syntax	:AWG<x>:SWEep:CENTer {<NRf> ?}	
Parameter/ Return parameter	<x>	Channel number 1~2.
	<NRf>	Center frequency of the sweep in Hertz.
Example	:AWG1:SWE:CENT 550 Sets the center frequency of the sweep to 550Hz.	

FRA Commands

:FRA:RUN



Description Runs the FRA function or returns the FRA state.

Syntax :FRA:RUN
 :FRA:RUN?

Example :FRA:RUN
 FRA starts.

:FRA:STOP



Description Stops the FRA function or returns the FRA state.

Syntax :FRA:STOP
 :FRA:STOP?

Example :FRA:STOP
 FRA stops.

:FRA:FREQuency:STARt

Set →

→ Query

Description	Sets or returns the start frequency for FRA.	
Syntax	:FRA:FREQuency:STARt {<NRf>} :FRA:FREQuency:STARt?	
Parameter	<NRf>	Sets the frequency to use. (Range:20Hz~25MHz)
Example	:FRA:FREQuency:STARt 100 Sets the start frequency as 100Hz.	

Set →

→ Query

:FRA:FREQuency:STOP

Description	Sets or returns the stop frequency for FRA.	
Syntax	:FRA:FREQuency:STOP {<NRf>} :FRA:FREQuency:STOP?	
Parameter	<NRf>	Sets the frequency to use. (Range:20Hz~25MHz)
Example	:FRA:FREQuency:STOP 500 Sets the start frequency as 500Hz.	

Set →

→ Query

:FRA:POINt

Description	Sets or returns the number of processing points in a decade.	
Syntax	:FRA:POINt {<NR1>} :FRA:POINt?	
Parameter	<NR1>	The number of points in a decade. (Range:10, 15, 30, 45, 90)
Example	:FRA:POINt 15 Sets the number of processing points as 15 in a decade.	

:FRA:DATA

→ Query

Description	Shows the detailed information of FRA settings and results.
Syntax	:FRA:DATA?
Example	:FRA:DATA? Shows the FRA result's detail.

:FRA:SAVETOCsv

Set →

Description Saves the FRA result as a CSV file.

Syntax :FRA:SAVETOCsv

Example :FRA: SAVETOCsv
Saves results as CSV file.

:FRA:STATe

→ Query

Description Query or turn on/ off the FRA function.

Syntax :FRA:STATe {ON|OFF}
:FRA:STATe?

Parameter	ON	Turn on the FRA. (No work when PWR function running)
	OFF	Turn off the FRA.

Example :FRA:STATe ON
:FRA:STATe?
ON