

Digital Power Meter

GPM-8320-60/8330-60

USER MANUAL

Rev. A



ISO-9001 CERTIFIED MANUFACTURER

GW INSTEK

This manual contains proprietary information, which is protected by copyright. All rights are reserved. No part of this manual may be photocopied, reproduced or translated to another language without prior written consent of Good Will company.

The information in this manual was correct at the time of printing. However, Good Will continues to improve products and reserves the rights to change specification, equipment, and maintenance procedures at any time without notice.

Good Will Instrument Co., Ltd.
No. 7-1, Jhongsing Rd., Tucheng Dist., New Taipei City 236, Taiwan.

Table of Contents

SAFETY INSTRUCTIONS	5
GETTING STARTED	10
Characteristics	11
Appearance	15
Set Up	25
BASIC SETTING	27
Setting up measurement range	29
Setting up measurement status	33
Setting up System status	70
MEASUREMENT AND OTHER FUNCTIONS	80
Measurement function	81
Other functions	94
Integration measurement function	97
Graph measurement function	107
DIGITAL I/O / DA12	125
Digital I/O / DA12 Overview	126
External Remote Control	128
DA12 Output Function	129
REMOTE CONTROL	134
Configure Remote Control Interface	135
Configure EOL Character	142
Return to Local Control	142
COMMAND OVERVIEW	143
Command Syntax	143
Command List	147
APPENDIX	229

Specifications	230
Status system	240
Dimensions	244
Certificate Of Compliance	245
Power measurement	246

SAFETY INSTRUCTIONS

This chapter contains important safety instructions that you must follow during operation and storage. Read the following before any operation to ensure your safety and to keep the instrument in the best possible condition.

Safety Symbols

These safety symbols may appear in this manual or on the instrument.



WARNING

Warning: Identifies conditions or practices that could result in injury or loss of life.



CAUTION

Caution: Identifies conditions or practices that could result in damage to the GPM-8320-60/8330-60 or to other properties.



DANGER High Voltage



Attention Refer to the Manual



Protective Conductor Terminal



Earth (ground) Terminal



Do not dispose electronic equipment as unsorted municipal waste. Please use a separate collection facility or contact the supplier from which this instrument was purchased.

Safety Guidelines

General Guideline • Make sure that the voltage input level does not exceed AC 600 V.



CAUTION

- Make sure the current input level does not exceed 70 A.
- Do not place any heavy object on the instrument.
- Avoid severe impact or rough handling that can lead to damaging the instrument.
- Do not discharge static electricity to the instrument.
- Use only mating connectors, not bare wires, for the terminals.
- Do not perform measurement at the source of a low-voltage installation or at building installations (Note below).
- Do not disassemble the instrument unless you are qualified as service personnel.
- Make sure that the COM terminal to earth is limited to 600 Vpk.
- Remove all test leads before disconnecting the mains power cord from the socket.
- If the equipment is used in a manner not specified by the manufacturer, the protection provided by the equipment may be impaired.
- The device should be placed in a place where the plug connected to it can be removed easily.
- Interface: USB / RS232 / LAN2/ Mini GPIB / Digital IO DA12 ports are only to be connected to the circuits which are separated from mains supply by double / reinforce insulation.

(Note) EN 61010-1 specifies the measurement categories and their requirements as follows. The GPM-8320-60/8330-60 falls under category II 600V.

- Measurement category IV is for measurement performed at the source of low-voltage installation.
- Measurement category III is for measurement performed in the building installation.
- Measurement category II is for measurement performed on the circuits directly connected to the low voltage installation.

Power Supply



WARNING

- AC Input voltage: AC 100 V to 240 V 50 Hz / 60 Hz
- The power supply voltage should not fluctuate more than 10%.
- Connect the protective grounding conductor of the AC power cord to an earth ground, to avoid electrical shock.

Cleaning the Instrument

- Disconnect the power cord before cleaning.
- Use a soft cloth dampened in a solution of mild detergent and water. Do not spray any liquid.
- Do not use chemicals containing harsh material such as benzene, toluene, xylene, and acetone.

Operation Environment

- Location: Indoor, no direct sunlight, dust free, almost non-conductive pollution (Note below)
- Temperature: 0 °C to 40 °C
- Humidity: < 30 °C: < 80%RH(non-condensing);
30 °C to 40 °C:< 70% RH(non-condensing);
> 40 °C: < 50% RH (non-condensing)
- Altitude: < 2000 m
- Overvoltage category: OVC II

(Note) EN 61010-1 specifies the pollution degrees and their requirements as follows. The GPM-8320-60/8330-60 falls under degree 2.

- Pollution refers to “addition of foreign matter, solid, liquid, or gaseous (ionized gases), that may produce a reduction of dielectric strength or surface resistivity”.
- Pollution degree 1: No pollution or only dry, non-conductive pollution occurs. The pollution has no influence.
- Pollution degree 2: Normally only non-conductive pollution occurs. Occasionally, however, a temporary conductivity caused by condensation must be expected.
- Pollution degree 3: Conductive pollution occurs, or dry, non-conductive pollution occurs which becomes conductive due to condensation which is expected. In such conditions, equipment is normally protected against exposure to direct sunlight, precipitation, and full wind pressure, but neither temperature nor humidity is controlled.

Storage
environment

- Location: Indoor
- Temperature: -40 °C to 70 °C
- Humidity: < 90% RH(non-condensing)

Disposal



Do not dispose this instrument as unsorted municipal waste. Please use a separate collection facility or contact the supplier from which this instrument was purchased. Please make sure discarded electrical waste is properly recycled to reduce environmental impact.

GETTING STARTED

This chapter describes the GPM-8320-60/8330-60 in a nutshell, including accessories, package contents, its main features and front / rear panel introduction.

Characteristics	11
Accessories.....	13
Package Contents	14
Appearance	15
Front Panel	15
Main Display Overview	18
Rear Panel	21
Set Up	25
Power Up.....	25
Connect the wires to the GPM-8320-60/8330-60	26

Characteristics

The GPM-8320-60/8330-60 is a high-precision, programmable power meter for using increase 3-phase simultaneous measurement, for high power, such as motors, etc.. It equips with a color TFT-LCD screen and also multiple graph displays which are very convenient for reading the measurement results. The GPM-8320-60/8330-60 has become a reliable power measurement instruments because of its simple operation, excellent performance, user-friendly graph displays and automatic measurement interface.

Operation	<ul style="list-style-type: none">• Press the buttons on the front panel to easily turn on the GPM-8320-60/8330-60 measurement function. All settings and measurements results are displayed on the 5-inches TFT-LCD screen panel for easy use of each function.• Standard display mode: 2 main measurement results and 8 secondary measurement results are displayed in this screen.• Simple display mode: 4 major measurement results are displayed in this screen.
Performance	<ul style="list-style-type: none">• 7 selectable voltage ranges available from 15 V to 1000 V with 0.1% of reading + 0.05% of range.• 6 selectable current ranges available from 1 A to 60 A with 0.1% of reading + 0.05% of range.• It can even measure the voltage of abnormal wave of CF 3. The half-range CF is up to 6 or 6A.• It can even measure the current of abnormal wave of CF 3. The half-range CF is up to 6 or 6A.• Total harmonic distortion measurement.• 50-orders harmonic test and analysis function.• Graph display for measurement results including harmonic orders distribution.• Plug-in USB disk data store function including

	log and screenshot.
	<ul style="list-style-type: none">• Auto range function for integration measurement.
Features	<ul style="list-style-type: none">• Full five-digit measurement.• Voltage measurement range: 15 V to 1000 V or automatic switching• Current measurement range: 1 A to 60 A or automatic switching• 3-channel simultaneous display screen and total calculation value screen• Maximum accuracy of 0.1% of reading + 0.05% of range• 2 main measurement readings and 8 minor measurement readings are displayed in the screen of standard display mode.• 4 main measurement readings are displayed in the screen of simple display mode.• Added stand-alone display of total harmonic distortion measurement function (50 steps)• Test bandwidth of voltage and current: DC ~ 100 kHz.• Selectable boot settings (Previous / Default)• Waveform display up to 10 kHz along with Harmonic bar and list table
Interface	<ul style="list-style-type: none">• Interface: USB/ RS232/ LAN/ Mini GPIB/Digital IO DA12
Application	<ul style="list-style-type: none">• It can be applied to production test such as power supplies, transformers, motors, electrical equipment.

Accessories

Standard Accessories			
Standard Accessories	Part number	Description	Q'ty
	82GW1SAFE0M01	Safety Instruction Sheet	1
	Region dependent	Power Cord	1
	GTL-209	Test leads (For GPM-8330-60)	3
	GTL-209	Test leads (For GPM-8320-60)	2
	GTL-212A	Test leads (For GPM-8330-60)	3
	GTL-212A	Test leads (For GPM-8320-60)	2
	GPM-002	Terminal Cover	1
Optional Accessories			
Optional Accessories	Part number	Description	
	GTL-234	RS232C cable	
	GTL-246	USB cable	
	GTL-248	GPIB cable	
	GCP-300	Current Probe	
	GRA-452	Rack Adapter Panel (19", 3U)	
Option			
Option	Name	Description	
	GPM-DA12	GPIB+DA12 interface card (Factory installed)	

Package Contents

Check the contents before using the instrument.

Opening the box

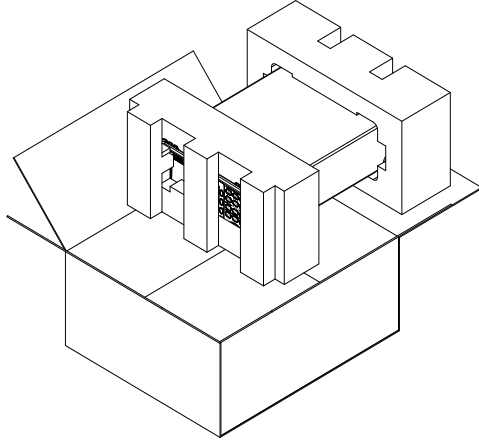

Contents
(single unit)



- Main unit
- Test lead sets
(depends on model)
- Terminal Cover
- Power cord x1 (region dependent)
- User manual CD
- Safety instruction sheet

Appearance

Front Panel

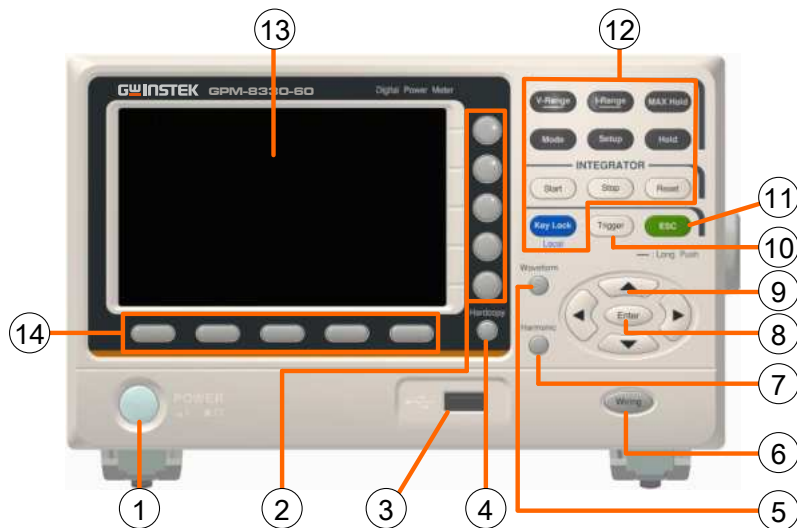







GPM-8320-60/8330-60



1 Power Key  Turns On  or Off  the main power. For the power up sequence, see page 25.

2 Soft keys  The 5 soft keys have varied functions from the OSD (On-Screen Display) options, individually, per different settings.

3 USB Host Port  Connects with USB flash drive for data storage or screenshot.

-
- | | | | |
|-------|---------------|---|---|
| 4 | Hardcopy key |  | Captures the current screenshot or saves the data log for reading. For details, refer to page 65. |
| <hr/> | | | |
| 5 | Waveform key |  | It can simultaneously display voltage, current and power waveforms. Display one channel at a time. |
| <hr/> | | | |
| 6 | Wiring key |  | There are 1P3W, 3P3W, 3P4W, 3V3A wiring more available. |
| <hr/> | | | |
| 7 | Harmonic key |  | Setting parameters of 3 phases can display 50-order harmonic values or graphics. |
| <hr/> | | | |
| 8 | Enter Key |  | This button is used to enter the menu, confirm the settings and switch between the standard display mode and simple display mode (no function table and display icon). See page 95. |
| <hr/> | | | |
| 9 | Arrow Keys |  | This four arrow keys are used to edit the parameters, browse the menu system and select the parameter range. |
| <hr/> | | | |
| 10 | Trigger key |  | Activates the Trigger function. See page 95. |
| <hr/> | | | |
| 11 | ESC Key |  | Press this button to cancel the current setting. The cursor returns to the default position or return to the previous menu according to the situation. See page 96. |
| <hr/> | | | |
| 12 | Function Keys |  | V-Range key, up/down arrow keys and Enter key can be used together to select a voltage range or auto range measurement mode. Also, press and hold the V-Range key to toggle between manual and auto range setting. See page 29. |



I-Range key, up/down arrow keys and Enter key can be used together to select a current range or auto range measurement mode. Also, press and hold the I-Range key to toggle between manual and auto range setting. See page 29.



Press this button to display the maximum measurement reading. See page 95.

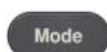

Press this key to select measure mode (DC/AC/AC+DC/V-MEAN). See page 96.



Press this key to enter the measurement settings menu. See page 33.



Press this key to switch window and stop refreshing. See page 95.

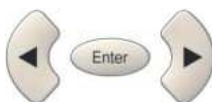

Use the left and right arrow keys to select Integrator mode, and press Enter button to enter the time integrator function. See page 97.



Press this key to toggle to key lock. In Remote control mode, press this button to switch to local mode. See page 96.

13 LCD

14 F1~F5 function keys



Main Display Overview

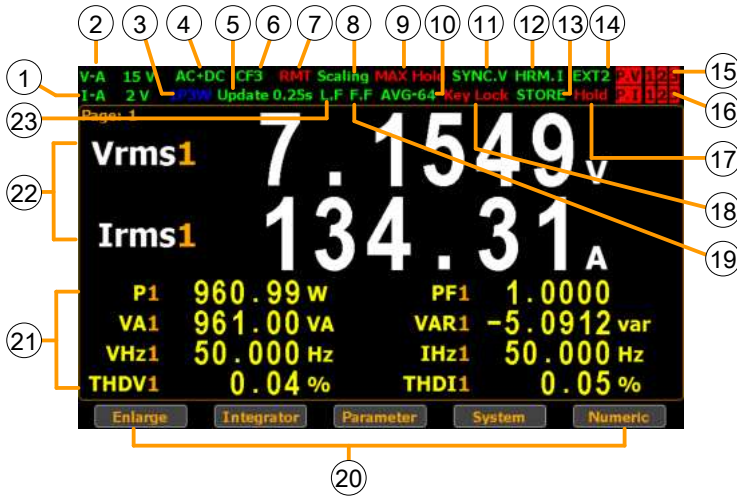

No.	Item	Status icon	Description
1	Voltage Range	V-A 15 V	Voltage measurement range. Example here range is 15 V. V-Auto means that Voltage Auto Range is turned on.
2	Current Range	I-A 2 A	Current measurement range. Example here range is 2 A. I-Auto means that Current Auto Range is turned on.
		Note	If status icon of Voltage Range or Current Range lit in red means that the range selected is inappropriate or are restricted. Please select another range again.
3	Wiring mode	1P3W	This icon displays present wiring mode (1P3W, 3P3W, 3P4W, 3V3A).

4	Mode	AC+DC	Measurement mode (AC, DC, AC+DC, V-MEAN)
5	Date Update Rate	Update 0.25 s	Data update rate (0.1/0.25/0.5/1/2/5/10/20/Auto)
6	Crest Factor	CF3	Crest Factor (3/6/6A)
7	Remote	RMT	Remote control mode (On/Off)
8	Ratio State	Scaling	The icon will lit when any external magnification (voltage, current, power) is activated,
9	Maximum Hold	MAX Hold	Retain and display the maximum measurement reading.
10	Average	AVG-8	Average number of sampling (8/16/32/64)
11	Sync Source	SYNC.V	Synchronization source (V/I/Off)
12	Harmonic Calculation	HRM.I	Harmonic calculation method (IEC/CSA/Off)
13	Measure Storage	STORE	Measured date storage (On/Off)
14	External Input	EXT1	External signal input function (Ext1/Ext2/Off)
15	Peak Voltage	P.V	The voltage exceeds the measurement range
16	Peak Current	P.I	The current exceeds the measurement range
17	Display Hold	Hold	Retain and display the current measurement reading.
18	Keyboard Lock	Key Lock	Lock Key button
19	Frequency Filter	F.F	Frequency filters (On/Off)

20	Secondary menus	<p>Display secondary function menu</p> <p>To navigate the secondary function menu, use left and right arrow keys alternately. The arrow keys are loopback, which means, for example, when it stops at Graph, press the right arrow key to move to Enlarge in a promptly loopback manner.</p> <ul style="list-style-type: none"> • Enlarge This function key is used to switch display of measurement result from 2 major plus 8 minor to 4 major ones. • Integrator This function key is used to set up integrator measurement parameters and execute integrator measurement function. • Parameter This function key is used set up measurement parameters. • System This function key is used to enter the system setting and system configuration screens. • Graph This function key is used to set up graph measurement settings and execute measurement in the intuitive graph displays.
<hr/>		
21	Simple Display Mode	Display the measurement result of 4 major measurement parameters
<hr/>		
22	Standard Display Mode	Display the measurement result of 2 major and 8 minor measurement parameters
<hr/>		
23	Line Filter	L.F Voltage and current filters (On/Off)

Rear Panel

GPM-8330-60

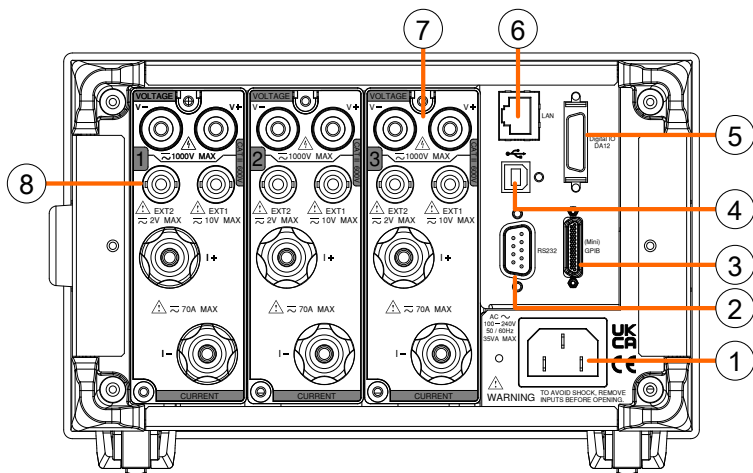

GPM-8320-60

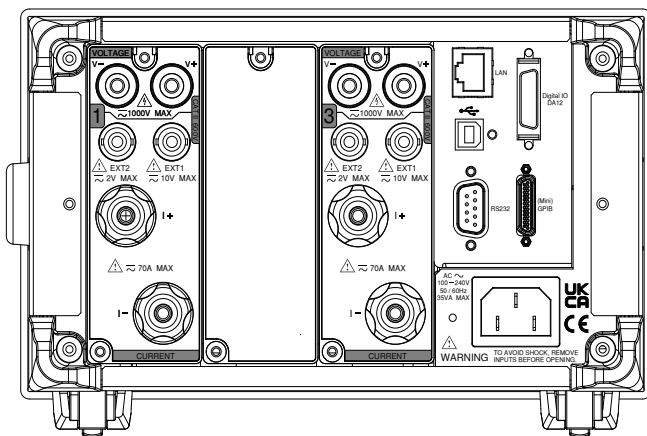

GPM-8330-60 (without GPIB +DA 12 interface)

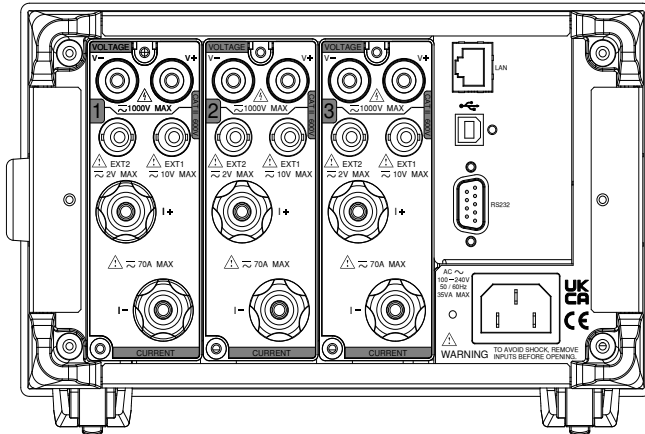

1 Power Cord Socket

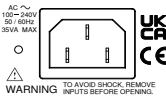

Connects the power cord.
AC 100 V to 240 V $\pm 10\%$,
50 Hz / 60 Hz

2 RS232 Connector



Accepts an RS-232C cable for remote control; DB-9 male connector. For remote control details, see page 136.

3 Mini GPIB Connector



Accepts an optional GPIB card for remote control. For GPIB details, see page 138.

4 USB Device Port



Accepts a USB device cable for remote control; Type B, female connector. For remote control details, see page 135.

5 Digital IO / DA12



Accepts a digital I/O cable for signal output; SCSI 26 pin, female connector. For digital I/O details, see page 126

6 LAN Port



Accepts a LAN for remote control. For remote control details, see page 140.

7 Voltage/Current input terminal

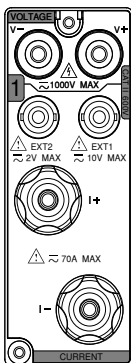

Voltage/Current input terminals is used to connect the main measurement signals. The number on the left side means the number of channel. There are 3 channels for GPM-8330-60 and 2 channels for GPM-8320-60.

8 External Input 1/2

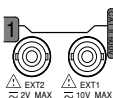

Connects output signal to the EXT1 terminal which receives up to 10 V, or the EXT2 terminal that receives at the maximum of 2 V. See page 57 for setting.



Warning

- Do not use damaged device. Before using the equipment, check its housing first to sure there is no any cracks. Do not operate this device in an environment containing explosive gases, steam or dust.
- The maximum measurable current and voltage are 1000 V and 70 A for voltage and current terminals of the rear panel of the GPM-8320-60/8330-60. Do not input exceeded voltage and current, otherwise it will burn the device.
- The maximum input voltage are 10 V and 2 V for EXT1 and EX2 terminals of the rear panel of the GPM-8320-60/8330-60. Do not input exceeded voltage, otherwise it will burn the device.
- Always use the supplied cable for connection.
- Before connecting the device, observe all the safety symbols marked on the device.
- Turn off the power to the device and the application system before connecting I/O terminals.
- Do not install replacement parts on the device or perform any unauthorized modifications.
- Do not use this device if the removable cover is removed or loosened.
- Do not connect any cables and terminals before performing self-test.
- Use only the power adapter supplied by the manufacturer to avoid accidental injury.
- Do not use this device for life support systems or any other equipment that has safety requirements.

Set Up

Power Up

Steps

1. Ensure the AC voltage is 100 V to 240 V.

2. Connect the power cord to the AC voltage input.

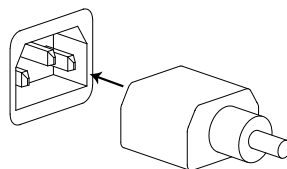

Note

Make sure the ground connector on the power cord is connected to a safety ground. This will influence the measurement accuracy.

3. Push to turn on the main power switch on the front panel.

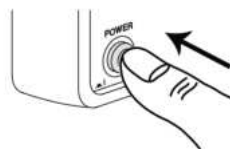

4. The display turns on and shows the last function that was used before the power was reset.

Connect the wires to the GPM-8320-60/8330-60

Background Two separate wires is used to connect the GPM-8320-60/8330-60, so voltage and current measurement are isolated and don't interfere with each other.

Connection diagram

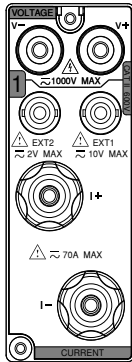

Description	V +	The positive voltage input (+), 1000V for input on the rear panel.
	V -	The negative voltage input (-), 1000 V for input on the rear panel.
	I +	The positive current input (+), 70 A for input on the rear panel.
	I -	The negative current input (-), 70 A for input on the rear panel.
	EXT1	The external 1 voltage input, 10 V for input on the rear panel.
	EXT2	The external 2 voltage input, 2 V for input on the rear panel.

BASIC SETTING

Setting up measurement range	29
Auto Range	31
Setting up measurement status	33
Setting up synchronization source	33
Setting up line filter	34
Setting up frequency filter	35
Setting up crest factor	36
Setting up auto-zero function	37
Setting up method of calculating harmonics	38
Setting up data update rate	40
Setting up measure storage	42
Setting up average function	44
Setting up the voltage and current skipping configuration	46
Setting up the skipping configuration for external ...	49
Setting up the Element for Ratio	52
Setting up the VT ratio state	53
Setting up the CT ratio state	54
Setting up the power ratio state	55
Setting up the external sensor input terminal	57
Saving and loading the setup parameters	59
Setting up the D/A output configuration	61
Setting up the hardcopy and log configuration	65
Setting up the MATH configuration	67
Setting up System status	70
System information screen	70

SYSTEM CONFIG1 screen.....	72
Setting up power on status	72
Setting up brightness.....	74
Setting up key sound	74
Setting up remote interface	75
SYSTEM CONFIG2 screen.....	77
Setting up SCPI identity	78
Setting up Numeric data Form.....	79

Setting up measurement range

To get the accurate measurement results, you should set an appropriate measurement range before you perform measurement task.

- Set voltage range
1. Press **V-Range** button. The V-Range field turns to bluish.
 2. Use up and down arrow keys to select the desired range.
 3. Press **Enter** button to confirm your selection.



- Available range
- | | |
|-----------------------|---|
| Crest Factor is 3: | AUTO, 15 V, 30 V, 60 V, 150 V, 300 V, 600 V and 1000 V |
| Crest Factor is 6/6A: | AUTO, 7.5 V, 15 V, 30 V, 75 V, 150 V, 300 V and 500 V |

- Set current range
1. Press **I-Range** button. The I-Range field turns to bluish.



- Use up and down arrow keys to select the desired range.



- Press **Enter** button to confirm your selection.



Available range

Crest Factor **AUTO, 1 A, 2 A, 5 A, 10 A, 20 A and 60 A**

Crest Factor **AUTO, 0.5 A, 1 A, 2.5 A, 5 A, 10 A and 6/6A: 30 A**



Note

When the measurement range is set manually, if the range status icon lights in green means that the measured value meets the setting range. On the contrary, If the range status icon lights in red means that the measured value doesn't meet the best setting range. In this case. It is better to switch to other range to get more accurate measurement results.



Note

The P.I status icon lights in red when the current measurement circuit detects that the measured value exceeds setting range by 3 folds (CF is set to 3) or 6 folds (CF is set to 6/6A).



Note

The P.V status icon lights in red when the voltage measurement circuit detects that the measured value exceeds setting range by 3 folds (CF is set to 3) or 6 folds (CF is set to 6/6A).

Auto Range

The range is automatically switched according to the voltage and current of input signal.

Range is shift up The range is shifted up when either of the following conditions is met.

- Vrms or Irms exceeds the measurement range by 130% at CF 3/6.
- Vrms or Irms exceeds the measurement range by 260% at CF 6A.
- The Vpk or Ipk value of the input signal exceeds the current setting range by 300% at CF 3.
- The Vpk or Ipk value of the input signal exceeds the current setting range by 600% at CF 6/6A.

Range is shift down The range is shifted down when all of the following conditions are met.

- Vrms or Irms is equal to or less than the measurement range by 30% at CF 3/6/6A.
- Vrms or Irms is equal to or less than the next lower measurement range by 125% at CF 3/6/6A.
- The Vpk or Ipk value of the input signal is equal to or less than the next lower measurement range by 300% at CF 3.
- The Vpk or Ipk value of the input signal is equal to or less than the next lower measurement range by 600% at CF 6/6A.

Example



To begin with, the measured Irms1 value is within the current range of I-A 1 A.







The measured Irms1 (1.3601 A) exceeds the I-A 1 A by 130%, so the range is shifted up to 2 A automatically.



The measured Irms1 (199.78 mA) is less than 30% of the I-A 1 A, so the range is shifted down to 0.5 A automatically.

Setting up measurement status

Setting up synchronization source



- | | | |
|-------|---|---|
| Steps | 1. Press Setup button. |  |
| | 2. Press Enter button. |  |
| | 3. Press down arrow key to move cursor to the Sync Source field. |  |
| | 4. Use soft keys to select and confirm the desired option. |  |



- | | | |
|--------|------------|--|
| Option | V | Select the voltage of signals as synchronization source. The SYNC.V status icon, for example, on the display lights up in green when V is selected for sync source. |
| | I | Select the current of signals as synchronization source. |
| | Off | Select the entire interval of data updating period as synchronization source. |

Default value **V**

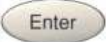
Setting up line filter





- | | | |
|-------|---|---|
| Steps | 1. Press Setup button. |  |
| | 2. Press Enter button. |  |
| | 3. Press down arrow key to move cursor to the Line Filter field. |  |
| | 4. Use soft keys to select and confirm the desired option. |  |



- | | | |
|--------|------------|---|
| Option | On | Turn on the line filter function, which is inserted into voltage and current measurement input circuits and affects voltage, current as well as power measurements without high frequency components included within measured values. The L.F status icon on the display lights up in green. |
| | Off | Turn off the line filter function. The cutoff frequency is 500 Hz. |

Default value **Off**





Setting up frequency filter

- | | | |
|-------|--|---|
| Steps | 1. Press Setup button. |  |
| | 2. Press Enter button. |  |
| | 3. Press down arrow key to move cursor to the Frequency Filter field. |  |
| | 4. Use soft keys to select and confirm the desired option. |  |



- | | | |
|---------------|------------|--|
| Option | On | Turn on the frequency filter function, which is inserted into frequency measurement input circuit and affects frequency measurements with high frequency components included within measured values. The F.F status icon on the display lights up in green. |
| | Off | Turn off the frequency filter function. The cutoff frequency is 500 Hz. |
| Default value | Off | |

Setting up crest factor



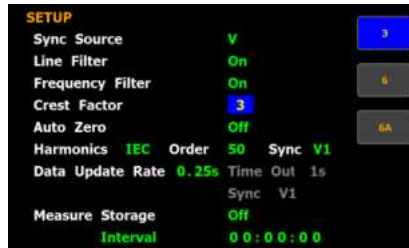

- | | | |
|-------|--|--|
| Steps | <ol style="list-style-type: none"> 1. Press Setup button. 2. Press Enter button. 3. Press down arrow key to move cursor to the Crest Factor field. 4. Use soft keys to select and confirm the desired option. | 

 |
|-------|--|--|



- | | |
|--------|---|
| Option | <ol style="list-style-type: none"> 3 Crest Factor is 3. 6 Crest Factor is 6. 6A Crest Factor is 6A where input range of measurement range will be extended and greater than 6. This is practical for restraining from frequent range changes while measuring, under auto range, a distorted waveform. |
|--------|---|

Default value **3**

Setting up auto-zero function





- | | | |
|-------|---|---|
| Steps | 1. Press Setup button. |  |
| | 2. Press Enter button. |  |
| | 3. Press down arrow key to move cursor to the Auto Zero field. |  |
| | 4. Use soft keys to select and confirm the desired option. |  |



- | | | |
|--------|------------|--|
| Option | On | Auto-zero function is activated once per hour or when range is switched. |
| | Off | Auto-zero function is only activated once when the range is switched. The auto-zero function is turned off when the integrator function is executed. |

Default value **Off**

Setting up method of calculating harmonics

- | | | |
|-------|---|---|
| Steps | 1. Press Setup button. |  |
| | 2. Press Enter button. |  |
| | 3. Press down arrow key to move cursor to the Harmonics field. |  |
| | 4. Use soft keys to select and confirm the desired option. |  |

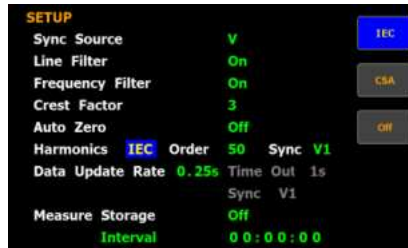

Option	IEC	Calculate the ratio of harmonic quantity of the 2nd through the upper limit 50th harmonic to the 1st harmonic. The HRM.I status icon, for example, on the display lights up in green when IEC is selected for harmonics.
	CSA	Calculate the ratio of harmonic quantity of the 2nd through the upper limit 50th harmonic to the 1st through the 50th harmonic.
	Off	Turn off the harmonic calculation function.

Default value **IEC**

- | | | |
|-------|--|---|
| Steps | 5. Press right arrow key to move cursor to Order field. |  |
|-------|--|---|

- Use soft keys to increase or decrease the order number.



Option	1-50	Set the upper limit of measured harmonic order within the range from 1 to 50.
--------	-------------	---

Default value	50
---------------	-----------

- Press right arrow key to move cursor to **Sync** field.







- Use soft keys to increase or decrease the order number.



Option	V1, V2, V3, I1, I2 and I3
--------	----------------------------------

Default value	V1
---------------	-----------

Setting up data update rate

- | | | |
|-------|---|--|
| Steps | <ol style="list-style-type: none"> 1. Press Setup button. 2. Press Enter button. 3. Press down arrow key to move cursor to the Data Update Rate field. 4. Use soft keys to select and confirm the desired option. Press the “More” soft keys to toggle among pages for further options. | 

 |
|-------|---|--|



- | | | |
|--------|---|--|
| Option | <p>0.1 s / 0.25 s / 0.5 s / 1 s / 2 s / 5 s / 10 s / 20 s</p> <p>Auto</p> | <p>Measured value is updated in accordance with the designated time interval. The Update 5 s status icon, for example, on the display lights up in green when 5 s option is selected.</p> <p>Data is only updated when a set period (Time Out) of the input waveform is detected.</p> |
|--------|---|--|

Default value **0.25 s**

- | | | |
|-------|---|---|
| Steps | <ol style="list-style-type: none"> 5. When Auto for Data Update Rate is selected, press right arrow key to move cursor to Time Out field. |  |
|-------|---|---|

- Use soft keys to select and confirm the desired option.



Option **1 s / 5 s / 10 s / 20 s** Time out period acts like the time limit for detecting a period of the input waveform

Default value **1 s**



Note

Time Out function is only available when Auto is selected for Data Update Rate.

Steps

- When Auto for Data Update Rate is selected, press right and down arrow keys to move cursor to **Sync** field.



- Use soft keys to select and confirm the desired option.



Option **Sync Source** V1, V2, V3, I1, I2, I3 (For GPM-8330-60)
V1, V3, I1, I3 (For GPM-8320-60)



Default value **1 s**



Note

Sync function is only available when Auto is selected for Data Update Rate.

Setting up measure storage

- | | | |
|-------|---|---|
| Steps | <ol style="list-style-type: none"> 1. Press Setup button. 2. Press Enter button. 3. Press down arrow key to move cursor to the Measure Storage field. | 

 |
|-------|---|---|



Note

Measure Storage function is Not available when Auto is selected for Data Update Rate.

4. Use soft keys to select and confirm the desired option.



- | | |
|--------|---|
| Option | <p>On All measured date will be stored to the internal memory by designated time interval for repeating the storage operation. The STORE status icon, for example, on the display lights up in green when Measure Storage function is turn on.</p> <p>Off Turn off the measure storage function.</p> |
|--------|---|

Default value **Off**

- | | | |
|-------|--|---|
| Steps | <ol style="list-style-type: none"> 5. Press down arrow key to move cursor to Interval field. |  |
|-------|--|---|

6. Use soft keys to increase or decrease the interval.



Option The setting range for Interval is from 00:00:00 to 99:59:59.

Default value **00:00:00**







Note

When it is set 00:00:00, the interval for measure storage will be synchronized with the designated Data Update Rate.

Storage stops in the following circumstances:

- When data has been stored to all blocks, Normal measure data can be stored 10000 blocks and Normal with Harmonic data can be stored 1000 blocks.
- When the storage setting is set to Off (while storage is in progress)
- If you press the HOLD key to hold the display while storage is in progress, the measurement operation and the storage interval time counter are held (paused), which causes the storage operation itself to be held. If integration is in progress, this instrument continues measurement and integration in the background.

Setting up average function

- | | | |
|-------|---|---|
| Steps | 1. Press Setup button. |  |
| | 2. Press Average soft key. |  |
| | 3. Press Enter button. |  |
| | 4. Press down arrow key to move cursor to the State field. |  |
| | 5. Use soft keys to select and confirm the desired option. |  |



- | | | |
|--------|------------|--|
| Option | On | Turn Average function On for either Linear or Exponential averages of numeric data. It is particularly practical for large changes in load or power of low input signal frequency. |
| | Off | Turn off Average function. |

Default value **Off**

- | | | |
|-------|--|---|
| Steps | 6. Press down arrow key to move cursor to Type field. |  |
|-------|--|---|

7. Use soft keys to select and confirm the desired option.



Option	Linear	With the designated linear count, it is used to compute linear averages.
	Exponent	With the specified attenuation count, numeric data will be averaged exponentially.

Default value **Linear**

- Steps 8. Press down arrow key to move cursor to **Count** field.







9. Use soft keys to select and confirm the desired option.



Option	8/ 16/ 32/ 64	It includes 8, 16, 32 and 64 for exponentially attenuation count and linearly average count. The AVG-8 status icon, for example, on the display lights up in green when 8 is selected for average.
--------	----------------------	---

Default value **8**

Setting up the voltage and current skipping configuration

- | | | |
|-------|--|---|
| Steps | 1. Press Setup button. |  |
| | 2. Press V / I Range soft key. |  |
| | 3. Press Enter button. |  |
| | 4. Press down arrow key to move cursor to the Mode field. |  |
| | 5. Use soft keys to select and confirm the desired option. |  |



Option	Menu	When user is configuring range setting, the measured data will Not be displayed.
	Quick	The measured data will be displayed simultaneously while measurement range is being switched by user. This is practical for frequent switch of measurement range.

Default option **Menu**

- | | | |
|-------|---|---|
| Steps | 6. Press down arrow key to move cursor to Skipping Config field. |  |
|-------|---|---|

7. Use soft keys to select and confirm the desired option.



Option	On	It is able to skip certain measurement range(s) that are not used by turning on this feature. It can reduce measured data loss which happens while ranges are switched.
	Off	Turn off the function.

Default option **Off**

- Steps 8. Press down arrow key to move cursor to each field of both **V-Range** and **I-Range**.



9. Use soft keys to enable or disable the skipping function for each range.



Option	On	The box of range will be checked when the range is enabled for skipping function.
	Off	The range is disabled for skipping function.

Default option **Off**

Steps

10. Press down arrow key to move cursor to **Peak Over** field for V-Range and I-Range, respectively.



11. Use soft keys to select and confirm the desired option. Press the **More** soft key to toggle among pages for Peak Over of V-Range and I-Range.



Option

When the occurrence of peak over-range happens in Auto range mode, user is able to define a measurement range to switch to. The available options for each mode are listed below.

When it is under CF3 mode for V-Range.

Off/ 15 V / 30 V / 60 V / 150 V / 300 V / 600 V

When it is under CF6/6A mode for V-Range.

Off/ 7.5 V / 15 V / 30 V / 75 V / 150 V / 300 V

When it is under CF3 mode for I-Range.

Off/ 1 A / 2 A / 5 A / 10 A / 20 A / 60 A

When it is under CF6/6A mode for I-Range.

Off/ 0.5 A / 1 A / 2 A / 5 A / 10 A / 30 A

Default option





Off

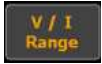

Note

The available options for Peak Over field are limited within the selected options from the V-Range and I-Range sections above.



Setting up the skipping configuration for external

- | | | |
|-------|---|---|
| Steps | 1. Press Setup button. |  |
| | 2. Press V / I Range soft key. |  |
| | 3. Press Enter button. |  |
| | 4. Press down arrow key to move cursor to Skipping Config field. |  |
| | 5. Use soft keys to select and confirm the desired option. |  |



- | | | |
|--------|------------|---|
| Option | On | It is able is skip certain measurement range(s) that are not used by turning on this feature for external input. It can reduce measured data loss which occurs while ranges are switched. |
| | Off | Turn off the function. |

Default option **Off**

- | | | |
|-------|------------------------------------|---|
| Steps | 6. Press ESC button. |  |
| | 7. Press External soft key. |  |
| | 8. Press Enter button. |  |

9. Press down arrow key to move cursor to each field of either **External Sensor 1** or **External Sensor 2**.



10. Use soft keys to enable or disable the skipping function for each range.



Option	On	The box of range will be checked when the range is enabled for skipping function.
	Off	The range is disabled for skipping function.
Default option	Off	

- Steps 11. Press down arrow key to move cursor to **Peak Over** field for External Sensor 1 or External Sensor 2, respectively.



12. Use soft keys to select and confirm desired option. Press **More** soft key to toggle among pages for Peak Over of Ext-1 and Ext-2, respectively.



Option	<p>When the occurrence of peak over-range happens in Auto range mode for external input, user is able to define a measurement range to switch to. The available options for each mode are listed below.</p> <p>When it is under CF3 mode for External Sensor 1.</p> <p>Off/ 2.5 V/ 5 V/ 10 V</p> <p>When it is under CF6/6A mode for External Sensor 1.</p> <p>Off/ 1.25 V/ 2.5 V/ 5 V</p> <p>When it is under CF3 mode for External Sensor 2.</p> <p>Off/ 50 mV/ 100 mV/ 200 mV/ 500 mV/ 1 V/ 2 V</p> <p>When it is under CF6/6A mode for External Sensor 2.</p> <p>Off/ 25 mV/ 50 mV/ 100 mV/ 250 mV/ 0.5 V/ 1 V</p>
--------	--

Default option	Off
----------------	------------



Note

- The available external is based on which external sensor input is enabled beforehand. Be aware that it requests to enable either Ext1 or Ext2 prior to enabling the skipping config for external.
- The available options for Peak Over field are limited within the selected options from the External Sensor 1 and External Sensor 2 sections above.

Setting up the Element for Ratio

Steps

1. Press **Setup** button.

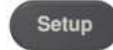

2. Press **Ratio** soft key.



3. Press **Enter** button.



4. Press down arrow key to move cursor to the **Element** field.



5. Use soft keys to select and confirm the desired option. Select **ALL** and then press **OK**.



Option

All

1





2

3

Default option

All

Setting up the VT ratio state

- | | | |
|-------|--|---|
| Steps | 1. Press Setup button. |  |
| | 2. Press Ratio soft key. |  |
| | 3. Press Enter button. |  |
| | 4. Press down arrow key to move cursor to the VT Ratio State field. |  |
| | 5. Use soft keys to select and confirm the desired option. |  |



- | | | |
|--------|------------|--|
| Option | On | Turn on the VT (Voltage Transformer) ratio calculation function and the VT status icon on the display lights up in green. |
| | Off | Turn off the VT ratio calculation function. |

Default option **Off**

- | | | |
|-------|---|---|
| Steps | 6. Press down arrow key to move cursor to Ratio field. |  |
|-------|---|---|

- Use soft keys to increase or decrease coefficient of VT ratio.



Option	The setting range for VT Ratio is from 0000.001 to 9999.999.
Default value	0001.000

Setting up the CT ratio state



- Steps
- Press **Setup** button.
 - Press **Ratio** soft key.
 - Press **Enter** button.
 - Press down arrow key to move cursor to the **CT Ratio State** field.
 - Use soft keys to select and confirm the desired option.



Option	On	Turn on the CT (Current Transformer) ratio calculation function and the CT status icon on the display lights up in green.
	Off	Turn off the CT ratio calculation function.
Default option	Off	

Steps

6. Press down arrow key to move cursor to **Ratio** field.
7. Use soft keys to increase or decrease coefficient of CT ratio.







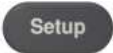

Option	The setting range for CT Ratio is from 0000.001 to 9999.999.
Default value	0001.000

Setting up the power ratio state

Steps

1. Press **Setup** button.
2. Press **Ratio** soft key.
3. Press **Enter** button.
4. Press down arrow key to move cursor to the **Power Ratio State** field.

- Use soft keys to select and confirm the desired option.



Option	On	Turn on the power ratio calculation function and the SF status icon on the display lights up in green.
	Off	Turn off the power ratio calculation function.

Default option **Off**

- Press down arrow key to move cursor to **Ratio** field.





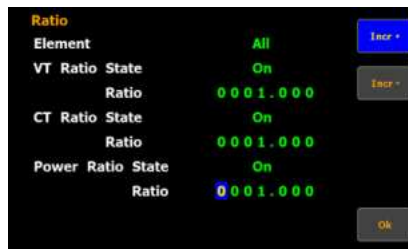

- Use soft keys to increase or decrease coefficient of power ratio.



Option The setting range for power ratio is from 0000.001 to 9999.999.

Default value **0001.000**

Setting up the external sensor input terminal

- | | | |
|-------|---|---|
| Steps | 1. Press Setup button. |  |
| | 2. Press External soft key. |  |
| | 3. Press Enter button. |  |
| | 4. Press down arrow key to move cursor to the External Sensor State field. |  |
| | 5. Use soft keys to select and confirm the desired option. |  |

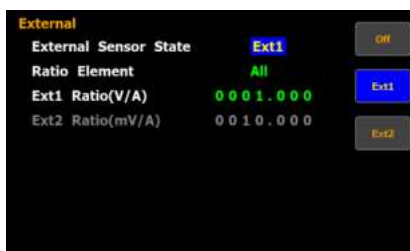

Option	Ext1	Turn on the Ext1 terminal function that receives voltage up to 10 V including shunts and clamps from external output current sensor for measurement and the EXT1 status icon on the display lights up in green.
	Ext2	Almost identical with the Ext1, the Ext2 terminal receives up to 2 V voltage and the EXT2 status icon on the display lights up in green when it is enabled.
	Off	Turn off the external sensor input and return to current input terminal.
Default option	Off	

- Steps
6. Press down arrow key to move cursor to the **Ratio Element** field.
 7. Use soft keys to select and confirm the desired option. Select **ALL** and then press **OK**.

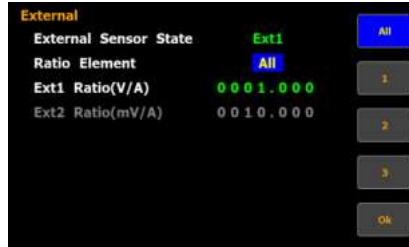

- Option
- All
 - 1
 - 2
 - 3

Default option **All**

- Steps
8. Press down arrow key to move cursor to either **Ext1 Ratio (V/A)** or **Ext2 Ratio (mV/A)** field.
 9. Use soft keys to increase or decrease the conversion ratio of either Ext1 or Ext2.



Option The setting range for both Ext1 and Ext2 is from 0000.001 to 9999.999.

Default value	Ext1	0001.000
	Ext2	0010.000



Note

In order to enable range skipping configuration for external (page 49), it is required to enable external input function first.

Saving and loading the setup parameters

Steps

1. Press **Setup** button.
2. Press **Page 1/2** soft key.
3. Press **Save Load** soft key.
4. Press **Enter** button.
5. Press down arrow key to move cursor to the **Type** field.
6. Use soft keys to select and confirm the desired action.

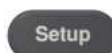

Option	Save	Select Save to store setup parameters into the internal memory.
	Load	Select Load to recall setup parameters back from the internal memory.

Default option **Save**

Steps

7. Press down arrow key to move cursor to **File** field.



8. Use soft keys to select and confirm the desired memory set followed by clicking **Ok** soft key to confirm the Save or Load action.



Option

1 - 4



There are 4 sets of internal memories for saving and loading setup parameters. The **State** field below indicates the status of selected memory set.

Free represents the set is empty without saved parameters, whereas Saved indicates the set has been stored with setup parameters.

Default option

1

Setting up the D/A output configuration

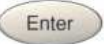

- | | | |
|-------|------------------------------------|---|
| Steps | 1. Press Setup button. |  |
| | 2. Press Page 1/2 soft key. |  |
| | 3. Press D/A soft key. |  |
| | 4. Press Enter button. |  |



Note

Since the DA12 connector is an optional accessory, if it is not available on your unit, the D/A soft key will be disabled in grey color as the figure below shown.



- Press down arrow key to move cursor to the **Preconfigured format** field. 
- Use soft keys to select and confirm the desired option. 



Option	Normal	The D/A output parameters for each channel will be changed to the default setting of Normal mode as follows.	
	Normal Mode	Default value	
	For example	CH1	V1
		CH2	I2
		CH3	P3
		CH4	VHzΣ
	Integrator	The D/A output parameters for each channel will be changed to the default setting of Integrator mode as follows.	
	Integrator Mode	Default value	
	For example	CH1	P1
		CH2	WP2
		CH3	q3
		CH4	VHzΣ

Default option **Normal**

- Steps
7. Press down arrow key to move cursor to **Rated Integrator** field.
 8. Use soft keys to increase or decrease time for rated integrator.

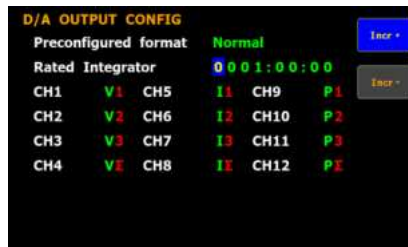

Option In the integrated values of D/A output, GPM-8320-60/8330-60 presumes a rated value is received continuously over the designated time to be 100%, and assigns the value to 5 V. The setting range for time of rated integrator is from 0000:00:00 to 9999:59:59. When the time is set 0000:00:00, D/A output value will be 0 V.

Default value **0001.00:00**

- Steps**
9. Press arrow keys to move cursor to **CH1** through **CH12** field, respectively. 
 10. Use soft keys to select and confirm desired option. Press **More** soft key to toggle among pages for options.



Option It is available to designate the following output items for each output channel.

- V** Voltage
- I** Current
- P** Active power
- VA** Apparent power
- VAR** Reactive power
- PF** Power factor
- DEG** Phase angle
- VHz** Voltage frequency

IHz	Current frequency
VpK	Voltage peak
IpK	Current peak
WP	Total watt hour
WP+	Positive watt hour
WP-	Negative watt hour
q	Total ampere hour
q+	Positive ampere hour
q-	Negative ampere hour
Off	0 V D/A Output

Steps



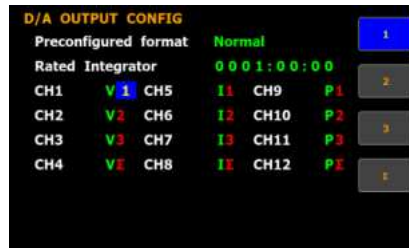



- Also, press arrow keys to move cursor to **channel number** of **CH1** through **CH12** field, respectively.
- Use soft keys to select and confirm desired option.



Option

- 1
- 2
- 3
- Σ

Setting up the hardcopy and log configuration

Steps	1. Press Setup button.	
	2. Press Page 1/2 soft key.	
	3. Press Hardcopy soft key.	
	4. Press Enter button.	
	5. Press down arrow key to move cursor to the Type field.	
	6. Use soft keys to select and confirm the desired option.	
		

Option	Capture	Select Capture to save screenshot file into the inserted USB disk. The file name ranges from SCREEN00.BMP to SCREEN99.BMP.
	Log	Select Log to save data log file into the inserted USB disk. The file name ranges from DATA00.CSV to DATA999.CSV

Default option **Capture**

Steps	7. Press down arrow key to move cursor to Overwrite field.	
-------	---	---

8. Use soft keys to select and confirm the desired action.



Option	On	Turn on overwrite function so that the existed file within the USB disk will be overwritten when saving action is executed.
	Off	By turning off overwrite function, a new saved file will be created and saved into the USB disk when executing saving action.

Default option **Off**









Note

When Overwrite function is On, the latest file name in the inserted USB disk will be overwritten. For instance, when both DATA000.CSV and DATA001.CSV exist in USB disk, the DATA001.CSV will be overwritten accordingly when saving file.

When, on the other hand, Overwrite function is Off, a new one with the latest file name will be created. However, for example, when both SCREEN00.BMP and SCREEN02.BMP exist, a new file named SCREEN01.BMP will be saved since system fills filename vacancy automatically. Also, when saved files are full in USB disk, e.g., from SCREEN00.BMP to SCREEN99.BMP, a warning message will be shown and save action will be Not available.

Setting up the MATH configuration

- | | | |
|-------|---|---|
| Steps | 1. Press Setup button. |  |
| | 2. Press Page 1/2 soft key. |  |
| | 3. Press MATH soft key. |  |
| | 4. Press Enter button. |  |
| | 5. Press down arrow key to move cursor to the Computation field. |  |
| | 6. Use soft keys to select and confirm the desired option. |  |



Option	A+B, A-B, A*B, A/B, A/B², A²/B	Up to 6 computations (A+B, A–B, A×B, A÷B, A÷B ² , A ² ÷B), which are based on the four elementary arithmetic (addition, subtraction, multiplication and division), can be executed by GPM-8320-60/8330-60 with 2 select items out of 5 variables (V, I, P, VA, VAR). The result of computation will be a value without unit.
--------	---	--

Default option **A/B**

- | | | |
|-------|--|---|
| Steps | 7. Press down arrow key to move cursor to Item A field. |  |
|-------|--|---|

8. Use soft keys to select and confirm the desired option.

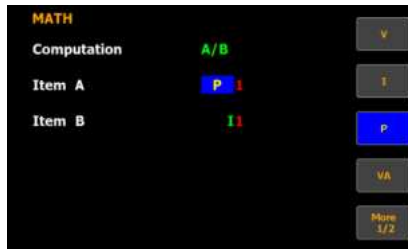

Option	V	Voltage
	I	Current
	P	Active power
	VA	Apparent power
	VAR	Reactive power

Default option V

- Steps 9. Press right arrow key to move cursor to **channel number** of **Item A** field.



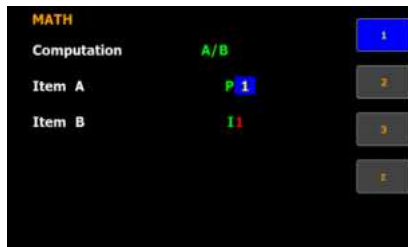

10. Use soft keys to select and confirm the desired option.



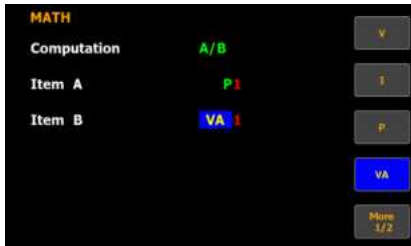

Option	1
	2
	3
	Σ

Default option 1

Steps	<p>11. Press down arrow key to move cursor to Item B field.</p> <p>12. Use soft keys to select and confirm the desired option.</p>	 
		

Option	<p>V Voltage</p> <p>I Current</p> <p>P Active power</p> <p>VA Apparent power</p> <p>VAR Reactive power</p>
--------	---

Default option	<p>I</p>
----------------	-----------------

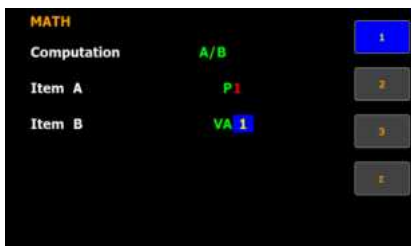
Steps	<p>13. Press right arrow key to move cursor to channel number of Item B field.</p> <p>14. Use soft keys to select and confirm the desired option.</p>	 
		

Option	<p>1</p> <p>2</p> <p>3</p> <p>Σ</p>
--------	---

Default option	<p>1</p>
----------------	-----------------

Setting up System status

System information screen

Steps

1. Press soft key to select **System** function.

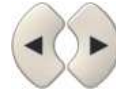

2. Press **Enter** button to Enter **SYSTEM INFORMATION** screen where detailed information including Model, Serial Number, MCU/FPGA Version and MAC Address of the unit is displayed.



System information for GPM-8320-60



System information for GPM-8330-60



3. Press **Enter** button.
4. Press down arrow key to move cursor to **Calibration Password** field.
5. Use soft keys along with left and right arrow keys to input the password followed by pressing **Enter** button twice to enter the Calibration page.

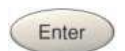

System information for GPM-8320-60



System information for GPM-8330-60



Default option **99999**



Note

Refer to qualified technician and service manual for the calibration procedure.

SYSTEM CONFIG1 screen

Steps

1. Press soft key to select **System** function.



2. Press **Config1** soft key to Enter **SYSTEM CONFIG1** setting screen.

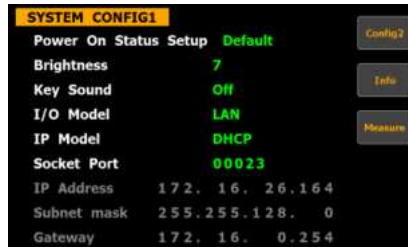

Setting up power on status

Background

Continue the following setting from **SYSTEM CONFIG1** setting screen

Steps

1. Press **Enter** button.
2. Press down arrow key to move cursor to **Power On Status Setup** field.





- Use soft keys to select and confirm the desired option.



Option	Previous	The status of unit on powering on is set to the status before the last shutdown.
	Default	The status of unit on powering on is set to the factory default status.
Default value	Default	

Setting up brightness

Background Continue the following setting from **SYSTEM CONFIG1** setting screen

- Steps**
1. Press **Enter** button. 
 2. Press down arrow key to move cursor to **Brightness** field. 
 3. Use soft keys to increase or decrease the brightness level 

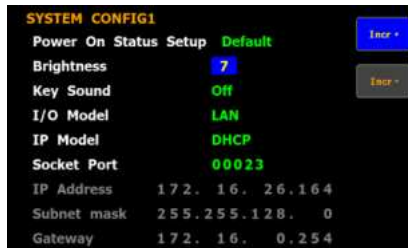



Option **1 - 10** The display is the darkest when set to 1. On the contrary, it turns out the brightest when set to 10.

Default option **7**

Setting up key sound

Background Continue the following setting from **SYSTEM CONFIG1** setting screen

- Steps**
1. Press **Enter** button. 
 2. Press down arrow key to move cursor to **Key Sound** field. 

- Use soft keys to select and confirm the desired option.



Option	On	A short sound is heard from speaker of unit when pressing the keys on the front panel.
	Off	No sound from speaker of unit when pressing the keys on the front panel.
Default option	Off	

Setting up remote interface

Background Continue the following setting from **SYSTEM CONFIG1** setting screen

Steps

- Press **Enter** button.
- Press down arrow key to move cursor to **I/O Model** field.
- Use soft keys to select and confirm the desired option.



Option RS232 If interface is set to RS232, the **Baud Rate** and the **Terminator** fields can be selected. For details about configuring RS 232 interface, please see page 136.



USB For details about configuring USB interface, please see page 135.



GPIB If interface is set to GPIB, the **GPIB Address** can be selected from “1” to “30”. Please see page 138 for details.



LAN If interface is set to LAN, the IP model is can be selected from “Manual” and “DHCP”. For details about configuring LAN interface, please see page 140.



SYSTEM CONFIG2 screen

Steps



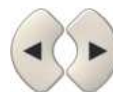

1. Press soft key to select **System** function.

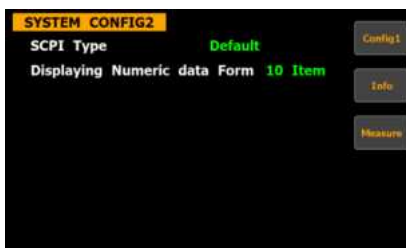

2. Press **Config2** soft key to Enter **SYSTEM CONFIG2** setting screen.





Setting up SCPI identity

Background	Continue the following setting from SYSTEM CONFIG2 setting screen	
Steps	<ol style="list-style-type: none"> 1. Press Enter button. 2. Press down arrow key to move cursor to SCPI Type field. 3. Use soft keys to select and confirm the desired option. 	  
		
Option	<p>Default</p> <p>User</p>	<p>The return message in remote control returns the default manufacturer, model number, serial number, among other info.</p> <p>User-defined manufacturer, model number and so forth will be returned for remote control mode.</p>
Default value	Default	

Setting up Numeric data Form

Background Continue the following setting from **SYSTEM CONFIG2** setting screen

- Steps**
1. Press **Enter** button. 
 2. Press down arrow key to move cursor to **Displaying Numeric data Form** field. 
 3. Use soft keys to select and confirm the desired option.

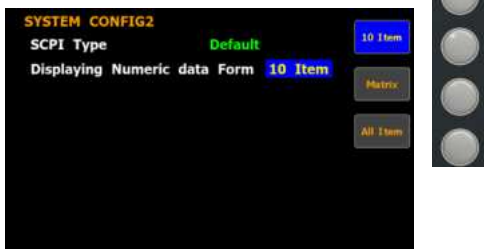

Option **10 Item**

Matrix

All Item

Default value **10 Item**

MEASUREMENT AND OTHER FUNCTIONS

Measurement function	81
Introduction to measurement parameters	81
Measurement display pages overview	82
Setting measurement parameters	88
Changing the numeric display.....	91
Changing the standard and simple display modes ...	93
Other functions	94
Introduction to other functions	94
Integration measurement function.....	97
Setting up Integrator measurement	97
Introduction to integrator parameters	101
Using the integrator function.....	104
Graph measurement function	107
Setting up waveform graph measurement.....	107
Setting up waveform graph parameter and element	115
Setting up Harmonics bar graph measurement and element	118
Setting up Harmonics list graph measurement.....	122

Measurement function

The GPM-8320-60/8330-60 provides a wide range of basic electricity and power measurement functions. It equips with different accurate measurement parameters for accurately measuring the voltage, current, power, DC/AC/AC + DC/V-MEAN, power factor, harmonics, frequency, etc. The input impedance of the device is 2 M Ω , and the maximum input voltage is 1000 Vrms. The internal resistance (Shunt) of the device is 1.65 m Ω , and the maximum input current is 70 Arms. Also, there are 2 external current input terminals (EXT1, EXT2). The device will issue a warning sound when the input voltage and current exceed 1050 Vrms or 72 Arms.

Introduction to measurement parameters

Parameter name	Display icon
Voltage	Vac (AC) Vdc (DC) Vrms (AC+DC) Vmn (V-MEAN)
Current	Iac (AC) Idc (DC) Irms (AC+DC, V-MEAN)
Active Power	P
Apparent Power	VA
Reactive power	VAR
Power Factor	PF
Phase Angle	DEG
Frequency	IHz, VHz
Voltage Peak	V+pk, V-pk

Current Peak	I+pk, I-pk
Active Power Peak	P+pk, P-pk
Total Harmonic Distortion	THDI, THDV
Crest factor	CFV, CFI
Mathematical Computation	MATH, EffI
Maximum Current Ratio (Crest Factor(CFI) / Power Factor)	MCR

Measurement display pages overview

Single channel display mode

1. Press up and down arrow keys to navigate through the display pages. The Σ shows summations of all channels for each measurement parameter.



Page 1



Page 2



Page 3 Page 3



Page 4 Page 4



Note

It is available to set measurement parameters for each page. Refer to page 86 for more details.

Multiple channels display mode

- When it is under “Element 1, 3” or “Element 1, 3 & Σ” numeric displays, press up and down arrow keys to navigate through different pages in which more measurement parameters for each channel are clearly shown. Refer to page 91 for details of Numeric display.





Note

It is available to set measurement parameters for each page. Refer to page 86 for more details.

Element 1, 3 display mode
(For GPM-8320-60)

Page 1 Page 1

	Element1	Element2	Element3
Vrms[V]	9.9984	-----	5.5896
Irms[A]	699.19m	-----	91.434m
P[W]	6.9908	-----	511.07m
VA[VA]	6.9908	-----	511.08m
VAR[var]	8.2462m	-----	+2.6780m
PF[]	1.0000	-----	1.0000
DEG[°]	0.1	-----	+0.3
VHz[Hz]	-----m	-----	55.000

Page 2 Page 2

	Element1	Element2	Element3
Vrms[V]	9.9985	-----	5.5895
V+pk[V]	10.02	-----	7.929
V-pk[V]	9.972	-----	-7.910
CFV[]	1.0026	-----	1.4186
VHz[Hz]	-----m	-----	55.000
THDV[%]	-----	-----	-----
VA[VA]	6.9904	-----	511.05m
VAR[var]	8.2462m	-----	+2.6839m

Page 3 Page 3

	Element1	Element2	Element3
Irms[A]	699.12m	-----	91.831m
I+pk[A]	702.1m	-----	131.0m
I-pk[A]	696.5m	-----	-130.8m
CFI[]	1.0043	-----	1.4267
IHz[Hz]	-----m	-----	55.000
THDI[%]	-----	-----	-----
VA[VA]	6.9902	-----	513.29m
VAR[var]	8.2462m	-----	+2.6280m

Page 4 Page 4

	Element1	Element2	Element3
P[W]	6.9898	-----	510.56m
P+pk[W]	7.0239	-----	1.0318
P-pk[W]	6.9534	-----	-0.0243m
VA[VA]	6.9898	-----	510.57m
VAR[var]	8.4853m	-----	+2.6955m
PF[]	1.0000	-----	1.0000
VHz[Hz]	-----m	-----	55.000
IHz[Hz]	-----m	-----	54.999

Element 1,3 & Σ
display mode

Page 1 Page 1

	Element1	Element2	Element3	Σ
Vrms[V]	9.9984	-----	5.5894	7.7939
Irms[A]	699.08m	-----	91.336m	395.21m
P[W]	6.9897	-----	510.50m	7.5002
VA[VA]	6.9897	-----	510.51m	7.5002
VAR[var]	8.0000m	-----	+2.8804m	10.880m
PF[]	1.0000	-----	1.0000	1.0000
DEG[°]	0.1	-----	+0.3	0.1
VHz[Hz]	-----m	-----	55.000	-----m

Page 2 Page 2

	Element1	Element2	Element3	Σ
Vrms[V]	9.9982	-----	5.5893	7.7938
V+pk[V]	10.02	-----	7.929	-----
V-pk[V]	9.972	-----	-7.907	-----
CFV[]	1.0026	-----	1.4186	-----
VHz[Hz]	-----m	-----	55.000	-----m
THDV[%]	-----	-----	-----	-----
VA[VA]	6.9895	-----	508.98m	7.4985
VAR[var]	8.2462m	-----	+2.7698m	11.016m

Page 3 Page 3

	Element1	Element2	Element3	Σ
Irms[A]	699.09m	-----	91.201m	395.14m
I+pk[A]	701.9m	-----	130.5m	-----m
I-pk[A]	696.5m	-----	-130.8m	-----m
CFI[]	1.0040	-----	1.4345	-----
IHz[Hz]	-----m	-----	54.996	-----m
THDI[%]	-----	-----	-----	-----
VA[VA]	6.9896	-----	509.74m	7.4994
VAR[var]	8.9443m	-----	+3.0388m	11.983m

Page 4 Page 4

	Element1	Element2	Element3	Σ
P[W]	6.9896	-----	508.10m	7.4977
P+pk[W]	7.0255	-----	1.0285	-----m
P-pk[W]	6.9594	-----	-0.0141m	-----m
VA[VA]	6.9896	-----	508.11m	7.4978
VAR[var]	8.2462m	-----	+2.9817m	11.228m
PF[]	1.0000	-----	1.0000	1.0000
VHz[Hz]	-----m	-----	55.000	-----m
IHz[Hz]	-----m	-----	54.998	-----m

Element 1 – 3
display mode
(For GPM-8330-
60)

Page 1 Page 1

	Element1	Element2	Element3
Vrms[V]	0.0000	0.0000	0.0000
Irms[A]	0.0000m	0.0000m	0.0000m
P[W]	0.0000m	0.0000m	0.0000m
P-pk[W]	-1.3775m	-2.7574m	-2.0680m
VAR[var]	0.0000m	0.0000m	0.0000m
PF[]	-----	-----	-----
DEG[°]	-----	-----	-----
VHz[Hz]	-----m	-----m	-----m

Page 2 Page 2

	Element1	Element2	Element3
Vrms[V]	0.0000	0.0000	0.0000
V+pk[V]	0.452	0.226	0.339
V-pk[V]	-0.226	-0.452	-0.339
CFV[]	-----	-----	-----
VHz[Hz]	-----m	-----m	-----m
THDV[%]	-----	-----	-----
VA[VA]	0.0000m	0.0000m	0.0000m
VAR[var]	0.0000m	0.0000m	0.0000m

Page 3 Page 3

	Element1	Element2	Element3
Irms[A]	0.0000m	0.0000m	0.0000m
I+pk[A]	10.17m	10.17m	10.17m
I-pk[A]	-6.101m	-6.104m	-6.104m
CFI[]	-----	-----	-----
IHz[Hz]	-----m	-----m	-----m
THDI[%]	-----	-----	-----
VA[VA]	0.0000m	0.0000m	0.0000m
VAR[var]	0.0000m	0.0000m	0.0000m

Page 4 Page 4

	Element1	Element2	Element3
P[W]	0.0000m	0.0000m	0.0000m
P+pk[W]	2.7549m	2.7574m	2.0677m
P-pk[W]	-1.3775m	-2.7574m	-3.4466m
VA[VA]	0.0000m	0.0000m	0.0000m
VAR[var]	0.0000m	0.0000m	0.0000m
PF[]	-----	-----	-----
VHz[Hz]	-----m	-----m	-----m
IHz[Hz]	-----m	-----m	-----m

Element 1 – 3 & Σ
display mode

Page 1 Page 1

V-R 1000 V AC-DC CF3 SYNC.V HRM.1
I-R 20 A Update 0.25s

Page: 1

	Element1	Element2	Element3	Σ
P+pk [W]	2.7549m	2.7574m	2.0677m	-----m
Irms [A]	0.0000m	0.0000m	0.0000m	0.0000m
P [W]	0.0000m	0.0000m	0.0000m	0.0000m
VA [VA]	0.0000m	0.0000m	0.0000m	0.0000m
VAR [var]	0.0000m	0.0000m	0.0000m	0.0000m
PF []	-----	-----	-----	-----
DEG [°]	-----	-----	-----	-----
VHz [Hz]	-----m	-----m	-----m	-----m

Enlarge Integrator Parameter System Numeric

Page 2 Page 2

V-R 1000 V AC-DC CF3 SYNC.V HRM.1
I-R 20 A Update 0.25s

Page: 2

	Element1	Element2	Element3	Σ
Vrms [V]	0.0000	0.0000	0.0000	0.0000
V+pk [V]	0.452	0.226	0.339	-----
V-pk [V]	-0.452	-0.452	-0.339	-----
CFV []	-----	-----	-----	-----
VHz [Hz]	-----m	-----m	-----m	-----m
THDV [%]	-----	-----	-----	-----
VA [VA]	0.0000m	0.0000m	0.0000m	0.0000m
VAR [var]	0.0000m	0.0000m	0.0000m	0.0000m

Enlarge Integrator Parameter System Numeric

Page 3 Page 3

V-R 1000 V AC-DC CF3 SYNC.V HRM.1
I-R 20 A Update 0.25s

Page: 3

	Element1	Element2	Element3	Σ
Irms [A]	0.0000m	0.0000m	0.0000m	0.0000m
I+pk [A]	10.17m	10.17m	10.17m	-----m
I-pk [A]	-6.101m	-6.104m	-6.104m	-----m
CFI []	-----	-----	-----	-----
IHz [Hz]	-----m	-----m	-----m	-----m
THDI [%]	-----	-----	-----	-----
VA [VA]	0.0000m	0.0000m	0.0000m	0.0000m
VAR [var]	0.0000m	0.0000m	0.0000m	0.0000m

Enlarge Integrator Parameter System Numeric

Page 4 Page 4

V-R 1000 V AC-DC CF3 SYNC.V HRM.1
I-R 20 A Update 0.25s

Page: 4

	Element1	Element2	Element3	Σ
P [W]	0.0000m	0.0000m	0.0000m	0.0000m
P+pk [W]	1.3775m	2.7574m	2.0677m	-----m
P-pk [W]	-1.3775m	-2.7574m	-3.4466m	-----m
VA [VA]	0.0000m	0.0000m	0.0000m	0.0000m
VAR [var]	0.0000m	0.0000m	0.0000m	0.0000m
PF []	-----	-----	-----	-----
VHz [Hz]	-----m	-----m	-----m	-----m
IHz [Hz]	-----m	-----m	-----m	-----m

Enlarge Integrator Parameter System Numeric

Setting measurement parameters

Setting parameter 1. Press the **Parameter** soft key in single channel display



2. The 1st measurement parameter will be highlighted in green.



3. Press up, down, left and right arrow keys to select other desired measurement parameter. Press **Enter** button to set desired parameter.



- Use up and down arrow keys to switch display options followed by pressing **Enter** button to confirm the selected parameter.

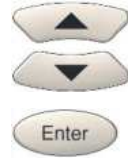

- User is able to apply the previous same process for each measurement parameter. There are up to 2 major and 8 minor measurement parameters to be switched.



- In addition, when changing to “Element 1 - 3” or “Element 1 - 3 & Σ” Numeric mode, it is available to set desired options for up to 8 measurement parameters for one page (up to 4 pages). Refer to page 91 for Numeric display.

Setting parameter in “Element 1- 3” Numeric display



Setting parameter in “Element 1- 3 & Σ” Numeric display



Steps to set channels

- Also, when pressing up, down, left and right arrow keys to select other measurement parameter, it is available to assign channel number of each measurement parameter.



- Press **Enter** button to set desired parameter followed by using up and down arrow keys to switch channel number for the selected measurement parameter.



- User is able to apply the previous same process for assigning channel number of each measurement parameter. There are up to 2 major and 8 minor measurement parameters to be assigned.



Note

- If user changes Numeric display to “Element 1 – 3” or “Element 1 – 3 & Σ”, the channel number selection is Not available since the parameters of all 3 channels are shown on the display already. Refer to page 91 for Numeric display.

Changing the numeric display

Steps

1. Under the single channel display mode, press the **Numeric** soft key.

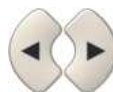

2. The screen is changed to the “Element 1 – 3” display mode in which the 8 measurement parameters of each channel (1 through 3) are shown.

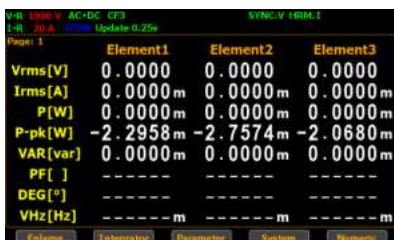

3. Press the **Numeric** soft key again to change to the “Element 1 – 3 & Σ” display mode in which the 8 measurement parameters of each channel (1, 2, 3 and Σ) are shown.



- By pressing the **Numeric** soft key repeatedly to navigate through 3 display modes at any time.



Single channel



Element 1 – 3



Element 1 – 3 & Σ



Changing the standard and simple display modes

Steps

1. In the standard display mode, press soft key to select **Enlarge** function.

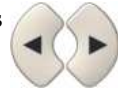

2. The screen is changed to the simple display mode.

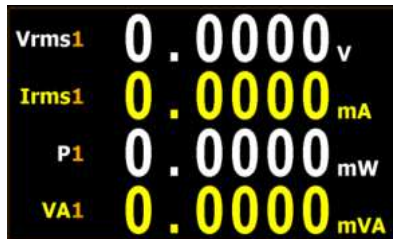

The simple mode covers 4 major measurement parameters deriving from the top 4 parameters of standard mode as shown below.



3. Press **ESC** button to return back to original display mode.







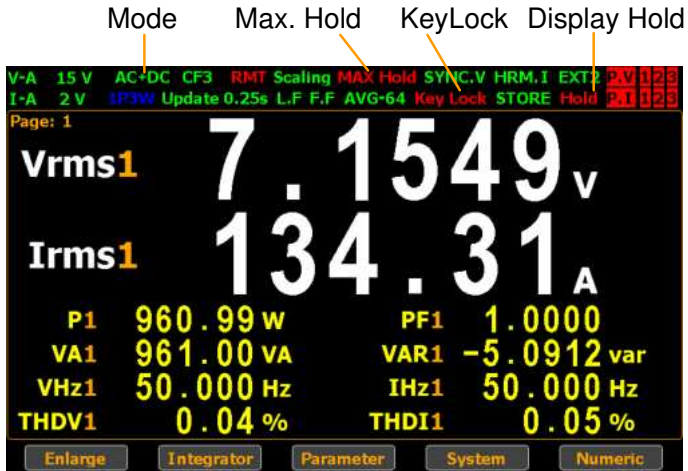

Other functions

Introduction to other functions

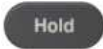
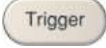

Function name	Button	Description
---------------	--------	-------------

MAX Hold		<p>When the MAX Hold button is pressed, the MAX Hold status icon will light in red in the LCD display to indicate that this function is activated. To deactivate this function, press this button again.</p> <p>If the MAX Hold function is activated, the display value on the display is updated only when the current measured value is greater than the previous measured value. The maximum display value is retained on the display. Only the following parameters are available for MAX Hold function: V, I, P, S, Q, V+pk, V-pk, I+pk, I-pk, P+pk, and P-pk.</p>
Enter		<p>This button is used to select function or confirm selection.</p>
Hold		<p>When the Hold button is pressed, the Hold status icon will light in red in the LCD display to indicate that this function is activated. To deactivate this function, press this button again.</p> <p>When the Hold function is activated, the displayed value on the LCD display is not updated and the range is locked. Measurement is performed in the background.</p>
Trigger		<p>Press the Trigger button when Hold function is activated to update displayed value to the latest status once in accordance with the Data Update Rate period.</p>

ESC		This button is used to exit current screen or return to the main measurement screen.
Local/ Key Lock		Dual function key. When Remote mode is activated, press this button to deactivate Remote mode and switch to Local mode. When Remote mode is not activated, this button is used as lock key of keypad.
Mode		Press the Mode button to select measurement mode. There are 4 measurement modes. <ul style="list-style-type: none">• AC+DC: Displays all the components of measurement signal.• DC: Displays the DC part of the measurement signal.• AC: Displays the AC part of the measurement signal.• V-MEAN: Displays the voltage rectified as a mean value that is calibrated to RMS value. The value is same with those obtained from RMS mode when sine waves are measured, but it is different when DC or distorted waves are measured.

Integration measurement function

Setting up Integrator measurement

Steps

1. Press soft key to select **Integrator** function.



2. The integrator measurement screen is displayed.



Select integrator measurement mode

3. Press soft key to select Set key to enter integrator measurement setting screen.



4. Press **Enter** button to enter **Mode** field. Use up and down arrow keys to toggle between Manual, Standard and Continuous mode. Press **Enter** button again to confirm your selection.



If you select **Manual** mode, the Set Time become disable and displayed in gray.



If you select **Standard** or **Continuous** mode, you need to set integrator measurement time before using integrator function. It can be set from 1 second to 9999 hours, 59 minutes and 59 seconds.



Note

When the Set Time is zero, neither Standard mode nor Continuous mode can be executed.

Select integrator measurement function

5. Press down arrow key to move to **Function** field in the integrator measurement setting screen.



6. Press **Enter** button to enter **Function** field. Use up and down arrow keys to toggle between Ampere Hours and Watt Hours. Press **Enter** button again to confirm your selection.



If you select **Ampere Hours**, the measured value in the bottom half section will be displayed in “q1”.



If you select **Watt Hours**, the measured value in the bottom half section will be displayed in “WP1”.



Select integrator measurement parameter

- Press down arrow key to move to the bottom half section where measured values are displayed.



- Press **Enter** button to enter the 1st minor parameter followed by using up and down arrow keys to switch to preferred measurement parameter. Press **Enter** button again to confirm the selection.



Press left or right arrow keys to move to the 2nd minor parameter followed by using the steps above to select a preferred parameter.



Introduction to integrator parameters

Parameter name	Description
----------------	-------------

Mode

- **Standard**

It allows user to define a period of Set Time for integrator measurement, which ranges from 1 second to 9999 hours, 59 minutes and 59 seconds.

- **Manual**

User is not able to define a Set Time. The integrator measurement will be running constantly till Stop button is pressed by user.

- **Continuous**

Partly identical with the Standard mode, the integrator measurement runs for a cycle of the Set Time and repeats the cycle indefinitely until Stop button is pressed by user.

- Function
- **Watt Hours**
 WP1: Total power
 WP+1:
 Positive total power
 WP-1:
 Negative total
 power
 P(avg)1:
 Average power
 - **Ampere Hours**
 q1: Total mAh
 q+1:
 Positive total mAh
 q-1:
 Negative total mAh
 q(avg)1:
 Average current



Test time It indicates that elapsed time of integrator measurement.

Set time It indicates the time of integrator measurement to be set. It can be set from 1 second to 9999 hours, 59 minutes and 59 seconds.



State • **Running**
 Integrator measurement is in progress.



- **Stop**
Integrator measurement has been stopped manually.



- **Timeout**
The time for running integrator measurement is up.



- **Reset**
The integrator measurement status is cleared.



Measured value parameters

For Watt Hours

Positive total power: **WP+**

Negative total power: **WP-**

Average power: **P(avg)**

Voltage: **Vdc** (DC voltage), **Vac** (AC voltage),

Vrms (AC+DC voltage), **Vmn** (Voltage mean)

Current: **Idc** (DC current), **Iac** (AC current), **Irms** (AC+DC current)



For Ampere Hours

Total mAh: **q**

Positive total mAh: **q+**

Negative total mAh: **q-**

Average Current : **q**(avg)

Voltage: **Vdc** (DC voltage), **Vac** (AC voltage),

Vrms (AC+DC voltage), **Vmn** (Voltage mean)

Current: **Idc** (DC current), **Iac** (AC current), **Irms** (AC+DC current)



Using the integrator function

Manual mode

1. In manual mode, you can directly press the **Start** button in the front panel to start integrator function.

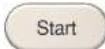

- To stop integration function, press the **Stop** button in the front panel.



- Press the **Reset** button in the front panel to clear integrator.



Standard mode

- Set integrator measurement time before using integrator function.
- Other steps are same as running in manual mode.

When integrator performing, the test time will increase until the set integrator measurement time is reached.



Continuous mode

1. Set integrator measurement time before using integrator function.
2. Other steps are same as running in manual mode.

When integrator performing, the test time will increase until the set integrator measurement time (a cycle) and repeat the cycle indefinitely until the Stop button is pressed by user.



Note

- In the integration process, select the **Measure** key and press **Enter** button to return main measurement screen. Select **Integrator** key and press **Enter** button to switch back to integration measurement screen.
- In the integration process, you can Not change measurement range and enter system to set measurement parameters.
- In the integration process, if the voltage or current measurement value exceeds, the measured value will display in red. However, it will not turn out red color when Auto Range is activated.

Graph measurement function

The GPM-8320-60/8330-60 provides the professional graph measurement function via which user can have a well grip over fluctuations of measured values in waveform and harmonic in bar and list graphs in a friendly user interface. It is available, under the graph mode, to adjust both voltage and current ranges in real time and change the display modes along with relevant parameters with ease.

Setting up waveform graph measurement

Steps

1. Press the **Waveform** key on the front panel of unit.



Select waveform display mode

2. Press the **Set** soft key.



- Press **Enter** button to enter **Display** field. Use up and down arrow keys to toggle between options. Press **Enter** button again to confirm your selection.



Option	V, I, P	Three items including the measured voltage, current and power are displayed in waveforms of different colors (V: yellow, I: red, Power: green) within the waveform chart.
	V, I	Two items including the measured voltage and current are displayed in waveforms of different colors (V: yellow, I: red) within the waveform chart.
	V	Only the measured voltage in the waveform of yellow color is displayed within the chart.
	I	Only the measured current in the waveform of red color is displayed within the chart.
	P	Only the measured power in the waveform of green color is displayed within the chart.
Default option	V, I, P	

Select waveform display time division

4. Press down arrow key to move to **Time Div** field in the waveform setting section.



5. Press **Enter** button to enter **Time Div** field. Use up and down arrow keys to toggle between options. Press **Enter** button again to confirm your selection.



Option

25 μ s, 50 μ s,
100 μ s, 250 μ s,
500 μ s, 1 ms,
2.5 ms, 5 ms,
10 ms, 25 ms,
50 ms, 100 ms,
250 ms, 500
ms, 1 s

The diversified time units allow user to customize a preferred waveform graph display. In theory, shorter the measured period, smaller the time unit is fitting. In contrast, longer the measured period, greater the time unit is suitable. Select a proper option per varied measurements.

Default option

5 ms



Note

The available options for Time Div vary per set Update Time. Refer to page 113 for correlations.

Select waveform display sync source

6. Press right arrow key to move to **Sync** field in the waveform setting section.



7. Press **Enter** button to enter **Sync** field. Use up and down arrow keys to toggle between options. Press **Enter** button again to confirm your selection.



Option	V	Select the voltage of signals as synchronization source.
	I	Select the current of signals as synchronization source.
	Off	Select the entire interval of data updating period as synchronization source.

Default option **V**

Select waveform display zoom magnification

8. Press right arrow key to move to **Zoom (V)** field in the waveform setting section.



9. Press **Enter** button to enter **Zoom (V)** field. Use up and down arrow keys to toggle between options. Press **Enter** button again to confirm your selection.



Option

1, 2, 3

The varied zoom magnifications allow user to customize a preferred waveform graph display. In theory, narrower the measured value, greater the zoom magnification is suitable. In contrast, wider the measured value, smaller the zoom magnification is fitting. The 1 stands for the standard magnification and the 3 represents the highest zoom magnification.

Default option

1

Zoom 1:

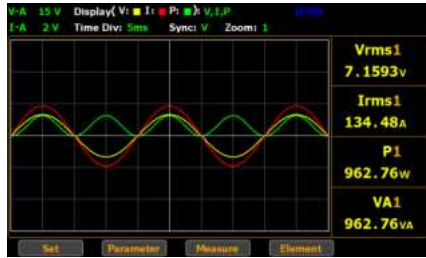

Zoom 2:

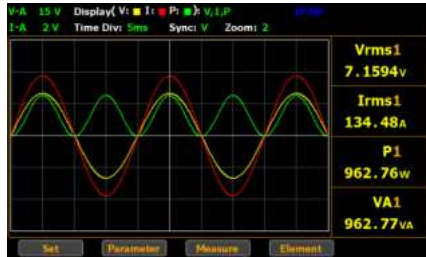

Zoom 3:

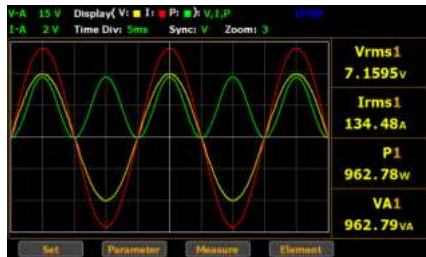

Frequency over limit

When frequency of either voltage or current is beyond the limit, which varies per set Time Div, the warning message in the upper-right corner will be shown to alarm user as the figures below.

F_V_O:
Frequency Voltage Over



F_I_O:
Frequency
Current Over



F_V_I_O:
Frequency
Voltage &
Current Over



Correlation of
 Limit Frequency,
 Time Div and
 Update Time

Time Division	Update Time							
	0.1	0.25	0.5	1	2	5	10	20
1s								•
500ms							•	•
250ms							•	•
100ms						•	•	•
50ms					•	•	•	•
25ms			•	•	•	•	•	•
10ms		•	•	•	•	•	•	•
5ms	•	•	•	•	•	•	•	•
2.5ms	•	•	•	•	•	•	•	•
1ms	•	•	•	•	•	•	•	•
500us	•	•	•	•	•	•	•	•
250us	•	•	•	•	•	•	•	•
100us	•	•	•	•	•	•	•	•
50us	•	•	•	•	•	•	•	•
25us	•	•	•	•	•	•	•	•
Limit Frequency	10kHz	5kHz	2.5kHz	1kHz	500Hz	250Hz	100Hz	50Hz

Take few examples below that derive from the table above for further descriptions.

- When Update Time is set 20 s, the range of Time Div is from 5 ms to 1 s and the available Frequency is up to 50 Hz.
- When Update Time is set 0.1 s, the range of Time Div is from 25 μs to 5 ms and the available Frequency is up to 10 kHz.



Note

- The maximum frequency for Graph mode is up to 10 kHz.
- When the measured frequency of either voltage (VHz) or current (IHz) surpasses the available frequency, which is based on the set Time Div, the warning message will be shown accordingly.

Setting up waveform graph parameter and element

Steps

1. Press the **Waveform** key on the front panel of unit to enter the waveform page.

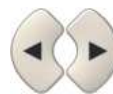

2. Press the **Parameter** soft key.

Parameter



3. Press **Enter** button to enter the 1st parameter. Use up and down arrow keys to toggle between options. Press **Enter** button again to confirm your selection.



4. Press down arrow key to move cursor to the 2nd parameter and repeat the above steps to set up. Also, repeat the same steps for the 3rd and 4th parameters.

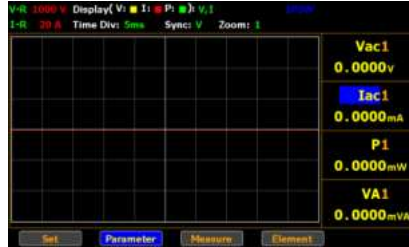

Option	Voltage	Vac (AC) Vdc (DC) Vrms (AC+DC) Vmn (V-MEAN)
	Current	Iac (AC) Idc (DC) Irms (AC+DC, V-MEAN)
	Active Power	P
	Apparent Power	VA
	Reactive power	VAR
	Power Factor	PF
	Phase Angle	DEG
	Frequency	IHz, VHz
	Voltage Peak	V+pk, V-pk
	Current Peak	I+pk, I-pk
	Active Power Peak	P+pk, P-pk

Total Harmonic Distortion	THDI, THDV
Crest factor	CFV, CFI
Mathematical Computation	MATH, EFFi
Maximum Current Ratio	MCR

Default option Default options are based on the Parameter settings from the standard display mode.

5. Press the **ESC** key twice on the front panel of unit.



6. Press the **Element** soft key to change channel number of each parameter

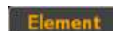

Element 1



Element 2



Element 3



Setting up Harmonics bar graph measurement and element

Steps

1. Press the **Harmonic** key on the front panel of unit to enter the harmonics bar graph display screen where measured values of each harmonic order are shown in the histogram-like bar display.

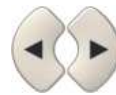

2. Press the **Set** soft key.

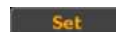

Select harmonics display mode 3. Press **Enter** button to enter **Display Mode** field. Use up and down arrow keys to toggle between options. Press **Enter** button again to confirm your selection.



- Option **V** The THDV measured factor will be displayed in the right-side section in yellow and also shown in the left-side bar graph.
- I** The THDI measured factor will be displayed in the right-side section in yellow and also shown in the left-side bar graph.

Default option **V**

Select harmonics display order number 4. Press down arrow key to move to **Order No.** field in the harmonics setting section.



- Press **Enter** button to enter **Order No.** field. Use up and down arrow keys to toggle between options. Press Enter button again to confirm your selection.



Option **1 - 50** Select a measured harmonic order with related values to be displayed in both the right-side section in green and the left-side bar graph. Note that the upper limit of order number is relevant to the Harmonics setting (page 38).

Default option **1**

- Press right arrow key to move to **HRM** field in the harmonics setting section.



- Press **Enter** button to enter **HRM** field. Use up and down arrow keys to toggle between options. Press Enter button again to confirm your selection.



Option	IEC
	CSA
	OFF
Default option	IEC

- Press the **ESC** key twice on the front panel of unit.



- Press the **Element** soft key to change channel number of each parameter



Element 1



Element 2



Element 3



Setting up Harmonics list graph measurement

Steps

1. Press the **Harmonic** key on the front panel of unit to enter the harmonics bar graph display.



2. Press the **List** soft key to enter the harmonics list display.



Order	V (V)	I (mA)	P (mW)	V Hdf(%)	I Hdf(%)	P Hdf(%)	V(°)	I(°)
Total	-----	-----	-----	-----	-----	-----	-----	-----
1	-----	-----	-----	-----	-----	-----	-----	-----
2	-----	-----	-----	-----	-----	-----	-----	-----
3	-----	-----	-----	-----	-----	-----	-----	-----
4	-----	-----	-----	-----	-----	-----	-----	-----
5	-----	-----	-----	-----	-----	-----	-----	-----
6	-----	-----	-----	-----	-----	-----	-----	-----
7	-----	-----	-----	-----	-----	-----	-----	-----

Turn pages of harmonics list

3. Press up and down arrow keys individually to flip over pages of the harmonics list in which relevant values of each order of harmonics are well displayed. See the section below for descriptions of each item within the list.



Order	V (V)	I (mA)	P (mW)	V Hdf(%)	I Hdf(%)	P Hdf(%)	V(°)	I(°)
Total	-----	-----	-----	-----	-----	-----	-----	-----
50	-----	-----	-----	-----	-----	-----	-----	-----

Order	V (V)	I (mA)	P (mW)	V Hdf(%)	I Hdf(%)	P Hdf(%)	V(°)	I(°)
Total	-----	-----	-----	-----	-----	-----	-----	-----
8	-----	-----	-----	-----	-----	-----	-----	-----
9	-----	-----	-----	-----	-----	-----	-----	-----
10	-----	-----	-----	-----	-----	-----	-----	-----
11	-----	-----	-----	-----	-----	-----	-----	-----
12	-----	-----	-----	-----	-----	-----	-----	-----
13	-----	-----	-----	-----	-----	-----	-----	-----
14	-----	-----	-----	-----	-----	-----	-----	-----

Items of the list

Order

The harmonic order number

V

RMS voltage value of the harmonic order

I	RMS current value of the harmonic order
P	Active power value of the harmonic order
V Hdf(%)	Voltage harmonic distortion factor of the harmonic order
I Hdf(%)	Current harmonic distortion factor of the harmonic order
P Hdf(%)	Power harmonic distortion factor of the harmonic order
V (°)	The phase difference between the fundamental voltage and the voltage of the harmonic order
I (°)	The phase difference between the fundamental current and the current of the harmonic order

DIGITAL I/O / DA12

Digital I/O / DA12 Overview.....	126
External Remote Control.....	128
DA12 Output Function	129

Digital I/O / DA12 Overview

Background

The digital I/O /DA12 port contains up to two modes: External Remote Control and DA12 Output Function.

Use the external I/O connector on the rear panel to control the instrument remotely and produce D/A output.

By providing separate VCC power for the terminal, the outputs can also be used as a power source for TTL and CMOS circuits.

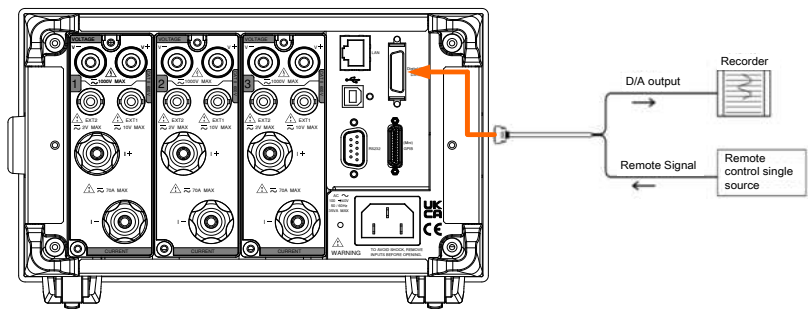

Pin Assignment Connector type: SCSI 26 pin female

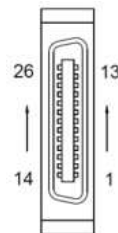

Pin No.	Signal Name	Pin No.	Signal Name
1	EXT COM	14	EXT SINGLE In
2	EXT HOLD In	15	EXT STOP In
3	EXT START In	16	INTEG BUSY Out
4	EXT RESET In	17	No connection
5	No connection	18	DA 12Ch Out
6	DA 11Ch Out	19	DA 10Ch Out
7	DA 9Ch Out	20	DA 8Ch Out

8	DA 7Ch Out	21	DA 6Ch Out
9	DA 5Ch Out	22	DA 4Ch Out
10	DA 3Ch Out	23	DA 2Ch Out
11	DA 1Ch Out	24	DA COM
12	DA COM	25	No connection
13	DA COM	26	No connection



Note

The Digital GND and D/A GND signals are connected internally.



CAUTION

1. Do not apply voltage outside the range of 0 V to 5 V to the remote control input pins. Also, do not short the output pins or apply external voltage to them. If you do, the instrument may malfunction.
2. Do not short the D/A output terminal or apply external voltage to it. If you do, the instrument may malfunction.
3. When connecting the D/A output to another device, do not connect the wrong signal pin. Doing so may damage this instrument or the connected instrument.
4. Pin17: VCC output, 5 V. It serves as the unregulated max power source for the external device/logic. The maximum current is 100 mA.
5. Pin5: Flyback Diode. It connects to VCC or External power source.

External Remote Control

Overview Through external control, you can hold values, perform single measurements, and start, stop, and reset integration.

Remote Control IO Circuit

Input diagram

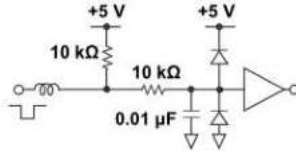

Output diagram

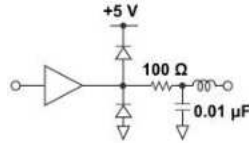

Pulse width timing Start, Stop, Reset, hold, Trigger

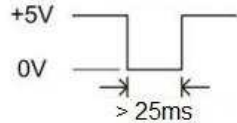

Integ Busy Out

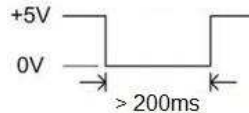

Note

The Integ Busy output signal is set to low level during integration. Use this signal when you are observing integration.

DA12 Output Function

Overview You can output voltage, current, active power, apparent power, reactive power, power factor, phase angle, frequency, voltage peak, current peak, and integrated values using a ± 5 V FS DC voltage.

The output range mode and maximum/minimum value of manual range mode can only be used when using a remote control interface. Likewise this parameter can only be configured via remote control. Please see the commands on page 155 for full usage details.

Output Format You can select a preconfigured output format or configure your own original format.

Preconfigured Format

The image shows two screenshots of the 'D/A OUTPUT CONFIG' menu. The top screenshot shows the 'Normal' preconfigured format. The 'Preconfigured format' is 'Normal', and the 'Rated Integrator' is '0 0 0 1 : 0 0 : 0 0'. The channels are listed as follows: CH1 (V1), CH2 (V2), CH3 (V3), CH4 (VΣ), CH5 (I1), CH6 (I2), CH7 (I3), CH8 (IΣ), CH9 (P1), CH10 (P2), CH11 (P3), and CH12 (PΣ). A 'Measure' button is visible in the top right. The bottom screenshot shows the 'Integrator' preconfigured format. The 'Preconfigured format' is 'Integrator', and the 'Rated Integrator' is '0 0 0 1 : 0 0 : 0 0'. The channels are listed as follows: CH1 (P1), CH2 (P2), CH3 (P3), CH4 (PΣ), CH5 (WP1), CH6 (WP2), CH7 (WP3), CH8 (WPΣ), CH9 (q1), CH10 (q2), CH11 (q3), and CH12 (qΣ). 'Normal' and 'Integrator' buttons are visible in the top right.

Rated Integration Time In the D/A output of integrated values, 5.0 V FS represents the integrated value when the rated range value is applied for the rated integration time. The default setting is 1.00.00 (1 h, 0 min, 0 s).

If you set the rated integration time to 0.00.00, the D/A output value will be 0 V.

Output Range Mode The DA12 have two output range mode: Fixed range mode or Manual range mode. The default setting is Fixed.

Fixed (Fixed range mode) When a measurement function's rated value is received, +5 V is output.

Manual (Manual range mode) You can set which measurement function values result in a D/A output of -5 V, and which result in a D/A output of +5 V. By doing so, you can enlarge or reduce (zoom) the D/A output of each channel.

For example, if you are measuring a current that fluctuates between 0.4 A and 0.6 A with a measurement range of 1 A, when the D/A output range mode is Fixed, the D/A output voltage will fluctuate between 2.0 V and 3.0 V. When you want to observe the fluctuations more closely, you can use the D/A zoom feature. If you set the D/A output range mode to Manual and set the minimum value to 0.4 and the maximum value to 0.6, the instrument will produce -5 V when the measured current value is 0.4 A and +5 V when the measured current value is 0.6 A.

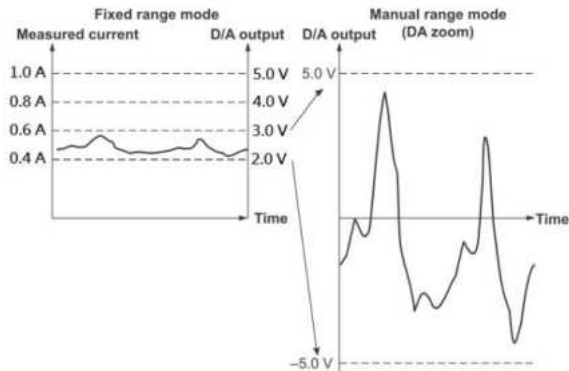

Compare
(Comparator
Mode)

By comparing with the comparator limits, this instrument outputs +5 V, 0 V, or -5 V.

- Below the lower limit: -5 V output
- Greater than or equal to the lower limit and less than the upper limit: 0 V output
- Greater than or equal to the upper limit: +5 V output

Maximum and
Minimum Values
in Manual Range
Mode and
Comparator Mode

The value maximum and minimum is between -9.999E+12 and 9.999E+12.

The default value is 100.0 and -100.0.

Relationship
between Output
Items and D/A
Output Voltage

Frequency

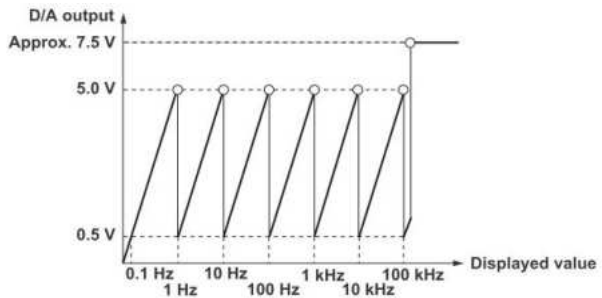

Integrator

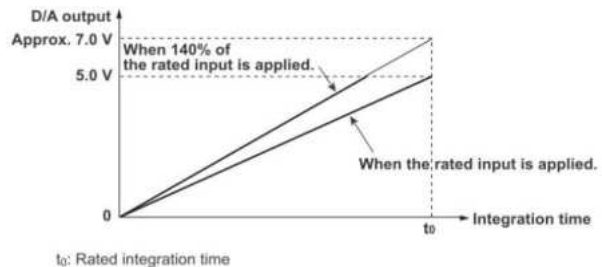

Other

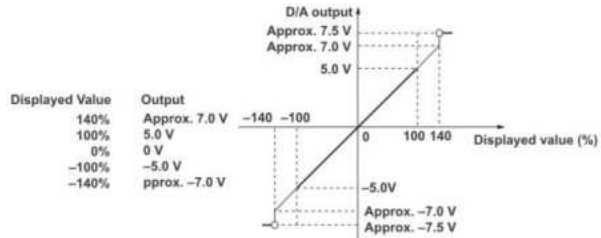

Examples of D/A Output

Voltage:

When the voltage range is set to 150 V and measurement value is 100 V, the output is $100\text{ V}/150\text{ V} \times 5\text{ V} = 3.3\text{ V}$.

Frequency:

When the voltage frequency measurement value is 60 Hz, the D/A output is $60\text{ Hz}/100\text{ Hz} \times 5\text{ V} = 3\text{ V}$.

Power:

When the voltage range is set to 150 V and the current range is set to 2 A, the rated power range is $150\text{ V} \times 2\text{ A} = 300\text{ W}$.

When the measured power value is 150 W, the output is $150\text{ W}/300\text{ W} \times 5\text{ V} = 2.5\text{ V}$.

Integrated Power:

When the voltage range is set to 150 V and the current range is set to 1 A, the rated power range is $150\text{ V} \times 1\text{ A} = 150\text{ W}$. In manual integration mode, when the rated integration time is set to 1 hour, the rated electrical energy value is $150\text{ W} \times 1\text{ h} = 150\text{ Wh}$.

If you perform integration for 1 hour and the measured electrical energy is 150 W, the D/A output one hour after integration start is +5 V.



Note

1. The range between +5 V to +7 V and -5 V to -7 V is not output for λ and Φ . When an error occurs, the output is approximately ± 7.5 V.
2. For Vpk and Ipk, ± 5 V represents the application of 3 times the rated range value (6 times the rated range value when the crest factor is 6 or 6A).
3. Refer to the table below for GPM-8320-60/8330-60 DA parameters calculation.

Item	Calculation	Note
V	$(X / V_range) * 5 V$	
I	$(X / I_range) * 5 V$	
P	$(X / V_range * I_range) * 5 V$	
VA	$(X / V_range * I_range) * 5 V$	
VAR	$(X / V_range * I_range) * 5 V$	
PF	$(X / 1.0) * 5 V$	
DEG	$(X / 180) * -1 * 5 V$	
VHz	$(X / Base_Hz) * 5 V$	For example: Hz = 0.5 Hz, Base_Hz = 1 Hz Hz = 6 Hz, Base_Hz = 10 Hz Hz = 50 Hz, Base_Hz = 100 Hz Therefore, (< 0.1 Hz = 0 V, > 110 kHz = 7.5 V)
IHz	$(X / Base_Hz) * 5 V$	
Vpk	$(X / (V_range * CF)) * 5 V$	
Ipk	$(X / (I_range * CF)) * 5 V$	
WP	$(X / V_range * I_range) * 5 V * (3600 / DA_Time)$	DA_Time Refer to Setup → D/A → Rated Integrator for details.
WP+	$(X / V_range * I_range) * 5 V * (3600 / DA_Time)$	
WP-	$(X / V_range * I_range) * 5 V * (3600 / DA_Time)$	
q	$(X / I_range) * 5 V * (3600 / DA_Time)$	
q+	$(X / I_range) * 5 V * (3600 / DA_Time)$	
q-	$(X / I_range) * 5 V * (3600 / DA_Time)$	
OFF	0 V	

*Variable Definition: X = measured value

REMOTE CONTROL

This chapter describes basic configuration of IEEE488.2 based remote control. For a command list, refer to the Command Overview chapter on page 143.

Configure Remote Control Interface	135
Configure USB Interface	135
Configure RS232 Interface	136
Configure GPIB Interface	138
Configure LAN Interface	140
Configure EOL Character	142
Return to Local Control	142

Configure Remote Control Interface

Configure USB Interface

USB CDC Class Due to the USB port configured to CDC (Communications Device Class) by default, the GPM-8320-60/8330-60 will appear as a virtual COM port to a connected PC. Before, hence, using remote control via CDC USB class, install the appropriate CDC USB driver included on the User Manual CD.

Background Continue the following setting from **SYSTEM CONFIG** setting screen

Steps

1. Press **Enter** button.



2. Press down arrow key to move cursor to **I/O Model** field.







3. Use soft keys to select and confirm the **USB** option.



USB Configuration

PC connector	Type A, host
GPM-8320-60/8330-60	Rear panel Type B, slave connector
Speed	1.1/2.0 (full speed/high speed)
USB Class	CDC (Communications device class)
Hardware flow control	Off
Data Bits	8
Stop bit	1

Configure RS232 Interface

Background	Continue the following setting from SYSTEM CONFIG setting screen	
Steps	<ol style="list-style-type: none"> 1. Press Enter button. 2. Press down arrow key to move cursor to I/O Model field. 3. Use soft keys to select and confirm the RS232 option. 4. Press down arrow key to move cursor to Baud Rate field. 5. Use soft keys to select and confirm the Baud Rate option. 	    
Option	9600, 19200, 38400, 57600, 115200	
Default value	9600	

6. Press down arrow key to move cursor to **Terminator** field.
7. Use soft keys to select and confirm the **Terminator** option.



Option	CR, LF, CR+LF	Terminator indicates the end of line for return message.
--------	----------------------	--

Default value	CR+LF
---------------	--------------

RS232 Configuration	Selectable Baud rate	9600, 19200, 38400, 57600, 115200
---------------------	----------------------	-----------------------------------

	Parity	None
--	--------	------

	Hardware flow control	Off
--	-----------------------	-----

	Data Bits	8
--	-----------	---

	Stop bit	1
--	----------	---



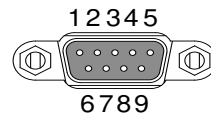

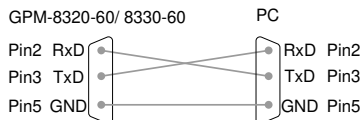

RS232 Pin Assignments	Pin 2: RxD Pin 3: TxD Pin 5: GND Pin 1, 4, 6 ~ 9: No Connection
-----------------------	--



PC Connection	Use a Null Modem connection as shown in the diagram below.
---------------	--

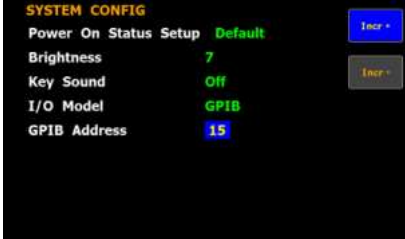

Configure GPIB Interface

Background	Continue the following setting from SYSTEM CONFIG setting screen	
Steps	<ol style="list-style-type: none"> 1. Press Enter button. 2. Press down arrow key to move cursor to I/O Model field. 3. Use soft keys to select and confirm the GPIB option. 	  
		
	<ol style="list-style-type: none"> 4. Press down arrow key to move cursor to GPIB Address field. 5. Use soft keys to increase or decrease to a target GPIB Address. 	 
		
Option	The range of GPIB Address is from 1 to 30 .	
Default option	15	

GPIB Pin Assignments	Pin Signal		Pin Signal	
	Pin	Signal	Pin	Signal
	1	Data I/O 1	13	Data I/O 5
	2	Data I/O 2	14	Data I/O 6
	3	Data I/O 3	15	Data I/O 7
	4	Data I/O 4	16	Data I/O 8
	5	EOI	17	REN
	6	DAV	18	Ground (DAV)
	7	NRFD	19	Ground (NRFD)
	8	NDAC	20	Ground (NDAC)
	9	IFC	21	Ground (IFC)
	10	SRQ	22	Ground (SRQ)
	11	ATN	23	Ground (ATN)
	12	SHIELD Ground	24	Single GND

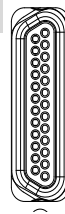

Configure LAN Interface

Background Continue the following setting from **SYSTEM CONFIG** setting screen

Steps 1. Press **Enter** button. 

2. Press down arrow key to move cursor to **I/O Model** field. 

3. Use soft keys to select and confirm the **LAN** option. 



4. Press down arrow key to move cursor to **IP Model** field. 

5. Use soft keys to select and confirm the desired option. 



Option **Manual** Set up IP Address, Subnet mask and Gateway manually.

DHCP DHCP server automatically assigns IP Address, Subnet mask and Gateway.

Default option **DHCP**

Steps

6. Press down arrow key to move cursor to **Socket Port** field.
7. Use soft keys to increase or decrease the parameter of Socket Port.



Option The range of Socket Port is from **00000** to **65535**.

Default option **00023**

Steps

8. When selecting Manual for IP Model, press down arrow key to move cursor to **IP Address**, **Subnet Mask** and **Gateway** fields, individually.
9. Use soft keys to increase or decrease the parameters of **IP Address**, **Subnet Mask** and **Gateway** fields, individually.



Default option IP Address: **192.168.0.100**
 Subnet Mask: **255.255.255.0**
 Gateway: **192.168.0.1**

Configure EOL Character

Description	<p>The system config menu can set the EOL(end-of-line) character for return message.</p> <p>(The USB, GPIB and LAN's EOL character is fixed with CR+LF)</p> <p>The EOL characters that can be received from the PC include CR+LF, LF+CR, CR or LF. The most common EOL character is CR+LF.</p>
-------------	---

Return to Local Control

Background	<p>When the unit is in remote control mode, the RMT icon above the main display can be seen. When this icon is not displayed, it indicates that the unit is in local control mode.</p>
Procedure	<ol style="list-style-type: none">1. Press the Local key when in remote mode.2. The unit will go back into local mode and the RMT icon will turn off.

COMMAND OVERVIEW

The Command overview chapter lists all programming commands in functional order as well as alphabetical order. The command syntax section shows you the basic syntax rules you have to apply when using commands.

Command Syntax

Compatible Standard	IEEE488.2	Partial compatibility
	SCPI, 1994	Partial compatibility
Command Structure	SCPI (Standard Commands for Programmable Instruments) commands follow a tree-like structure, organized into nodes. Each level of the command tree is a node. Each keyword in a SCPI command represents each node in the command tree. Each keyword (node) of a SCPI command is separated by a colon (:).	

For example, the diagram below shows an SCPI sub-structure and a command example.

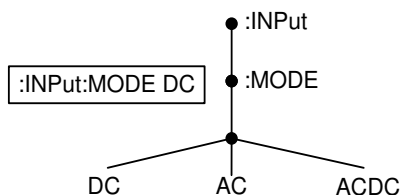

Command Types There are a number of different instrument commands and queries. A command sends instructions or data to the unit and a query receives data or status information from the unit.

Command types

Simple A single command with/without a parameter

Example :INPut:MODE DC

Query A query is a simple or compound command followed by a question mark (?). A parameter (data) is returned.

Example :INPut:CFACtor?

Command Forms Commands and queries have two different forms, long and short. The command syntax is written with the short form of the command in capitals and the remainder (long form) in lower case.

The commands can be written either in capitals or lower-case, just so long as the short or long forms are complete. An incomplete command will not be recognized.

Below are examples of correctly written commands.

Long form :INPut:SYNChronize VOLTage
:COMMunicate:HEADer ON

Short form :INP:SYNC VOLT
:COMM:HEAD ON

Square Brackets Commands that contain square brackets indicate that the contents are optional. The function of the command is the same with or without the square bracketed items, as shown below. For example, for the query:

`[:INPut]:FILTer?`

Both `:INPut:FILTer?` and `:FILTer?` are valid forms.

Command Format

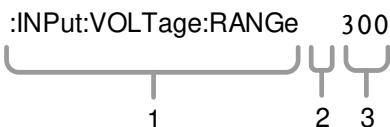

1. Command header
2. Space
3. Parameter 1

Common Input Parameters	Type	Description	Example
	<Boolean>	boolean logic	0, 1
	<NR1>	integers	0, 1, 2, 3
	<NR2>	decimal numbers	0.1, 3.14, 8.5
	<NR3>	floating point with exponent	4.5e-1, 8.25e+1
	<NRf>	any of NR1, 2, 3	1, 1.5, 4.5e-1
	[MIN] (Optional parameter)	For commands, this will set the setting to the lowest value. This parameter can be used in place of any numerical parameter where indicated. For queries, it will return the lowest possible value allowed for the particular setting.	

[MAX] (Optional parameter)	For commands, this will set the setting to the highest value. This parameter can be used in place of any numerical parameter where indicated. For queries, it will return the highest possible value allowed for the particular setting.
----------------------------------	---

Message Terminator (EOL)	Remote Command	Marks the end of a command line. The following messages are in accordance with IEEE488.2 standard. CR+LF The most common EOL character is CR+LF
--------------------------	----------------	---

Message Separator	EOL or ; (semicolon)	Command Separator
-------------------	-------------------------	-------------------

Command List

SCPI Commands	*CLS.....	151
	*ESE.....	151
	*ESR	152
	*IDN	152
	*OPC	152
	*OPT.....	153
	*RST	153
	*SRE	153
	*STB	154
	*TRG.....	154
AOUTput Commands	:AOUTput	155
	:AOUTput[:NORMal]:CHANnel<x>	155
	:AOUTput[:NORMal]:IRTime	156
	:AOUTput[:NORMal]:MODE<x>	156
	:AOUTput[:NORMal]:PRESet.....	157
	:AOUTput[:NORMal]:RATE<x>.....	157
	:AOUTput:DIGital:MODE	158
	:AOUTput:DIGital:OUTPut.....	158
	:AOUTput:DIGital:SETup.....	159
COMMunicate Commands	:COMMunicate.....	160
	:COMMunicate:HEADer	160
	:COMMunicate:LOCKout	161
	:COMMunicate:REMote	161
	:COMMunicate:STATus	162
	:COMMunicate:VERBose.....	162
DISPlay Commands	:DISPlay	164
	:DISPlay:NORMal.....	164
	:DISPlay[:NORMal]:ITEM<x>	164
	:DISPlay:INTegrate:ITEM<x>	166
	:DISPlay:PAGE	167
	:DISPlay:NUMeric[:NORMal]:FORMat	167
	:DISPlay:NUMeric[:NORMal]:PAGE	168

HARMonics	:HARMonics	169
Command	:HARMonics:DISPlay	169
	:HARMonics:DISPlay[:STATe].....	169
	:HARMonics:DISPlay:ORDer	170
	:HARMonics:PLLSource	170
	:HARMonics:ORDer.....	171
	:HARMonics:THD	171
HOLD Command	:HOLD	172
INPut Commands	:INPut	173
	[:INPut]:CFACtor	174
	[:INPut]:WIRing	174
	[:INPut]:MODE	175
	[:INPut]:VOLTage	175
	[:INPut]:VOLTage:RANGe.....	175
	[:INPut]:VOLTage:AUTO	176
	[:INPut]:VOLTage:CONFig	176
	[:INPut]:VOLTage:POJump	177
	[:INPut]:CURRent	177
	[:INPut]:CURRent:RANGe.....	177
	[:INPut]:CURRent:AUTO	178
	[:INPut]:CURRent:CONFig.....	178
	[:INPut]:CURRent:POJump	179
	[:INPut]:CURRent:EXTSensor:CONFig<x>	179
	[:INPut]:CURRent:EXTSensor:POJump<x>	180
	[:INPut]:CURRent:SRATio[:ALL<x>]	180
	[:INPut]:CURRent:SRATio:ELEMent<x><y>	181
	[:INPut]:RCONfig	181
	[:INPut]:SCALing	181
	[:INPut]:SCALing[:STATe].....	182
	[:INPut]:SCALing:{VT CT SFACtor}:ELEMent <x>	182
	[:INPut]:SCALing:{VT CT SFACtor}[:ALL]	183
	[:INPut]:SYNChronize	183
	[:INPut]:FILTer.....	183
	[:INPut]:FILTer:LINE	184
	[:INPut]:FILTer:FREQuency.....	184
	[:INPut]:POVer	185
	[:INPut]:CRANge	185
	[:INPut]:ZERO	186

INTEGrate	:INTEGrate	187
commands	:INTEGrate:MODE	187
	:INTEGrate:FUNCTion	188
	:INTEGrate:TIMer	188
	:INTEGrate:STARt	188
	:INTEGrate:STOP	189
	:INTEGrate:RESet	189
	:INTEGrate:STATe	189
	:INTEGrate:ELEMent	189
Math commands	:MATH	191
MEASure	:MEASure	192
commands	:MEASure:AVERaging	192
	:MEASure:AVERaging[:STATe]	192
	:MEASure:AVERaging:TYPE	193
	:MEASure:AVERaging:COUNT	193
	:MEASure:MHOLD	193
NUMeric	:NUMeric	195
commands	:NUMeric:FORMat	195
	:NUMeric:NORMal	196
	:NUMeric[:NORMal]:VALue	196
	:NUMeric[:NORMal]:NUMber	198
	:NUMeric[:NORMal]:ITEM<x>	198
	:NUMeric[:NORMal]:PRESet	202
	:NUMeric[:NORMal]:CLEar	204
	:NUMeric[:NORMal]:DELete	205
	:NUMeric[:NORMal]:HEADer	205
	:NUMeric:LIST	206
	:NUMeric:LIST:VALue	206
	:NUMeric:LIST:NUMber	207
	:NUMeric:LIST:ORDer	208
	:NUMeric:LIST:SElect	208
	:NUMeric:LIST:ITEM<x>	209
	:NUMeric:LIST:PRESet	209
	:NUMeric:LIST:CLEar	211
	:NUMeric:LIST:DELete	211
	:NUMeric:HOLD	212

RATE commands	:RATE	214
	:RATE:AUTO	214
	:RATE:AUTO:TIMEout.....	214
	:RATE:AUTO:SYNChronize.....	215
RECall commands	:RECall:NUMber.....	216
	:RECall[:NORMAl]:VALue	216
	:RECall:LIST:VALue	217
	:RECall:PANel.....	217
STATus	:STATus	218
commands	:STATus:CONDition.....	218
	:STATus:EESE.....	218
	:STATus:EESR.....	219
	:STATus:ERRor	219
	:STATus:FILTer<x>	220
	:STATus:QENable	221
	:STATus:QMESsage	221
STORe	:STORe	223
commands	:STORe[:STATe]	223
	:STORe:INTerval	223
	:STORe:PANel	224
SYSTem	:SYSTem	225
commands	:SYSTem:BRIGhtness.....	225
	:SYSTem:COMMunicate:COMMand	226
	:SYSTem:COMMunicate:ETHernet:MACaddress	226
	:SYSTem:FIRMware:DATE	226
	:SYSTem:KEY:BEEPer.....	227
	:SYSTem:KLOCK.....	227
	:SYSTem:MODEL	228
	:SYSTem:RESolution	228
	:SYSTem:SERial	228
	:SYSTem:VERsion[:FIRMware].....	228

SCPI Commands

*CLS	151
*ESE	151
*ESR	152
*IDN	152
*OPC	152
*OPT	153
*RST	153
*SRE	153
*STB	154
*TRG	154

*CLS

Set →

Description Clears the standard event status register, extended event status register, and error queue.

Syntax *CLS

*ESE

Set →

→ Query

Description Sets or returns the ESER (Event Status Enable Register) contents.

Syntax *ESE <NR1>

Query Syntax *ESE?

Parameter/ <NR1> 0~255
Return parameter

Example *ESE 65
 Set the ESER to 01000001
 *ESE?
 ->130
 ESER=10000010

***ESR** → **Query**

Description	Returns and clears the SESR (Standard Event Status Register).
Query Syntax	*ESR?
Return parameter	<NR1> 0~255
Example	*ESR? ->198 SESR=11000110

***IDN** → **Query**

Description	Returns the manufacturer, model number, serial number, and system version of the instrument.
Query Syntax	*IDN?
Return parameter	<String>
Example	*IDN? ->GWInstek,GPM-8330-60, GXXXXXXXXX,V1.00

***OPC**
Set →
 → Query

Description	Sets or returns the operation complete bit (bit0) in SERS (Standard Event Status Register) when all pending operations are completed.
Syntax	*OPC
Query Syntax	*OPC?
Return parameter	<NR1>0 Operation isn't completed.
	<NR1>1 Operation is completed.
Example	*OPC? Returns 1.

***OPT**

→ Query

Description	Returns the installed option.
Query Syntax	*OPT?
Return parameter	<String> C1:GBIP C2:RS232 C3:USB Device C7:Ethernet EX1:External Sensor 1 (2.5 V/5 V/10 V) EX2:External Sensor 2 (50 mV/100 mV/ 200 mV/500 mV/1 V/2 V) G5:Harmonic measurement DA12:4 channel D/A output

Example *OPT?
 ->C1,C2,C3,C7,EX1,EX2,G5,DA12

***RST**

Set →

Description	Initializes the settings
Syntax	*RST

Set →

***SRE**

→ Query

Description	Sets or returns SRER (Service Request Enable Register)
Syntax	*SRE <NR1>
Query Syntax	*SRE?
Parameter/ Return parameter	<NR1> 0~255

Example *SER 7
 Set the the SRER to 00000111
 *SRE?
 ->3
 SRER=00000011

***STB** → Query

Description Returns the SBR (Status Byte Register) contents.

Query Syntax *STB?

Return parameter <NR1> 0~255

Example *STB ?
 ->34
 SBR=00100010

***TRG** Set →

Description Executes single measurement (the same operation as when Trigger is pressed).

Syntax *TRG

AOUTput Commands

:AOUTput.....	155
:AOUTput[:NORMal]:CHANnel<x>	155
:AOUTput[:NORMal]:IRTime	156
:AOUTput[:NORMal]:MODE<x>.....	156
:AOUTput[:NORMal]:PRESet	157
:AOUTput[:NORMal]:RATE<x>	157
:AOUTput:DIGital:MODE	158
:AOUTput:DIGital:OUTPut	158
:AOUTput:DIGital:SETup	159

:AOUTput

→ Query

Description	Returns all D/A output settings.
Query Syntax	:AOUTput?
Return parameter	<String>

:AOUTput[:NORMal]:CHANnel<x>

Set →

→ Query

Description	Sets or returns a D/A output item.
Syntax	:AOUTput[:NORMal]:CHANnel<X> {<Function>[,<Element>]}
Query Syntax	:AOUTput[:NORMal]:CHANnel<X>?
Parameter/	<x> 1 to 12 (channel)
Return parameter	<Function> U I P S Q LAMBda PHI UPeak IPeak FU FI WH WHP WHM AH AHP AHM NONE
	<Element> 1~3 SIGMA
Example	:AOUTPUT:NORMAL:CHANNEL1 NONE Turns D/A channel1 output off (0V) :AOUTPUT:NORMAL:CHANNEL1? ->:AOUTPUT:NORMAL:CHANNEL1 I,1

Set →

→ Query

:AOUTput[:NORMal]:IRTime

Description	Sets or returns the rated integration time that is used in the D/A output of the integrated value.	
Syntax	:AOUTput[:NORMal]:IRTime {<NRF>,<NRF>,<NRF>}	
Query Syntax	:AOUTput[:NORMal]:IRTime?	
Parameter/	1st <NRF>	0~9999(hour)
Return parameter	2nd <NRF>	0~59(minute)
	3rd <NRF>	0~59(second)
Example	:AOUTPUT:NORMAL:IRTIME 1,1,10 :AOUTPUT:NORMAL:IRTIME? ->:AOUTPUT:NORMAL:IRTIME 1,1,10	

Set →

→ Query

:AOUTput[:NORMal]:MODE<x>

Description	Sets or returns a D/A range mode. (Remote Control Only)	
Syntax	:AOUTput[:NORMal]:MODE<x> {FIXed MANual COMPare}	
Query Syntax	:AOUTput[:NORMal]:MODE<x>?	
Parameter/	<x>	1 to 12 (channel)
Return parameter	FIXed	Fixed range mode.
	MANual	Manual range mode.
	COMPare	Comparator mode.
Example	:AOUTPUT:NORMAL:MODE1 FIXED :AOUTPUT:NORMAL:MODE1? ->:AOUTPUT:NORMAL:MODE1 FIXED	



Note

- **FIXed** = Fixed range mode (default value)
Outputs +5 V when the rated value of each measurement function is received.
- **MANual** = Manual range mode
The displayed values of the measurement function when +5 V and -5 V are output as D/A output can be set to any values of your choice. This enables the D/A output to be expanded or reduced for each channel (D/A zoom).
- **COMPare** = Comparator mode
By comparing with the comparator limits, this instrument outputs +5 V, 0 V, or -5 V.

:AOUTput[:NORMal]:PRESet



Description	Sets the D/A output items to their default values.	
Syntax	:AOUTput[:NORMal]:PRESet {NORMal INTEGrate}	
Parameter	NORMal	CH1:U1, CH2:U2, CH3:U3, CH4:UΣ, CH5:I1, CH6:I2, CH7:I3, CH8:IΣ, CH9:P1, CH10:P2, CH11:P3, CH12:PΣ
	INTEGrate	CH1:P1, CH2:P2, CH3:P3, CH4:PΣ, CH5:WP1, H6:WP2, CH7:WP3, CH8:WPΣ, CH9:q1, CH10:q2, CH11:q3, CH12:qΣ
Example	:AOUTPUT:NORAML:PRESET NORMAL	

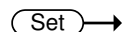

:AOUTput[:NORMal]:RATE<x>

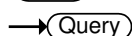

Description	Sets or returns the maximum and minimum values for when the D/A output is in manual range mode. (Remote Control Only)	
Syntax	:AOUTput[:NORMal]:RATE<x> {<NRf>,<NRf>}	
Query Syntax	:AOUTput[:NORMal]:RATE<x>?	
Parameter/ Return parameter	<x>	1 to 12 (channel)
	<NRf>	-9.999E+12~9.999E+12

Example :AOUTPUT:RATE1 100,-100
 :AOUTPUT:RATE1?
 ->:AOUTPUT:NORMAL:RATE1 100.0E+00,-100.0E+00



Note

- When the D/A output is in manual range mode
Set the rated value for +5 V output and then that for -5 V output.
- When the D/A output is in fixed range mode
There is no need to set these values. (The values do not affect the output operation.)
- When the D/A output is in comparator mode
Set the upper limit and then the lower limit.

:AOUTput:DIGital:MODE (Set) →
→ (Query)

Description Sets the application mode of digital I/O (Remote Control Only).

Syntax :AOUTput:DIGital:MODE {IO|4094}

Query Syntax :AOUTput:DIGital:MODE?

Parameter/ Return parameter	IO	Sets the digital I/O to IO mode.
	4094	Sets the digital I/O to 4094 (serial to parallel) mode.

Example :AOUTPUT:DIGITAL:MODE IO
 :AOUTPUT:DIGITAL:MODE?
 ->:AOUTPUT:DIGITAL:MODE IO

:AOUTput:DIGital:OUTPut (Set) →

Description When the 4094 mode (serial to parallel) is selected for digital I/O, make use of this command to set output status.

Syntax :AOUTput:DIGital:OUTPut {<NR1>,<Boolean>}

Parameter	<NR1> <Boolean>	0~255 (serial input data) 0,1 (strobe pulse)
Example	:AOUTPUT:DIGITAL:MODE 4094 :AOUTPUT:DIGITAL:OUTPUT 10,1	

:AOUTput:DIGital:SETup (Set) →

Description	When the IO mode is selected for digital I/O,make use of this command to set output status.	
Syntax	:AOUTput:DIGital:SETup {<Boolean>}	
Parameter	<Boolean>	0,1 (OUT1, OUT2, OUT3, OOUT4)
Example	:AOUTPUT:DIGITAL:MODE IO :AOUTPUT:DIGITAL:SETUP 0,1,0,1 Sets OUT1 to low, OUT2 to high, OUT3 to low, OUT4 to high	

COMMunicate Commands

:COMMunicate	160
:COMMunicate:HEADer	160
:COMMunicate:LOCKout	161
:COMMunicate:REMOte	161
:COMMunicate:STATus	162
:COMMunicate:VERBose	162

:COMMunicate → Query

Description	Returns all communication settings.
Query Syntax	:COMMunicate?
Return parameter	<String>

Set →

:COMMunicate:HEADer → Query

Description	Sets or returns whether headers are attached to query responses.	
Syntax	:COMMunicate:HEADer {<Boolean> OFF ON}	
Query Syntax	:COMMunicate:HEADer?	
Parameter	<Boolean>0	OFF
	<Boolean>1	ON
Return parameter	0	Returns without a header.
	1	Returns with a header.
Example	:COMMUNICATE:HEADER ON :COMMUNICATE:HEADER? ->:COMMUNICATE:HEADER 1	



Note

Example of a response with a header

```
:INPUT:VOLTAGE:RANGE 150.0E+00
```

Example of a response without a header

```
150.0E+00
```

:COMMunicate:LOCKout

Set →

→ Query

Description	Sets or returns local lockout.	
Syntax	:COMMunicate:LOCKout {<Boolean> OFF ON}	
Query Syntax	:COMMunicate:LOCKout?	
Parameter	<Boolean>0	OFF
	<Boolean>1	ON
Return parameter	0	Disable the local key.
	1	Enable the local key.
Example	:COMMUNICATE:LOCKOUT ON :COMMUNICATE:LOCKOUT? -> :COMMUNICATE:LOCKOUT 1	

Set →

→ Query

:COMMunicate:REMote

Description	Sets or returns the GPM-8320-60/8330-60 series to remote or local mode. ON is remote mode.	
Syntax	:COMMunicate:REMote {<Boolean> OFF ON}	
Query Syntax	:COMMunicate:REMote?	
Parameter	<Boolean>0	OFF
	<Boolean>1	ON
Return parameter	0	Turn the remote function off.
	1	Turn the remote function on.

Example :COMMUNICATE:REMOTE ON
:COMMUNICATE:REMOTE?
->:COMMUNICATE:REMOTE 1

:COMMunicate:STATus → Query

Description Returns and clears the line-specific status.(Only for RS-232)

Query Syntax :COMMunicate:STATUS?

Return parameter (each status bit)	Bit 0	Parity error.
	Bit 1	Framing error.
	Bit 2	Noise error Break character detection.
	Bit 3 and higher	Always zero.

Example :COMMUNICATE:STATUS?
->0



Note

- When an event occurs, the corresponding bit is set in the status.
- When the bit is read, it is cleared.
- Zero is returned for interfaces other than RS-232.

:COMMunicate:VERBose Set →
→ Query

Description Sets or returns whether the response to a query is returned fully spelled out or in its abbreviated form.

Syntax :COMMunicate:VERBose {<Boolean>|OFF | ON}

Query Syntax :COMMunicate:VERBose?

Parameter <Boolean>0 OFF
<Boolean>1 ON

Return parameter 0 Turn the verbose function off.
1 Turn the verbose function on.

Example :COMMUNICATE:VERBOSE ON
 :COMMUNICATE:VERBOSE?
 ->:COMMUNICATE:VERBOSE 1



Note

Example of a response fully spelled out

:INPUT:VOLTAGE:RANGE 150.0E+00

Example of a response in abbreviated form

:VOLT:RANG 150.0E+00

DISPlay Commands

:DISPlay.....	164
:DISPlay:NORMAl	164
:DISPlay[:NORMAl]:ITEM<x>	164
:DISPlay:INTegrate:ITEM<x>	166
:DISPlay:PAGE	167
:DISPlay:NUMeric[:NORMAl]:FORMat.....	167
:DISPlay:NUMeric[:NORMAl]:PAGE	168

:DISPlay → Query

Description Returns all display settings.

Query Syntax :DISPlay?

Return parameter <String>

:DISPlay:NORMAl → Query

Description Returns all normal measurement data display settings.

Query Syntax :DISPlay:NORMAl?

Return parameter <String>

Set →

:DISPlay[:NORMAl]:ITEM<x> → Query

Description Sets or returns a normal measurement data display item. Refer to page 81 for details.

Syntax :DISPlay[:NORMAl]:ITEM<x>
<Function>[,<Element>]}

Query Syntax :DISPlay[:NORMAl]:ITEM<x>?

Parameter/	<x>	1 to 10 (display).
Return parameter	<Function>	U UPPeak UMPeak I IPPeak IMPeak P PPPeak PMPeak S Q LAMBda CFU CFI PHI FU FI UTHD ITHD MATH MCR EFFi
	<Element>	{<NRf> SIGMa} (<NRf> = 1 to 3)

Example :DISPLAY:NORMAL:ITEM1 U,1
:DISPLAY:NORMAL:ITEM1?
->:DISPLAY:NORMAL:ITEM1 U,1

<Function>	Function	GPM-8320-60/ 8330-60 Indicator
U	Voltage V	[V]
UPPeak	Maximum voltage: V+pk	[V+pk]
UMPeak	Minimum voltage: V-pk	[V-pk]
I	Current I	[I]
IPPeak	Maximum current: I+pk	[I+pk]
IMPeak	Minimum current: I-pk	[I-pk]
P	Active power P	[P]
PPPeak	Maximum power: P+pk	[P+pk]
PMPeak	Minimum power: P-pk	[P-pk]
S	Apparent power S	[VA]
Q	Reactive power Q	[VAR]
LAMBda	Power factor λ	[PF]
CFU	Voltage factor λ	[CFV]
CFI	Current factor λ	[CFI]
PHI	Phase difference Φ	[DEG]
FU	Voltage frequency fV	[VHz]
FI	Current frequency fI	[IHz]
UTHD	Total harmonic distortion of voltage Vthd	[THDV]

ITHD	Total harmonic distortion of current Ithd	[THDI]
MATH	Mathematical Computation	[MATH]
MCR	Maximum Current Ratio	[MCR]
EFFi	Power Efficiency	[EFFI]

Set →
 → Query

:DISPlay:INTEgrate:ITEM<x>

Description Sets or returns a Integrate measurement data display item. Refer to page 103 for details.

Syntax :DISPlay:INTEgrate:ITEM<x>
 <Function>[,<Element>]}

Query Syntax :DISPlay:INTEgrate:ITEM<x>?

Parameter/	<x>	1 to 2(display).
Return parameter	<Function>	{WHP WHM WHAVG AHP AHM AHAVG U I}
	<Element>	1 (If <Element> is omitted, the element is set to 1) (For the GPM-8320-60/8330-60, only set to 1 or omitted).

Example :DISPLAY:INTEGRATE:ITEM1 WHP,1
 :DISPLAY:INTEGRATE:ITEM1?
 ->:DISPLAY:INTEGRATE:ITEM1 WHP,1

<Function>	Function	GPM-8320-60/8330-60 Indicator
------------	----------	-------------------------------

WHP	Positive watt hour WP+	[WP+]
WHM	Positive watt hour WP-	[WP-]
WHAVG	Average power	[P(avg)]
AHP	Positive ampere hour q+	[q+]
AHM	Positive ampere hour q	[q-]
AHAVG	Average current	[q(avg)]
U	Voltage V	[V]

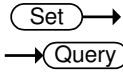

:DISPlay:NUMeric[:NORMal]:PAGE

Description	Sets or queries the displayed page of the numeric display	
Syntax	:DISPlay:NUMeric[:NORMal]:PAGE{<NRf>}	
Parameter/	<NRf>	1 to 4 (Page number)
Return parameter		
Example	:DISPLAY:NUMERIC:NORMAL:PAGE 1 :DISPLAY:NUMERIC:NORMAL:PAGE? ->:DISPLAY:NUMERIC:NORMAL:PAGE 1	

HARMonics Command

:HARMonics.....	169
:HARMonics:DISPlay.....	169
:HARMonics:DISPlay[:STATe]	169
:HARMonics:DISPlay:ORDer	170
:HARMonics:PLLSource	170
:HARMonics:ORDer	171
:HARMonics:THD.....	171

:HARMonics → Query

Description	Returns all harmonic measurement settings.
Query Syntax	:HARMonics?
Return parameter	<String>

:HARMonics:DISPlay → Query

Description	Returns all harmonic measurement display settings.
Query Syntax	:HARMonics:DISPlay?
Return parameter	<String>

:HARMonics:DISPlay[:STATe] Set → → Query

Description	Sets or returns the on/off state of harmonic measurement data display.
Syntax	:HARMonics:DISPlay[:STATe] {<Boolean> OFF ON}
Query Syntax	:HARMonics:DISPlay[:STATe]?
Parameter	<Boolean>0 OFF <Boolean>1 ON

Return parameter	0	Turn the harmonic display off.
	1	Turn the harmonic display on.

Example : HARMONICS:DISPLAY:STATE OFF
 : HARMONICS:DISPLAY:STATE?
 ->:HARMONICS:DISPLAY:STATE 0

Set →
 → Query

:HARMONics:DISPlay:ORDer

Description Sets or returns the harmonic order of the harmonic component that is shown in graph->hormoics->bar page for the harmonic measurement data display.

Syntax :HARMONics:DISPlay:ORDer {<NR1>}

Query Syntax :HARMONics:DISPlay:ORDer?

Parameter/ <NR1> 1 to 50 (harmonic order).

Return parameter

Example :HARMONICS:DISPLAY:ORDER 1
 :HARMONICS:DISPLAY:ORDER?
 ->:HARMONICS:DISPLAY:ORDER 1

Set →
 → Query

:HARMONics:PLLSource

Description Sets or returns the PLL source.

Syntax :HARMONics:PLLSource {U<x>|I<x>}<x> = 1 to 3 (element)

Query Syntax :HARMONics:PLLSource?

Parameter/ U1/U2/U3 Select pll source at voltage.

Return parameter I1/I2/I3 Select pll source at current.

Example :HARMONICS:PLLSOURCE U1
 :HARMONICS:PLLSOURCE?
 ->:HARMONICS:PLLSOURCE U1

Set →
→ Query

:HARMonics:ORDer

Description	Sets or returns the maximum and minimum harmonic orders that are analyzed.	
Syntax	:HARMonics:ORDer {<NRf>,<NRf>}	
Query Syntax	:HARMonics:ORDer?	
Parameter/ Return parameter	1st <NRf> 2nd <NRf>	1 (minimum harmonic order, fixed at 1) 50 (maximum harmonic order)
Example	:HARMONICS:ORDER 1,20 :HARMONICS:ORDER? ->:HARMONICS:ORDER 1,20	

Set →
→ Query

:HARMonics:THD

Description	Sets or returns the equation used to compute the THD (total harmonic distortion).	
Syntax	:HARMonics:THD {TOTal FUNDamental OFF}	
Query Syntax	:HARMonics:THD?	
Parameter/ Return parameter	TOTal FUNDamental OFF	(CSA) (IEC)
Example	:HARMONICS:THD FUNDAMENTAL :HARMONICS:THD? ->:HARMONICS:THD FUNDAMENTAL	

HOLD Command

:HOLD

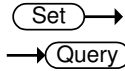

Description Sets or returns the on/off state of the output hold feature for display, communication, and other types of data.

Syntax :HOLD {<Boolean>|OFF|ON}

Query Syntax :HOLD?

Parameter	<Boolean>0	OFF
	<Boolean>1	ON

Return parameter	0	Turn the hold function off.
	1	Turn the hold function on.

Example

```
:HOLD OFF
:HOLD?
->:HOLD 0
```

INPut Commands

:INPut	173
[:INPut]:CFACtor	174
[:INPut]:WIRing	174
[:INPut]:MODE	175
[:INPut]:VOLTage	175
[:INPut]:VOLTage:RANGe	175
[:INPut]:VOLTage:AUTO	176
[:INPut]:VOLTage:CONFig	176
[:INPut]:VOLTage:POJump	177
[:INPut]:CURRent	177
[:INPut]:CURRent:RANGe	177
[:INPut]:CURRent:AUTO	178
[:INPut]:CURRent:CONFig	178
[:INPut]:CURRent:POJump	179
[:INPut]:CURRent:EXTSensor:CONFig<x>	179
[:INPut]:CURRent:EXTSensor:POJump<x>	180
[:INPut]:CURRent:SRATio[ALL<x>]	180
[:INPut]:CURRent:SRATio:ELEMent<x><y>	181
[:INPut]:RCONfig	181
[:INPut]:SCALing	181
[:INPut]:SCALing[STATE]	182
[:INPut]:SCALing:{VT CT SFACtor}:ELEMent <x>	182
[:INPut]:SCALing:{VT CT SFACtor}[ALL]	183
[:INPut]:SYNChronize	183
[:INPut]:FILTer	183
[:INPut]:FILTer:LINE	184
[:INPut]:FILTer:FREQuency	184
[:INPut]:POVer	185
[:INPut]:CRANGe	185
[:INPut]:ZERO	186

:INPut



Description	Returns all input settings.
-------------	-----------------------------

Query Syntax	:INPut?
--------------	---------

Return parameter <String>

Set →

→ Query

[:INPut]:CFACtor

Description Sets or returns the crest factor.

Syntax [:INPut]:CFACtor {3|6|A6}

Query Syntax [:INPut]:CFACtor?

Parameter/ Return parameter	3 6 A6	crest factor 3. crest factor 6. Display range expand mode (6A) for crest factor 6.
--------------------------------	--------------	--

Example
 :INPUT:CFACtor 3
 :INPUT:CFACtor?
 ->:INPUT:CFACtor 3

Set →

→ Query

[:INPut]:WIRing

Description Sets or returns the wiring system.

Syntax [:INPut]:WIRing {P1W3|P3W3|P3W4|V3A3}

Query Syntax [:INPut]:WIRing?

Parameter/ Return parameter	P1W3 P3W3 P3W4 V3A3
--------------------------------	------------------------------

Example
 :INPUT:WIRING P1W3
 :INPUT:WIRING?
 ->:INPUT:WIRING P1W3

Set →
→ Query

[:INPut]:MODE

Description	Sets or returns the voltage and current measurement mode.	
Syntax	[:INPut]:MODE {DC AC ACDC/RMS VMEan}	
Query Syntax	[:INPut]:MODE?	
Parameter/ Return parameter	DC	Select the dc measurement mode.
	AC	Select the ac measurement mode.
	ACDC/RMS	Select the acdc measurement mode.
	VMEan	Select the vmean measurement mode.
Example	<pre>:INPUT:MODE DC :INPUT:MODE? ->:INPUT:MODE DC</pre>	

→ Query

[:INPut]:VOLTage

Description	Returns all voltage measurement settings.	
Query Syntax	[:INPut]:VOLTage?	
Return parameter	<String>	

Set →
→ Query

[:INPut]:VOLTage:RANGe

Description	Sets or returns the voltage range.	
Syntax	[:INPut]:VOLTage:RANGe {<Voltage>}	
Query Syntax	[:INPut]:VOLTage:RANGe?	
Parameter/ Return parameter	<Voltage>	15, 30, 60, 150, 300, 600, 1000(V) when the crest factor is set to 3. 7.5, 15, 30, 75, 150, 300, 500(V) when the crest factor is set to 6 or 6A.

Example :INPUT:VOLTAGE:RANGE 600V
 :INPUT:VOLTAGE:RANGE?
 ->:INPUT:VOLTAGE:RANGE 600.0E+00

Set →
 → Query

[:INPut]:VOLTage:AUTO

Description	Sets or returns the voltage auto range on/off state.	
Syntax	[:INPut]:VOLTage:AUTO {<Boolean> OFF ON}	
Query Syntax	[:INPut]:VOLTage:AUTO?	
Parameter	<Boolean>0	OFF
	<Boolean>1	ON
Return parameter	0	Turn the voltage auto range function off.
	1	Turn the voltage auto range function on.

Example :INPUT:VOLTAGE:AUTO ON
 :INPUT:VOLTAGE:AUTO?
 ->:INPUT:VOLTAGE:AUTO 1

Set →
 → Query

[:INPut]:VOLTage:CONFig

Description	Sets or returns the valid voltage range.	
Syntax	[:INPut]:VOLTage:CONFig {ALL<Voltage>[,Voltage]...}	
Query Syntax	[:INPut]:VOLTage:CONFig?	
Parameter/ Return parameter	ALL	All ranges are valid.
	<Voltage>	See(:INPut:VOLTage:RANGe).

Example :INPUT:VOLTAGE:CONFIG 300,150,30
 :INPUT:VOLTAGE:CONFIG?
 ->:INPUT:VOLTAGE:CONFIG 300.0E+00,150.0E+00,
 30.0E+00

Set →
 → Query

[:INPut]:VOLTage:POJump

Description	Sets or returns the jump destination range that is used when a voltage peak over-range occurs.	
Syntax	[:INPut]:VOLTage:POJump {OFF <Voltage>}	
Query Syntax	[:INPut]:VOLTage:POJump?	
Parameter/ Return parameter	OFF <Voltage>	No jump destination voltage range. See(:INPut:VOLTage:RANGe).
Example	:INPUT:VOLTAGE:POJUMP 600V :INPUT:VOLTAGE:POJUMP? ->:INPUT:VOLTAGE:POJUMP 600.0E+00	

→ Query

[:INPut]:CURRent

Description	Returns all current measurement settings.	
Query Syntax	[:INPut]:CURRent?	
Return parameter	<String>	

Set →
 → Query

[:INPut]:CURRent:RANGe

Description	Sets or returns the current range.	
Query	[:INPut]:CURRent:RANGe {<Current> (EXTernal<x>,<Voltage>)}	
Query Syntax	[:INPut]:CURRent:RANGe?	
Parameter/ Return parameter	<x> <Current>	1,2(EXT1,EXT2) 1, 2, 5, 10, 20, 60(A) when the crest factor is set to 3. 0.5, 1, 2.5, 5, 10, 30(A) when the crest factor is set to 6 or 6A.
	EXTernal1	2.5, 5, 10(V) when the crest factor is set to 3.

<Voltage>	1.25, 2.5, 5(V) when the crest factor is set to 6 or 6A.
EXTernal2 <Voltage>	50, 100, 200, 500, (mV), 1, 2(V) when the crest factor is set to 3.
	25, 50, 100, 250, (mV), 0.5, 1 (V) when the crest factor is set to 6 or 6A.

Example

```
:INPUT:CURRENT:RANGE 20A
:INPUT:CURRENT:RANGE?
->:INPUT:CURRENT:RANGE 20.0E+00
:INPUT:CURRENT:RANGE EXTERNAL1,10V
:INPUT:CURRENT:RANGE?
-> :INPUT:CURRENT:RANGE EXTERNAL1,10.0E+00
```

[:INPut]:CURRent:AUTO

Set →

→ Query

Description	Sets or returns the current auto range on/off state.	
Syntax	[:INPut]:CURRent:AUTO {<Boolean> OFF ON}	
Query Syntax	[:INPut]:CURRent:AUTO?	
Parameter	<Boolean>0	OFF
	<Boolean>1	ON
Return parameter	0	Turn the current auto range function off.
	1	Turn the current auto range function on.

Example

```
:INPUT:CURRENT:AUTO ON
:INPUT:CURRENT:AUTO?
->:INPUT:CURRENT:AUTO 1
```



[:INPut]:CURRent:CONFig

Set →

→ Query

Description	Sets or returns the valid current range.	
Syntax	[:INPut]:CURRent:CONFig {ALL <Current>[,Current]...}	

Query Syntax	[:INPut]:CURRent:CONFig?	
Parameter/ Return parameter	ALL <Current>	All ranges are valid. See(:INPut:CURRent:RANGe).
Example	:INPUT:CURRENT:CONFIG 20,10,1 :INPUT:CURRENT:CONFIG? ->:INPUT:CURRENT:CONFIG 20.0E+00,10.0E+00, 1.0E+00	

		 
[:INPut]:CURRent:POJump		
Description	Sets or returns the jump destination range that is used when a current peak over-range occurs.	
Syntax	[:INPut]:CURRent:POJump {OFF <Current>}	
Query Syntax	[:INPut]:CURRent:POJump?	
Parameter/ Return parameter	OFF <Current >	No jump destination current range. See(:INPut:CURRent:RANGe).
Example	:INPUT:CURRENT:POJUMP 20A :INPUT:CURRENT:POJUMP? ->:INPUT:CURRENT:POJUMP 20.0E+00	

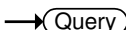
		 
[:INPut]:CURRent:EXTSensor:CONFig<x>		
Description	Sets or returns the valid external current sensor range.	
Syntax	[:INPut]:CURRent:EXTSensor:CONFig<x> {ALL <Voltage>[,Voltage]...}	
Query Syntax	[:INPut]:CURRent:EXTSensor:CONFig<x>?	
Parameter/ Return parameter	<x> ALL <Voltage>	1,2(EXT1,EXT2), If <x> is omitted, by default sets or returns EXT2 config. All ranges are valid. See(:INPut:CURRent:RANGe).

Example :INPUT:CURRENT:EXTSENSOR:CONFIG1 2,0.5,0.1
 :INPUT:CURRENT:EXTSENSOR:CONFIG1?
 ->:INPUT:CURRENT:EXTSENSOR:CONFIG1
 2.00E+00,500.0E-03,100.0E-03

(Set) →

[:INPut]:CURRent:EXTSensor:POJump<x> → (Query)

Description Sets or returns the jump destination range that is used when a current peak over-range occurs.

Syntax [:INPut]:CURRent:EXTSensor:POJump<x>
 {OFF|<Voltage>}

Query Syntax [:INPut]:CURRent:EXTSensor:POJump<x>?

Parameter/ Return parameter	<x>	1,2(EXT1,EXT2), If <x> is omitted, by default sets or returns EXT2 config.
	OFF	No jump destination current range.
	<Voltage>	See(:INPut:CURRent:RANGe).

Example :INPUT:CURRENT:EXTSENSOR:POJUMP1 2V
 :INPUT:CURRENT:EXTSENSOR:POJUMP1?
 ->:INPUT:CURRENT:EXTSENSOR:POJUMP1
 2.00E+00

(Set) →

[:INPut]:CURRent:SRATio[:ALL<x>] → (Query)

Description Collectively sets the external current sensor conversion ratios of all elements.

Syntax [:INPut]:CURRent:SRATio[:ALL<x>]

Query Syntax [:INPut]:CURRent:SRATio[:ALL<x>]?

Parameter/ Return parameter	<NRf>	0.001-9999
--------------------------------	-------	------------

[[:INPut]:CURRent:SRATio:ELEMent<x><y>  

Description	Sets or returns the external current sensor conversion ratio of the specified element.
Syntax	[[:INPut]:CURRent:SRATio:ELEMent<x> <y>
Query Syntax	[[:INPut]:CURRent:SRATio:ELEMent<x><y>?
Parameter/ Return parameter	<x> 1 to 3 (element) <y> 1,2 (EXT1,EXT2)
Example	:INPUT:CURRENT:SRATIO:ELEMENT 10 :INPUT:CURRENT:SRATIO:ELEMENT? ->:INPUT:CURRENT:SRATIO:ELEMENT1 EXT1,10.000

[[:INPut]:RCONfig  

Description	Sets or returns the on/off state of the range configuration (valid range selection) feature.
Syntax	[[:INPut]:RCONfig {<Boolean> OFF ON}
Query Syntax	[[:INPut]:RCONfig?
Parameter	<Boolean>0 OFF <Boolean>1 ON
Return parameter	0 Turn the range configuration feature off. 1 Turn the range configuration feature on.
Example	:INPUT:RCONFIG ON :INPUT:RCONFIG? ->:INPUT:RCONFIG 1

[[:INPut]:SCALing 

Description	Returns all scaling settings.
Query Syntax	[[:INPut]:SCALing?
Return parameter	<String>

Set →
 → Query

[:INPut]:SCALing[:STATe]

Description	Sets or returns the scaling on/off state.	
Syntax	[:INPut]:SCALing[:STATe] {<Boolean> OFF ON}	
Query Syntax	[:INPut]:SCALing[:STATe]?	
Parameter	<Boolean>0	OFF
	<Boolean>1	ON
Return parameter	0	Turn the scaling function off.
	1	Turn the scaling function on.
Example	:INPUT:SCALING:STATE ON :INPUT:SCALING:STATE? ->:INPUT:SCALING:STATE 1	

Set →
 → Query

[:INPut]:SCALing:{VT|CT|SFACtor}:ELEMEnt <x>

Description	Sets or returns the VT ratio, CT ratio, or power coefficient of the specified element.	
Syntax	[:INPut]:SCALing:{VT CT SFACtor}:ELEMEnt<x> {<NRF>}	
Query Syntax	[:INPut]:SCALing:{VT CT SFACtor}:ELEMEnt<x>?	
Parameter/	<x>	<x> = 1 to 3 (element)
Return parameter	<NRF>	0.001 to 9999
Example	:INPUT:SCALING:VT:ELEMENT1 10 :INPUT:SCALING:VT:ELEMENT1? ->:INPUT:SCALING:VT:ELEMENT1 10	

`[[:INPut]:SCALing:{VT|CT|SFACtor}[:ALL]` (Set) →
→ (Query)

Description Collectively sets the VT ratio, CT ratio, or power coefficient of all elements.

Syntax `[[:INPut]:SCALing:{VT|CT|SFACtor}[:ALL]`

Query Syntax `[[:INPut]:SCALing:{VT|CT|SFACtor}[:ALL]?`

**Parameter/
Return parameter** `<NRf>` 0.001 to 9999

`[[:INPut]:SYNChronize` (Set) →
→ (Query)

Description Sets or returns the synchronization source.

Syntax `[[:INPut]:SYNChronize {VOLTage|CURRent|OFF}`

Query Syntax `[[:INPut]:SYNChronize?`

Parameter/ Return parameter	VOLTage	Select the voltage synchronization source.
	CURRent	Select the current synchronization source.
	OFF	Select the off synchronization source.

Example `:INPUT:SYNCHRONIZE VOLTAGE`
`:INPUT:SYNCHRONIZE?`
`->:INPUT:SYNCHRONIZE VOLTAGE`

`[[:INPut]:FILTer` → (Query)

Description Returns all input filter settings.

Query Syntax `[[:INPut]:FILTer?`

Return parameter `<String>`

Set →

→ Query

[:INPut]:FILTer:LINE

Description	Sets or returns the line filter.	
Syntax	[:INPut]:FILTer:LINE {<Boolean> OFF ON}	
Query Syntax	[:INPut]:FILTer:LINE?	
Parameter	<Boolean>0	OFF
	<Boolean>1	ON
Return parameter	0	Turn the line filter function off.
	1	Turn the line filter function on.
Example	:INPUT:FILTER:LINE OFF :INPUT:FILTER:LINE? ->:INPUT:FILTER:LINE 0	

Set →

→ Query

[:INPut]:FILTer:FREQuency

Description	Sets or returns the frequency filter.	
Syntax	[:INPut]:FILTer:FREQuency {<Boolean> OFF ON}	
Query Syntax	[:INPut]:FILTer:FREQuency?	
Parameter	<Boolean>0	OFF
	<Boolean>1	ON
Return parameter	0	Turn the frequency filter function off.
	1	Turn the frequency filter function on.
Example	:INPUT:FILTER:FREQUECNY OFF :INPUT:FILTER:FREQUECNY? ->:INPUT:FILTER:FREQUECNY 0	

[:INPut]:POVer → Query

Description	Returns the peak over-range information.	
Query Syntax	[:INPut]:POVer?	
Return parameter	Bit 7 6 5 4 3 2 1 0	Voltage peak over-range is occurring.
	I3 U3 I2 U2 I1 U1	Current peak over-range is occurring.
Example	:INPUT:POVER? ->:INPUT:POVER 1	

[:INPut]:CRANge → Query

Description	Sets or returns the check range status.	
Query Syntax	[:INPut]:CRANge?	
Return parameter	Bit0	The voltage is at the condition for reducing the auto range or less.
	Bit1	The voltage exceeds the condition for raising the auto range.
	Bit2	The voltage is over-range.
	Bit3	The voltage is peak over-range.
	Bit4	The current is at the condition for reducing the auto range or less.
	Bit5	The current exceeds the condition for raising the auto range.
	Bit6	The current is over-range.
	Bit7	The current is peak over-range.
Example	:INPUT:CRANGE? ->:INPUT:CRANGE 8 (Indicate the voltage is peak over-range)	

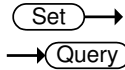

[:INPut]:ZERO

Description	Sets or returns the zero state.	
Syntax	[:INPut]:ZERO {<Boolean> OFF ON}	
Query Syntax	[:INPut]:ZERO?	
Parameter	<Boolean>0	OFF
	<Boolean>1	ON
Return parameter	0	Turn the zero function off.
	1	Turn the zero function on.
Example	:INPUT:ZERO OFF :INPUT:ZERO? ->:INPUT:ZERO 0	

INTEGrate Commands

:INTEGrate	187
:INTEGrate:MODE.....	187
:INTEGrate:FUNCTion	188
:INTEGrate:TIMer	188
:INTEGrate:STARt	188
:INTEGrate:STOP	189
:INTEGrate:RESet	189
:INTEGrate:STATe	189
:INTEGrate:ELEMent	189

:INTEGrate → Query

Description	Returns all integration settings.
Query Syntax	:INTEGrate?
Return parameter	<String>

:INTEGrate:MODE Set → → Query

Description	Sets or returns the integration mode.	
Syntax	:INTEGrate:MODE {MANUal NORMal CONTInuous}	
Query Syntax	:INTEGrate:MODE?	
Parameter/ Return parameter	MANUal	Manual integration mode.
	NORMal	Standard integration mode.
	CONTInuous	Continuous integration mode.
Example	:INTEGRATE:MODE MANUAL :INTEGRATE:MODE? ->:INTEGRATE:MODE MANUAL	

Set →

→ Query

:INTEGrate:FUNctIon

Description	Sets or returns the integration function.	
Syntax	:INTEGrate:FUNctIon {WATT AMPEre}	
Query Syntax	:INTEGrate:FUNctIon?	
Parameter/ Return parameter	WATT	Select the integration function watt.
	AMPEre	Select the integration function ampere.
Example	:INTEGRATE:FUNCTION WATT	
	:INTEGRATE:FUNCTION?	
	->:INTEGRATE:FUNCTION WATT	

Set →

→ Query

:INTEGrate:TIMer

Description	Sets or returns the integration timer value.	
Syntax	:INTEGrate:TIMer {<NRf>,<NRf>,<NRf>}	
Query Syntax	:INTEGrate:TIMer?	
Parameter/ Return parameter	1st <NRf>	0 to 9999 (hours)
	2nd <NRf>	0 to 59 (minutes)
	3rd <NRf>	0 to 59 (seconds)
Example	:INTEGRATE:TIMER 1,0,0	
	:INTEGRATE:TIMER?	
	->:INTEGRATE:TIMER 1,0,0	

Set →

:INTEGrate:STARt

Description	Starts integration.
Syntax	:INTEGrate:STARt
Example	:INTEGRATE:STARt

:INTEGrate:STOP

Set →

Description Stops integration.

Syntax :INTEGrate:STOP

Example :INTEGRATE:STOP

:INTEGrate:RESet

Set →

Description Resets the integrated value.

Syntax :INTEGrate:RESet

Example :INTEGRATE:RESET

:INTEGrate:STATe

→ Query

Description Returns the integration status.

Query Syntax :INTEGrate:STATe?

Return parameter	ERRor	Integration overflows.
	RESet	Integration resets.
	STARt	Integration is in progress.
	STOP	Integration stops.
	TIMeup	Integration stops due to integration timeout.

Example :INTEGRATE:STATE?
->RESET

:INTEGrate:ELEMent

Set →

→ Query

Description Sets or display each element and all measured values

Syntax :INTEGRATE:ELEMENT

Query Syntax :INTEGRATE:ELEMENT?

Example :INTEGRATE:ELEMENT 1-3/SIGMA/All

:INTEGRATE:ELEMENT? 1-3/SIGMA/All

Math Commands

Set →

→ Query

:MATH

Description	Sets or returns the MATH equation.	
Syntax	:MATH{<Equation>[,<Parameter1>][,<Element1>][,<Parameter2>][,<Element2>]}	
Query Syntax	:MATH{<Equation>[,<Parameter1>][,<Element1>][,<Parameter2>][,<Element2>]}?	
Parameter/ Return parameter	Equation	{ADD SUB MUL DIV DIVA DIVB}
	Parameter1,2	{U P S Q}
	Element1,2	1 to 3, SIGMa
Example	:MATH ADD Set math equation to A+B :MATH? ->:MATH ADD	

<Equation>	Definition
ADD	A+B
SUB	A-B
MUL	AxB
DIV	A/B
DIVA	A/B ²
DIVB	A ² /B
<Parameter1,2>	Definition
U	Voltage U
I	Current I
P	Active power P
S	Apparent power S
Q	Reactive power Q

MEASure Commands

:MEASure	192
:MEASure:AVERaging	192
:MEASure:AVERaging[:STATe]	192
:MEASure:AVERaging:TYPE	193
:MEASure:AVERaging:COUNT	193
:MEASure:MHOLD	193

:MEASure → Query

Description Returns all measured and computed data output settings.

Query Syntax :MEASure?

Return parameter <String>

:MEASure:AVERaging → Query

Description Returns all averaging settings.

Query Syntax :MEASure:AVERaging?

Return parameter <String>

:MEASure:AVERaging[:STATe] Set → → Query

Description Sets or returns the on/off state of averaging.

Syntax :MEASure:AVERaging[:STATe] {<Boolean>|OFF|ON}

Query Syntax :MEASure:AVERaging[:STATe]?

Parameter <Boolean>0 OFF
<Boolean>1 ON

Return parameter 0 Turn the averaging function off.
1 Turn the averaging function on.

Example :MEASURE:AVERAGING:STATE ON
 :MEASURE:AVERAGING:STATE?
 ->:MEASURE:AVERAGING:STATE 1

:MEASure:AVERaging:TYPE

Set →
 → Query

Description Sets or returns the averaging type.

Syntax :MEASure:AVERaging:TYPE {LINear|EXPonent}

Query Syntax :MEASure:AVERaging:TYPE?

Parameter/ Return parameter	LINear	Select averaging type to linear.
	EXPonent	Select averaging type to exponent.

Example :MEASURE:AVERAGING:TYPE LINEAR
 :MEASURE:AVERAGING:TYPE?
 ->:MEASURE:AVERAGING:TYPE LINEAR

:MEASure:AVERaging:COUNT

Set →
 → Query

Description Sets or returns the averaging coefficient.

Syntax :MEASure:AVERaging:COUNT {<NRf>}

Query Syntax :MEASure:AVERaging:COUNT?

Parameter/ Return parameter	<NRf>	8,16,32,64
--------------------------------	-------	------------

Example :MEASURE:AVERAGING:COUNT 8
 :MEASURE:AVERAGING:COUNT?
 ->:MEASURE:AVERAGING:COUNT 8

:MEASure:MHOLD

Set →
 → Query

Description Sets the MAX hold on/off state.

Syntax :MEASure:MHOLD {<Boolean>|OFF|ON}

Query Syntax :MEASureMHOLD?

Parameter	<Boolean>0	OFF
	<Boolean>1	ON
Return parameter	0	Turn the MAX hold function off.
	1	Turn the MAX hold function on.
Example	:MEASURE:MHOLD ON	
	:MEASURE:MHOLD?	
	->:MEASURE:MHOLD 1	

NUMeric Commands

:NUMeric	195
:NUMeric:FORMat	195
:NUMeric:NORMal.....	196
:NUMeric[:NORMal]:VALue	196
:NUMeric[:NORMal]:NUMber	198
:NUMeric[:NORMal]:ITEM<x>	198
:NUMeric[:NORMal]:PRESet	202
:NUMeric[:NORMal]:CLEar	204
:NUMeric[:NORMal]:DELeTe	205
:NUMeric[:NORMal]:HEADer	205
:NUMeric:LIST	206
:NUMeric:LIST:VALue	206
:NUMeric:LIST:NUMber	207
:NUMeric:LIST:ORDer.....	208
:NUMeric:LIST:SELEct.....	208
:NUMeric:LIST:ITEM<x>	209
:NUMeric:LIST:PRESet	209
:NUMeric:LIST:CLEar	211
:NUMeric:LIST:DELeTe	211
:NUMeric:HOLD	212

:NUMeric → Query

Description	Returns all numeric data output settings.
Query Syntax	:NUMeric?
Return parameter	<String>

Set →

:NUMeric:FORMat → Query

Description	Sets or returns the numeric data format.
Syntax	:NUMeric:FORMat {ASCii FLOat}
Query Syntax	:NUMeric:FORMat?

Parameter/	AScii	Select numeric data format to ascii.
Return parameter	FLOat	Select numeric data format to float.
Example	:NUMERIC:FORMAT ASCII :NUMERIC:FORMAT? ->:NUMERIC:FORMAT ASCII	



Note

- AScii
Physical values are output in the <NR3> format. (Only the elapsed integration time—TIME—is output in <NR1> format).
The data items are separated by commas.
- FLOat
A header (for example, “#240” or “#3208”) is added in front of each numeric data block.
A physical value in IEEE single-precision floating point (4-byte) format follows the header.
#N (N-digit byte number) (data byte sequence).
The byte order of the data of each item is MSB First.

:NUMeric:NORMAL



Description	Returns all normal numeric data output settings.
Query Syntax	:NUMeric:NORMAL?
Return parameter	<String>



Note

The number of numeric data items output by :NUMeric[:NORMAL]:ITEM<x> is determined by :NUMeric[:NORMAL]:NUMBER.

:NUMeric[:NORMAL]:VALue



Description	Returns the numeric data.
Query Syntax	:NUMeric[:NORMAL]:VALue? {<NRF>}

Parameter	<NRf> 1 to 200 (item number)
Example	<ul style="list-style-type: none"> If <NRf> is specified, only the numeric data for the specified item is output. :NUMERIC:NORMAL:VALUE? 1 -> 103.79E+00 If <NRf> is omitted, the numeric data items from 1 to the number specified by the : NUMERIC[:NORMAL]:NUMBER command are output in order. :NUMERIC:NORMAL:VALUE? -> 103.79E+00,1.0143E+00,105.27E+00,..(omitted)..,50.001E+00
Numeric Data Format	<ul style="list-style-type: none"> Measurement values U, I, P, PPPeak, PMPeak, S, Q, LAMBda, CFU, CFI, FU, FI, UTHD and ITHD Integrated values WH, WHP, WHM, AH, AHP and AHM. ASCII: <NR3> format. Example: [-]12.345E+00 Measurement values UPPeak, UMPeak, IPPeak and IMPeak. ASCII: <NR3> format. Example: [-]12.34E+00 Measurement values (PHI) ASCII: <NR3> = 0~9.9 format. Example: [-]9.9E+00 ASCII: <NR3> = 10~99.9 format. Example: [-]99.9E+00 ASCII: <NR3> = 100~999.9 format. Example: [-]999.9E+000 Elapsed integration time (TIME) ASCII: <NR1> format in units of seconds. Example: 3600 for 1 hour (1:00:00). <hr/> <ul style="list-style-type: none"> FLOAT: IEEE single-precision floating point (4-byte) format <hr/> <ul style="list-style-type: none"> No items (NONE) ASCII: NAN (Not A Number) FLOAT: 0x7E951BEE (9.91E+37)

Error Data	<ul style="list-style-type: none"> • Data does not exist (the display shows “-----”) <ul style="list-style-type: none"> ASCII: NAN (Not A Number) FLOAT: 0x7E951BEE (9.91E+37) • Data over (the display shows “-----“) <ul style="list-style-type: none"> ASCII: INF (INFinity) FLOAT: 0x7E94F56A (9.9E+37)
------------	---

Set →
 → Query

:NUMeric[:NORMal]:NUMBER

Description	Sets or returns the number of numeric data items that are transmitted by the :NUMeric[:NORMal]:VALue? command.
Syntax	:NUMeric[:NORMal]:NUMBER {<NRF> ALL}
Query Syntax	:NUMeric[:NORMal]:NUMBER?
Parameter/ Return parameter	<NRF> 1 to 200

Example

```
:NUMERIC:NORMAL:NUMBER 10
:NUMERIC:NORMAL:NUMBER
->:NUMERIC:NORMAL:NUMBER 10
```

 **Note**

- If the parameter is omitted from the :NUMeric[:NORMal]:VALue? command, the numeric data items from 1 to the specified value are output in order.
- By default, the number of numeric data items is set to 3.

Set →
 → Query

:NUMeric[:NORMal]:ITEM<x>

Description	Sets or returns the specified numeric data output item function.
Syntax	:NUMeric[:NORMal]:ITEM<x> {NONE <Function>[,<Element>][,Order]}
Query Syntax	:NUMeric[:NORMal]:ITEM<x>?

Parameter/ Return parameter	<x>	1 to 200
	NONE	No output item.
	<Function>	{U UPPeak UMPeak I IPPeak IMPeak P PPPeak PMPeak S Q LAMBda CFU CFI PHI FU FI UTHD ITHD EFFi WH WHP WHM AH AHP AHM TIME URANge IRANge MATH MCR URMS UMN UDC URMN UAC IRMS IMN IDC IRMN IAC UK IK PK LAMBDAK PHIK PHIUk PHIik UHDFk IHDFk PHDFk}
	<Element>	<NRf> SIGMa} (<NRf> = 1 to 3)
	<Order>	{TOTa DC <NRf>} (<NRf> = 1 to 50)

Example

```
:NUMERIC:NORMAL:ITEM1 U,1
:NUMERIC:NORMAL:ITEM1?
->:NUMERIC:NORMAL:ITEM1 U,1
:NUMERIC:NORMAL:ITEM1 UK,1,1
:NUMERIC:NORMAL:ITEM1?
->:NUMERIC:NORMAL:ITEM1 UK,1,1
```

- If <Order> is omitted, the order is set to TOTa.
- This instrument does not measure data for <Order> = DC.

<Function>	Function	GPM-8320-60/8330-60 Indicator
U	Voltage V	[V]
UPPeak	Maximum voltage: V+pk	[V+pk]
UMPeak	Minimum voltage: V-pk	[V-pk]
I	Current I	[I]
IPPeak	Maximum current: I+pk	[I+pk]
IMPeak	Minimum current: I-pk	[I-pk]
P	Active power P	[P]

PPPeak	Maximum power: P+pk	[P+pk]
PMPeak	Minimum power: P-pk	[P-pk]
S	Apparent power S	[VA]
Q	Reactive power Q	[VAR]
LAMBda	Power factor λ	[PF]
CFU	Voltage factor λ	[CFV]
CFI	Current factor λ	[CFI]
PHI	Phase difference Φ	[DEG]
FU	Voltage frequency fV	[VHz]
FI	Current frequency fI	[IHz]
UTHD	Total harmonic distortion of voltage Vthd	[THDV]
ITHD	Total harmonic distortion of current Ithd	[THDI]
EFFi	Power Efficiency	[EFFI]
WH	Watt hour WP	[WP]
WHP	Positive watt hour WP+	[WP+]
WHM	Positive watt hour WP-	[WP-]
AH	Ampere hour q	[q]
AHP	Positive ampere hour q+	[q+]
AHM	Positive ampere hour q	[q-]
TIME	Integration time	
URANge	Voltage range	
IRANge	Current range	
MATH	Mathematical Computation	[MATH]
MCR	Maximum Current Ratio	[MCR]
URMS	True rms voltage Vrms	
UMN	Rectified mean voltage calibrated to the rms value Vmn	[Vmn]

UDC	Simple voltage average V_{dc}	[Vdc]
URMN	Rectified mean voltage V_{rnm}	
UAC	AC voltage component V_{ac}	[Vac]
IRMS	True rms current I_{rms}	
IMN	Rectified mean current calibrated to the rms value I_{mn}	
IDC	Simple current average I_{dc}	[Idc]
IRMN	Rectified mean current I_{rnm}	
IAC	AC current component I_{ac}	[Iac]
UK	Rms voltage of harmonic order k $V(k)$	[V]
IK	Rms current of harmonic order k $I(k)$	[A]
PK	Active power of harmonic order k $P(k)$	[P]
LAMBDAK	Power factor of harmonic order k $\lambda(k)$	
PHIK	Phase difference between the voltage and current of harmonic order k $\phi(k)$	
PHIUk	Phase difference between harmonic voltage $V(k)$ and the fundamental wave $V(1)$ $\phi V(k)$	
PHIIk	Phase difference between harmonic current $I(k)$ and the fundamental wave $I(1)$ $\phi I(k)$	
UHDFk	Harmonic distortion factor of voltage $V_{hdf}(k)$	
IHDFk	Harmonic distortion factor of current $I_{hdf}(k)$	
PHDFk	Harmonic distortion factor of power $Phdf(k)$	

:NUMeric[:NORMal]:PRESet



Description	Presets the numeric data output item pattern.		
Syntax	:NUMeric[:NORMal]:PRESet {<NRf>}		
Parameter/ Return parameter	<NRf>	1 to 4	
Example	:NUMERIC:NORMAL:PRESET 1		
Patterns 1	ITEM<x>	<Function>	<Element>
	1	U	1
	2	I	1
	3	P	1
	4 ~ 6	U to P	2
	7 ~ 9	U to P	3
	10 ~ 12	U to P	SIGMA
	13 ~ 200	None	None
Patterns 2	ITEM<x>	<Function>	<Element>
	1	U	1
	2	I	1
	3	P	1
	4	S	1
	5	Q	1
	6	LAMBda	1
	7	PHI	1
	8	FU	1
	9	FI	1
	10 ~ 18	U to FI	2
	19 ~ 27	U to FI	3
	28 ~ 36	U to FI	SIGMA
	37 ~ 200	None	None

Patterns 3	ITEM<x>	<Function>	<Element>
	1	U	1
	2	I	1
	3	P	1
	4	S	1
	5	Q	1
	6	LAMBda	1
	7	PHI	1
	8	FU	1
	9	FI	1
	10	UPPeak	1
	11	UMPeak	1
	12	IPPeak	1
	13	IMPeak	1
	14	PPPeak	1
	15	PMPeak	1
	16 ~ 30	U to Peak	2
	31 ~ 45	U to Peak	3
	46 ~ 60	U to Peak	SIGMA
	61 ~ 200	None	None
Patterns 4	ITEM<x>	<Function>	<Element>
	1	U	1
	2	I	1
	3	P	1
	4	S	1
	5	Q	1
	6	LAMBda	1
	7	PHI	1
	8	FU	1

9	FI	1
10	UPPeak	1
11	UMPeak	1
12	IPPeak	1
13	IMPeak	1
14	TIME	1
15	WH	1
16	WHP	1
17	WHM	1
18	AH	1
19	AHP	1
20	AHM	1
21 ~ 40	U to AHM	2
41 ~ 60	U to AHM	3
61 ~ 80	U to AHM	SIGMA
81 ~ 200	None	None

:NUMERIC[:NORMAL]:CLEAR



Description Clears numeric data output items (sets the items to NONE).

Syntax :NUMERIC[:NORMAL]:CLEAR {ALL|<NRf>[,<NRf>]}

Parameter	ALL	Clear all items.
	1st <NRf>	1 to 200 (the number of the first item to clear)
	2nd <NRf>	1 to 200 (the number of the last item to clear)

Example :NUMERIC:NORMAL:CLEAR ALL



Note

If the 2nd <NRf> is omitted, the output item specified by the first and all following output items (up to number 200) are cleared.

:NUMeric[:NORMal]:DElete (Set) →

Description	Deletes numeric data output items.	
Syntax	:NUMeric[:NORMal]:DElete {<NRf>[,<NRf>]}	
Parameter	1st <NRf>	1 to 200 (the number of the first item to delete)
	2nd <NRf>	1 to 200 (the number of the last item to delete)
Example	:NUMERIC:NORMAL:DELETE 1 (Deletes ITEM1 and shifts ITEM2 and subsequent items forward). :NUMERIC:NORMAL:DELETE 1,3 (Deletes ITEM1 to ITEM3 and shifts ITEM4 and subsequent items forward).	



Note

- When output items are deleted, subsequent items shift forward to fill the empty positions. Empty positions at the end are set to NONE.
- If the second <NRf> is omitted, only the output item specified by the first number is deleted.

:NUMeric[:NORMal]:HEADer → (Query)

Description	Returns the numeric data header.	
Syntax	:NUMeric[:NORMal]:HEADer? {<NRf>}	
Parameter	<NRf>	1 to 200 (item number)
Example	<ul style="list-style-type: none"> • If <NRf> is specified, only the data name for the specified item number is output. :NUMERIC:NORMAL:HEADER? 1 -> U-E1 • If <NRf> is omitted, the data names of the items from 1 to the number specified by the : NUMeric[:NORMal]:NUMber command are output in order. 	

:NUMERIC:NORMAL:NUMBER 3

:NUMERIC:NORMAL:HEADER?

-> U-E1,I-E1,P-E1

:NUMeric:LIST

→ Query

Description Returns all harmonic measurement numeric list data output settings.

Query Syntax :NUMeric:LIST?

Return parameter <String>



Note

The number of numeric list data items output by :NUMeric:LIST:ITEM<x> is determined by :NUMeric:LIST:NUMBER.

:NUMeric:LIST:VALue

→ Query

Description Returns the harmonic measurement numeric list data.

Query Syntax :NUMeric:LIST:VALue? {<NRf>}

Parameter <NRf> 1 to 8 (item number)

Example

- if <NRf> is specified :NUMERIC:LIST:VALUE? 1
-> 103.58E+00,NAN,103.53E+00,0.09E+00,2.07E+00,0.04E+00,.. (omitted)..,0.01E+00,0.01E+00
(up to 52 data values)
- if <NRf> is omitted (when :NUMeric:LIST:NUMBER is set to 5)
:NUMERIC:LIST:VALUE?
-> 103.58E+00,NAN,103.53E+00,0.09E+00,2.07E+00,0.04E+00,.. (omitted)..,0.00E+00,0.00E+00
(up to 52*5 = 260 data values)
- When :NUMeric:FORMat is set to {FLOat}

:NUMERIC:LIST:VALUE?

-> #N (N-digit byte number)(data byte sequence)



Note

- A single numeric list data item consists of up to 52 items of numeric data in the following order: TOTal, DC, 1st harmonic, ..., :NUMeric:LIST:ORDer.
- If <Nrf> is specified, only the numeric list data of the specified item number is output (up to 52 items of data)
- If <Nrf> is omitted, the numeric list data of item numbers from 1 to :NUMeric:LIST:NUMber is output in order (up to 52 times the number specified by :NUMeric:LIST:ORDer)
- If harmonic set to OFF, block number is 1 ~ 10000
- If harmonic set to IEC or CSA, block number is 1 ~ 1000

:NUMeric:LIST:NUMBER

Set →

→ Query

Description	Sets or returns the number of numeric list data items that are transmitted by :NUMeric:LIST:VALue? command.	
Syntax	:NUMeric:LIST:NUMBER {<Nrf> ALL}	
Query Syntax	:NUMeric:LIST:NUMBER?	
Parameter/ Return parameter	<Nrf>	1 to 24 (ALL)
Example	:NUMERIC:LIST:NUMBER 3 :NUMERIC:LIST:NUMBER? ->:NUMERIC:LIST:NUMBER 3	



Note

- If the parameter is omitted from the `:NUMeric:LIST:VALue?` command, the numeric list data items from 1 to the specified value are output in order.
- By default, the number of numeric data items is set to 3.

`:NUMeric:LIST:ORDER`

Set →

→ Query

Description Sets or returns the maximum output harmonic order of the harmonic measurement numeric list data.

Syntax `:NUMeric:LIST:ORDER {<NRF>|ALL}`

Query Syntax `:NUMeric:LIST:ORDER?`

Parameter/ Return parameter `<NRF>` 1 to 50(ALL)

Example
`:NUMERIC:LIST:ORDER 10`
`:NUMERIC:LIST:ORDER?`
`->:NUMERIC:LIST:ORDER 10`

`:NUMeric:LIST:SElect`

Set →

→ Query

Description Sets or returns the output components of the harmonic measurement numeric list data.

Syntax `:NUMeric:LIST:SElect {EVEN|ODD|ALL}`

Query Syntax `:NUMeric:LIST:SElect?`

Parameter/ Return parameter `EVEN` Outputs the components of `TOTAL`, DC, and even-order harmonics.

`ODD` Outputs the components of `TOTAL`, DC, and odd-order harmonics .

`ALL` Outputs all components.

Example :NUMERIC:LIST:SELECT ALL
 :NUMERIC:LIST:SELECT?
 ->:NUMERIC:LIST:SELECT ALL

:NUMeric:LIST:ITEM<x>

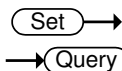

Description Sets or returns the output item (function and element) of the specified harmonic measurement numeric list data item.

Syntax :NUMeric:LIST:ITEM<x>
 {NONE|<Function>,<Element>}

Query Syntax :NUMeric:LIST:ITEM<x>?

Parameter/ Return parameter	<x>	1 to 24
	NONE	No output item.
	<Function>	{U P PHIU PHII UHDF IHDF PHDF}
	<Element>	1~3

Example :NUMERIC:LIST:ITEM1 U,1
 :NUMERIC:LIST:ITEM1?
 ->:NUMERIC:LIST:ITEM1 U,1

:NUMeric:LIST:PRESet



Description Presets the harmonic measurement numeric list data output item pattern.

Syntax :NUMeric:LIST:PRESet {<NRF>}

Parameter/ Return parameter	<NRF>	1 to 4
--------------------------------	-------	--------

Example :NUMERIC:LIST:PRESET 1

Patterns 1	ITEM<x>	<Function>	<Element>
	1	U	1

	2	I	1
	3	P	1
	4 ~ 6	U to P	2
	7 ~ 9	U to P	3
	10 ~ 24	None	None
Patterns 2	ITEM<x>	<Function>	<Element>
	1	U	1
	2	I	1
	3	P	1
	4	PHIU	1
	5	PHII	1
	6 ~ 10	U to PHII	2
	11 ~ 15	U to PHII	3
	16 ~ 24	None	None
Patterns 3	ITEM<x>	<Function>	<Element>
	1	U	1
	2	I	1
	3	P	1
	4	UHDF	1
	5	IHDF	1
	6	PHDF	1
	7 ~ 12	U to PHDF	2
	13 ~ 18	U to PHDH	3
	19 ~ 24	None	None
Patterns 4	ITEM<x>	<Function>	<Element>
	1	U	1
	2	I	1
	3	P	1

4	PHIU	1
5	PHII	1
6	UHDF	1
7	IHDF	1
8	PHDF	1
9 ~ 16	U to PHDF	2
17 ~ 24	U to PHDF	3

:NUMeric:LIST:CLEar



Description	Clears numeric data output items (sets the items to NONE).	
Syntax	:NUMeric:LIST:CLEar {ALL <NRf>[,<NRf>]}	
Parameter	ALL	Clear all items.
	1st <NRf>	1 to 24 (the number of the first item to clear)
	2nd <NRf>	1 to 24 (the number of the last item to clear)
Example	:NUMERIC:LIST:CLEAR ALL	
Note	If the 2nd <NRf> is omitted, the output item specified by the first and all following output items (up to number 8) are cleared.	

:NUMeric:LIST:DELeTe



Description	Deletes numeric data output items.	
Syntax	:NUMeric:LIST:DELeTe {<NRf>[,<NRf>]}	
Parameter	1st <NRf>	1 to 24 (the number of the first item to delete)
	2nd <NRf>	1 to 24 (the number of the last item to delete)

Example :NUMERIC:LIST:DELETE 1 (Deletes ITEM1 and shifts ITEM2 and subsequent items forward).
 :NUMERIC:LIST:DELETE 1,3 (Deletes ITEM1 to ITEM3 and shifts ITEM4 and subsequent items forward).



Note

- When output items are deleted, subsequent items shift forward to fill the empty positions. Empty positions at the end are set to NONE.
- If the second <NRF> is omitted, only the output item specified by the first number is deleted.

:NUMeric:HOLD

Set →

→ Query

Description Sets or returns the on/off (hold/release) status of the numeric data hold feature.

Syntax :NUMeric:HOLD {<Boolean>|OFF|ON}

Query Syntax :NUMeric:HOLD?

Parameter <Boolean>0 OFF
 <Boolean>1 ON

Return parameter 0 Turn the numeric hold function off.
 1 Turn the numeric hold function on.

Example :NUMERIC:HOLD ON
 :NUMERIC:HOLD?
 ->:NUMERIC:HOLD 1



Note

- If :NUMeric:HOLD is set to ON before :NUMeric[:NORMal]:VALue? or :NUMeric:LIST:VALue? is executed, all the numeric data at that point in time can be held internally.
- As long as :NUMeric:HOLD is set to ON, numeric data is held even when the numeric data on the screen is updated.
- If :NUMeric:HOLD is set to ON after having already

been set to ON before, the numeric data is cleared, and the most recent numeric data is held internally. When retrieving numeric data continuously, this method can be used to circumvent the need to repeatedly set :NUMeric:HOLD to OFF.

RATE Commands

:RATE	214
:RATE:AUTO	214
:RATE:AUTO:TIMEout	214
:RATE:AUTO:SYNChronize	215

:RATE



Description	Sets or returns the data update interval.	
Syntax	:RATE {<TIME> AUTO}	
Query Syntax	:RATE?	
Parameter/ Return parameter	<TIME>	100, 250, 500(ms), 1, 2, 5, 10, 20(s)
	AUTO	Select update rate at auto.
Example	:RATE 500MS	
	:RATE?	
	->:RATE 500.0E-03	

:RATE:AUTO 

Description	Returns all applicable settings for when the data update interval is set to Auto.	
Query Syntax	:RATE:AUTO?	
Return parameter	<String>	

:RATE:AUTO:TIMEout



Description	Sets or returns the timeout for when the data update interval is set to Auto.	
Syntax	:RATE:AUTO:TIMEout {<TIME>}	

Query Syntax	:RATE:AUTO:TIMEout?	
Parameter/ Return parameter	<TIME>	1, 5, 10, 20(s)
Example	RATE:AUTO:TIMEOUT 1 :RATE:AUTO:TIMEOUT? -> :RATE:AUTO:TIMEOUT 1	

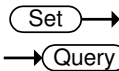

:RATE:AUTO:SYNChronize

Description	Sets or returns the synchronization source for when the data update interval is set to Auto.	
Syntax	:RATE:AUTO:SYNChronize {U<x> I<x> }	
Query Syntax	:RATE:AUTO:SYNChronize?	
Parameter/ Return parameter	U<x>	Select synchronize source at voltage. <x> = 1 to 3 (element)
	I<x>	Select synchronize source at current. <x> = 1 to 3 (element)
Example	:RATE:AUTO:SYNCHRONIZE U1 :RATE:AUTO:SYNCHRONIZE? -> :RATE:AUTO:SYNCHRONIZE U1	

RECall Commands

:RECall:NUMber	216
:RECall[:NORMal]:VALue	216
:RECall:LIST:VALue.....	217
:RECall:PANel	217

:RECall:NUMber

→ **Query**

Description Returns the number of blocks of measured data that is stored.

Query Syntax :RECall:NUMber?

Example :RECall:NUMber?
->100

:RECall[:NORMal]:VALue

→ **Query**

Description Returns the numeric data at the specified block number.

Query Syntax :RECall[:NORMal]:VALue? {<NRf>}

Parameter <NRf> 1 to 10000 (block number)

Example

- If <NRf> is specified, the numeric data at the specified block number will be returned.
- If you omit <NRf> or specify a number greater than the number of blocks that contain stored measured data (the number returned by :RECall:NUMber?), the entire returned numeric data will be “NAN” (no data).
- The output items and format are the same as those of “:NUMERIC[:NORMal]:VALue?” (when the item number is not specified).” To set the output items and format, use the NUMERIC group commands.

:RECall:LIST:VALue

→ Query

Description	Returns the numeric list data of harmonic measurement at the specified block number.
Query Syntax	:RECall:LIST:VALue? {<NRf>}
Parameter	<NRf> 1 to 1000 (block number)
Example	<ul style="list-style-type: none"> • If <NRf> is specified, the numeric list data at the specified block number will be returned. • If you omit <NRf> or specify a number greater than the number of blocks that contain stored measured data (the number returned by :RECall:NUMber?), the entire returned numeric data will be “NAN” (no data). • The output items and format are the same as those of “:NUMeric:LIST:VALue?” (when the item number is not specified).” To set the output items and format, use the NUMeric group commands.

:RECall:PANel

Set →

Description	Loads a setup parameter file.
Syntax	:RECall:PANel {<NRf>}
Parameter	<NRf> 1 to 4 (file number)
Example	:RECall:PANel 2

STATus Commands

:STATus.....	218
:STATus:CONDition	218
:STATus:EESE	218
:STATus:EESR	219
:STATus:ERRor.....	219
:STATus:FILTer<x>	220
:STATus:QENable.....	221
:STATus:QMESsage	221

:STATus → Query

Description Returns all the settings for the communication status feature.

Query Syntax :STATus?

Return parameter <String>

:STATus:CONDition → Query

Description Returns the contents of the condition register.

Query Syntax :STATus:CONDition?

Return parameter <NR1> 0 to 65535

Example :STATUS:CONDITION?
-> 8



Note

For information about the condition register, see Appendix, "Status system" at page 240.

:STATus:EESE Set → Query

Description Sets or returns the extended event enable register.

Syntax :STATus:EESE {<NRf>}

Query Syntax	:STATUS:EESE?
Parameter/ Return parameter	<NRF> 0 to 65535
Example	:STATUS:EESE 16 :STATUS:EESE? -> :STATUS:EESE 16



Note

For information about the condition register, see Appendix, "Status system" at page 240.

:STATUS:EESR → Query

Description	Returns the contents of the extended event register and clears the register.
Query Syntax	:STATUS:EESR?
Return parameter	<NR1> 0 to 65535
Example	:STATUS:EESR? -> 16



Note

For information about the condition register, see Appendix, "Status system" at page 240.

:STATUS:ERRor → Query

Description	Returns the error code and message of the last error that has occurred (top of the error queue).
Query Syntax	:STATUS:ERRor?
Return parameter	<String>
Example	:STATUS:ERROR? -> 113, "Underfined Header"



Note

- If no errors have occurred, 0, "No error" is returned.
- User can use the :STATus:QMESsage command to specify whether the message is included.
- Error message description:
 - Error_103: Invalid separator
 - Error_104: Data type error.
 - Error_108: Parameter not allowed.
 - Error_109: Missing parameter.
 - Error_113: Undefined header.
 - Error_131: Invalid suffix.
 - Error_141: Invalid character data.
 - Error_221: Setting conflict.
 - Error_222: Data out of range.
 - Error_813: Invalid operation.

:STATus:FILTer<x>

Set →

→ Query

Description	Sets or returns the transition filter.	
Syntax	:STATus:FILTer<x> {RISE FALL BOTH NEVer}	
Query Syntax	:STATus:FILTer<x>?	
Parameter/ Return parameter	<x>	1~16
	RISE	An event is set when the bit changes from 0 to 1.
	FALL	An event is set when the bit changes from 1 to 0.
	BOTH	An event is set when the bit changes either from 1 to 0 or form 0 to 1.
	NEVer	An event is never trigger.
Example	:STATus:FILTer2 RISE :STATus:FILTer2? -> :STATus:FILTer2 RISE	



Note

- Set how each bit in the condition register must change to trigger the setting of an event.
- For information about the condition register, see Appendix, "Status system" at page 240.

:STATus:QENable

Set →

→ Query

Description Sets or returns whether messages other than errors will be stored to the error queue (ON) or not (OFF).

Syntax :STATus:QENable {<Boolean>|OFF|ON}

Query Syntax :STATus:QENable?

Parameter <Boolean>0 OFF
<Boolean>1 ON

Return parameter 0 Function is off.
1 Function is on.

Example :STATus:QENABLE ON
:STATus:QENABLE?
-> :STATus:QENABLE 1

:STATus:QMESsage

Set →

→ Query

Description Sets or returns whether message information will be attached to the response to the STATus:ERROR? query (ON/OFF).

Syntax :STATus:QMESsage {<Boolean>|OFF|ON}

Query Syntax :STATus:QMESsage?

Parameter <Boolean>0 OFF
<Boolean>1 ON

Return parameter 0 Function is off.
1 Function is on.

Example :STATUS:QMMESSAGE ON
 :STATUS:QMMESSAGE?
 -> :STATUS:QMMESSAGE 1

STORe Commands

:STORe	223
:STORe[:STATe].....	223
:STORe:INTerval	223
:STORe:PANel.....	224

:STORe → Query

Description Returns all storage settings.

Syntax :STORe?

Return parameter <String>

Set →

:STORe[:STATe] → Query

Description Sets or returns the storage on/off state.

Syntax :STORe[:STATe] {<Boolean>|OFF|ON}

Query Syntax :STORe[:STATe]?

Parameter <Boolean>0 OFF
<Boolean>1 ON

Return parameter 0 Storage function is off.
1 Storage function is on.

Example :STORe:STATE ON
:STORe:STATE?
->:STORe:STATE 1

Set →

:STORe:INTerval → Query

Description Sets or returns the storage interval.

Syntax :STORe:INTerval {<NRf>,<NRf>,<NRf>}

Query Syntax :STORe:INTerval?

Parameter/	1st <NRf>	0 to 99 (hours)
Return parameter	2nd <NRf>	0 to 59 (minutes)
	3rd <NRf>	0 to 59 (seconds)
Example	:STORE:INTERVAL 0,0,1 :STORE:INTERVAL? ->:STORE:INTERVAL 0,0,1	



Note

• When time interval is set 00:00:00, the storage interval is identical with the designated data update interval.

:STORe:PANel



Description	Saves setup parameters to a file.	
Syntax	:STORe:PANel {<NRf>}	
Parameter	<NRf>	1 to 4 (file number)
Example	:STORe:PANel 1	

SYSTEM Commands

:SYSTEM.....	225
:SYSTEM:BRIGHtness	225
:SYSTEM:COMMUnicate:COMMAnd	226
:SYSTEM:COMMUnicate:ETHernet:MACAddress	226
:SYSTEM:FIRMware:DATE.....	226
:SYSTEM:KEY:BEEPer	227
:SYSTEM:KLOCK	227
:SYSTEM:MODEL.....	228
:SYSTEM:RESolution.....	228
:SYSTEM:SERial	228
:SYSTEM:VERsion[:FIRMware]	228

:SYSTEM → Query

Description Returns all system settings.

Query Syntax :SYSTEM?

Return parameter <String>

Set →

:SYSTEM:BRIGHtness → Query

Description Sets or returns the brightness level.

Syntax :SYSTEM:BRIGHtness {<NRF>}

Query Syntax :SYSTEM:BRIGHtness?

Parameter/ Return parameter <NRF> 1~10

Example :SYSTEM:BRIGHtness 7
 :SYSTEM:BRIGHtness?
 ->:SYSTEM:BRIGHtness 7

		(Set) →
:SYSTem:COMMunicate:COMMand		→ (Query)
Description	Sets or returns the command type.	
Syntax	:SYSTem:COMMunicate:COMMand {DEFAULT USER}	
Query Syntax	:SYSTem:COMMunicate:COMMand?	
Parameter/	DEFAULT	GPM8320-60/8330-60.
Return parameter	USER	User-define.
Example	:SYSTEM:COMMUNICATE:COMMAND DEFAULT :SYSTEM:COMMUNICATE:COMMAND? ->:SYSTEM:COMMUNICATE:COMMAND DEFAULT	
 Note	<ul style="list-style-type: none"> The SCPI mode is used to determine whether the *IDN? query returns the “Default” or “User” identification string. 	

:SYSTem:COMMunicate:ETHernet:MACadd		→ (Query)
Description	Returns the Ethernet MAC address.	
Query Syntax	:SYSTem:COMMunicate:ETHernet:MACaddress?	
Example	:SYSTEM:COMMUNICATE:ETHERNET:MACADDRESS? - >:SYSTEM:COMMUNICATE:ETHERNET:MACADDRE SS 00:22:24:00:00:00	

:SYSTem:FIRMware:DATE		→ (Query)
Description	Returns the firmware date.	
Query Syntax	:SYSTem:FIRMware:DATE?	
Return parameter	<Date>	yyyymmdd

Example :SYSyEM:FIRMyWARE:DATE?
 ->:SYSyEM:FIRMyWARE:DATE 20200101

:SYSTEm:KEY:BEEPer



Description	Sets or returns the keyclick beeper state.	
Syntax	:SYSTEm:KEY:BEEPer {<Boolean> OFF ON}	
Query Syntax	:SYSTEm:KEY:BEEPer?	
Parameter	<Boolean> 0	OFF
	<Boolean> 1	ON
Return parameter	0	Turn the keyclick beeper function off.
	1	Turn the keyclick beeper function on.
Example	:SYSTEM:KEY:BEEPER OFF :SYSTEM:KEY:BEEPER? ->:SYSTEM:KEY:BEEPER 0	

:SYSTEm:KLOCK



Description	Sets or returns the on/off state of the key protection.	
Syntax	:SYSTEm:KLOCK {<Boolean> OFF ON}	
Query Syntax	:SYSTEm:KLOCK?	
Parameter	<Boolean> 0	OFF
	<Boolean> 1	ON
Return parameter	0	Turn the key protection function off.
	1	Turn the key protection function on.
Example	:SYSTEM:KLOCK OFF :SYSTEM:KLOCK? ->:SYSTEM:KLOCK 0	

:SYSTem:MODEL → Query

Description	Returns the model code.
Syntax	:SYSTem:MODEL?
Example	:SYSTEM:MODEL? ->:SYSTEM:MODEL "GPM-8320-60/8330-60"

:SYSTem:RESolution → Query

Description	Returns the numeric data display resolution.
Query Syntax	:SYSTem:RESolution?
Example	:SYSTEM:RESOLUTION? ->:SYSTEM:RESOLUTION 5

:SYSTem:SERial → Query

Description	Returns the serial number.
Syntax	:SYSTem:SERial?
Example	:SYSTEM:SERIAL? ->:SYSTER:SERIAL 123456789A

:SYSTem:VERsion[:FIRMware] → Query

Description	Returns the firmware version.
Query Syntax	:SYSTem:VERsion[:FIRMware]?
Example	:SYSTEM:VERSION:FIRMWARE? ->"V1.00"



Note

Returns the Ver. item string of the system Information menu.

APPENDIX

Specifications	230
General Specifications	230
Input	231
Voltage and Current Accuracy	232
Active Power Accuracy	233
Voltage, Current and Active Power Measurements ..	234
Frequency Measurement.....	236
Integration.....	237
Harmonic Measurement.....	237
D/A Output (Options)	238
Remote Control Input/Output Signal (Options)	239
Status system	240
Dimensions	244
Certificate Of Compliance.....	245
Power measurement.....	246
Measurement for small current	246
Measurement for large current	247
Measurement Function	247
Wiring diagram.....	248

Specifications

Below are the basic conditions required to operate the GPM-8320-60/8330-60 within specification:

- Calibration: Yearly
- Operating Environment: 18 °C to 28 °C (64.4 °F to 82.4 °F)
- Humidity: < 80% RH,
- Accuracy: \pm (% of reading + % of range)
- The specifications apply when it warmed up for at least 30 minutes and operates in the slow rate.
- The power supply cable must be grounded to ensure accuracy.
- Input voltage and current must be standard sine wave.
- The power factor must be 1.
- The crest factor must be 3.
- The common-mode voltage must be zero.

General Specifications

Specification Conditions:

Temperature: 23 °C \pm 5 °C

Humidity: < 80% RH (non-condensing)

Operating Environment: (0 °C to 40 °C)

Temperature Range:

30 °C to 40 °C, Relative Humidity: < 70% RH (non-condensing);

> 40 °C, Relative Humidity: < 50% RH (non-condensing)

Indoor use only

Altitude: <2000 meters

Pollution degree 2

Storage Conditions (-40 °C to 70 °C)

Humidity: < 90% RH (non-condensing)

General:

Power Source: 100 V to 240 V AC 50 Hz / 60 Hz

Power Consumption: Max 35 VA

Bench Dimensions: 220 mm (W) X 132 mm (H) X 402.5 mm (D) (w/t bumpers)

Weight: Approximately 3.85 kg

Input

Item	Specifications	
Input type	Voltage	Floating input through resistive voltage divider
	Current	Floating input through shunt
Measure range	Voltage	15 V, 30 V, 60 V, 150 V, 300 V, 600 V and 1000 V
	Current	
	Direct input	1 A, 2 A, 5 A, 10 A, 20 A and 60 A
	Sensor input	EX1: 2.5 V, 5 V and 10 V EX2: 50 mV, 100 mV, 200 mV, 500 mV, 1 V and 2 V
Input impedance	Voltage	Input resistance: approach 2 MΩ
	Current	
	Direct input range	Input resistance: approach 1.65 mΩ 1 A ~ 60 A
	Sensor input	
	Input range 2.5 V ~ 10 V (EX1)	Input resistance: approach 100 kΩ
Input range 50 mV ~ 2 V (EX2)	Input resistance: approach 20 kΩ	
Continuous maximum allowable input	Voltage	Peak value of 1.5 kV or RMS value of 1 kV, whichever is less When Range 1000 V CF=1.5
	Current	
	Direct input range 1 A ~ 60 A	Peak value of 150 A or RMS value of 70 A, whichever is less Guaranteed specifications 65 A
Sensor input	Peak value is less than or equal to 5 times of the rated range	
Input bandwidth	DC, 0.1 Hz ~ 100 kHz	
Continuous maximum Common-mode voltage	600 V _{rms} , CAT II	
Line filter	Select OFF or ON (cut off frequency of 500 Hz)	
Frequency filter	Select OFF or ON (cut off frequency of 500 Hz)	
A/D converter	Simultaneous conversion voltage and current inputs	
	Resolution	16bits
	Maximum conversion rate	Approx. 300 kHz

When the data update interval is 100 ms the numeric display 10 items display update interval is 200 ms.

When the data update interval is 100 ms or 250 ms and the numeric value display is set to Matrix or ALL Items display update interval is 500 ms.

The waveform display update intervals are approximately 1 s.

Voltage and Current Accuracy

Item	Specifications
Requirements	Temperature 23 °C ± 5 °C
	Humidity 30% to 75% RH
	Input waveform Sine wave crest factor = 3
	common-mode voltage 0 V
	Number of displayed digits 5 digits
Accuracy	Frequency filter Turn on to measure voltage or current of 200 Hz or less
	After 30 minutes after warm-up time has passed
	After measurement range is changed (zero-level compensation)
	Update interval is 250 ms
	Effective range 1% to 105% of range
	DC ± (0.2% of reading + 0.2% of range)
	0.1 Hz ≤ f < 45 Hz ± (0.1% of reading + 0.2% of range)
	45 Hz ≤ f ≤ 66 Hz ± (0.1% of reading + 0.05% of range)
	66 Hz < f ≤ 1 kHz ± (0.1% of reading + 0.2% of range)
	1 kHz < f ≤ 10 kHz ± ((0.07 × f)% of reading + 0.3% of range) ~ Voltage
± ((0.13 × f)% of reading + 0.4% of range) ~ Current	
± ((0.07 × f)% of reading + 0.3% of range) ~ Ext 1/2	
10 kHz < f ≤ 100 kHz ± (0.5% of reading + 0.5% of range) ± [(0.04 × (f-10))% of reading] ~ Voltage	
± ((0.13 × f)% of reading + 0.5% of range) ~ Current	
± (0.5% of reading + 0.5% of range) ± [(0.04 × (f-10))% of reading] ~ Ext 1/2	
Values for voltage in excess of 750 V for which 30 kHz < f ≤ 100 kHz are reference only.	
Values for current in excess of 20 A for which 30 kHz < f ≤ 100 kHz are reference only.	

Temperature coefficient	Add	$\pm 0.03\%$ of reading/ $^{\circ}\text{C}$ within the range 5°C to 18°C or 28°C to 40°C .
When the line filter is turned ON	45 Hz to 66 Hz < 45 Hz	Add 0.3% of reading Add 1% of reading
Accuracy when the crest factor is set to 6 or 6A	Accuracy obtained by doubling the measurement range error for the accuracy when the crest factor is set to 3	
Accuracy changes caused by data update interval	When the data update interval is 100 ms, and Auto, add 0.05% of reading to the 0.1 Hz to 1 kHz accuracy.	
Influence of temperature changes after zero-level compensation or range change	Add 0.02% of range/ $^{\circ}\text{C}$ to the DC voltage accuracy. Add the following value to the DC current accuracies. 1 A/2 A/5 A/10 A/20 A/60 A ranges 500 $\mu\text{A}/^{\circ}\text{C}$ External current sensor input (/EX1) 1 $\text{mV}/^{\circ}\text{C}$ External current sensor input (/EX2) 50 $\mu\text{V}/^{\circ}\text{C}$	
Accuracy when the crest factor is set to 6 or 6A	accuracy obtained by doubling the measurement range error for the accuracy when the crest factor is set to 3	
Accuracy changes caused by data update interval	When the data update interval is 100 ms, and Auto, add 0.05% of reading to the 0.1 Hz to 1 kHz accuracy.	

Active Power Accuracy

Item	Specifications
Requirements	same as the conditions for voltage and current. Power factor 1
Accuracy	Effective range 1% to 110% of range
	DC $\pm (0.3\% \text{ of reading} + 0.2\% \text{ of range})$
	$0.1\text{Hz} \leq f < 45 \text{ Hz}$ $\pm (0.3\% \text{ of reading} + 0.2\% \text{ of range})$
	$45 \text{ Hz} \leq f \leq 66 \text{ Hz}$ $\pm (0.1\% \text{ of reading} + 0.05\% \text{ of range})$
	$66 \text{ Hz} < f \leq 1\text{kHz}$ $\pm (0.2\% \text{ of reading} + 0.2\% \text{ of range})$
	$1 \text{ kHz} < f \leq 10 \text{ kHz}$ $\pm (0.3\% \text{ of reading} + 0.5\% \text{ of range}) \pm$ $[\{0.13 \times f\}\% \text{ of reading}]$
	$10 \text{ kHz} < f \leq 100 \text{ kHz}$ $\pm (0.5\% \text{ of reading} + 1\% \text{ of range}) \pm$ $[\{0.13 \times f\}\% \text{ of reading}]$
Influence of power factor	when power factor (λ) = 0 (S: apparent power) $\pm 0.1\%$ of S for $45 \text{ Hz} \leq f \leq 66 \text{ Hz}$ $\pm \{(0.1 + 0.15 \times f)\%$ of S} for up to 100 kHz as reference data * f is frequency of input signal in kHz when $0 < \lambda < 1$ (Φ : phase angle of the Voltage and current)

	$(\text{power reading}) \times [(\text{power reading error}\%) + (\text{power range}\%) \times (\text{power range} / \text{indicated apparent power value}) + \{\tan\Phi \times (\text{influence when } \lambda=0)\%\}]$	
When the line filter is turned ON	45 Hz to 66 Hz	Add 0.3% of reading
	< 45 Hz	Add 1% of reading
Temperature coefficient	same as the temperature coefficient for voltage and current	
Accuracy when the crest factor is set to 6 or 6A	accuracy obtained by doubling the measurement range error for the accuracy when the crest factor is set to 3	
Accuracy of apparent power S	voltage accuracy + current accuracy	
Accuracy of reactive power Q	$\text{accuracy of apparent power} + (\sqrt{1.0004 - \lambda^2}) - (\sqrt{1 - \lambda^2}) \times 100\%$	
Accuracy of power factor λ	$\pm [(\lambda - \lambda / 1.0002) + \cos\theta - \cos\{\theta + \sin^{-1}(\text{influence from the power factor when } \lambda = 0\%/100)\}] \pm 1$ digit when voltage and current are at the measurement range rated input	
Accuracy of phase difference Φ	$\pm [\theta - \cos^{-1}(\lambda / 1.0002) + \sin^{-1}(\text{influence from the power factor when } \lambda = 0\% / 100)] \pm 1$ digit when voltage and current are at the measurement range rated input	
Accuracy when the crest factor is set to 6 or 6A	accuracy obtained by doubling the measurement range error for the accuracy when the crest factor is set to 3	
Accuracy changes caused by data update interval	When the data update interval is 100 ms, and Auto, add 0.05% of reading to the 0.1 Hz to 1 kHz accuracy.	

Voltage, Current and Active Power Measurements

Item	Specifications
Measurement method	Digital sampling method
Crest factor	3 or 6 (6A)
Wiring system	1P3W, 3P3W, 3P4W, 3V3A
Range select	Select manual or auto ranging
	Auto-range increase
	The range is upped when any of the following conditions is met.
Auto range	Crest factor 3 Vrms or Irms exceeds 130% of the currently set measurement range. Vpk, Ipk value of the input signal exceeds 300% of the currently set measurement range.

	<p>Crest factor 6 Vrms or Irms exceeds 130% of the currently set measurement range. Vpk, Ipk value of the input signal exceeds 600% of the currently set measurement range.</p> <p>Crest factor 6A Vrms or Irms exceeds 260% of the currently set measurement range. Vpk, Ipk value of the input signal exceeds 600% of the currently set measurement range.</p>
	<p>Auto-range decline The range is downed when all of the following conditions are met.</p> <p>Crest factor 3 Vrms or Irms is less than or equal to 30% of the measurement range. Vrms or Irms is less than or equal to 125% of the next lower measurement range. Vpk, Ipk value of the input signal exceeds 300% of the currently set measurement range.</p> <p>Crest factor 6 or 6A Vrms or Irms is less than or equal to 30% of the measurement range. Vrms or Irms is less than or equal to 125% of the next lower measurement range. Vpk, Ipk value of the input signal exceeds 600% of the currently set measurement range.</p>
Display mode	AC+DC (the true RMS value of voltage and current)
Switching	V-MEAN (the rectified mean value calibrated to the RMS value of the voltage and the true RMS value of the current)
	AC
	DC
Measurement synchronization	Select voltage, current, or off
source	In the case of Auto Update Rate, select the voltage or current from the equipped element.
Line filter	Select OFF or ON (cutoff frequency at 500 Hz).
Peak measurement	Measures the peak (max, min) value of voltage, current or power from the instantaneous voltage, instantaneous current or instantaneous power that is sampled.
Zero-level compensation	Removes the internal offset of the measure unit (After measurement range is changed)

Measurement parameters	Voltage	Vrms , Vmn, Vdc , Vac
	Current	Irms , Idc , Iac
	Active Power	P
	Apparent Power	VA
	Reactive power	VAR
	Power Factor	PF
	Crest Factor	CFI,CFV
	Phase Angle	DEG
	Frequency	1Hz and VHz
	Voltage Peak	V+pk and V-pk
	Current Peak	I+pk and I-pk
	Active Power Peak	P+pk and P-pk
	Total Harmonic Distortion	THDI and THDV
	Mathematical Computation	MATH, EFFi
	Maximum Current Ratio	MCR

Frequency Measurement

Item	Specifications	
Measurement item	Voltage and current	
Measurement frequency range	Data update interval	Measurement Frequency Range
	0.1 s	$20 \text{ Hz} \leq f \leq 100 \text{ kHz}$
	0.25 s	$10 \text{ Hz} \leq f \leq 100 \text{ kHz}$
	0.5 s	$5.0 \text{ Hz} \leq f \leq 100 \text{ kHz}$
	1 s	$2.0 \text{ Hz} \leq f \leq 100 \text{ kHz}$
	2 s	$1.0 \text{ Hz} \leq f \leq 100 \text{ kHz}$
	5 s	$0.5 \text{ Hz} \leq f \leq 100 \text{ kHz}$
	10 s	$0.2 \text{ Hz} \leq f \leq 100 \text{ kHz}$
	20 s	$0.1 \text{ Hz} \leq f \leq 100 \text{ kHz}$
	Auto (*)	$0.1 \text{ Hz} \leq f \leq 100 \text{ kHz}$
	(*) Limit of the measurement lower limit frequency by the Timeout setting	
	Timeout	lower limit frequency
	1 s	2.0 Hz
	5 s	0.5 Hz
	10 s	0.2 Hz
20 s	0.1 Hz	
Measurement range	Auto switching among six types: 100 mHz, 1 Hz, 10 Hz, 100 Hz, 1 kHz, 10 kHz, and 100 kHz.	
Frequency filter	Select OFF or ON (cut off frequency of 500 Hz)	

Accuracy	<p>Requirements When the input signal level is 30% or more of the measurement range If the crest factor is set to 3. (60% or more if the crest factor is set to 6 or 6A)</p> <ul style="list-style-type: none"> • Frequency filter is ON when measuring voltage or current of 200 Hz or less. <p>± (0.06% of reading)</p>
----------	--

Integration

Item	Specifications
Mode	Select manual integration mode, standard integration mode, or repetitive integration mode.
Timer	Automatically stop integration by setting a timer. Selectable range: 0 hours 00 minutes 00 seconds to 9999 hours 59 minutes 59 seconds
Count overflow	WP: 999999 MWh/-99999 MWh q: 999999 MAh/-99999 MAh
Accuracy	±(Power accuracy (or current accuracy) + 0.1% of reading) (fixed range)
Range setting	Auto range or fixed range is available for Integration
Timer accuracy	±0.02%
Remote control	Start, stop and reset operations are available using an external remote signal. (option)

Harmonic Measurement

Item	Specifications			
Measured item	Voltage, Current, Power			
Measured method	Zero-cross simultaneous calculation method			
Frequency range	10 Hz to 1.2 kHz.			
FFT data length	4096			
Sample rate, window width, and upper limit of Analysis orders	Fundamental Frequency	Sample rate	Window Width	upper limit of Analysis orders
	45 Hz to 55 Hz	f x 512	10	50
	54 Hz to 66 Hz	f x 512	12	50
Sample rate, window width, and upper limit of Analysis orders	Fundamental Frequency	Sample rate	Window Width	upper limit of Analysis orders
	10 Hz to 67 Hz	f x 1024	1	50
	67 Hz to 150 Hz	f x 512	2	32
	150 Hz to 300 Hz	f x 256	4	16
	300 Hz to 600 Hz	f x 128	8	8
	600 Hz to 1200 Hz	f x 64	16	4

	Frequency	Voltage	Current	Power
Accuracy	10 Hz ≤ f < 45 Hz	0.15% of reading	0.15% of reading	0.35% of reading
		+ 0.35% of range	+ 0.35% of range	+ 0.50% of range
	45 Hz ≤ f < 440 Hz	0.15% of reading	0.15% of reading	0.25% of reading
		+ 0.35% of range	+ 0.35% of range	+ 0.50% of range
	440 Hz ≤ f < 1.2kHz	0.20% of reading	0.20% of reading	0.40% of reading
		+ 0.35% of range	+ 0.35% of range	+ 0.50% of range

* 50 Hz/60 Hz Compliant IEC61000-4-7 (Update Rate must be ≥ 0.5 s).

* Harmonic calculation: FFT method in which FFT data length is divided into 2 types: 1024 and 4096.

* FFT data length automatically switches in accord with the Frequency and Update Rate of measured signal.

D/A Output (Options)

Item	Specifications
Output voltage	±5 V FS (approach ±7.5 V maximum) against each rated value.
Number of output channels	12
Output items	Set for each channel : V, I, P, VA, VAR, PF, DEG, VHZ, IHZ, Vpk, Ipk, WP, WP±, q, q±, OFF
Accuracy	±(accuracy of each measurement item + 0.2% of FS) (FS = 5 V)
D/A conversion resolution	16 bits
Minimum load	100 kΩ
Update Interval	Same as the data update interval. In the case of Auto Update Rate, update interval is equal to signal interval. More than 100 ms.
Temperature coefficient	±0.05%/°C of FS

Remote Control Input/Output Signal (Options)

Item	Specifications
Remote control input signal	EXT HOLD, EXT TRIG, EXT START, EXT STOP, EXT RESET
Remote control output signal	INTEG BUSY
I/O level	TTL
I/O logic format	Negative logic, Falling edge

*Q (VAR), S (VA), λ (PF) and Φ (DEG) are originated from the measured values including voltage, current and active power which go through computation process. In respect to distorted signal input, accordingly, the value acquired from other instruments, which employ different methods, may differ from that acquired from GPM-8320-60/8330-60 unit.

* "Zero" will be shown for S or Q and "--" will be displayed for λ and Φ when either current or voltage is less than 0.5% of the rated range (less than or equivalent to 1% when crest factor is set 6 or 6A).

Status system

The diagram below is a description of the status system

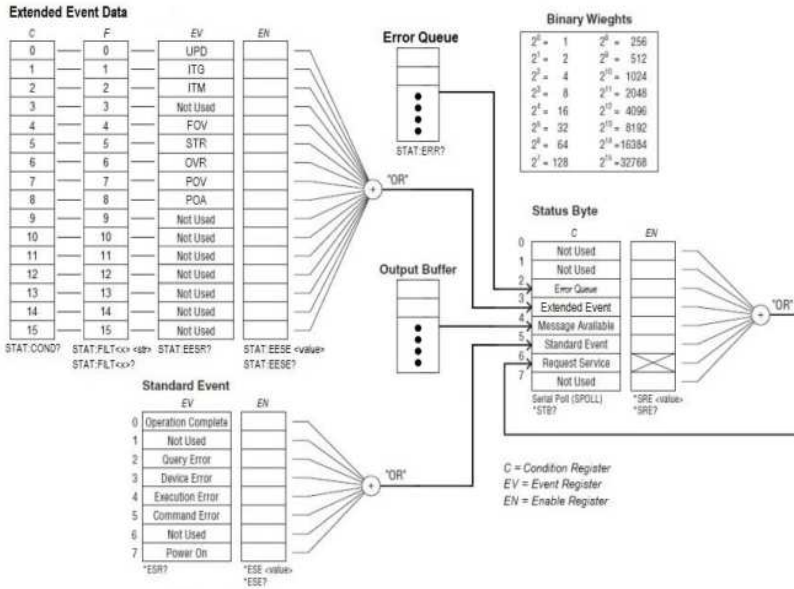

The extended event register receives information about changes in the condition register, which indicates the instrument's internal condition. The information is the result of edge detection performed by the transition filter.

The following table lists the bit definitions for the condition register:

Bit	Name	Decimal	Definition
0	Updating	1	The measured data is being updated. UPD changing from 1 to 0 indicates that updating has been completed.
1	Integrate Busy	2	During integration.
2	Integrate Time Busy	4	The integration timer is operating.
3	Not Used	8	(Reserved for future use)
4	Frequency Over	16	The frequency is outside the measurement range.
5	Store Busy	32	During storage.
6	Measured Data Over	64	The voltage or current exceeds its range.
7	Voltage Peak Over	128	A peak over-range is detected in the voltage.
8	Current Peak Over	256	A peak over-range is detected in the current.
9	Not Used	512	(Reserved for future use)
10	Not Used	1024	(Reserved for future use)
11	Not Used	2048	(Reserved for future use)
12	Not Used	4096	(Reserved for future use)
13	Not Used	8192	(Reserved for future use)
14	Not Used	16384	(Reserved for future use)
15	Not Used	32768	(Reserved for future use)

The transition filter parameters detect changes in the specified condition register bits (numeric suffixes 1 to 16) and overwrite the extended event register in the following ways.

Condition	Definition
RISE	The specified extended event register bit is set to 1 when the corresponding condition register bit changes from 0 to 1.
FALL	The specified extended event register bit is set to 1 when the corresponding condition register bit changes from 1 to 0.
BOTH	The specified extended event register bit is set to 1 when the corresponding condition register bit changes from 0 to 1 or from 1 to 0.
NEVer	Always zero.

The following table describes the Standard Event Register

Bit	Name	Decimal	Definition
0	Operation Complete	1	All commands prior to and including *OPC have been executed.
1	Not Used	2	(Reserved for future use)
2	Query Error	4	The instrument tried to read the output buffer but it was empty. Or, a new command line was received before a previous query has been read. Or, both the input and output buffers are full.
3	Device Error	8	A device error, including a self-test error or calibration error, occurred (an error in the -300 range or any positive error has been generated).
4	Execution Error	16	An execution error occurred (an error in the -200 range has been generated).
5	Command Error	32	A command syntax error occurred (an error in the -100 range has been generated).
6	Not Used	64	(Reserved for future use)
7	Power On	128	Power has been cycled since the last time the event register was read or cleared.

The following table describes the Status Byte Register.

Bit	Name	Decimal	Definition
0	Not Used	1	(Reserved for future use)
1	Not Used	2	(Reserved for future use)
2	Error Queue	4	One or more errors have been stored in the Error Queue. Use STAT:ERR? to read and delete errors.
3	Extended Event	8	One or more bits are set in the Extended Event Register (bits must be enabled, see STAT:EESE).
4	Message Available	16	Data is available in the instrument's output buffer.
5	Standard Event	32	One or more bits are set in the Standard Event Register (bits must be enabled, see *ESE).
6	Request Service	64	One or more bits are set in the Status Byte Register and may generate a Request for Service (RQS). Bits must be enabled using *SRE.
7	Not Used	128	(Reserved for future use)

Dimensions

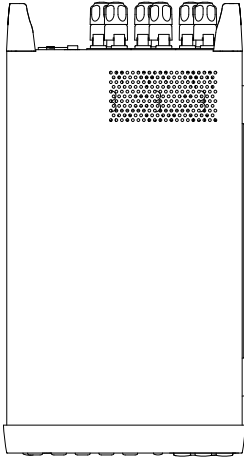

Unit = mm

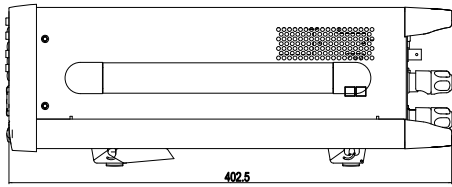
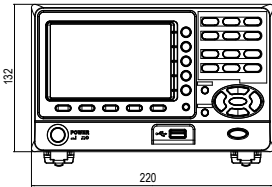

Certificate Of Compliance

We

GOOD WILL INSTRUMENT CO., LTD.

declare that the CE marking mentioned product

satisfies all the technical relations application to the product within the scope of council:

Directive: EMC; LVD; WEEE; RoHS

The product is in conformity with the following standards or other normative documents:

© EMC	
EN 61326-1	Electrical equipment for measurement, control and laboratory use -- EMC requirements
Conducted & Radiated Emission EN 55011 / EN 55032	Electrical Fast Transients EN 61000-4-4
Current Harmonics EN 61000-3-2 / EN 61000-3-12	Surge Immunity EN 61000-4-5
Voltage Fluctuations EN 61000-3-3 / EN 61000-3-11	Conducted Susceptibility EN 61000-4-6
Electrostatic Discharge EN 61000-4-2	Power Frequency Magnetic Field EN 61000-4-8
Radiated Immunity EN 61000-4-3	Voltage Dip/ Interruption EN 61000-4-11 / EN 61000-4-34
© Safety	
EN 61010-1 :	Safety requirements for electrical equipment for measurement, control, and laboratory use - Part 1: General requirements

GOODWILL INSTRUMENT CO., LTD.

No. 7-1, Jhongsing Road, Tucheng District, New Taipei City 236, Taiwan

Tel: +886-2-2268-0389

Fax: +886-2-2268-0639

Web: <http://www.gwinstek.com>

Email: marketing@goodwill.com.tw

GOODWILL INSTRUMENT (SUZHOU) CO., LTD.

No. 521, Zhujiang Road, Snd, Suzhou Jiangsu 215011, China

Tel: +86-512-6661-7177

Fax: +86-512-6661-7277

Web: <http://www.instek.com.cn>

Email: marketing@instek.com.cn

GOODWILL INSTRUMENT EURO B.V.

De Run 5427A, 5504DG Veldhoven, The Netherlands

Tel: +31-(0)40-2557790

Fax: +31-(0)40-2541194

Email: sales@gw-instek.eu

Power measurement

- Method
- Direct read method: Directly read the measurement value measured from power measuring instrument.
 - The average power method: Record the actual power value within a settable period of time and then take the average. A settable period of time isn't less than 10min. The maximum measurement interval is one second.
 - Energy accumulation method: Measure the energy within a settable period of time and then divide it by the time to get the power. A settable period of time isn't less than 10min. The cumulative energy must be greater than the resolution by 200 times.
-

Measurement for small current

Voltage measurement mode measured from power supply side (Connect to ammeter internally). The current measurement is accurate. The voltage measurement on load could be larger than the actual one due to partial pressure of multi-measurement ammeter.

Connection

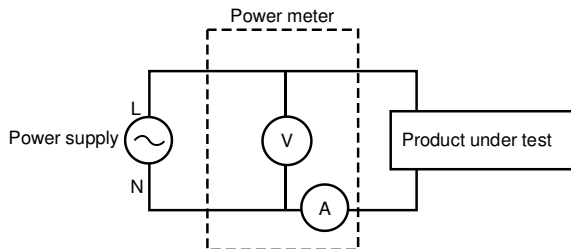

$$\text{Power loss} = (\text{Input current}[A])^2 \times 505\text{m}\Omega$$

Measurement for large current

Voltage measurement mode measured from load side (Connect to ammeter externally).

The voltage measurement is accurate. The current measurement on load could be larger than the actual one due to leakage current of multi-measurement voltage.

Connection

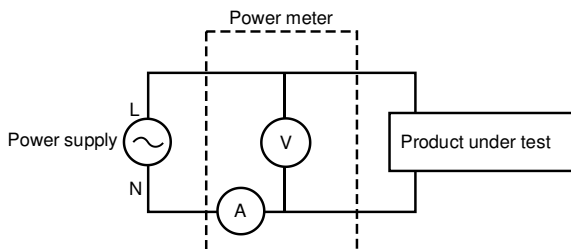

$$\text{Power loss} = (\text{Input voltage}[V])^2 / 2M\Omega$$

Measurement Function

	Wiring mode	Single-phase, three-wire 1P3W	Three-phase, three-wire 3P3W	Three-voltage, three-current measurement 3V3A	Three-phase, four-wire 3P4W
	$U\Sigma$ [V]		$(U1 + U3) / 2$		$(U1 + U2 + U3) / 3$
$I\Sigma$ [A]		$(I1 + I3) / 2$		$(I1 + I2 + I3) / 3$	
$P\Sigma$ [W]		$P1 + P3$			
$S\Sigma$ [VA]		$S1 + S3$	$\frac{\sqrt{3}}{2}(S1 + S3)$	$\frac{\sqrt{3}}{3}(S1 + S2 + S3)$	$S1 + S2 + S3$
$Q\Sigma$ [var]		$Q1 + Q3$			
$WP\Sigma$ [Wh]	$WP\Sigma$	$WP1 + WP3$			
	$WP+\Sigma$	$WP+1 + WP+3$			
	$WP-\Sigma$	$WP-1 + WP-3$			
$q\Sigma$ [Ah]	$q\Sigma$	$q1 + q3$			
	$q+\Sigma$	$q+1 + q+3$			
	$q-\Sigma$	$q-1 + q-3$			
$\lambda\Sigma$		$\frac{P\Sigma}{S\Sigma}$			
$\Phi\Sigma$ [°]		$\cos^{-1}\left(\frac{P\Sigma}{S\Sigma}\right)$			

Wiring diagram

There are four wiring modes available for GPM-8320-60/8330-60. Please refer to the wiring diagrams below for selecting a suitable wiring mode and wiring correctly.

Wiring IP3W

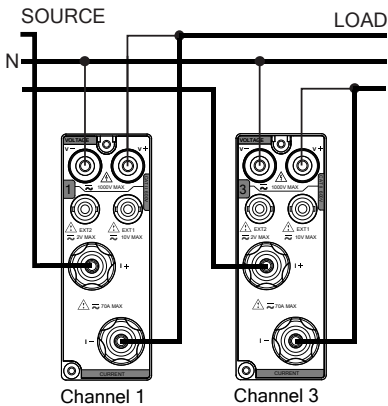

Wiring 3P3W

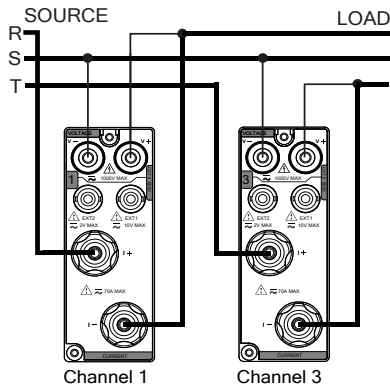

Wiring 3P4W

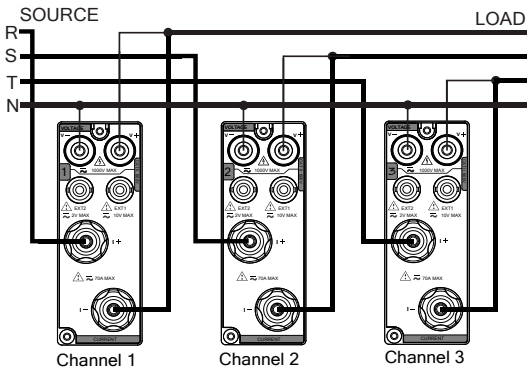

Wiring 3V3A

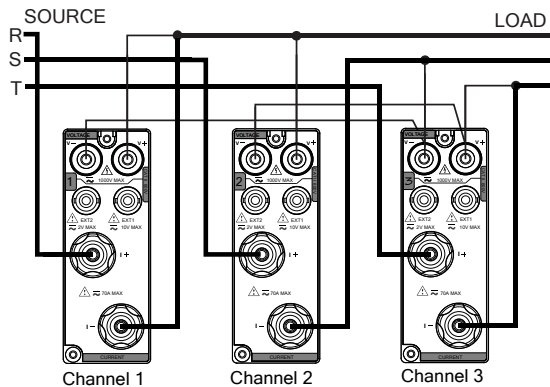

Efficiency (EFFi) Measurement

- GPM-8320-60

The GPM-8320-60/GPM-8330-60 calculates efficiency based on the measured data, where the active power measured by element1 (P1) is defined as the input power applied to the primary side of the inverter, and the active power measured by elements3 (P3) is considered as the output power consumed by the secondary side of the inverter.

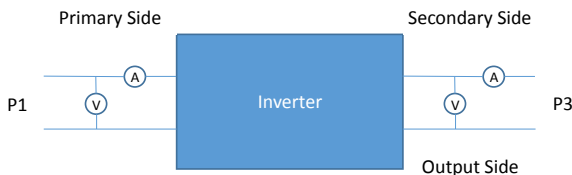

Equation

$$\text{Efficiency (EFFi)} = \frac{P3}{P1} \times 100 \%$$

- GPM-8330-60

The GPM-8330-60 calculates efficiency based on the measured data, where the active power measured by element2 (P2) is defined as the input power applied to the primary side of the inverter, and the active power measured by element1 and element3 (P1 and P3) is considered as the output power consumed by the secondary side of the inverter.

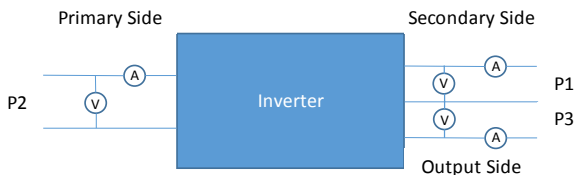

Equation

$$\text{Efficiency (EFFi)} = \frac{P1 + P3}{P2} \times 100 \%$$



Note

If the denominator of the above equation is less than or equal to 0.0001% of the rated range, the efficiency will be displayed as an error (-----)

