

Multi-Range High Power DC Source

PHU Series

USER MANUAL



ISO-9001 CERTIFIED MANUFACTURER

GW INSTEK

This manual contains proprietary information, which is protected by copyright. All rights are reserved. No part of this manual may be photocopied, reproduced or translated to another language without prior written consent of Good Will company.

The information in this manual was correct at the time of printing. However, Good Will continues to improve products and reserves the rights to change specification, equipment, and maintenance procedures at any time without notice.

Good Will Instrument Co., Ltd.
No. 7-1, Jhongsing Rd., Tucheng Dist., New Taipei City 236, Taiwan.

Table of Contents

SAFETY INSTRUCTIONS	5
GETTING STARTED	8
PHU Series Overview	10
Appearance	15
Theory of Operation	24
OPERATION	36
Set Up	38
Basic Operation	56
Parallel Operation	77
Sequence (Test Scripts)	85
CONFIGURATION	102
Menu Overview	103
Digital I/O Configuration	119
ANALOG CONTROL	125
Analog Remote Control Overview	126
Remote Monitoring	170
COMMUNICATION INTERFACE	176
Interface Configuration	177
FAQ	197
APPENDIX	198
PHU Factory Default Settings	199
Messages	201
PHU Specifications	210
PHU Dimensions	225

Certificate Of Compliance227

S SAFETY INSTRUCTIONS

This chapter contains important safety instructions that you must follow during operation and storage. Read the following before any operation to ensure your safety and to keep the instrument in the best possible condition.

Safety Symbols

These safety symbols may appear in this manual or on the instrument.



WARNING

Warning: Identifies conditions or practices that could result in injury or loss of life.



CAUTION

Caution: Identifies conditions or practices that could result in damage to the PHU or to other properties.



DANGER High Voltage



Attention Refer to the Manual



Protective Conductor Terminal



Earth (ground) Terminal



Do not dispose electronic equipment as unsorted municipal waste. Please use a separate collection facility or contact the supplier from which this instrument was purchased.

Safety Guidelines

General Guideline



CAUTION

- Do not place any heavy object on the PHU.
 - Avoid severe impact or rough handling that leads to damaging the PHU.
 - Do not discharge static electricity to the PHU.
 - Use only mating connectors, not bare wires, for the terminals.
 - Do not block the cooling fan opening.
 - Do not disassemble the PHU unless you are qualified.
-

Power Supply



WARNING

- AC Input voltage rating
PHU-C Series/200V models: 3-Phase 180 Vac to 265 Vac
PHU-D Series/400V models: 3-Phase 342 Vac to 528 Vac
 - Frequency: 47 Hz to 63 Hz
 - To avoid electrical shock connect the protective grounding conductor of the AC power cord to an earth ground.
-

Cleaning the PHU

- Disconnect the power cord before cleaning.
 - Use a soft cloth dampened in a solution of mild detergent and water. Do not spray any liquid.
 - Do not use chemicals containing harsh material such as benzene, toluene, xylene, and acetone.
-

Operation Environment

- Location: Indoor, no direct sunlight, dust free, almost non-conductive pollution (Note below)
- Relative Humidity: 20 % to 85 % (no condensation)
- Altitude: < 2000m
- Temperature: 0 °C to 50 °C

- Mains supply voltage fluctuations: +/-10 %
- Overvoltage category: OVC II
- If the equipment is used in a manner not specified by the manufacturer, the protection provided by the equipment may be impaired.
- LAN, RS232/RS485, USB, and GPIB ports are only to be connected to the circuits which are separated from mains supply by double / reinforce insulation.

(Pollution Degree) EN61010-1 and EN61010-2-030 specifies the pollution degrees and their requirements as follows. The PHU falls under degree 2.

Pollution refers to "addition of foreign matter, solid, liquid, or gaseous (ionized gases), that may produce a reduction of dielectric strength or surface resistivity".

- Pollution degree 1: No pollution or only dry, non-conductive pollution occurs. The pollution has no influence.
- Pollution degree 2: Normally only non-conductive pollution occurs. Occasionally, however, a temporary conductivity caused by condensation must be expected.
- Pollution degree 3: Conductive pollution occurs, or dry, non-conductive pollution occurs which becomes conductive due to condensation which is expected. In such conditions, equipment is normally protected against exposure to direct sunlight, precipitation, and full wind pressure, but neither temperature nor humidity is controlled.

Storage environment

- Location: Indoor
- Temperature: -25 °C to 70 °C
- Relative Humidity: ≤90% (no condensation)

Disposal



Do not dispose this instrument as unsorted municipal waste. Please use a separate collection facility or contact the supplier from which this instrument was purchased. Please make sure discarded electrical waste is properly recycled to reduce environmental impact.

GETTING STARTED

This chapter describes the power supply in a nutshell, including its main features and front / rear panel introduction. After going through the overview, please read the theory of operation to become familiar with the operating modes, protection modes and other safety considerations.



PHU Series Overview	10
Series lineup	10
Main Features	11
Accessories	12
Standard Accessories	12
Factory Installed Options	13
Optional Accessories	13
Download	14
Other	14
Appearance	15
Front Panel	15
PHU Series Display and Operation Panel	18
Sequence type	20
Rear Panel	21
Theory of Operation	24
Operating Area Description	24
CC and CV Mode	27
Slew Rate	29
Bleeder Control	29
Internal Resistance	30
Alarms	31

Considerations	32
Grounding	34

PHU Series Overview

Series lineup

The PHU series consists of 18 models, covering a number of different current, voltage and power capacities:

Model name	Voltage Rating ¹	Current Rating ²	Power
PHU 80-170	80 V	170 A	5000 W
PHU 80-340	80 V	340 A	10000 W
PHU 80-510	80 V	510 A	15000 W
PHU 200-70	200 V	70 A	5000 W
PHU 200-140	200 V	140 A	10000 W
PHU 200-210	200 V	210 A	15000 W
PHU 500-30	500 V	30 A	5000 W
PHU 500-60	500 V	60 A	10000 W
PHU 500-90	500 V	90 A	15000 W
PHU 750-20	750 V	20 A	5000 W
PHU 750-40	750 V	40 A	10000 W
PHU 750-60	750 V	60 A	15000 W
PHU 1000-15	1000 V	15 A	5000 W
PHU 1000-30	1000 V	30 A	10000 W
PHU 1000-45	1000 V	45 A	15000 W
PHU 1500-10	1500 V	10 A	5000 W
PHU 1500-20	1500 V	20 A	10000 W
PHU 1500-30	1500 V	30 A	15000 W

¹Minimum voltage guaranteed to 0.2% of rating voltage.

²Minimum current guaranteed to 0.4% of rating current.

Main Features



Performance	<ul style="list-style-type: none">• High power density: 15000W in 3U• Universal input voltage (180 to 265) Vac (C Series), (342 to 528) Vac (D Series) continuous operation.• Output voltage up to 1500V, current up to 510A.
Features	<ul style="list-style-type: none">• Active power factor correction.• Parallel master/slave operation with active current sharing.• Remote sensing to compensate for voltage drop in load leads.• 19" rack mounted ATE applications.• A built-in Web server.• OVP, OCP, OPP, UVL, and PUF protection.• Preset memory function.• Adjustable voltage and current slew rates.• Bleeder circuit ON/OFF setting.• CV, CC priority start function. (Prevents overshoot with output ON)• Supports test scripts.
Interface	<ul style="list-style-type: none">• Built-in LAN and USB interface.• Isolated analog control programming and monitoring interface.• Optional interfaces: RS-232&485, GPIB, CAN Bus, Device Net, Any Bus, Modbus.

Accessories

Before using the PHU power supply unit, check the package contents to make sure all the standard accessories are included.

Standard Accessories

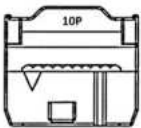
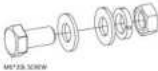
Part number	Description	Qty.	
62HU-1K0SCE01 5302-02516001	AC INPUT terminal cover (3P-200V, 5kW) (3P-400V, 5kW/10kW/15kW)	1	
62HU-1K0SC501 5302-03225001	AC INPUT terminal cover (3P-200V, 10kW/15kW)	1	
62HU-1K0SC401 62HU-1K0SC101 62HU-1K0SC201	DC OUTPUT terminal cover (PHU-80V, PHU-200V)	1	
62HU-1K0SC301 62HU-1K0SC101 62HU-1K0SC201	DC OUTPUT terminal cover (PHU-500V, PHU-750V) (PHU-1000V, PHU-1500V)	1	
62RA-423HD101	3U Handle	2	
62RA-453HP1A1	3U Bracket (Left)	1	
62RA-453HP2A1	3U Bracket (Right)	1	
39BT-50401701	SENSING connector	1	
62HU-1K0SCD01	SENSING connector cover	1	
39BT-50800601	Digital I/O control connector	1	

40LE-010SH021	Parallel control dummy connector	1	
596M-10025NS1			
6001-FN0100S1	DC OUTPUT terminal screws	1	
61PF-103220N1	(PHU-80V, PHU-200V)		
61SF-103170N1			
596M-W6020NS1	DC OUTPUT terminal screws	1	
6001-FN0060S1	(PHU-500V, PHU-750V) (PHU-1000V, PHU-1500V)		
82GW1SAFE0M*1	Safety Guide	1	
82SU-PHU00K*1	Packing list	1	
82GW-00000C*1	* CTC GW/INSTEK JAPAN USE ,RoHS	1	

Factory Installed Options

Part number	Description
PHU-IF01	GPIB interface
PHU-IF02	RS-232&RS-485 interface card (RJ45)
PHU-IF03	Isolated Digital interface card
PHU-IF04	CANbus interface card
PHU-IF05	DeviceNet interface card
PHU-IF06	Anybus adapter

(Accessories: PHU-IF03, PHU-IF04, PHU-IF05, PHU-IF06

The related information is expected to be released in October 2025.)

Optional Accessories

Part number	Description
PHU-PC01	Parallel operation cable kit for 2 units
PHU-PC02	Parallel operation cable kit for 3 units
PHU-PC03	Parallel operation cable kit for 4 units

PHU-PC04	Parallel operation cable kit for 5 units
PHU-PC05	Parallel operation cable kit for 6 units
PHU-PC06	Parallel operation cable kit for 7 units
PHU-PC07	Parallel operation cable kit for 8 units
PHU-PC08	Parallel operation cable kit for 9 units
PHU-PC09	Parallel operation cable kit for 10 units
GTL-133	Load cable, 1.5 m, 100 A
GTL-218	Load cable, 1.5 m, 200 A
GTL-219	Load cable, 3 m, 200 A
GTL-220	Load cable, 1.5 m, 300 A
GTL-221	Load cable, 3 m, 300 A
GTL-222	Load cable, 1.5 m, 400 A
GTL-223	Load cable, 3 m, 400 A
GPW-021	Input power cord, 10 AWG/4C, 3 m, UL/CSA (PHU-C-5kW, PHU-D-5kW, PHU-D-10kW, PHU-D-15kW)
GPW-022	Input power cord, 6 AWG/4C, 3 m, UL/CSA (PHU-C-10kW, PHU-C-15kW)

Download

Name	Description
PHU_cdc.inf	PHU USB CDC driver

Other

Name	Description
Certificate of traceable calibration	

Appearance

Front Panel

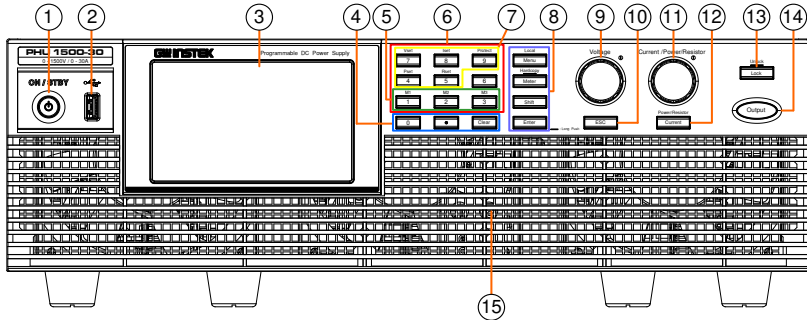

1. Power Switch ON / STBY Used to turn the power on/off.

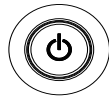

2. USB A Port USB A port for data transfer.

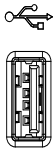

3. 5-inch TFT-LCD Display The display area.



4. Button of Paid features (+Shift) customized





- Clear Button Clear values

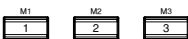

5. M1/M2/M3 Button (+Shift) Recall the M1/M2/M3 setup

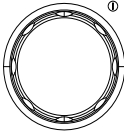
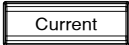
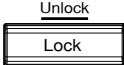
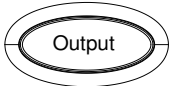

- | | | |
|-------------------|--|---|
| 6. Numeric Keypad | | Used to set various parameter values |
| 7. Vset Button | | (+Shift) Set the output voltage value |
| Iset Button | | (+Shift) Set the output current value |
| Protect Button | | (+Shift) switch to the "Protect Status" page |
| Pset Button | | (+Shift) Set the output power value |
| Rset Button | | (+Shift) Set the resistance value |
| 8. Menu Button | | PHU menu button |
| Local Button | | Switch to "Local" page. (When remote controlling) |
| Meter Button | | Switch the "Meter" page |
| Hardcopy Button | | (Long push) Copy the screenshot to the USB Storage |
| Shift Button | | Used to enable the functions that are written in blue characters above certain buttons. |
| Enter Button | | Used to enter the value. |
| 9. Voltage Knob | | Used to set the voltage value or select a parameter number in the Menu. |
| 10. Esc Button | | Function "Esc" in Menu. |

11. Current/
Power/Resist
or Knob
- Current /Power/Resistor
 Φ
- 
- Used to set the current value,
power value or resistor value.
12. Current
Button
- 
- Used to switch the page of
Power/Resistor/Current
settings.
13. Lock Button
- 
- Used to lock all front panel
buttons other than the Output
Button.
- Unlock
Button
- (Long push) Used to unlock the
front panel buttons.
14. Output
Button
- 
- Used to turn the output on or off.
15. Air Inlet
- 
- Air inlet for cooling the inside of
the PHU series.

PHU Series Display and Operation Panel

Normal type

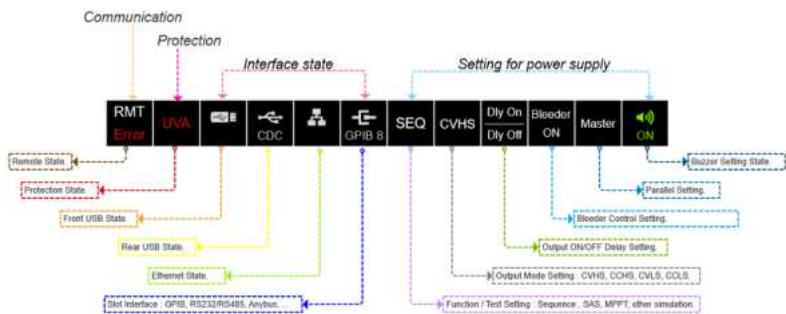
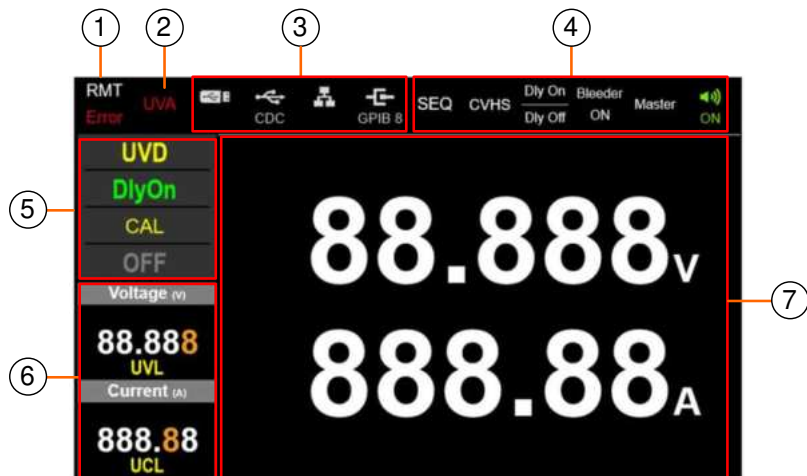

1. Block of Communication
Displays the Remote state.
2. Block of Protection
Displays the Protection state.
3. Block of interface state
 - a. Displays the Front USB state.
 - b. Displays the Rear USB state.
 - c. Displays the Ethernet state.

- d. Displays the GPIB, RS232/RS485 and Anybus state.
- 4. Block of setting
 - a. Displays the Function/Test Setting: Sequence, SAS and other simulation
 - b. Displays the Output Mode Setting: CVHS, CCHS, CVLS, CCLS
 - c. Displays the Output On/Off Delay Setting.
 - d. Displays the Bleeder Control Setting.
 - e. Displays the Parallel Setting.
 - f. Displays the Buzzer Setting.
- 5. Block of output State
 - a. Displays the Detect State.
 - b. Displays the Delay Output State.
 - c. Displays the Fan State.
 - d. Displays the Output State.
- 6. Block of output Setting Displays the Setting of voltage, current, power, resistance
- 7. Block of Meter Displays the voltage, current, power, and the ratio of the measured value to the maximum value.(bar)

For example

(PHU 500-90):

The bar below the voltage is the ratio of the 100 V to the maximum value.(500 V)



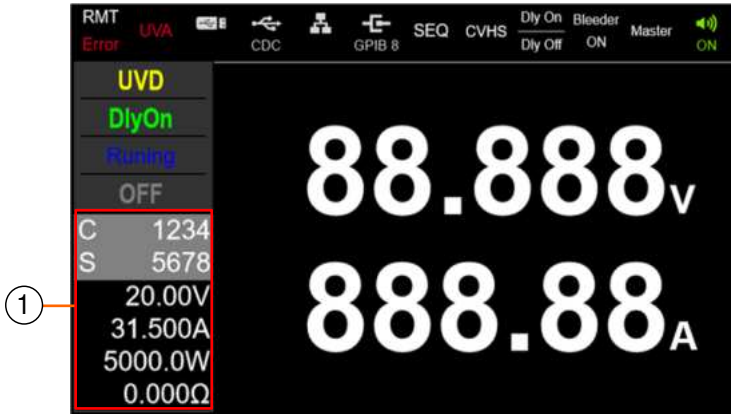

Sequence type

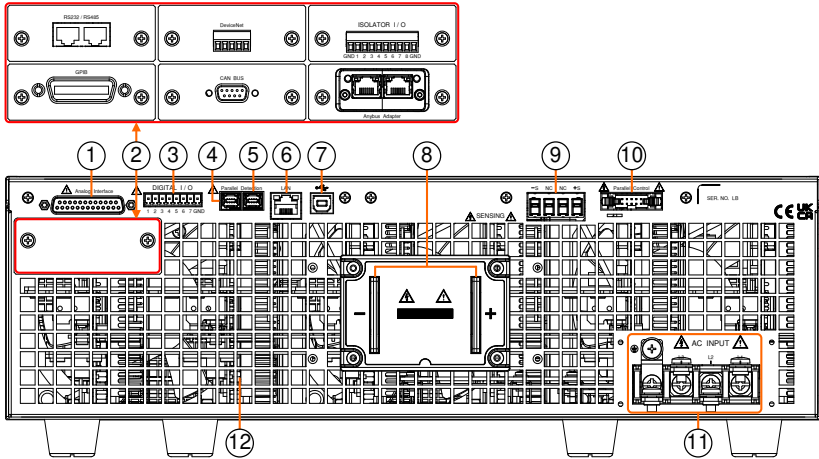

1. Block of Function Setting Displays the Setting of Function and status. (Sequence, SAS and other simulation)

Rear Panel

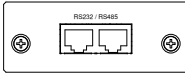
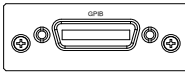
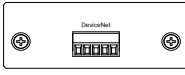
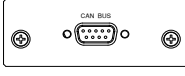
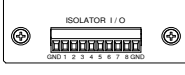
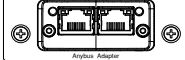

1. Analog Interface  External analog control connector.
2. Optional Interface  RS-232 & RS-485
-  GPIB
-  DeviceNet
-  CAN Bus
-  Isolated Digital I/O
-  Anybus riser (Factory Install)

- 3. Digital Interface

DIGITAL I/O

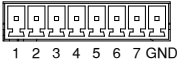

Digital I/O is an interface that adds the ability to input and output digital signals.
- 4. Parallel Port

Parallel



Mini I/O: communication in parallel (Digital Output)
- 5. Detection Port

Detection



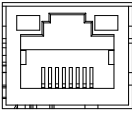

Mini I/O: communication in parallel (Digital Input)
- 6. LAN

LAN



Ethernet port for controlling the PHU remotely.
- 7. USB





USB port for controlling the PHU remotely.
- 8. DC Output

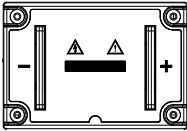

Output terminals
- 9. Sensing Terminals

-S NC NC +S

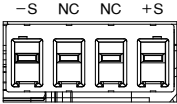

Compensation of load wire drop.
- 10. Parallel Connector

Parallel Control

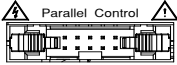

2X5 PIN Ejector header for communication in parallel (analogy)
- 11. AC Input

AC INPUT

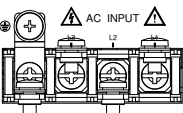

Input terminals

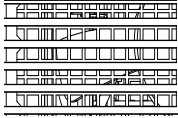
12. Air Inlet

Air inlet for cooling the inside of the PHU series.

Theory of Operation

The theory of operation chapter describes the basic principles of operation, protection modes and important considerations that must be taken into account before use.

Operating Area Description

Background The PHU power supplies are regulated DC power supplies with a high voltage and current output. These operate in CC or CV mode within a wide operating range limited only by the output power. The operating area of each power supply is determined by the rated output power as well as the voltage and current rating. Below is a comparison of the operating areas of each power supply.

PHU 80V Series Operating Area

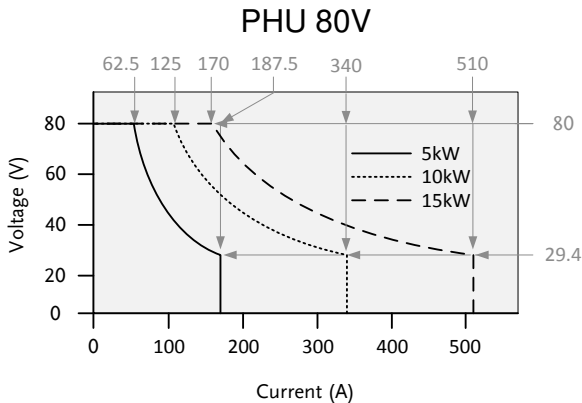

PHU 200V Series Operating Area

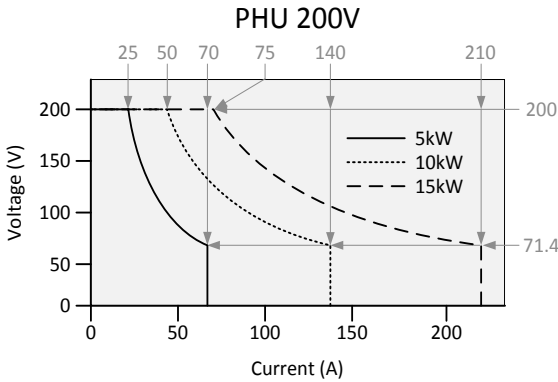

PHU 500V Series Operating Area

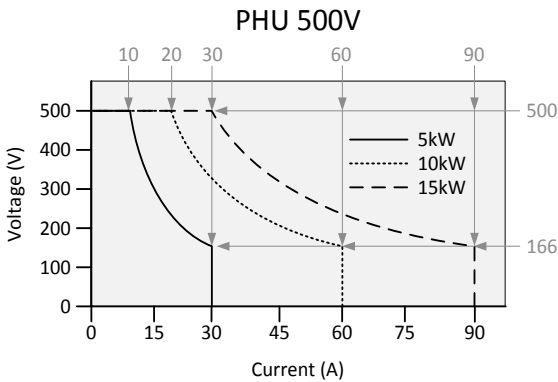

PHU 750V Series Operating Area

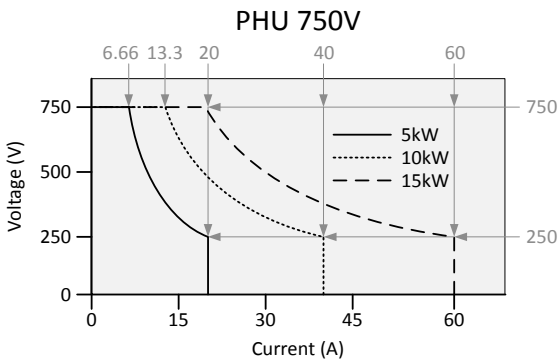

PHU 1000V Series Operating Area

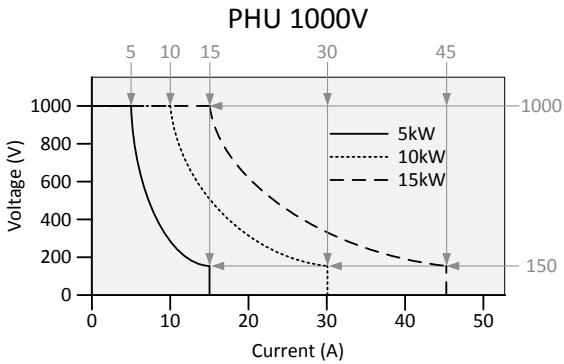

PHU 1500V Series Operating Area

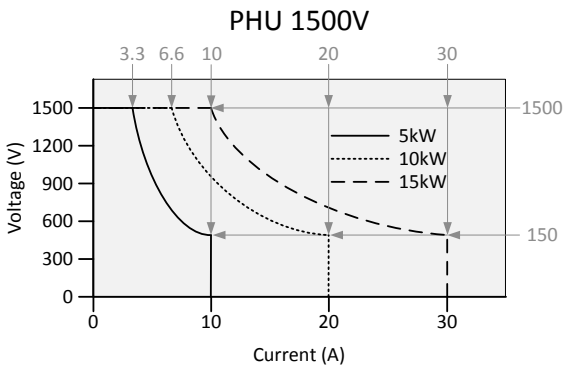

CC and CV Mode

CC and CV mode Description When the power supply is operating in constant current mode (CC) a constant current will be supplied to the load. When in constant current mode the voltage output can vary, whilst the current remains constant. When the load resistance increases to the point where the set current limit (I_{SET}) can no longer be sustained the power supply switches to CV mode. The point where the power supply switches modes is the crossover point.

When the power supply is operating in CV mode, a constant voltage will be supplied to the load, whilst the current will vary as the load varies. At the point that the load resistance is too low to maintain a constant voltage, the power supply will switch to CC mode and maintain the set current limit.

The conditions that determine whether the power supply operates in CC or CV mode depends on the set current (I_{SET}), the set voltage (V_{SET}), the load resistance (R_L) and the critical resistance (R_C). The critical resistance is determined by V_{SET}/I_{SET} . The power supply will operate in CV mode when the load resistance is greater than the critical resistance. This means that the voltage output will be equal to the V_{SET} voltage but the current will be less than I_{SET} . If the load resistance is reduced to the point that the current output reaches the I_{SET} level, the power supply switches to CC mode.

Conversely the power supply will operate in CC mode when the load resistance is less than the critical resistance. In CC mode the current output is equal to I_{SET} and the voltage output is less than V_{SET} .

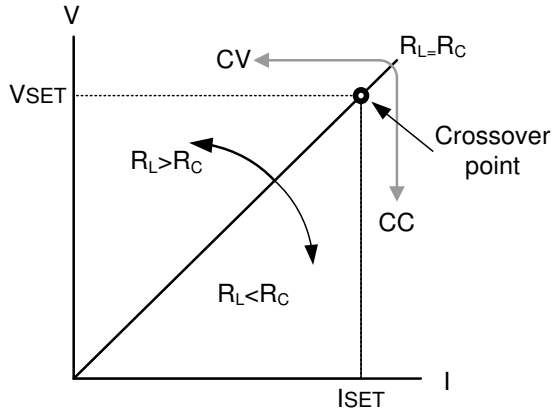

For loads that generate a transient surge voltage, V_{SET} must be set so that the surge voltage does not reach the voltage limit.

For loads in which transient peak current flows, I_{SET} must be set so that the peak value does not reach the current limit.

Slew Rate

Theory

The PHU has selectable slew rates for CC and CV mode. This gives the PHU power supply the ability to limit the current/voltage draw of the power supply. Slew rate settings are divided into High Speed Priority and Slew Rate Priority. High speed priority mode will use the fastest slew rate for the instrument. Slew Rate Priority mode allows for user adjustable slew rates for CC or CV mode. The rising and falling slew rate can be set independently.

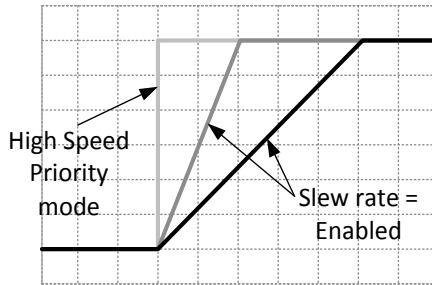

Bleeder Control

Background

The PHU DC power supplies employ a bleed resistor in parallel with the output terminals.

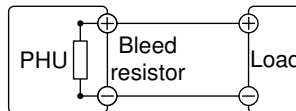

Bleed resistors are designed to dissipate the power from the power supply filter capacitors when power is turned off and the load is disconnected. Without a bleed resistor, power may remain charged on the filter capacitors for some time and be potentially hazardous.

In addition, bleed resistors also allow for smoother voltage regulation of the power supply as the bleed resistor acts as a minimum voltage load.

The bleed resistance can be turned on or off using the configuration settings.



Note

By default the bleed resistance is on. For battery charging applications, be sure to turn the bleed resistance off as the bleed resistor can discharge the connected battery when the unit is off.

Internal Resistance

Background

On the PHU, the internal resistance of the power supply can be user-defined in software. (Internal Resistance Setting, see the Settings on page 106.) When the internal resistance is set it can be seen as a resistance in series with the positive output terminal. This allows the power supply to simulate power sources that have internal resistances such as lead acid batteries. By default the internal resistance is 0 Ω .

Internal Resistance Range	Unit Model	Internal Resistance Range
	PHU 80-170	(0.0000 to 0.4706) Ω
	PHU 80-340	(0.0000 to 0.2353) Ω
	PHU 80-510	(0.0000 to 0.1569) Ω
	PHU 200-70	(0.0000 to 2.8571) Ω
	PHU 200-140	(0.0000 to 1.4286) Ω
	PHU 200-210	(0.0000 to 0.9523) Ω
	PHU 500-30	(0.000 to 16.667) Ω
	PHU 500-60	(0.000 to 8.333) Ω
	PHU 500-90	(0.0000 to 5.5556) Ω
	PHU 750-20	(0.000 to 37.500) Ω
	PHU 750-40	(0.000 to 18.750) Ω
	PHU 750-60	(0.000 to 12.500) Ω
	PHU 1000-15	(0.00 to 66.67) Ω
	PHU 1000-30	(0.000 to 33.333) Ω
	PHU 1000-45	(0.000 to 22.222) Ω
	PHU 1500-10	(0.00 to 150.00) Ω

PHU 1500-20	(0.00 to 75.00) Ω
PHU 1500-30	(0.000 to 50.000) Ω

Alarms

The PHU power supplies have a number of protection features. When one of the protection alarms is tripped, the ALM icon on the display will be lit and the type of alarm that has been tripped will be shown on the display. When an alarm has been tripped the output will be automatically turned off. For details on how to clear an alarm or to set the protection modes, please see page 56.

OVP	Over voltage protection (OVP) prevents a high voltage from damaging the load. This alarm can be set by the user.
OCP	Over current protection prevents high current from damaging the load. This alarm can be set by the user.
OPP	Over power protection prevents high power from damaging the load. This alarm can be set by the user.
PUF	Power Unit Fail. This alarm function is activated when a Power Unit is detected, Including over temperature protection.
SENSE	Sense alarm. This alarm will detect if the sense wires have been connected to the wrong polarity.
AC FAIL	AC Fail. This alarm function is activated when a low AC input is detected.
Shutdown	Force Shutdown is not activated as a result of the PHU series detecting an error. It is a function that is used to turn the output off through the application of a signal from the rear panel analog control connector when an abnormal condition occurs.

Power limit Power limit. This alarm function is activated when a power limit is detected.

Considerations

The following situations should be taken into consideration when using the power supply.

Inrush current When the power supply switch is first turned on, an inrush current is generated. Ensure there is enough power available for the power supply when first turned on, especially if a number of units are turned on at the same time.

Pulsed or Peaked loads When the load has current peaks or is pulsed, it is possible for the maximum current to exceed the mean current value. The PHU power supply ammeter only indicates mean current values, which means for pulsed current loads, the actual current can exceed the indicated value. For pulsed loads, the current limit must be increased, or a power supply with a greater capacity must be chosen. As shown below, a pulsed load may exceed the current limit and the indicated current on the power supply ammeter.

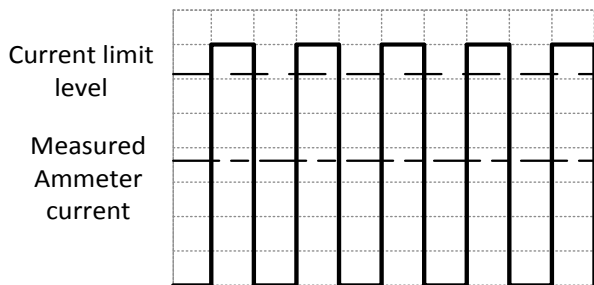

Reverse Current: Regenerative load When the power supply is connected to a regenerative load such as a transformer or inverter, reverse current will feed back to the power supply. The PHU power supply cannot absorb reverse current.

For loads that generate reverse current, connect an external resistor in parallel with the power supply to bypass the reverse current.

This description only applies when the bleed resistance is off.

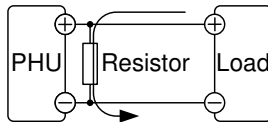

Reverse current



The current output will decrease by the amount of current absorbed by the resistor.

Ensure the resistor used can withstand the power capacity of the power supply/load.

Reverse Current: Accumulative energy. When the power supply is connected to a load such as a battery, reverse current may flow back to the power supply. To prevent damage to the power supply, use a reverse-current-protection diode in series between the power supply and load.

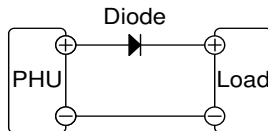



CAUTION

Ensure the reverse withstand voltage of the diode is able to withstand 2 times the rated output voltage of the power supply and the forward current capacity can withstand twice to 10 times the rated output current of the power supply.

Ensure the diode is able to withstand the heat generated in the following scenarios.

When the diode is used to limit reverse voltage, remote sensing cannot be used.

Grounding

The output terminals of the PHU power supplies are isolated with respect to the protective grounding terminal. The insulation capacity of the load, the load cables, and other connected devices must be taken into consideration when connected to the protective ground or when floating.

Floating

As the output terminals are floating, the load and all load cables must have an insulation capacity that is greater than the isolation voltage of the power supply.

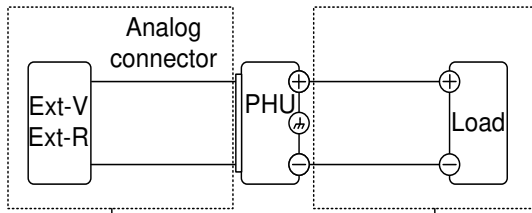

(-----) Insulation capacity \geq isolation voltage of power supply



WARNING

If the insulation capacity of the load and load cables are not greater than the isolation voltage of the power supply, electric shock may occur.

Grounded output terminal If the positive or negative terminal is connected to the protective ground terminal, the insulation capacity needed for the load and load cables is greatly reduced. The insulation capacity only needs to be greater than the maximum output voltage of the power supply with respect to ground.

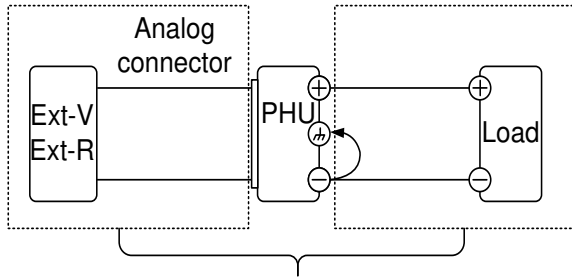

(-----) Insulation capacity \geq voltage of power supply with respect to ground



CAUTION

If using external voltage control, do not ground the external voltage terminal as this will create a short circuit.

OPERATION

Set Up	38
Line Voltage Connection.....	38
Power Up	41
Wire Gauge Considerations	43
Output Terminals	44
Using the Output Terminal Cover.....	46
Using the Rack Mount Kit.....	47
How to Use the Instrument.....	48
Reset to Factory Default Settings	52
View System Version and Build Date	54
Basic Operation.....	56
Setting OVP/OCP/OPP	56
OVP, OCP and OPP Setting Range.....	59
Delay Setting Range.....	60
Setting UVL/OVL/UCL/OCL/OPL/ORL.....	60
Setting Range	62
Setting Bleeder Control.....	63
Setting Output Mode	65
Constant Voltage (C.V.) Mode:.....	65
Constant Current (C.C.) Mode:.....	65
Setting Slew Rate Range.....	67
Panel Lock.....	68
Save (memory) Setup.....	68
Load (memory) Setup.....	70
Voltage Sense.....	71
Remote Sense Connector	72
Remote Sense Cover	73
Local Sense	74
Remote Sense	74
Parallel Operation.....	77
Master-Slave Parallel Overview.....	78
Parallel Connection.....	81
Parallel Operation	81
Sequence (Test Scripts)	85

Sequence File Format.....	86
Sequence Settings.....	86
Import Sequence from USB	87
Run Sequence	90
Export Sequence to USB.....	92
Delete Sequence.....	94
Edit Sequence	95

Set Up

Line Voltage Connection

Background The PHU power supplies support universal power input, compatible with 3-Phase (180 to 265) Vac and 3-Phase (342 to 528) Vac systems. Follow the procedure below to connect or replace the power cord (user-supplied, specifications provided below):



- Ask for professional technician for installation.
 - The permanently connected power input is used as the disconnecting device and shall remain readily operable.
 - a. A switch or circuit-breaker must be included in the installation.
 - b. It must be suitably located and easily reached.
 - c. It must be marked as the disconnecting device for the equipment.
 - d. It shall be located near the equipment.
 - e. Do not position the equipment so that it is difficult to operate the disconnecting device.
 - f. It shall not interrupt the protective earth conductor.
 - g. It shall be complied with EN 60947 series, the rated voltage shall be at least equal to the rated input voltage of the equipment and the rated current shall be equal to the rated input current of the equipment.
-

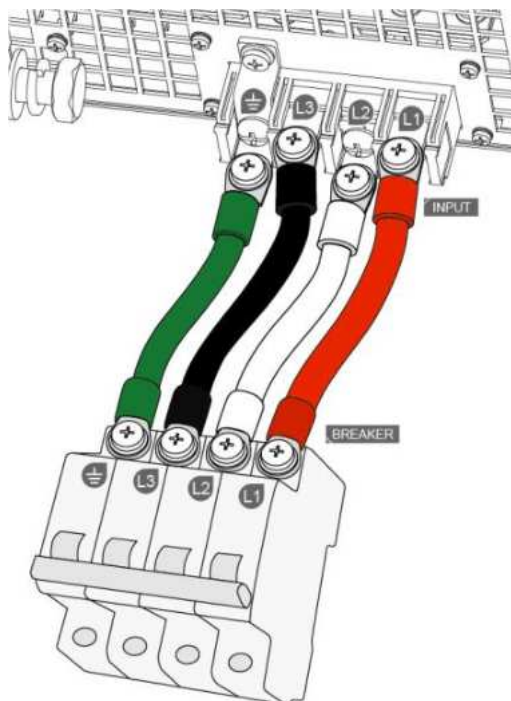

Recommended Power Cord Specifications	PHU-C type		
	5KW:	10KW:	15KW:
32A 200 V to 240 V, 8 AWG to 4 AWG, M6 screw type, screw torque value: 3.1 N.m	56A 200 V to 240 V, 6 AWG to 4 AWG, M6 screw type, screw torque value: 3.1 N.m	56A 200 V to 240 V, 6 AWG to 4 AWG, M6 screw type, screw torque value: 3.1 N.m	
	PHU-D type		
5KW:	10KW:	15KW:	
16A 380 V to 480 V, 12 AWG to 4 AWG, M6 screw type, screw torque value: 3.1 N.m	28A 380 V to 480 V, 10 AWG to 4 AWG, M6 screw type, screw torque value: 3.1 N.m	28A 380 V to 480 V, 10 AWG to 4 AWG, M6 screw type, screw torque value: 3.1 N.m	



Note

There are two type power cord protective sheaths in the standard accessories. One is M32-size and it is used for PHU-C type.

The other is M25-size and it is used for PHU-D type.

The PHU has a number of power cord options available. Please see the optional accessories on page 13 for details.

Removal

1. Turn off the power switch and circuit breaker.

ON / STBY

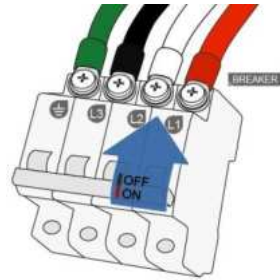

2. Unscrew the power cord protective sheath.
3. Remove the 4 screws holding the power cord cover and remove.
4. Remove the AC power cord wires with a Phillips screwdriver.

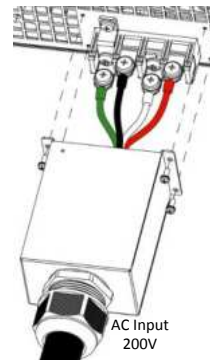
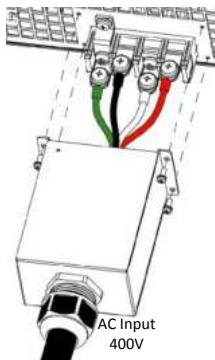

Installation

1. Connect the AC power cord wires to the AC input terminals.
 - Red → Line (L1)
 - White → Line (L2)
 - Black → Line (L3)
 - Green / Green & Yellow → Ground (⊕)
- Wire gauge: Please refer to the Recommended Power Cord Specifications.
- Wire diameter: Please refer to the Recommended Power Cord Specifications.

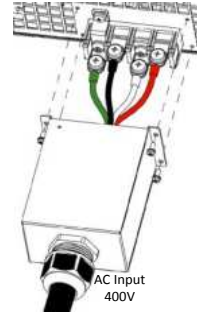

2. Make sure the sheath is tightened to the lock nut.
3. Re-install the power cord cover.

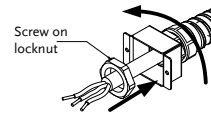

Power Up

Steps

1. Connect the power cord to the universal power input.
2. Press the ON/STBY button.
3. The button light will change from red to orange, and finally to green.
4. The power supply screen will display the GW Instek logo startup screen when it is powered on.

Page 41

ON / STBY





Note

You may also configure how the PHU will behave on startup by altering the Power On Configuration settings, see page 112.

Power Down

To turn off the PHU power supply, press the ON/STBY button again. The button light will change from green to orange, and then to red. It may take a few seconds for the power supply to fully power down.



CAUTION

The power supply takes around 8 seconds to fully turn on or shutdown.

Do not turn the power on and off quickly. Please wait for the display to fully turn off.

The power switch that is included in the instrument is not considered a disconnecting device.

The circuit breaker/switch on the fixed wiring is used as the disconnecting device.

Wire Gauge Considerations

Background Before connecting the output terminals to a load, the wire gauge of the cables should be considered.

It is essential that the current capacity of the load cables is adequate. The rating of the cables must equal or exceed the maximum current rated output of the instrument.

Recommended wire gauge

Wire Gauge	Nominal Cross Section	Maximum Current
20	0.5	9
18	0.75	11
18	1	13
16	1.5	18
14	2.5	24
12	4	34
10	6	45
8	10	64
6	16	88
4	25	120
2	32	145
1	50	190
00	70	240
000	95	290
0000	120	340

The maximum operation current depends on the maximum allowable temperature of the insulation on the cable.

Under this condition, above table figures the maximum current that insulation's temperature rise should be under 60 degree and ambient temperature must be less than 30 degrees.

To minimize noise pickup or radiation, the load wires and remote sense wires should be twisted-pairs of the shortest possible length. Shielding of the sense leads may be necessary in high noise

environments. Where shielding is used, connect the shield to the chassis via the rear panel ground screw. Even if noise is not a concern, the load and remote sense wires should be twisted-pairs to reduce coupling, which might impact the stability of the power supply. The sense leads should be separated from the power leads.

Output Terminals

Background Before connecting the output terminals to the load, first consider whether voltage sense will be used, the gauge of the cable wiring and the withstand voltage of the cables and load.

The output terminals are of two types:

- Two solid bars equipped with M10-size bolt and nuts for low-voltage output models. (PHU-80, PHU-200)
- Two solid bars equipped with M6-size bolt and nuts for high-voltage output models. (PHU-500, PHU-750, PHU-1000, PHU-1500)



WARNING

Dangerous voltages. Ensure that the power to the instrument is disabled before handling the power supply output terminals. Failing to do so may lead to electric shock.

Steps

1. Turn the power off.

ON / STBY



2. Remove the output terminal cover. Page 46

3. If necessary, connect the chassis ground terminal to either the positive or negative terminal. See Page 34 the grounding chapter for details.

4. Choose a suitable wire gauge and crimping terminal for the load cables. Page 43
5. Connect the positive load cable to the positive output terminal and the negative cable to the negative output terminal.
6. Reattach the output terminal cover. Page 46

Connection
Example

Use the included bolt set to connect the load cables to the output terminals.

(PHU-80, PHU-200 : M10-size bolt)

(PHU-500, PHU-750, PHU-1000, PHU-1500 : M6-size bolt)

Make sure that the connections are tight and that washers and spring washers are used to ensure a good connection.

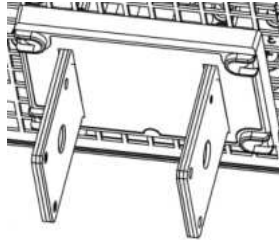

Low voltage output model

The user can use M10-sized screws and corresponding sized nuts to secure the load cables

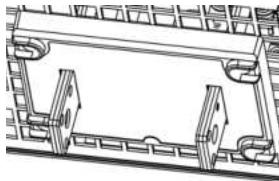

High voltage output model

The user can use M6-sized screws and corresponding sized nuts to secure the load cables

Using the Output Terminal Cover

- Steps
1. Unscrew the 4 screws beside the terminals.
 2. Put the cover on the terminal.
 3. Tighten the screws to secure the cover over the terminals.

(PHU-80V, 200V)

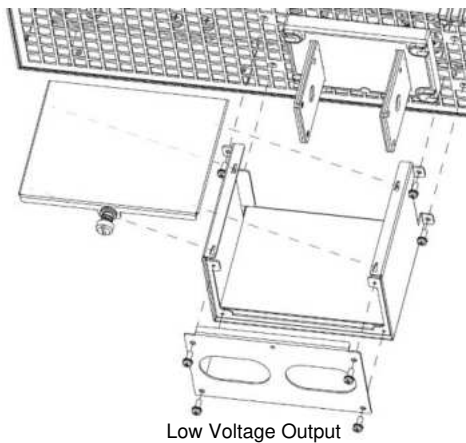

Low Voltage Output

(PHU-500V,
750V,1000V,
1500V)

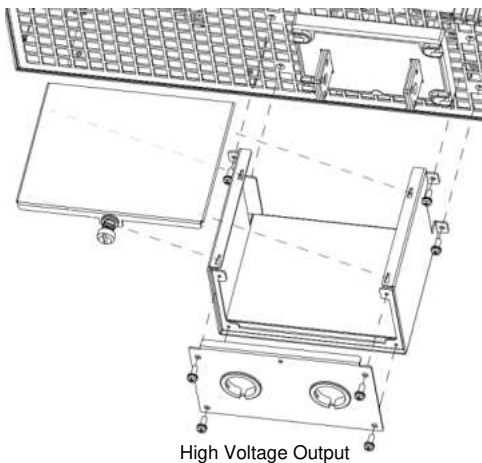

High Voltage Output

- Removal
- Reverse the procedure to remove the terminal covers.

Using the Rack Mount Kit

Background

The PHU series are designed to be directly mounted into 19 inch 3U rack mounts.

The PHU can be equipped with handles for easy installation in a rack.

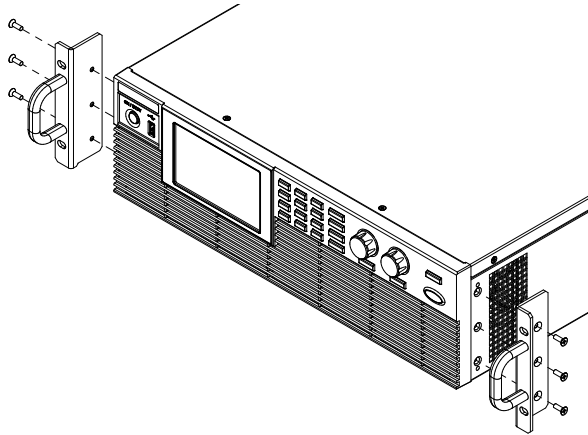

How to Use the Instrument

Background The PHU power supplies use the voltage, current knobs, number pad and some buttons to configure parameter values.

The voltage knobs are used to select the option in the main menu.

When the user manual says to set a value or parameter, use the steps below.

Example Set a voltage of 10.05 volts.

There are 3 methods to set the voltage value.

Method 1 1. Repeatedly press the Voltage knob until the target digit is highlighted. This will allow the voltage to be edited in 1 volt steps.

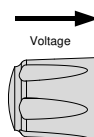

2. Turn the Voltage knob till 10 volts is shown on the voltage display.

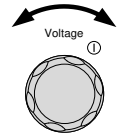

3. Repeatedly press the Voltage knob until the target digit is highlighted. This will allow the voltage to be edited in 0.01 volt steps.

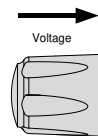

4. Turn the Voltage knob till 10.05 volts is shown on the voltage display.

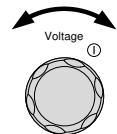

Method 2

1. Press the Shift button and then press the 7 button in the number pad.



+

Vset

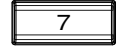

It will be a place that can use the number pad to set the value directly.



2. Press the Enter button after keying in the value.

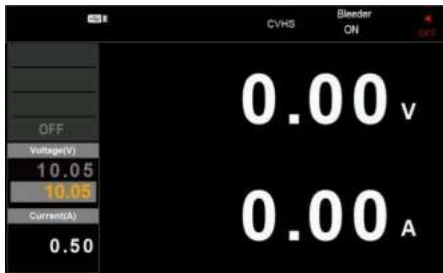
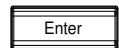

Method 3

1. Press the Menu button to enter the Menu page.

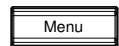

2. Press the Voltage knob to enter the Settings page.

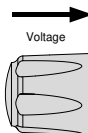

3. Press the Voltage knob to enter the Presets page.

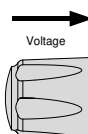
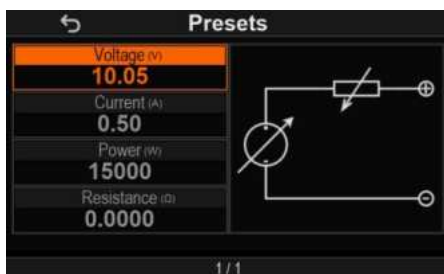

4. Press the Voltage knob, and it will be a place that can use the number pad to set the value directly.

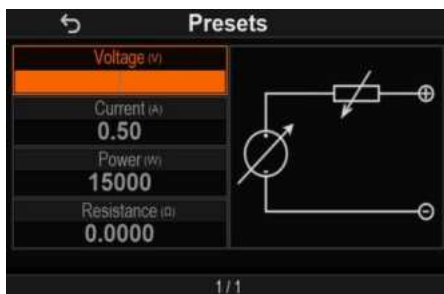

5. Press the Enter button after keying in the value.
Press the ESC button to return to the previous page.



Note

Press the Shift button and it will become illuminated to enable the functions that are written in blue characters above certain buttons.

Reset to Factory Default Settings

Background The setting allows the PHU to be reset back to the factory default settings. See page 199 for the default factory settings.

Steps

1. Press the Menu button.

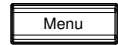

2. Rotate the Voltage knob to choose the "System" icon.

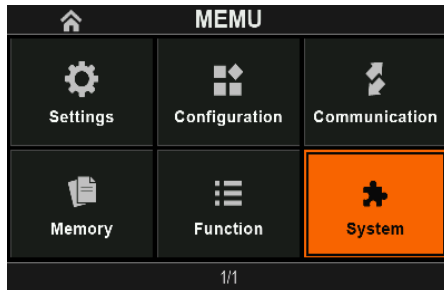
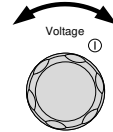

3. Press the Voltage knob to enter System Page.

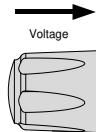

4. Rotate the Voltage knob to choose the “Factory default” icon.

(There are two pages in the “System”)

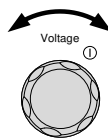

5. Press the Voltage knob.

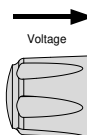

6. Rotate the Voltage knob to choose “Reset” in this window.

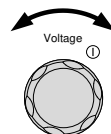

7. Press the Voltage knob to confirm Reset.

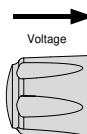

View System Version and Build Date

Background The setting allows you to view the PHU version number, build date, serial number and the module.

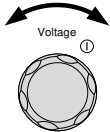
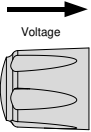
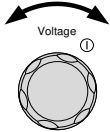
- Steps**
1. Press the Menu button. 
 2. Rotate the Voltage knob to choose the "System" icon. 
-
3. Press the Voltage knob to enter System Page. 
 4. Rotate the Voltage knob to choose the "About" icon. 
-

- Press the Voltage knob.
The information of the version is in the window.

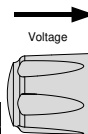

Example

Operating System Version: 4.14.20241121



version

Build Date: November 21, 2024

Example

Software Version:01.34



version

Example

Firmware Version:065222A0



version

Basic Operation

This section describes the basic operations required to operate the power supply.

- Setting OVP/OCP/OPP → from page 56
- Setting UVL/OVL/UCL/OCL/OPL/ORL → from page 60
- Setting Bleeder Control → from page 63
- Setting Output mode → from page 65
- Panel lock → from page 68
- Save (memory) Setup → from page 68
- Load (memory) Setup → from page 70
- Voltage Sense → from page 71



Note

The images appearing in this chapter are for reference only. The actual selectable range depends on the PHU model.

Before operating the power supply, please see the Getting Started chapter, page 8.

Setting OVP/OCP/OPP

Background

The OVP level, OCP level and OPP level have a selectable range that is based on the output voltage and output current, respectively. The OVP, OCP and OPP levels are set to the highest level by default. The actual selectable OVP, OCP and OPP range depends on the PHU model.

When one of the protection measures is on, the block of protection state is shown status on the screen. Pressing the enter button can resume. The "Shift"+"9" can be used to check protection that has been tripped, it can also clear any protection alarm. By default, the output will turn off when the protection levels are tripped.

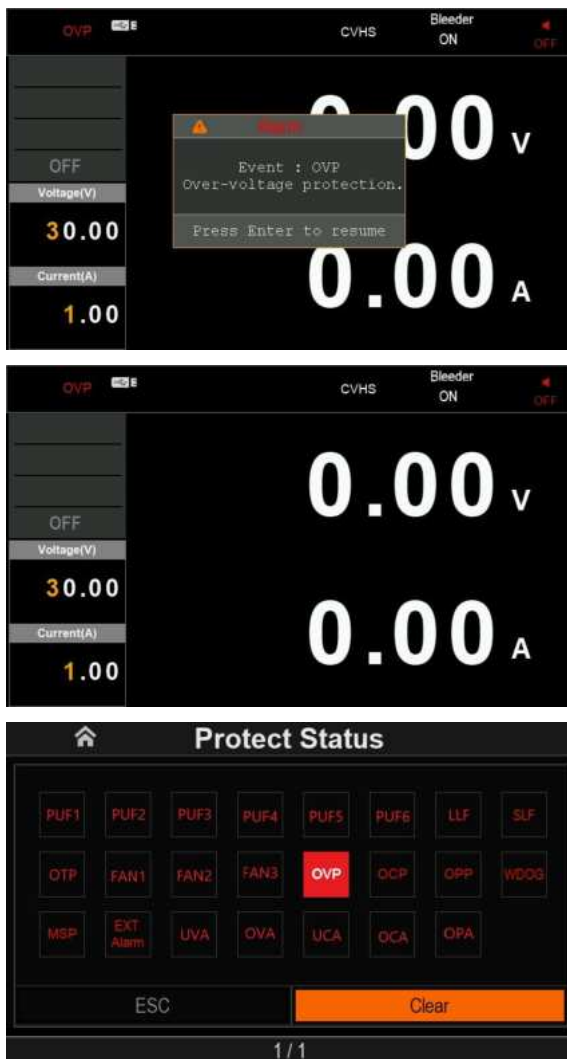

Example

OVP alarm

Before setting the protection settings:

- Ensure the load is not connected.
- Ensure the output is turned off.

You can use the "Protection" settings to set up the

values of OVP (over voltage protection), OCP (over current protection), OPP (over power protection) and each their Delay(s).

Steps

1. Press the Menu button to enter the main menu.

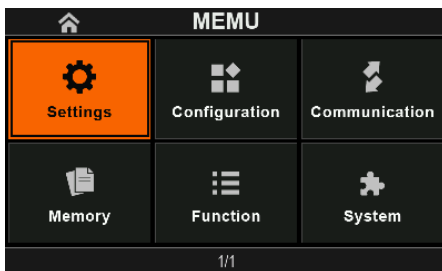
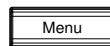

2. Press the Voltage knob to enter the Settings Page and rotate the Voltage knob to choose the "Protection" icon.

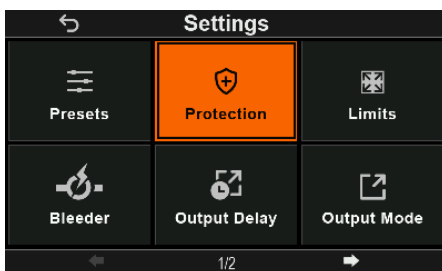
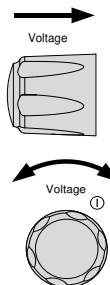

3. Press the Voltage knob to enter the Protection Page.

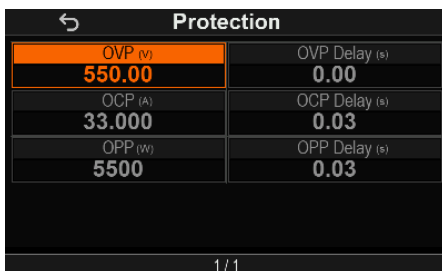
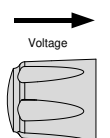

Choose a Protection Function

- Then you can choose the OVP, OCP, and OPP settings by rotating the Voltage knob.

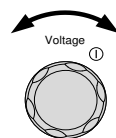

Setting the Protection Level

- Press the Voltage knob and key in the value by number pad. Press the voltage knob again to enter the value.



- If the setting is complete, press the ESC key to go back to the previous page.



OVP, OCP and OPP Setting Range

PHU Model	OVP	OCP	OPP
80-170	(5.00 to 88.00) V	(5.00 to 187.00) A	(100 to 5500) W
200-70	(5.00 to 220.00) V	(5.00 to 77.00) A	(100 to 5500) W
500-30	(5.00 to 550.00) V	(3.00 to 33.00) A	(100 to 5500) W
750-20	(5.0 to 825.0) V	(2.00 to 22.00) A	(100 to 5500) W
1000-15	(5.0 to 1100.0) V	(1.500 to 16.500) A	(100 to 5500) W
1500-10	(5.0 to 1650.0) V	(1.000 to 11.000) A	(100 to 5500) W
80-340	(5.00 to 88.00) V	(5.00 to 374.00) A	(200 to 11000) W
200-140	(5.00 to 220.00) V	(5.00 to 154.00) A	(200 to 11000) W
500-60	(5.00 to 550.00) V	(5.00 to 66.00) A	(200 to 11000) W
750-40	(5.0 to 825.0) V	(4.000 to 44.000) A	(200 to 11000) W
1000-30	(5.0 to 1100.0) V	(3.000 to 33.000) A	(200 to 11000) W
1500-20	(5.0 to 1650.0) V	(2.000 to 22.000) A	(200 to 11000) W

80-510	(5.00 to 88.00) V	(5.00 to 561.00) A	(300 to 16500) W
200-210	(5.00 to 220.00) V	(5.00 to 231.00) A	(300 to 16500) W
500-90	(5.00 to 550.00) V	(5.00 to 99.00) A	(300 to 16500) W
750-60	(5.0 to 825.0) V	(5.00 to 66.00) A	(300 to 16500) W
1000-45	(5.0 to 1100.0) V	(4.5 to 49.500) A	(300 to 16500) W
1500-30	(5.0 to 1650.0) V	(3 to 33.000) A	(300 to 16500) W

Delay Setting Range

PHU Model	OVP Delay	OCP Delay	OPP Delay
All series	(0.0 to 2.0) s	(0.1 to 2.0) s	(0.1 to 2.0) s

Setting UVL/OVL/UCL/OCL/OPL/ORL

Background

You can use the “Limits” settings to apply limits to the voltage, current, power and Resistance settings respectively.

For example, if the Over Voltage limit is set to 88.888V, and the output voltage is adjusted beyond this value, the screen will display “OVL” and the value cannot exceed this limit.



By using this feature, you can avoid turning the output off by mistakenly setting the voltage or current to a value that exceeds the set OVP or OCP level or to a value that is lower than the set UVL trip point.

You can use the “Limits” settings to set up the values of UVL (Under voltage Limit), OVL (Over Voltage Limit), UCL (Under Current Limit),

OC (Over Current Limit), OPL (Over power Limit) and ORL (Over Resistance Limit)

Steps

1. Press the Menu button to enter the main menu.

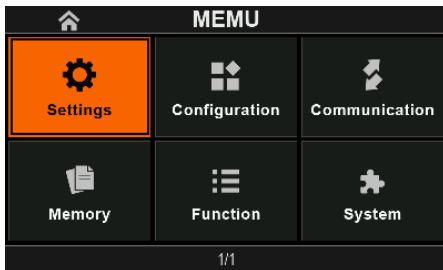
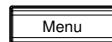

2. Press the Voltage knob to enter the Settings Page and rotate the Voltage knob to choose the "Limits" icon.

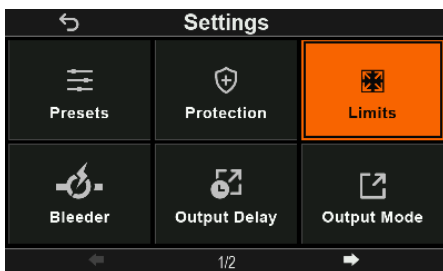
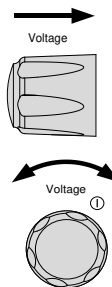

3. Press the Voltage knob to enter the Limits Page.

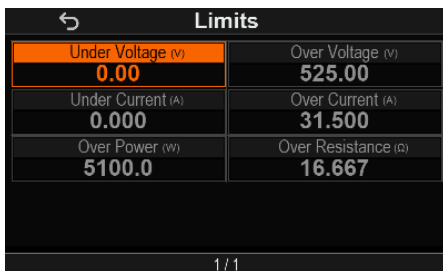
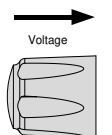

4. Then you can choose the UVL, OVL, UCL, OCL, OPL and ORL settings by rotating the Voltage knob.

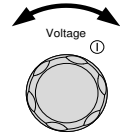

5. Press the Voltage knob and key in the value by number pad. Press the voltage knob again to enter the value.

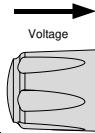

6. If the setting is complete, press the ESC key to go back to the previous page.



Setting Range

PHU Model	UVL & OVL	UCL & OCL	OPL	ORL
80-170	(0.00 to 84.00) V	(0.00 to 178.50) A	(0 to 5100) W	(0 to 0.4706) Ω
200-70	(0.00 to 210.00) V	(0.00 to 73.50) A	(0 to 5100) W	(0 to 2.8571) Ω
500-30	(0.00 to 525.00) V	(0.000 to 31.500) A	(0 to 5100) W	(0 to 16.667) Ω
750-20	(0.0 to 787.5) V	(0.000 to 21.000) A	(0 to 5100) W	(0 to 37.5) Ω
1000-15	(0.0 to 1050.0) V	(0.000 to 15.750) A	(0 to 5100) W	(0 to 66.6667) Ω
1500-10	(0.0 to 1575.0) V	(0.000 to 10.500) A	(0 to 5100) W	(0 to 150) Ω
80-340	(0.00 to 84.00) V	(0.00 to 357.00) A	(0 to 10200) W	(0 to 0.2352) Ω
200-140	(0.00 to 210.00) V	(0.00 to 147.00) A	(0 to 10200) W	(0 to 1.4286) Ω
500-60	(0.00 to 525.00) V	(0.00 to 63.30) A	(0 to 10200) W	(0 to 8.3333) Ω
750-40	(0.0 to 787.5) V	(0.000 to 42.000) A	(0 to 10200) W	(0 to 18.75) Ω
1000-30	(0.0 to 1050.0) V	(0.000 to 31.500) A	(0 to 10200) W	(0 to 33.3333) Ω
1500-20	(0.0 to 1575.0) V	(0.000 to 21.000) A	(0 to 10200) W	(0 to 75) Ω

80-510	(0.00 to 84.00) V	(0.00 to 535.50) A	(0 to 15300) W	(0 to 0.1569) Ω
200-210	(0.00 to 210.00) V	(0.00 to 220.50) A	(0 to 15300) W	(0 to 0.9524) Ω
500-90	(0.00 to 525.00) V	(0.00 to 94.50) A	(0 to 15300) W	(0 to 5.5556) Ω
750-60	(0.0 to 787.5) V	(0.00 to 63.00) A	(0 to 15300) W	(0 to 12.5) Ω
1000-45	(0.0 to 1050.0) V	(0.000 to 47.250) A	(0 to 15300) W	(0 to 22.2222) Ω
1500-30	(0.0 to 1575.0) V	(0.000 to 31.500) A	(0 to 15300) W	(0 to 50) Ω

Setting Bleeder Control

Background The Bleeder function helps to quickly discharge the internal capacitor, eliminating the potential danger of discharge. For battery charging applications, the Bleeder can be set to OFF to prevent any impact on the charging process.

Bleeder control turns ON/OFF the bleeder resistor. When set to AUTO the bleeder resistor is automatically turned on when the output is turned on and turned off when the output or power is turned off.

- Steps**
1. Press the Menu button to enter the main menu.

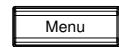

2. Press the Voltage knob to enter the Settings Page and rotate the Voltage knob to choose the "Bleeder" icon.

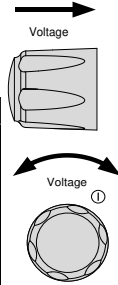
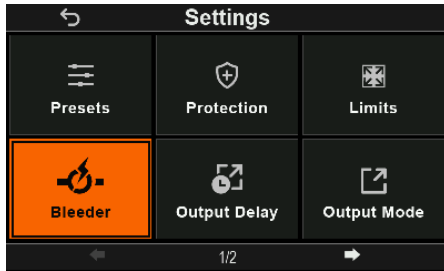

3. Press the Voltage knob to enter the Bleeder Page.

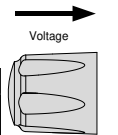
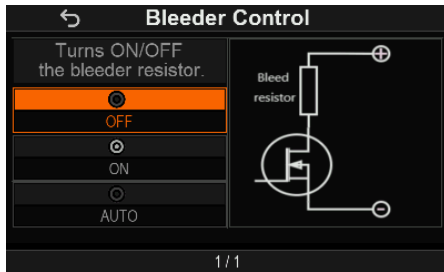

4. Users can choose the OFF, ON, and AUTO by rotating the Voltage knob.

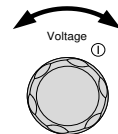

5. Press the Voltage knob to complete selection

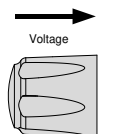

6. If the setting is complete, press the ESC key to go back to the previous page.



Setting Output Mode

Constant Voltage (C.V.) Mode:

When the power supply is set to **Constant Voltage (C.V.)** mode, a current limit must also be set to determine the crossover point. Once the current exceeds this limit, the mode switches to **Constant Current (C.C.)** mode.

- C.V. Mode Types
1. **CVHS Mode (CV High Speed Priority)**
 - Uses the fastest slew rate for the instrument.
 2. **CVLS Mode (CV Slew Rate Priority)**
 - Uses a user-configured slew rate. (Users can set the rising voltage and falling voltage)

Constant Current (C.C.) Mode:

When the power supply is set to **Constant Current (C.C.)** mode, a voltage limit must be set to determine the crossover point. Once the voltage exceeds this limit, the mode switches to **Constant Voltage (C.V.)** mode.

- C.C. Mode Types
1. **CCHS Mode (CC High Speed Priority)**
 - Uses the fastest slew rate for the instrument.
 2. **CCLS Mode (CC Slew Rate Priority)**
 - Uses a user-configured slew rate. (Users can set the rising current, and falling current)

For details about C.C. operation, see page 27. C.C. and C.V.

There are a total of four modes, and the user can choose which mode to use based on their needs.

- Background
- Before setting the Output mode, ensure that:
- The output is off.
 - The load is connected.
-

- Steps
1. Press the Menu button to enter the

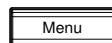

main menu.

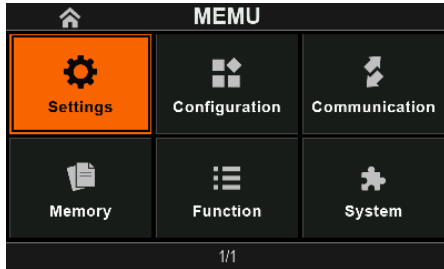

2. Press the Voltage knob to enter the Settings Page and rotate the Voltage knob to choose the "Output Mode" icon.

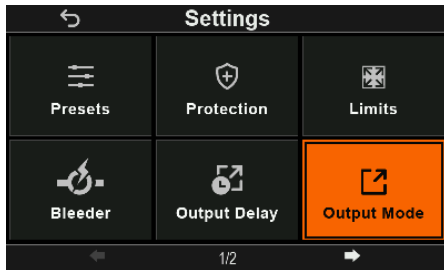
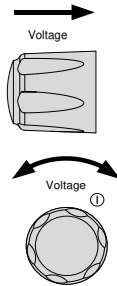

3. Press the Voltage knob to enter the Output Mode Page.

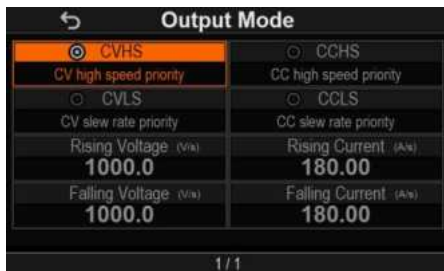
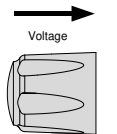

4. Users can choose the Output Mode by rotating the Voltage knob. Press the Voltage knob to complete selection.

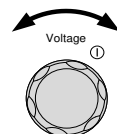

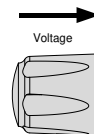

5. If the user selects the CVLS mode or CCLS mode, they can use the number pad to adjust the rising voltage, falling voltage, rising current, and falling current.

(Rotate the voltage knob to select the parameter to be set. Press the voltage knob, then use the number pad to enter the value. Press the voltage knob again to enter the value.)

6. If the setting is complete, press the ESC key to go back to the previous page.

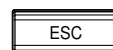

Setting Slew Rate Rage

PHU Model	Voltage-Slew rate	Current-Slew rate
80-170	(0.01 to 160.00) V/S	(0.01 to 340.00) A/S
200-70	(0.01 to 400.00) V/S	(0.01 to 140.00) A/S
500-30	(0.1 to 1000.0) V/S	(0.001 to 60.000) A/S
750-20	(0.1 to 1500.0) V/S	(0.001 to 40.000) A/S
1000-15	(0.1 to 2000.0) V/S	(0.001 to 30.000) A/S
1500-10	(0.1 to 3000.0) V/S	(0.001 to 20.000) A/S
80-340	(0.01 to 160.00) V/S	(0.1 to 680.0) A/S
200-140	(0.01 to 400.00) V/S	(0.01 to 280.00) A/S
500-60	(0.1 to 1000.0) V/S	(0.01 to 120.0) A/S
750-40	(0.1 to 1500.0) V/S	(0.01 to 80.00) A/S
1000-30	(0.1 to 2000.0) V/S	(0.001 to 60.000) A/S
1500-20	(0.1 to 3000.0) V/S	(0.001 to 40.000) A/S
80-510	(0.01 to 160.00) V/S	(0.1 to 1020.0) A/S
200-210	(0.01 to 400.00) V/S	(0.01 to 420.00) A/S
500-90	(0.1 to 1000.0) V/S	(0.01 to 180.00) A/S

750-60	(0.1 to 1500.0) V/S	(0.01 to 120.00) A/S
1000-45	(0.1 to 2000.0) V/S	(0.01 to 90.00) A/S
1500-30	(0.1 to 3000.0) V/S	(0.001 to 60.000) A/S

Panel Lock

The panel lock feature prevents settings from being changed accidentally. When activated, the Lock key will become illuminated and all keys and knobs except the Lock key and Output key (if active) will be disabled.

If the instrument is remotely controlled via the USB/LAN interface, the panel lock is automatically enabled.

Activate the panel lock Press the Lock key to activate the panel lock. The key will become illuminated.

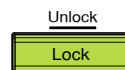

Disable the panel lock Hold the Lock key for 3 seconds to disable the panel lock. The key's light will turn off.

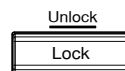

Save (memory) Setup

The PHU has 3 memory slots (M1, M2, M3) to save the various settings. Including Voltage, Current, Power, Resistance, OVP, OVP Delay, OCP, OCP Delay, OPP, OPP Delay, UVL, OVL, UCL, OCL, OPL, ORL, Bleeder Control and so on.

Steps 1. Press the Menu button to enter the main menu.

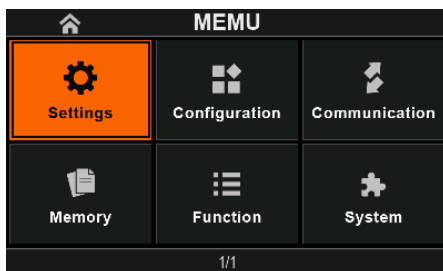
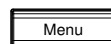

2. Press the Voltage knob to enter the Settings Page and rotate the Voltage knob to choose the "Save to Memory" icon. (On second page)

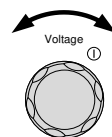
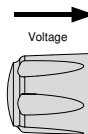

3. Press the Voltage knob to enter the Save to Memory Page.

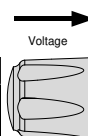
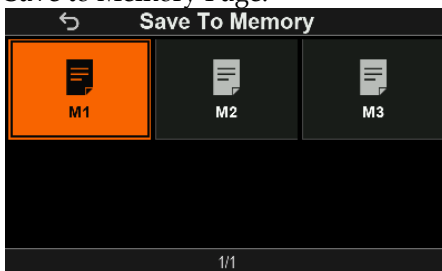

4. Users can choose the memory slot (M1, M2, M3) using the voltage knob, then press the voltage knob again to complete setting.
5. If the setting is complete, press the ESC key to go back to the previous page.

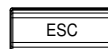

Load (memory) Setup

The PHU has 3 memory slots (M1, M2, M3) to load setups.

Steps

1. Press the Menu button to enter the main menu.

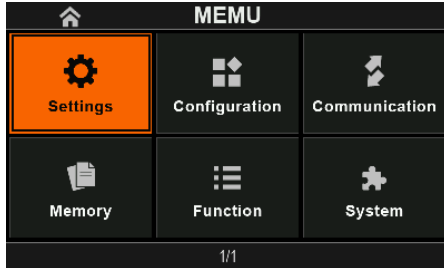

2. Rotate the Voltage knob to choose the "Memory" icon.

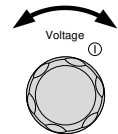

3. Press the Voltage knob to enter the Memory Page and rotate the Voltage knob to choose the memory slots.(M1, M2, M3)

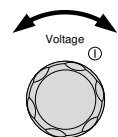
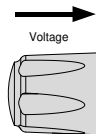

4. (For example, M1) Press the Voltage knob to enter the M1 Page.



5. Rotate the Voltage knob to choose the “Load” icon. And Press the Voltage knob to complete loading memory.



6. If the setting is complete, press the ESC key to go back to the previous page.

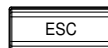

Voltage Sense

The PHU power supplies can be operated using remote voltage sense. By default the PHU ships configured for local sense.

Remote Sense Connector

The Remote Sense connector includes a detachable plug to facilitate making the sense connections.



WARNING

Ensure the output is off before handling the remote sense connector.

Use sense cables with a voltage rating exceeding the isolation voltage of the power supply.

Never connect sensing cables when the output is on. Electric shock or damage to the power supply could result.

Remote Sense Connector Overview

When using the remote sense connector make sure the wires that are used follow the following guidelines:

Wire gauge: AWG 30 to AWG 8

Wire diameter: 0.2 mm² to 6 mm²

Strip length: 10 mm to 11 mm

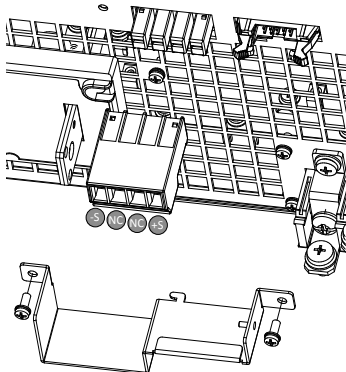

- +S: Remote(+) sense
- NC: Not connected
- NC: Not connected
- S: Remote (-) sense

Remote Sense Cover

Local sense is only recommended when the voltage drop is of no consequence or for load-current applications. By default, the sense plug is already configured to local sensing.



WARNING

Ensure that the output is off before handling the remote sense connector.

Use sense cables with a voltage rating exceeding the isolation voltage of the power supply.

Never connect sensing cables when the output is on. Electric shock or damage to the power supply could result.

Always operate the PHU with the remote sense cover.

Connector

1. Place the cover over the remote sense connector.
2. Secure the cover with the provided screw.

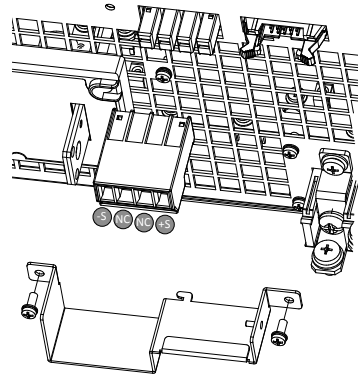

Local Sense

Local sense is only recommended when the voltage drop is of no consequence or for load-current applications. By default, the sense plug is already configured to local sensing.

Local Sense Connection

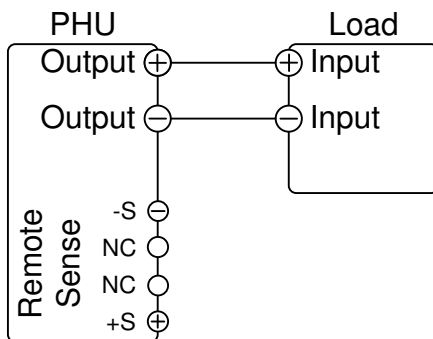

Remote Sense

Remote sense is used to compensate for the voltage drop seen across load cables due to the resistance inherent in the load cables. The remote sense terminals are connected to the load terminals of the DUT to determine the voltage drop across the load cables.

Model Range	Maximum Compensation Voltage (V)
PHU 80-170/ 80-340/ 80-510	4 V
PHU 200-70/ 200-140/ 200-210	10 V
PHU 500-30/ 500-60/ 500-90	25 V
PHU 750-20/ 750-40/ 750-60	37.5 V
PHU 1000-15/ 1000-30/ 1000-45	50 V
PHU 1500-10/ 1500-20/ 1500-30	75 V

Load cables should be chosen with a voltage drop less than the compensation voltage.

Do NOT bundle the sense wire-pair together with the load wires; keep the load wires and sense wires separate. Keep the sense wire-pair as short as possible and twist or bundle it to reduce lead inductance and noise pickup.

**WARNING**

Ensure the output is off before connecting any sense cables.

Use sense cables with a voltage rating exceeding the isolation voltage of the power supply.

Never connect sensing cables when the output is on. Electric shock or damage to the power supply could result.

Always connect the + sense lead to the + terminal of the load and the - sense lead to the - terminal of the load. If a sense lead opens during operation the output may momentarily overshoot. The two center sense terminals are not used.

Single Load

1. Connect the +S terminal to the positive potential of the load. Connect the -S terminal to the negative potential of the load.

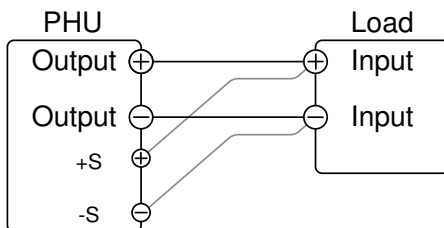

2. Operate the instrument as normal. See the Basic Operation chapter for details.

Parallel PHU Units

1. Connect the +S terminals to the positive potential of the load. Connect the -S terminals to the negative potential of the load.

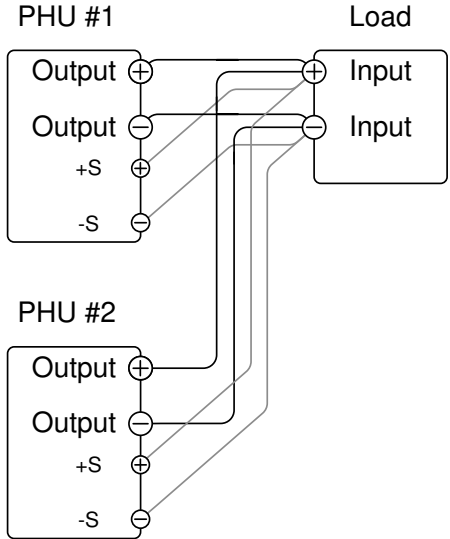

2. Operate the instrument as normal.
See the Parallel Operation chapter for details.

Wire Shielding and Load line impedance

To help to minimize the oscillation due to the inductance and capacitance of the load cables, use an electrolytic capacitor in parallel with the load terminals.

To minimize the effect of load line impedance use twisted wire pairing.

Shield the sense wires and connect the shield to the chassis ground.

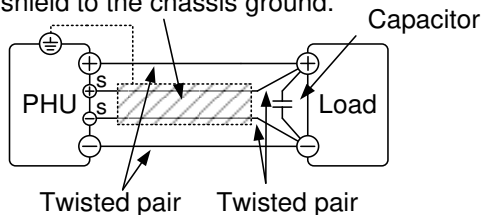

Parallel Operation

This section describes the basic operations required to operate the power supply in parallel. Operating the PHU series in parallel increases the total current output of the power supply units.

When the units are used in parallel, a number of precautions and limitations apply. Please read the following sections before operating the power supplies in parallel.

- Master-slave parallel overview → from page 78
- Parallel connection → from page 81
- Parallel operation → from page 81

Master-Slave Parallel Overview

Background

When connecting the PHU power supplies in parallel, up to 10 units can be used, and all units must have the same output voltage for parallel operation.

To use the power supplies in parallel, units must be used in a “master-slave” configuration. In the master-slave configuration a “master” power supply controls any other connected “slave” power supplies. In order for the master unit to control the slave units, the master unit must use the parallel control connector and parallel/detecting port to control the slave units.

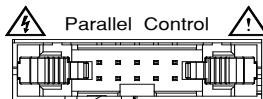
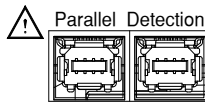

When using the parallel Control Connector, the connector must be wired correctly between the master and each of the slave units. (The following image is for reference.)

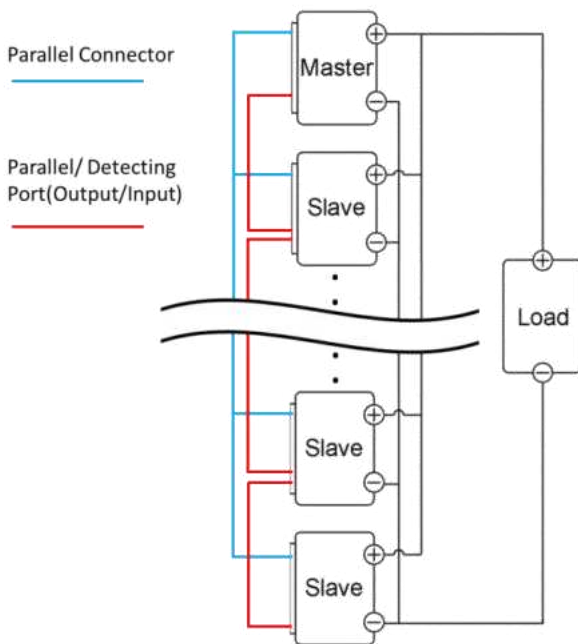

Limitations

Display

- Only the master unit will display the voltage and current.

OVP/OCP/OPP/UVL/OVL/UCL/OCL/OPL/ORL

- Slave units follow the settings of the master when
OVP/OCP/OPP/UVL/OVL/UCL/OCL/OPL/
ORL is tripped on the master unit.

Remote monitoring

- Voltage monitoring and current monitoring are only supported on the master unit.
- The IMON current represents the total current of the all the parallelized units.

Remote Sense

- Please see the remote sense chapter for details, page 74.

Parallel Calibration

- The parallel calibration function can be used to offset cables losses.

External Voltage and Resistance Control

- Voltage/Resistance controlled remote control can only be used with the master unit.
- The full scale current (in parallel) is equivalent to the maximum external voltage or resistance.

Internal Resistance

For 2 units in parallel, the internal resistance is actually half of the setting value.

For 3 units in parallel, the internal resistance is actually a third of the setting value.

For 4 units in parallel, the internal resistance is actually a fourth of the setting value, and so on.

Bleeder Control

- The Master unit is used to control the bleeder setting. The bleeder setting of slave unit is the same as standalone. Be careful of bleeder setting before setting in parallel.

Output Current	Model	1 unit	2 units	3 units	4 units
(For example, with four in parallel.)	PHU 80-170	170 A	340 A	510 A	680 A
	PHU 200-70	70 A	140 A	210 A	280 A
	PHU 500-30	30 A	60 A	90 A	120 A
	PHU 750-20	20 A	40 A	60 A	80 A
	PHU 1000-15	15 A	30 A	45 A	60 A
	PHU 1500-10	10 A	20 A	30 A	40 A
	PHU 80-340	340 A	680 A	1020 A	1360 A

PHU 200-140	140 A	280 A	420 A	560 A
PHU 500-60	60 A	60 A	60 A	60 A
PHU 750-40	40 A	80 A	120 A	160 A
PHU 1000-30	30 A	60 A	90 A	120 A
PHU 1500-20	20 A	40 A	60 A	80 A
PHU 80-510	510 A	1020 A	1530 A	2040 A
PHU 200-210	210 A	420 A	630 A	840 A
PHU 500-90	90 A	180 A	270 A	360 A
PHU 750-60	60 A	120A	180 A	240 A
PHU 1000-45	45 A	90 A	135 A	180 A
PHU 1500-30	30 A	60 A	90 A	120 A

Parallel Connection

Parallel Control Connection To operate the power supplies in parallel with the parallel connectors, connect the Parallel connectors on the master and slave units as shown in the diagrams below.

Parallel/Detecting port

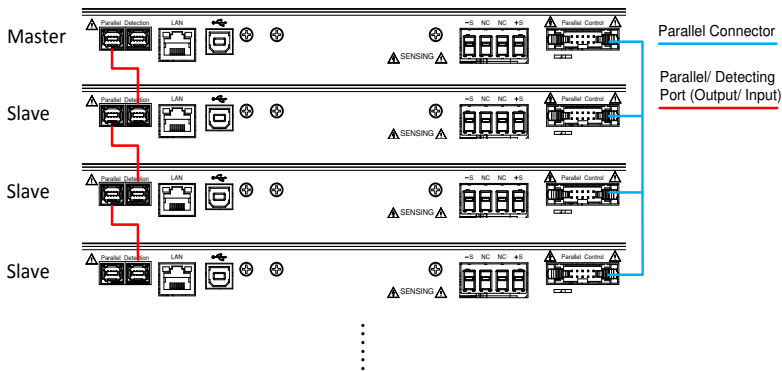

Parallel Operation

Master-Slave Configuration Before using the power supplies in parallel, the master and slave units need to be configured.

Steps

1. Configure the OVP, OCP, OPP, OVL, UCL, OCL, OPL, ORL and ULV settings for the master unit.
2. For each unit, enter the menu, and choose the Configuration icon.

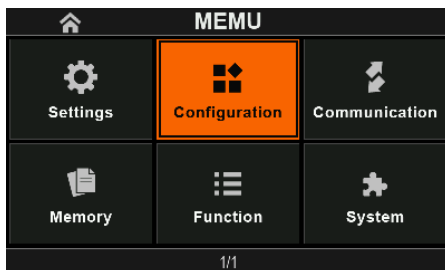

3. Choose the "Master-slave" icon in the Configuration page.

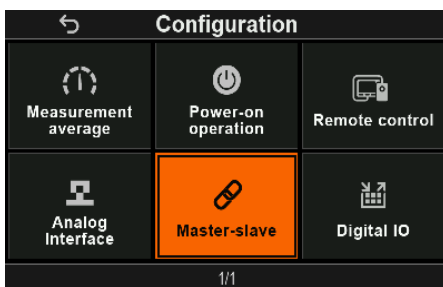

4. Users can set for each master/slave unit.



Single: The unit does not use parallel connection. (Default).



Master: The user can set the total power of up to 150 kW.



Slave: The user can set Slave units numbered from 1 to 10.



Configuration settings can be checked on both the master and slave units.

Only the Master OVP, OCP, OPP, OVL, UCL, OCL, OPL, ORL, ULV settings are used for protection. Slave protection levels are disregarded.

Master-Slave Operation

Only operate the power supplies in parallel if the units are configured correctly.

Steps

5. Turn on the master and slave units. The slave unit(s) will show a "Slave" display.

Master unit



Slave units



6. Operation of all units is controlled via the master unit. Operation of the master unit is the same as for a single unit. See the Configuration chapter. Page 102
7. Press the Output key to begin. The output LED will become lit.

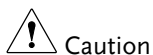

Caution

Only operate the power supplies in parallel if using units of the same model number.



Note

The panel controls are disabled on slave units, including the output key. On slave units, only the menu key can be used to view the current settings.

Sequence (Test Scripts)

This section describes how to use the Sequence function to run, load and save test scripts for automated testing. The Sequence function is useful if you want to perform a number of tests automatically. The PHU sequence function can store ten Sequence in memory.

Each test script is programmed in a scripting language. For more information on how to create test scripts, please contact GW Instek.

- Sequence file format → from page 86
- Sequence settings → from page 86
- Import Sequenced from USB → from page 87
- Run Sequence → from page 90
- Export Sequence to USB → from page 92
- Delete Sequence → from page 94
- Edit Sequence → from page 95

Sequence File Format

Background The test files are saved in *.csv file format.
Each file is saved as tXXX.csv, where XXX is the save file number 001~010.

Sequence Settings

Sequence Run A script must first be imported from the USB before it can be run. Refer to the function 'Sequence Import' below. After importing the test scripts, load the chosen script. The PHU display will switch to the Sequence type. Press the Output button on the front panel, and the script will run as soon as the Sequence function is started.

Sequence Import Copies a sequence from the USB drive to the designated save slot in memory. A script must first be copied into internal memory before it can be run.

(USB→PHU)

Sequence Export Exports a script from the designated memory save slot to the USB drive.

(PHU→USB)

Sequence Delete Deletes the chosen test file from the PHU internal memory.

Sequence Edit Edit the testing steps in sequence.

Import Sequence from USB

- Overview** Before a Sequence can be run, it must first be loaded into one of the 10 memory save slots. Before loading a Sequence into memory:
- Ensure the script file is placed in the root directory.
 - Ensure the file name number corresponds to the memory number that you wish to save to. For example t001.csv can only be loaded into memory number #01, t002.csv into memory number #02, and so on.

- Steps**
1. Insert a USB flash drive into the front panel USB-A slot. Ensure the flash drive contains a Sequence in the root directory.
 2. Press the Menu button and choose the “Function” icon.

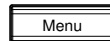

3. Choose the “Sequence” icon in the Function page.



4. Choose the “Import from USB” icon in the Sequence page.



5. Choose the Sequence





Note

Example: The CSV file format of PSW for SAS. (PHU supports this format)

	A	B	C	D	E	F	G	H	I	J	K	L	M
1	name	SAS Example.											
2													
3	Expier/Name	VI											
4	Circle/Name	Number	Start Step	End Step									
5	Circle	2	3	8									
6													
7	Pages	SAS											
8													
9	Step	Print	Output	Time(sec)	Voc(V)	Vmax(V)	In(A)	In(A)	CV(%)	OC(%)	IV(%)	Max(%)	
10	1	On	On	10	40	32	10	9	MAX	MAX	CVHS	0	
11	2	On	On	10									
12	3	On	On	10									
13	4	On	On	10	40	32	7	6.3					
14	5	On	On	10									
15	6	On	On	10									
16	7	On	On	10	30	24	10	9					
17	8	On	On	10									
18	9	On	On	10									
19	10	On	On	10									

Run Sequence

Overview

A Sequence can be run from one of ten memory slots.

Steps

1. Before a test script can be run, it must first be loaded into one of the 10 memory save slots.
2. Configure SEQ to 1 to 10 (save memory slot no. to run)

Range SEQ 1 to 10

3. Press the Menu key to go to the Sequence page. Choose the “Load” icon in this page.

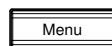

- Users can choose the Sequence that they want to load. (In SEQ1 to SEQ10, the icon next to "File" indicates that there is data. If the icon is not present, it means there is no data.)



- The Sequence type will be displayed when completed. At this point, the bottom left corner of the screen will change to the appearance shown in the image. (The image is for reference.)

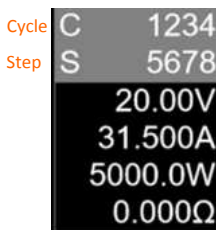

- Press the Output button on the front panel, and the Sequence will automatically start to run.



Note

Error messages: If you try to run a Sequence from an empty memory location, a window will pop up at this time to remind "no data".

Stop a Sequence

To stop (abort) a running Sequence at any time, press the Output button on the front panel. Users can press the ESC button to exit Sequence type and the display will return to the Load SEQ page.

Export Sequence to USB

Overview

The Export Sequence function saves a test file to the root directory of a USB flash drive.

- Files will be saved as tXXX.tst where XXX is the memory number 001~010 from which the SEQ was exported from.
- Files of the same name on the USB flash drive will be written over.

Steps

1. Insert a USB flash drive into the front panel USB-A slot. 



2. Press the Menu button and choose the “Function” icon.

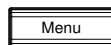

3. Choose the “Sequence” icon in the Function page.



4. Choose the “Export to USB” icon in the Sequence page.



Caution

If the USB drive is not recognized, check to see the block of interface state. If not, reinsert the USB flash drive. (The image is for reference.)



Delete Sequence

Overview The Delete Sequence function will delete a SEQ from the internal memory.

- Steps**
1. Choose the “Delete” icon in the Sequence page to remove from the internal memory.



2. Choose the SEQ that you want to remove. The SEQ will be removed from the internal memory.



Caution

Error messages: If you try to remove a SEQ from an empty memory location, a window will pop up at this time to remind “no data”.

Edit Sequence

Overview The user can use the “Edit Sequence” function to set the step parameters.

Steps

1. Press the Menu button and choose the “Function” icon.

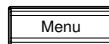

2. Choose the “Sequence” icon in the Function page.



3. Choose the “Edit” icon in the Sequence page.

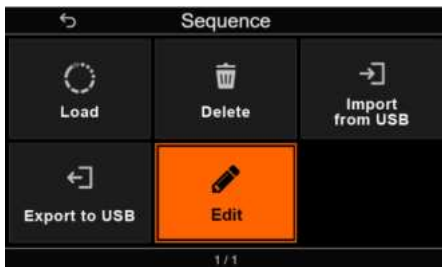

4. For example, choose the "SEQ1" in "Edit SEQ" page.



5. In the "Edit SEQ1" page, use the Current Knob to move the Step cursor (blue box). Use the Voltage Knob to move the function options (orange), such as [Cycle] <=> [Save] <=> [Edit] <=> [Insert] <=> [Delete].

The screenshot shows the 'Edit SEQ1' screen with a table of sequence steps. The 'Cycle' option is highlighted in orange. The table has columns for Step, Time (s), Voltage (V), Current (A), and Power (W). The 'Save', 'Edit', 'Insert', and 'Delete' options are at the bottom.

Step	Time (s)	Voltage (V)	Current (A)	Power (W)
1	1728000.0	1.23	10.987	5100.0
2	0.5	10.00	0.001	5100.0
3	60.0	12.34	1.000	5100.0
4	1234567.8	1.00	2.000	5100.0
5	0.1	2.00	3.456	5100.0
6	12.3	3.00	5.678	5100.0

Function options: Save, Edit, Insert, Delete. A '1 / 1' indicator is at the bottom.

6. Press the Current Knob to bring up the "Jump to Step" dialog box, allowing you to immediately jump to the entered Step.

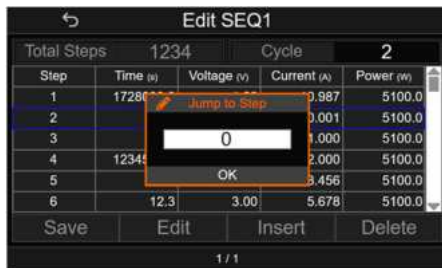

- In the “Jump to Step” dialog box, pressing the Voltage Knob will directly jump to “Edit”.



- In the “Edit SEQ1” menu, rotate the Voltage Knob to “Save” and press the Voltage Knob.



- The message box “Access ...” will appear, analyzing the entire sequence process. Since the editing is done locally, it only needs to check if “Loop” and “Endloop” are paired correctly and ensure there are no recursions. If everything is correct, the data will be saved, and the message box will close.



10. If “Loop” and “Endloop” are not paired correctly or if there is recursion, a dialog box will be displayed.



11. In the “Edit SEQ1” menu, rotate the Voltage Knob to “Edit” and press the Voltage Knob. This will enter the “Edit SEQ1 / Step1” first page setting menu.



Output: Control “Output OFF” and “Output ON”.



Output Mode: When Output ON, output with

“CV priority” or “CC priority”.



Time (sec): Set the duration for this step to execute, ranging from 0.05 seconds to 20 days. Setting it to 0 means infinite (displayed as INFINITY).



Trig Out: Set whether to generate a Trig Out signal; the output IO pin can be defined in the Digital IO settings.



Operation and Parameter: Special function operation.

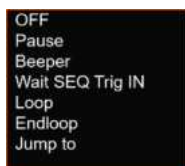

- Pause:
The sequence pauses until the “Current” button is pressed or the “continue” command is received.
- Beeper:
The buzzer sounds. In the Parameter, 0 means OFF, and 1 means ON.
- Wait SEQ Trig IN:
Waits until the “SEQ Trig IN” signal is received from the Digital I/O.
- Loop:
Starts a loop, used in conjunction with Endloop. The Parameter specifies the number of loop iterations.
- Endloop:
Ends the loop, used in

conjunction with Loop.

- Jump to:
Jumps to a specified Step. The Parameter is the target Step.

12. When the Voltage Knob is rotated to “Parameter” and then turned clockwise, it will enter the “Edit SEQ1/ Step1” second page setting menu.



Voltage: Set the voltage value.

Current: Set the current value.

Power: Set the power value.

Resistance: Set the internal resistance value.

Bleeder: Set the Bleeder resistor control method.



Ramp: Set whether the transition from the previous step to the next step is immediate or with a slope.



Prev Step: Switch to the previous step.

Next Step: Switch to the next step.

13. When the Voltage Knob is rotated to “Ramp” and then rotated clockwise, it will enter the menu “Edit SEQ1/Step1” on the third-page settings.



OVP: Set the over-voltage protection value.

OCP: Set the over-current protection value.

C ONFIGURATION

Menu Overview.....	103
Menu Table	106
Additional information	117
Digital I/O Configuration.....	119

Menu Overview

Menu of the PHU power supplies is divided into six different settings: Settings, Configuration, Communication, Memory, Function, and System.

The settings can be changed when the unit is already on. This prevents some important configuration parameters from being changed inadvertently. Here is the menu tree below.

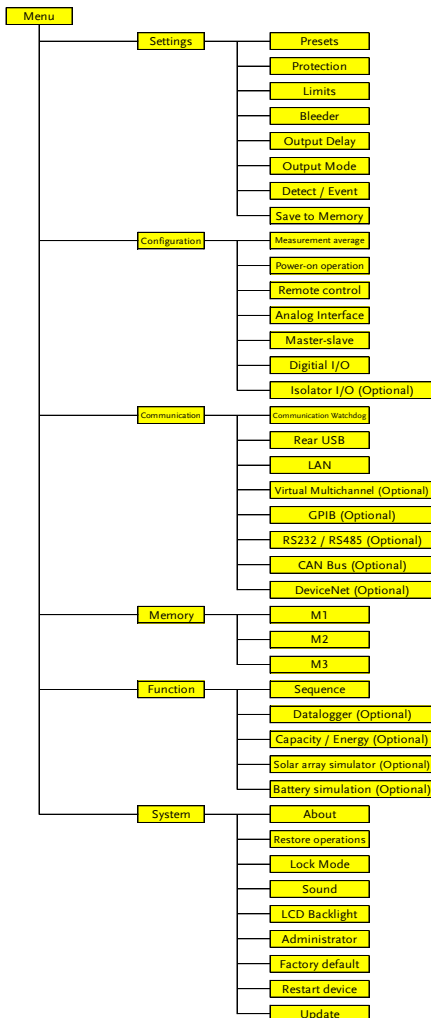

1st	2nd	3rd
Settings	Presets	Vset, Iset, Pset, Rset
	Protection	OVP OVP Delay, OCP OCP Delay, OPP OPP Delay
	Limits	UVL, OVL, UCL, OCL, OP, ORL
	Bleeder	ON, OFF, Auto
	Output Delay	ON delay time, OFF delay time
	Output Mode	CVHS, CVLS, CCHS, CCLS, VSR, ISR
	Detect/Event	UVD, OVD, UCD, OCD, OPD
	Save to Memory	M1, M2, M3
Configuration	Measurement average	Low, Middle, High
	Power-on operation	Display, Output rate, Memory
	Remote control	Not allowed, Allows
	Analog Interface	V-control, I-control, P-control, R-control, REM-OUT control
	Master-slave	Single, Master, Slave
	Digital I/O	Default, View, Function, Polarity
	Isolator I/O(Optional)	
Communication	Communication	
	Watchdog	
	Rear USB	CDC, TMC
	LAN	IP, MAC, Web, Port, TCP
	Virtual Multichannel (Optional)	Domain number, Channel number
	GPIB (Optional)	Address
	RS232/485 (Optional)	Baud rate, RS485 Address
	CAN Bus (Optional)	Baud rate, Node Address
	DeviceNet (Optional)	Baud rate, MAC ID

1st	2nd	3rd
Memory	M1	View, Load, Import, Export
	M2	View, Load, Import, Export
	M3	View, Load, Import, Export
Function	Sequence	Load, Delete, Import, Export, Edit
	Datalogger (Optional)	
	Capacity/ Energy (Optional)	
	Solar array simulator (Optional) Battery Simulation (Optional)	
System	About	Model, SN, OS version, SW version, FW version
	Restore operations	Safe, Auto
	Lock Mode	Allow output off or Allow output on/off
	Sound	Key sound, Alarm sound
	LCD Backlight	Deactivated, Activates, Brightness adjust
	Administrator	
	Factory default	
	Restart device	
Update		

Steps

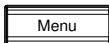
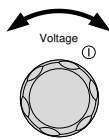
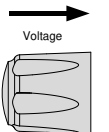
1. Press the “Menu” button on the panel. 
2. Rotate the voltage knob to choose which setting you want to set. 
3. Press the voltage knob to enter the exclusive page. 

4. Among the parameters, some can be adjusted using the numeric keypad, while others are selected through the voltage knob.
5. Once the settings are complete, you can press the “ESC” key to return to the previous page.



(You can refer to page 56, where detailed examples are provided.)

Some functions and quick settings can be accessed through the buttons on the panel. For details, please refer to page 14. (Front Panel)

Menu Table

Please use the listed below when applying the various settings.

Settings	Path	Content/Setting Range
Internal resistance setting	Menu/ Setting/ Presets	(0.000 to 0.471) Ω(PHU 80-170)
		(0.000 to 2.857) Ω(PHU 200-70)
		(0.00 to 16.67) Ω(PHU 500-30)
		(0.00 to 37.50) Ω(PHU 750-20)
		(0.0 to 66.7) Ω(PHU 1000-15)
		(0.0 to 150.0) Ω(PHU 1500-10)
		(0.000 to 0.235) Ω(PHU 80-340)
		(0.000 to 1.428) Ω(PHU 200-140)
		(0.00 to 8.33) Ω(PHU 500-60)
		(0.00 to 18.75) Ω(PHU 750-40)
		(0.00 to 33.33) Ω(PHU 1000-30)
		(0.0 to 75.0) Ω(PHU 1500-20)
		(0.000 to 0.157) Ω(PHU 80-510)
		(0.00 to 0.95) Ω(PHU 200-210)
(0.00 to 5.56) Ω(PHU 500-90)		
(0.00 to 12.50) Ω(PHU 750-60)		
(0.00 to 22.22) Ω(PHU 1000-45)		
(0.0 to 50.0) Ω(PHU 1500-30)		
OVP,OPP,OVP	Menu/ Settings/ Protection	Refer to page 56

OVP Delay Time	Menu/ Settings/ Protection	0.1 sec to 2.0 sec(PHU 80-170, 200-70, 500-30) 0.0 sec to 2.0 sec(other series)
OCP Delay Time	Menu/ Settings/ Protection	0.1 sec to 2.0 sec
OPP Delay Time	Menu/ Settings/ Protection	0.1 sec to 2.0 sec
Voltage Setting Limit (UVL & OVL)	Menu/ Settings/ Limits	(0.00 to 84.00) V(PHU 80-170)
		(0.00 to 210.00) V(PHU 200-70)
		(0.00 to 525.00) V(PHU 500-30)
		(0.0 to 787.5) V(PHU 750-20)
		(0.0 to 1050.0) V(PHU 1000-15)
		(0.0 to 1575.0) V(PHU 1500-10)
		(0.00 to 84.00) V(PHU 80-340)
		(0.00 to 210.00) V(PHU 200-140)
		(0.00 to 525.00) V(PHU 500-60)
		(0.0 to 787.5) V(PHU 750-40)
		(0.0 to 1050.0) V(PHU 1000-30)
		(0.0 to 1575.0) V(PHU 1500-20)
		(0.00 to 84.00) V(PHU 80-510)
		(0.00 to 210.00) V(PHU 200-210)
(0.00 to 525.00) V(PHU 500-90)		
Current Setting Limit (UCL & OCL)	Menu/ Settings/ Limits	(0.00 to 178.50) A(PHU 80-170)
		(0.00 to 73.50) A(PHU 200-70)
		(0.000 to 31.500) A(PHU 500-30)
		(0.000 to 21.000) A(PHU 750-20)
		(0.000 to 15.750) A(PHU 1000-15)
		(0.000 to 10.500) A(PHU 1500-10)
		(0.00 to 357.00) A(PHU 80-340)
		(0.00 to 147.00) A(PHU 200-140)
		(0.00 to 63.30) A(PHU 500-60)
		(0.000 to 42.000) A(PHU 750-40)
		(0.000 to 31.500) A(PHU 1000-30)
		(0.000 to 21.000) A(PHU 1500-20)
		(0.00 to 535.50) A(PHU 80-510)
		(0.00 to 220.50) A(PHU 200-210)
(0.00 to 94.50) A(PHU 500-90)		

	(0.00 to 63.00) A(PHU 750-60)
	(0.000 to 47.250) A(PHU 1000-45)
	(0.000 to 31.500) A(PHU 1500-30)

Power Setting Limit (OPL)	Menu/ Settings/ Limits	(0 to 5100) W(PHU 80-170)
		(0 to 5100) W(PHU 200-70)
		(0 to 5100) W(PHU 500-30)
		(0 to 5100) W(PHU 750-20)
		(0 to 5100) W(PHU 1000-15)
		(0 to 5100) W(PHU 1500-10)
		(0 to 10200) W(PHU 80-340)
		(0 to 10200) W(PHU 200-140)
		(0 to 10200) W(PHU 500-60)
		(0 to 10200) W(PHU 750-40)
		(0 to 10200) W(PHU 1000-30)
		(0 to 10200) W(PHU 1500-20)
		(0 to 15300) W(PHU 80-510)
		(0 to 15300) W(PHU 200-210)
		(0 to 15300) W(PHU 500-90)
		(0 to 15300) W(PHU 750-60)
(0 to 15300) W(PHU 1000-45)		
(0 to 15300) W(PHU 1500-30)		

Resistance Setting Limit(ORL)	Menu/ Settings/ Limits	(0 to 0.4706) Ω (PHU 80-170)
		(0 to 2.8571) Ω (PHU 200-70)
		(0 to 16.667) Ω (PHU 500-30)
		(0 to 37.5) Ω (PHU 750-20)
		(0 to 66.6667) Ω (PHU 1000-15)
		(0 to 150) Ω (PHU 1500-10)
		(0 to 0.2352) Ω (PHU 80-340)
		(0 to 1.4286) Ω (PHU 200-140)
		(0 to 8.3333) Ω (PHU 500-60)
		(0 to 18.75) Ω (PHU 750-40)
		(0 to 33.3333) Ω (PHU 1000-30)
		(0 to 75) Ω (PHU 1500-20)
		(0 to 0.1569) Ω (PHU 80-510)
		(0 to 0.9524) Ω (PHU 200-210)
		(0 to 5.5556) Ω (PHU 500-90)
		(0 to 12.5) Ω (PHU 750-60)
(0 to 22.2222) Ω (PHU 1000-45)		
(0 to 50) Ω (PHU 1500-30)		

Bleeder circuit control	Menu/ Setting/ Bleeder	ON/OFF/AUTO (Page 63)
Output ON delay time	Menu/ Setting/ Output Delay	Delays turning the output on for a designated amount of time. 0.00 sec to 99.99 sec
Output OFF delay time	Menu/ Setting/ Output Delay	Delays turning the output off for a designated amount of time. 0.00s to 99.99s
Output mode select	Menu/ Setting/ Output Mode	Selects High Speed Priority or Slew Rate Priority for CV or CC mode. The voltage or current slew rate can only be edited if CC/CV Slew Rate Priority is selected. CV high speed priority (CVHS) CC high speed priority (CCHS) CV slew rate priority (CVLS) CC slew rate priority (CCLS)
Rising/ Falling voltage slew rate	Menu/ Setting/ Output Mode	Sets the rising/Falling voltage slew rate. Only applicable if Output Mode is set to CV Slew Rate Priority. (0.01 to 160.00) V/sec (PHU 80-170) (0.01 to 400.00) V/sec (PHU 200-70) (0.1 to 1000.0) V/sec (PHU 500-30) (0.1 to 1500.0) V/sec (PHU 750-20) (0.1 to 2000.0) V/sec (PHU 1000-15) (0.1 to 3000.0) V/sec (PHU 1500-10) (0.01 to 160.0) V/sec (PHU 80-340) (0.01 to 400.00) V/sec (PHU 200-140) (0.1 to 1000.0) V/sec (PHU 500-60) (0.1 to 1500.0) V/sec (PHU 750-40) (0.1 to 2000.0) V/sec (PHU 1000-30) (0.1 to 3000.0) V/sec (PHU 1500-20) (0.01 to 160.0) V/sec (PHU 80-510) (0.01 to 400.00) V/sec (PHU 200-210) (0.1 to 1000.0) V/sec (PHU 500-90) (0.1 to 1500.0) V/sec (PHU 750-60)

		(0.1 to 2000.0) V/sec (PHU 1000-45) (0.1 to 3000.0) V/sec (PHU 1500-30)
Rising/Falling current slew rate	Menu/ Setting/ Output Mode	<p>Sets the rising/Falling current slew rate. Only applicable if Output Mode is set to CC Slew Rate Priority.</p> <p>(0.01 to 340.00) A/sec (PHU 80-170) (0.01 to 140.00) A/sec (PHU 200-70) (0.001 to 60.000) A/sec (PHU 500-30) (0.001 to 40.000) A/sec (PHU 750-20) (0.001 to 30.00) A/sec (PHU 1000-15) (0.001 to 20.00) A/sec (PHU 1500-10) (0.1 to 680.0) A/sec (PHU 80-340) (0.01 to 280.00) A/sec (PHU 200-140) (0.01 to 120.0) A/sec (PHU 500-60) (0.01 to 80.0) A/sec (PHU 750-40) (0.001 to 60.00) A/sec (PHU 1000-30) (0.001 to 40.00) A/sec (PHU 1500-20) (0.01 to 160.0) A/sec (PHU 80-510) (0.01 to 400.00) A/sec (PHU 200-210) (0.01 to 180.00) A/sec (PHU 500-90) (0.01 to 120.00) A/sec (PHU 750-60) (0.01 to 90.00) A/sec (PHU 1000-45) (0.001 to 60.00) A/sec (PHU 1500-30)</p>
Under voltage Detection	Menu/ Setting/ Detect/Event	<p>UVD Action:</p> <p>NONE/ SIGNAL/ (It will be displayed in the block of detect state when a UVD occurs) WARNING/ (When a UVD occurs, a window alert will appear).</p> <p>ALARM (When a UVD occurs, a window alert will appear, it will be displayed in the block of protection state, and the output will be automatically turned off.)</p>

Over voltage Detection	Menu/ Setting/ Detect/Event	<p>OVD Action:</p> <p>NONE/ SIGNAL/ (It will be displayed in the block of detect state when a OVD occurs)</p> <p>WARNING/ (When an OVD occurs, a window alert will appear).</p> <p>ALARM (When an OVD occurs, a window alert will appear, it will be displayed in the block of protection state, and the output will be automatically turned off.)</p>
Under current Detection	Menu/ Setting/ Detect/Event	<p>UCD Action:</p> <p>NONE/ SIGNAL/ (It will be displayed in the block of detect state when a UCD occurs)</p> <p>WARNING/ (When a UCD occurs, a window alert will appear).</p> <p>ALARM (When a UCD occurs, a window alert will appear, it will be displayed in the block of protection state, and the output will be automatically turned off).</p>
Over current Detection	Menu/ Setting/ Detect/ Event	<p>OCD Action:</p> <p>NONE/ SIGNAL/ (It will be displayed in the block of detect state when a OCD occurs)</p> <p>WARNING/</p>

		(When an OCD occurs, a window alert will appear).
		ALARM (When an OCD occurs, a window alert will appear, it will be displayed in the block of protection state, and the output will be automatically turned off).
		OPD Action: NONE/ SIGNAL/ (It will be displayed in the block of detect state when a OPD occurs)
Over power Detection	Menu/ Setting/ Detect/ Event	WARNING/ (When an OPD occurs, a window alert will appear). ALARM (When an OPD occurs, a window alert will appear, it will be displayed in the block of protection state, and the output will be automatically turned off).
Memory save	Menu/ Settings/ Save to memory	M1, M2, M3
Configuration	Path	Content/Setting Range
Measurement Average Setting	Menu/ configuration/ Measurement Average	Determines the level of smoothing for the average setting. Low/Middle/High
Specifies how the panel is displayed at power-on.	Menu/ Configuration/ Power-on Operation	Voltage Current Voltage Current Power Voltage Power Current Power Voltage Current Bar Voltage Current Power Bar

Configure the output state after power-on.	Menu/ Configuration/ Power-on Operation	Output is ON/OFF /LAST (LAST: The state when it was last turned off)
Configures the power supply to perform one of the following actions after power-on.	Menu/ Configuration/ Power-on Operation	None Load the M1/M2/M3 Load the SEQ1/2/3/4/5/6/7/8/9/10
Allows remote control of the device via digital or analog interface.	Menu/ Configuration/ Remote control	Not allowed/Allows
Analog interface	Menu/ Configuration/ Analog interface	voltage, current, power, resistance, REM-OUT control (Multiple choice)
Selects the voltage range for the analog set values, actual values and reference voltage output.	Menu/ Configuration/ Analog interface	0 V to 5 V/ 0 V to 10 V
Selects how the input pin REM-OUT of the analog interface shall be working regarding levels and logic.	Menu/ Configuration/ Analog interface	High ON/ Low ON
Master/Slave Configuration	Menu/ Configuration/M aster-Slave	single Master: total power Slave: address
Digital I/O	Menu/ Configuration/ Digital I/O	default, view, function, polarity (For detailed information, please refer to page 119)



Communication	Path	Content/Setting Range
watchdog	Menu/ Communication/ Communication Watchdog	During remote control, if there is no communication beyond the time set by the watchdog, an alarm will be issued and the output will be turned off. Range: 1 to 65535 Watchdog(s)/ WDOG protection
Setup rear USB	Menu/ Communication/ Rear USB	Device Mode: Disable, USB-CDC, USB-CDC (Full speed), USB-TMC
LAN: IP allocation Settings	Menu/ Communication/ LAN/ Edit	Manual, DHCP
LAN: IP address Settings	Menu/ Communication/ LAN/ Edit	(0 to 255). (0 to 255). (0 to 255). (0 to 255)
LAN: Gateway Settings	Menu/ Communication/ LAN/ Edit	(0 to 255). (0 to 255). (0 to 255). (0 to 255)
LAN: Subnet mask Settings	Menu/ Communication/ LAN/ Edit	(0 to 255). (0 to 255). (0 to 255). (0 to 255)
LAN: DNS Address Settings	Menu/ Communication/ LAN/ Edit	(0 to 255).(0 to 255).(0 to 255).(0 to 255)
LAN: Port Settings	Menu/ Communication/ LAN/ Edit	
LAN: Web control	Menu/ Communication/ LAN/ Edit	Enable, Disable
LAN: Host name Settings	Menu/ Communication/ LAN/ Edit	Users can use the virtual keyboard (use voltage knob to control)
LAN: Web password Settings	Menu/ Communication/ LAN/ Edit	Users can use the virtual keyboard (use voltage knob to control)

LAN: Domain name Settings	Menu/ Communication/ LAN/ Edit	Users can use the virtual keyboard (use voltage knob to control)
LAN: TCP keep-alive Settings	Menu/ Communication/ LAN/ Edit	Enable, Disable
Virtual Multichannel Settings(optional): Domain number Settings	Menu/ Communication/ Virtual Multichannel	0 The multichannel function is not used (factory default setting). 1 to 254 The domain number when the multichannel function is used.
Virtual Multichannel Settings(optional): Channel number Settings	Menu/ Communication/ Virtual Multichannel	0 Master unit on the multichannel network (factory default setting). 1 to 30 Channel number of the slave unit on the multichannel network.
GPIB (optional): Address Settings	Menu/ Communication/ GPIB	Address : 1 to 30
RS232/RS485 (optional): Baud rate Settings	Menu/ Communication/ RS232/RS485	2400, 4800, 9600, 19200, 38400, 57600, 115200
RS485 Address Settings(optional)	Menu/ Communication/ RS232/RS485	0 to 31
Can Bus (optional): Baud rate Settings	Menu/ Communication/ Can Bus	Auto, LSS, 10kbps, 20kbps, 50kbps, 100kbps, 125kbps, 250kbps, 500kbps, 800kbps, 1Mbps
Can Bus (optional): Node Address Settings	Menu/ Communication/ Can Bus	1 to 127
DeviceNet (optional): Baud rate Settings	Menu/ Communication/ DeviceNet	125kbps, 250kbps, 500kbps

DeviceNet (optional): MAC ID Settings	Menu/ Communication/ DeviceNet	0 to 63
Memory	Path	Content/Setting Range
Memory parameter (M1, M2, M3)	Menu/ Memory	View, Load, Import from USB, Export to USB
Function	Path	Content/Setting Range
Sequence	Menu/ Function/ Sequence	Load, Delete, Import from USB, Export to USB, Edit
System	Path	Content/Setting Range
About	Menu/ System/ About	Module, Serial Number, OS version, SW version, FW version
Action when recovering from AC-FAIL protection.	Menu/ System/ Restore operations	Safe: The alarm status is cleared after the problem that caused the alarm is fixed. Auto: The alarm status is cleared after the problem that caused the alarm is fixed, and returns to the status before the alarm occurs.
AC Power Recovery	Menu/ System/ Restore operations	The AC Power Recovery setting can only take effect when the device is disconnected to the power supply, the built-in power in the device has been completely released, and the device is reconnected to a power supply. Power OFF/ Power ON/ Last State/
Lock Mode	Menu/ System/ Lock Mode	When the front panel is locked, the Lock Mode function determines the behavior of the Output key. Allow output to turn off/ Allows to turn on/off output.

Buzzer ON/OFF control	Menu/ System/ Sound	Key sound:(Deactivates/activates) Alarm sound:(Deactivates/activates)
Backlight off after 60s	Menu/ System/ LCD Backlight	Deactivates/activates
Brightness adjust	Menu/ System/ LCD Backlight	(0 to 100) %
Administrator	Menu/ System/ Administrator	The device "Administrator" mode grants access to advanced settings and management features, password required.
Factory Default	Menu/ System/ Factory Default	ESC/ Reset
Reboots the instrument to its power-on state.	Menu/ System/ Restart Device	ESC/ Reset
Update	Menu/ System/ Update	

Additional information

 Note	The Output ON/OFF Delay Time setting has a maximum deviation (error) of 20 ms.
 Note	When the PHU DC OUTPUT is in progress, if the user presses the MENU button, they can view the configured parameters.
Rising/Falling Voltage Slew Rate	Sets the rising & falling voltage slew rate. Only applicable if Output Mode is set to CV Slew Rate Priority.
Rising/Falling Current Slew Rate	Sets the rising & falling current slew rate. Only applicable if Output Mode is set to CC Slew Rate Priority.
Internal Resistance Settings	Sets the internal resistance of the power supply. 0.000 Ω to X.XXX Ω (Where X.XXX = Rating Voltage/Rating Current)

Display Memory Parameter	Displays which memory setting is recalled (M1, M2 or M3) when recalling a setup.
--------------------------	--

Digital I/O Configuration

Introduction

The PHU's Digital I/O port includes a total of 7 input/output pins and one ground pin. These 7 pins can be individually configured as either inputs or outputs based on user settings. By default, these 7 pins are set to a static voltage of 5V output. When configured as inputs, the pins can be triggered by shorting them to ground. When configured as outputs, the voltage level of each pin will be either 5V or 0V (relative to ground), depending on the PHU's status. Additionally, the polarity (positive or negative) of these 7 pins can be adjusted through configuration settings.

Digital I/O interface

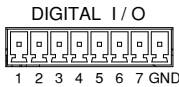

Panel operation

1. Press the menu button and enter the "Configuration" icon.

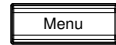

- Choose the “Digital IO” in the Configuration page.



- You can see there are four options in the Digital IO page.

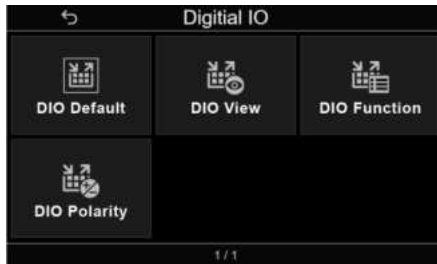

- Select **DIO Default** option to configure the DIO to the factory default settings.



5. Select **DIO View** option to see the DIO1 to DIO7 settings.



6. Select **DIO Function** option to set the DIO1 to DIO7 settings.



Input mode Output OFF, Output ON, Output Control, Clear Alarm, Load M1, Load M2, Load M3

Output mode Output State, Power ON, Power Fault , OVP, OCP, OPP, UVD, OVD, UCD, OCD, OPD, Alarm state

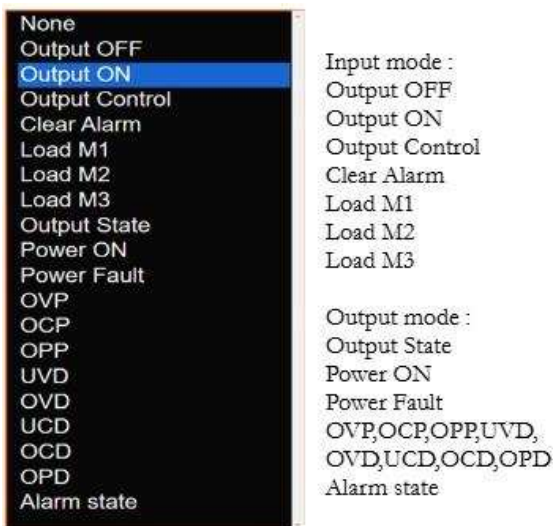

Alarm state PUF 1 to 6, FAN Fail 1 to 3, OTP, LLF, SLF, MSP

The Input mode is unique. For example, when DIO 1 is set to Output OFF, DIO 2 to DIO 6 cannot be set to Output OFF.

When the Output OFF signal is activated, the Output OFF signal takes priority over the Output ON signal, the Output Control signal, and the Output button operation on the front panel.

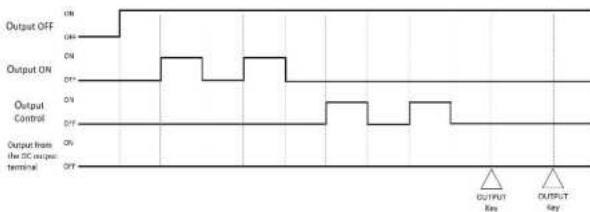

When the Output OFF signal is turned off, the relationship between the Output ON signal and the Output button operation is as follows.

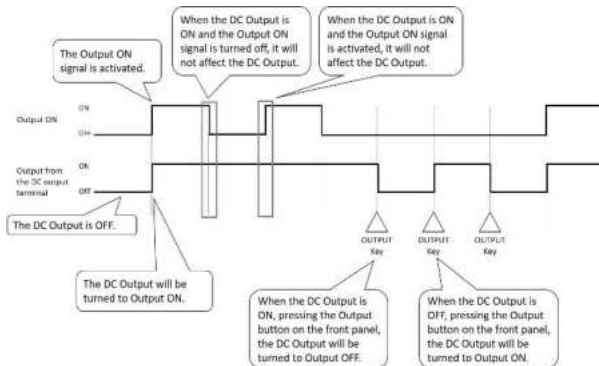

When the Output OFF signal is turned off, the relationship between the Output Control signal and the Output button operation is as follows.

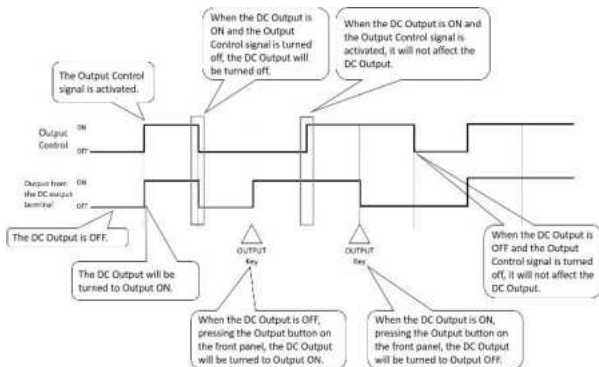

When the Output OFF signal is turned off, the relationship between the Output ON signal and the Output Control signal is as follows.

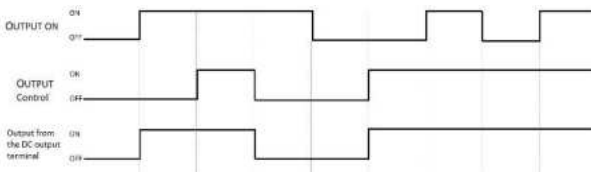

7. Select **DIO Polarity** option to set the Polarity of DIO 1 to DIO 7 as Positive or Negative. (Positive means a logical true signal is a voltage high at the pin. Negative means a logical true signal is a voltage low at the pin)



A ANALOG CONTROL

The Analog Control chapter describes how to control the voltage or current output using an external voltage or resistance, monitor the voltage or current output as well as remotely turning off the output or shutting down the power supply.

Analog Remote Control Overview	126
Analog Control Connector Overview	127
External Voltage Control of Voltage Output	132
External Voltage Control of Current Output	136
External Voltage Control of Power Output	140
External Voltage Control of Internal Resistance	144
External Resistance Control of Voltage Output	148
External Resistance Control of Current Output	152
External Resistance Control of Power Output	156
External Resistance Control of Internal Resistance Output ..	160
External Voltage Control of Output	164
External voltage control of Alarm input	168
Remote Monitoring.....	170
External Voltage, Current and Power Monitoring.....	170
External Operation and Status Monitoring.....	173

Analog Remote Control Overview

The PHU power supply series have a number of analog control options. The Analog Control connectors are used to control output voltage and current using external voltage or resistance. The power supply output can also be controlled using external switches.

There is also an isolated analog control option. The Isolated analog connector is used to control the output voltage and current using an isolated external voltage or current source. Like the analog connector, it can also be used to monitor the current and voltage output as well.

- Analog control connector overview → from page 127
- External voltage control of voltage output → from page 132
- External voltage control of current output → from page 136
- External voltage control of power output → from page 140
- External voltage control of internal resistance output → from page 144
- External Resistance Control of Voltage Output from page 148
- External Resistance Control of current Output from page 152
- External Resistance Control of power Output from page 156
- External Resistance Control of internal resistance Output from page 160
- External voltage control of output → from page 164
- External voltage control of Alarm input from page 168

Analog Control Connector Overview

Overview The Analog Control Connector is a 25 pin connector that can be used with the ARC (analog remote control) kit for wiring connections. The connector is used for all analog remote control. The pins used determine what remote control mode is used.

Pin Assignment

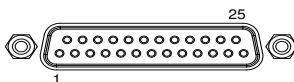

Pin name	Pin No.	Type & Description
EXT-V/R CV CONT	1	<p>Analog_IN:</p> <p>This line uses an external voltage or resistance to control the output voltage.</p> <p>0 V to 5 V or 0 V to 10 V; 0 % to 100 % of the rated output voltage.</p>
EXT-V/R CC CONT	2	<p>Analog_IN:</p> <p>This line uses an external voltage or resistance to control the output current.</p> <p>0 V to 5 V or 0 V to 10 V; 0 % to 100 % of the rated output current.</p>
EXT-V/R CP CONT	3	<p>Analog_IN:</p> <p>This line uses an external voltage or resistance to control the output power.</p> <p>0 V to 5 V or 0 V to 10 V; 0 % to 100 % of the rated output power.</p>

EXT-V/R IN_R 4 CONT	4	Analog_IN: This line uses an external voltage or resistance to control the internal resistance. 0 V to 5 V or 0 V to 10 V; 0 % to 100 % of the rated internal resistance.
VREF	5	Analog_OUT: This line provides 5V or 10V (depending on the setting) for use with external resistors.
AGND	6	Analog_GND: This is the common line for the external signal pins 1, 2, 3, 4, 5, 7, 8 and 9.
V_MON	7	Analog_OUT: Output voltage monitor. 0 % to 100 % of the rated output voltage is generated as a voltage between 0 V and 5 V or a voltage between 0 V and 10 V when the output is ON.
I_MON	8	Analog_OUT: Output current monitor. 0 % to 100 % of the rated output current is generated as a voltage between 0 V and 5 V or a voltage between 0 V and 10 V when the output is ON.
P_MON	9	Analog_OUT: Output power monitor. 0 % to 100 % of the rated output power is generated as a voltage between 0 V and 5 V or a voltage between 0 V and 10 V when the output is ON.
AGND	10	Analog_GND: This is the common line for the external signal pins 1, 2, 3, 4, 5, 7, 8 and 9.

ALM CLEAR	11	Digital_IN: Alarm clear line. Alarms are cleared when a high level (+4.5 V to +5 V) signal is applied.
Alarm Input	12	Digital_IN: The output is turned off when a high level (+4.5 V to +5 V) signal is applied.
OUT ON/OFF CONT	13	Digital_IN: When set to High = On, the output is turned on when input 5 V, the output is turned off when input 0 V. When Low = On, the output is turned on when input 0 V, the output is turned off when input 5 V.
ANALOG ENAB	14	Digital_IN: Analog function enables line. The Analog function is enable when a high level (+4.5 V to +5 V) signal is applied.
STATUS COM	15	Digital_GND: This is the common line for the external signal pins 11, 12, 13, 14, 17, 18, 19, 20, 21 and 22.
STATUS COM	16	Digital_GND: This is the common line for the external signal pins 11, 12, 13, 14, 17, 18, 19, 20, 21 and 22.
OUT ON STATUS	17	Digital_OUT: On when the output is on (open collector photocoupler output)*1
PWR ON STATUS	18	Digital_OUT: Outputs a low level signal when power is turned on. (open collector photocoupler output)*1

ALM STATUS	19	Digital_OUT: On when a protection function has been activated or when an output shutdown signal is being applied (open collector photocoupler output) *1
CV STATUS	20	Digital_OUT: This line is on when the PHU is in CV mode (photocoupler open collector output)*1.
CC STATUS	21	Digital_OUT: This line is on when the PHU is in CC mode (photocoupler open collector output)*1.
CP STATUS	22	Digital_OUT: This line is on when the PHU is in CP mode (photocoupler open collector output)*1.
STATUS COM	23	Digital_GND: This is the common line for the external signal pins 11, 12, 13, 14, 17, 18, 19, 20, 21 and 22.
AGND	24	Analog_GND: This is the common line for the external signal pins 1, 2, 3, 4, 5, 7, 8 and 9.
AGND	25	Analog_GND: This is the common line for the external signal pins 1, 2, 3, 4, 5, 7, 8 and 9.
	Note*1	Open collector output: 30V max, 8mA max The common line for the status pins is floating (isolated voltage of 60 V or less). It is isolated from the control circuit.

**Note**

The PIN14 is the Analog function enable line. When users using external signals to control the output parameters of the PHU, They needs to provide a high level voltage(+4.5 V to +5 V) at PIN14, relative to Digital_ GND (PIN15, PIN16, PIN23). Otherwise, the external control functionality will not be available.

External Voltage Control of Voltage Output

Background External voltage control of the voltage output is accomplished using the analog control connector on the rear panel. There are two external voltage control ranges, (0 to 5) V and (0 to 10) V, depending on the configuration.

For 0 V to 10 V:

Output voltage = full scale voltage x (external voltage/10)

For 0 V to 5 V:

Output voltage = full scale voltage x (external voltage/5)

(Setting Path: Menu/Configuration/ Analog interface/page2)

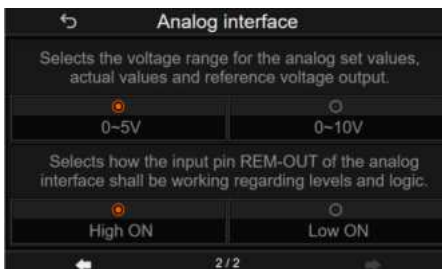

Connection When connecting the external voltage source to the analog connector, use shielded or twisted paired wiring.

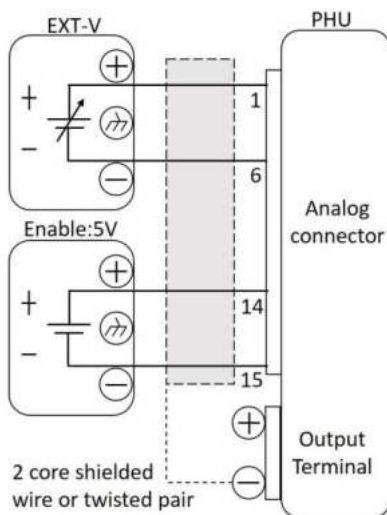

- Pin1 → EXT-V (+)
- Pin6 or Pin10 or Pin24 or Pin25 → EXT-V (-)
- Pin14 → Enable (+)
- Pin15 or Pin16 or Pin23 → Enable (-)
- Wire shield → negative (-) output terminal

Connection- alt. shielding

If the wire shield needs to be grounded at the voltage source (EXT-V), then the shield cannot also be grounded at the negative (-) terminal output of the PHU power supply. This would short the output.

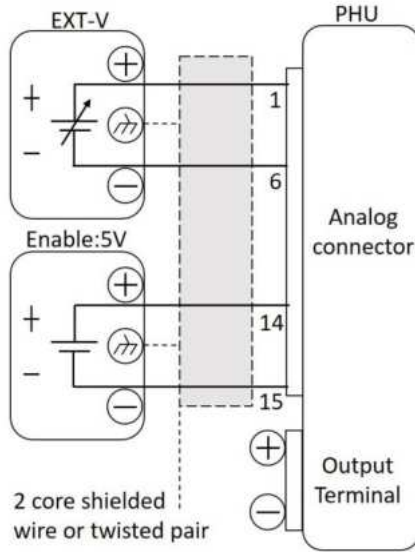

- Pin1 → EXT-V (+)
- Pin6 or Pin10 or Pin24 or Pin25 → EXT-V (-)
- Pin14 → Enable (+)
- Pin15 or Pin16 or Pin23 → Enable (-)
- Wire shield → EXT-V ground (GND)

Panel operation

1. Connect the external voltage according to the connection diagrams above.

- Press the menu button and enter the “Configuration” icon.



- Choose the “Analog interface” in the Configuration page.



- Check “Voltage control”.



Note

Use a stable voltage supply for the external voltage control.



CAUTION

Ensure no more than 10.5 volts or 5.25 volts are input into the external voltage input.

Ensure the voltage polarity is correct when connecting the external voltage.

External Voltage Control of Current Output

Background External voltage control of the current output is accomplished using the analog control connector on the rear panel. There are two external voltage control ranges, 0 V to 5 V and 0 V to 10V, depending on the configuration.

For 0 V to 10 V:

Output current = full scale current x (external voltage/10)

For 0 V to 5 V:

Output current = full scale current x (external voltage/5)

(Setting Path: Menu/Configuration/ Analog interface/page2)

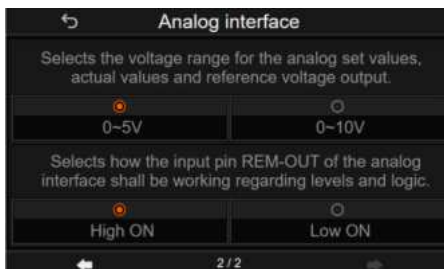

Connection When connecting the external voltage source to the connectors, use shielded or twisted paired wiring.

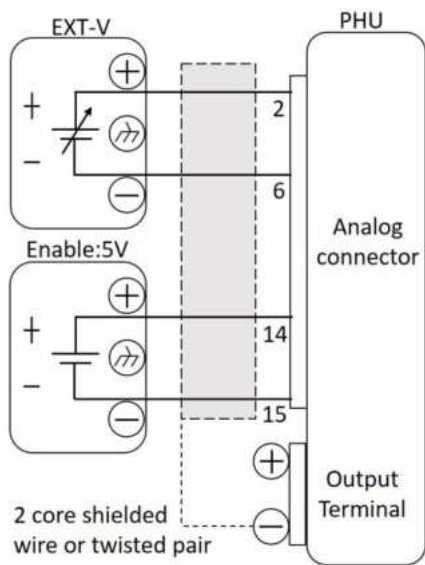

- Pin2 → EXT-V (+)
- Pin6 or Pin10 or Pin24 or Pin25 → EXT-V (-)
- Pin14 → Enable (+)
- Pin15 or Pin16 or Pin23 → Enable (-)
- Wire shield → negative (-) output terminal

Connection- alt. shielding If the wire shield needs to be grounded at the voltage source (EXT-V), then the shield cannot also be grounded at the negative (-) terminal output of the PHU power supply. This would short the output.

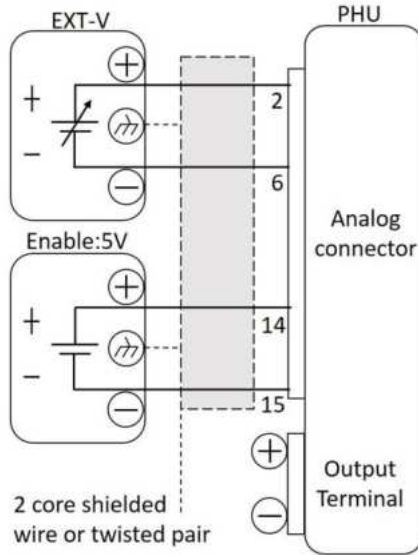

- Pin2 → EXT-V (+)
- Pin6 or Pin10 or Pin24 or Pin25 → EXT-V (-)
- Pin14 → Enable (+)
- Pin15 or Pin16 or Pin23 → Enable (-)
- Wire shield → EXT-V ground (GND)

Panel operation 1. Connect the external voltage according to the connection diagrams above.

2. Press the menu button and enter the “Configuration” icon.



3. Choose the “Analog interface” in the Configuration page.

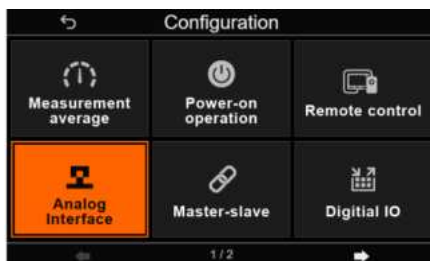

4. Check “Current control”.



Note

Use a stable voltage supply for the external voltage control.



CAUTION

Ensure the voltage polarity is correct when connecting the external voltage.

Ensure no more than 10.5 volts or 5.25 volts are input into the external voltage input.

External Voltage Control of Power Output

Background External voltage control of the power output is accomplished using the analog control connector on the rear panel. There are two external voltage control ranges, 0 V to 5 V and 0 V to 10V, depending on the configuration.

For 0 V to 10 V:

Output power = full scale power x (external voltage/10)

For 0 V to 5 V:

Output power = full scale power x (external voltage/5)

(Setting Path: Menu/Configuration/ Analog interface/page2)

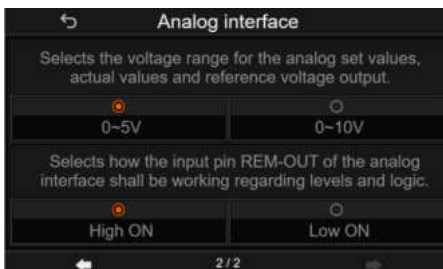

Connection When connecting the external voltage source to the connectors, use shielded or twisted paired wiring.

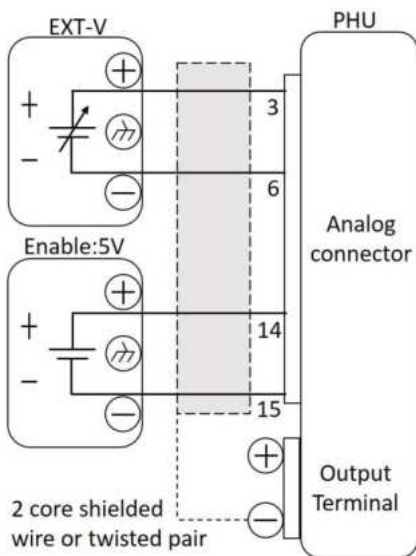

- Pin3 → EXT-V (+)
- Pin6 or Pin10 or Pin24 or Pin25 → EXT-V (-)
- Pin14 → Enable (+)
- Pin15 or Pin16 or Pin23 → Enable (-)
- Wire shield → negative (-) output terminal

Connection- alt. shielding If the wire shield needs to be grounded at the voltage source (EXT-V), then the shield cannot also be grounded at the negative (-) terminal output of the PHU power supply. This would short the output.

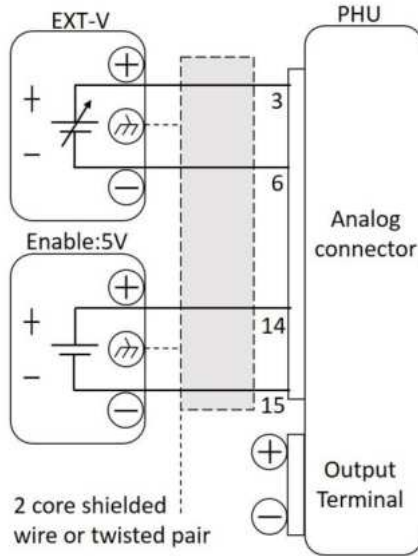

- Pin3 → EXT-V (+)
- Pin6 or Pin10 or Pin24 or Pin25 → EXT-V (-)
- Pin14 → Enable (+)
- Pin15 or Pin16 or Pin23 → Enable (-)
- Wire shield → EXT-V ground (GND)

Panel operation 1. Connect the external voltage according to the connection diagrams above.

2. Press the menu button and enter the “Configuration” icon.



3. Choose the “Analog interface” in the Configuration page.



4. Check “Power control”.



Note

Use a stable voltage supply for the external voltage control.



CAUTION

Ensure the voltage polarity is correct when connecting the external voltage.

Ensure no more than 10.5 volts or 5.25 volts are input into the external voltage input.

External Voltage Control of Internal Resistance

Background External voltage control of the Internal Resistance is accomplished using the analog control connector on the rear panel. There are two external voltage control ranges, 0 V to 5 V and 0 V to 10V, depending on the configuration.

For 0 V to 10 V:

Output Resistance = full scale Resistance x
(external voltage/10)

For 0 V to 5 V:

Output Resistance = full scale Resistance x
(external voltage/5)

(Setting Path: Menu/Configuration/ Analog interface/page2)

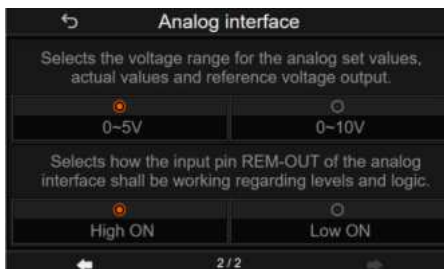

Connection When connecting the external voltage source to the connectors, use shielded or twisted paired wiring.

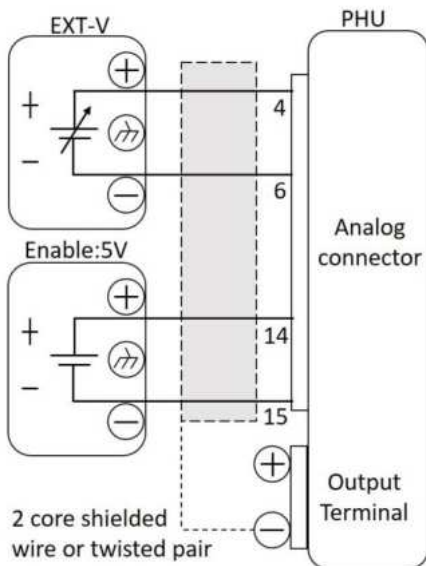

- Pin4 → EXT-V (+)
- Pin6 or Pin10 or Pin24 or Pin25 → EXT-V (-)
- Pin14 → Enable (+)
- Pin15 or Pin16 or Pin23 → Enable (-)
- Wire shield → negative (-) output terminal

Connection- alt. shielding If the wire shield needs to be grounded at the voltage source (EXT-V), then the shield cannot also be grounded at the negative (-) terminal output of the PHU power supply. This would short the output.

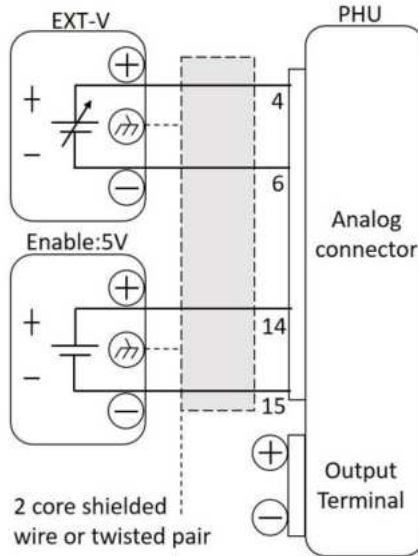

- Pin4 → EXT-V (+)
- Pin6 or Pin10 or Pin24 or Pin25 → EXT-V (-)
- Pin14 → Enable (+)
- Pin15 or Pin16 or Pin23 → Enable (-)
- Wire shield → EXT-V ground (GND)

Panel operation 1. Connect the external voltage according to the connection diagrams above.

2. Press the menu button and enter the “Configuration” icon.



3. Choose the “Analog interface” in the Configuration page.

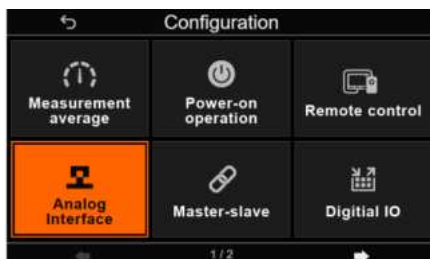

4. Check “Resistance control”.



Note

Use a stable voltage supply for the external voltage control.



CAUTION

Ensure the voltage polarity is correct when connecting the external voltage.

Ensure no more than 10.5 volts or 5.25 volts are input into the external voltage input.

External Resistance Control of Voltage Output

Background External Resistance control of the voltage output is accomplished using the analog control connector on the rear panel. There are two external voltage control ranges, 0 V to 5 V and 0 V to 10V, depending on the configuration.

For 0 V to 10 V:

Output power = full scale power x (external voltage/10)

PIN 5 (VREF) will output 10V.

For 0 V to 5 V:

Output power = full scale power x (external voltage/5)

PIN 5 (VREF) will output 5V.

(Setting Path: Menu/Configuration/ Analog interface/page2)

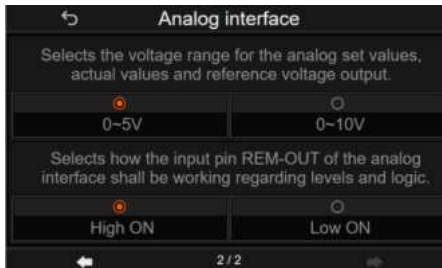

Connection When connecting the external resistance to the connectors, use shielded or twisted paired wiring.

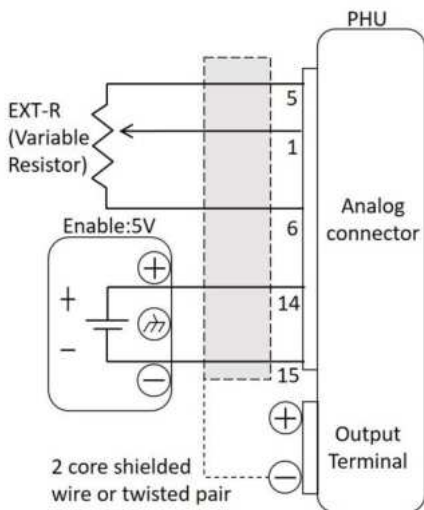

- Pin5 → VREF
- Pin1 → EXT-V/R CV CONT
- Pin6 or Pin10 or Pin24 or Pin25 → Analog GND
- Pin14 → Enable (+)
- Pin15 or Pin16 or Pin23 → Enable (-)
- Wire shield → Negative (-) output terminal
- Variable resistor: 10 kΩ to 1 MΩ

Connection- alt. shielding If the wire shield needs to be grounded at the enable voltage source, then the shield cannot also be grounded at the negative (-) terminal output of the PHU power supply. This would short the output.

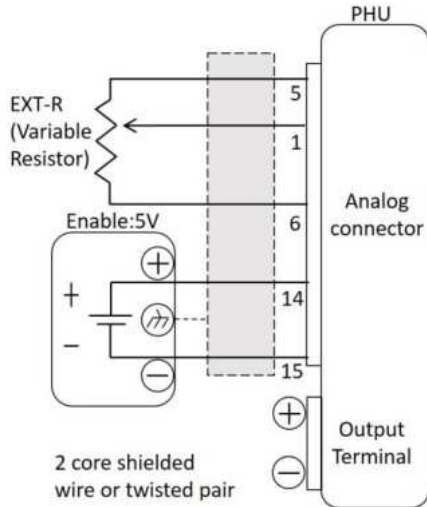

- Pin5 → VREF
- Pin1 → EXT-V/R CV CONT
- Pin6 or Pin10 or Pin24 or Pin25 → Analog GND
- Pin14 → Enable (+)
- Pin15 or Pin16 or Pin23 → Enable (-)
- Wire shield → Enable voltage ground (GND)
- Variable resistor: 10 kΩ to 1 MΩ

Panel operation 1. Connect the external voltage according to the connection diagrams above.

2. Press the menu button and enter the “Configuration” icon.

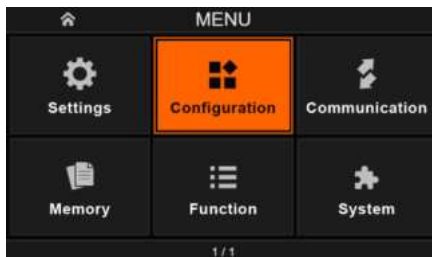

3. Choose the “Analog interface” in the Configuration page.



4. Check “Voltage control”.



Note

Use a stable voltage supply for the external voltage control.



CAUTION

Ensure the voltage polarity is correct when connecting the external voltage.

Ensure no more than 5.25 volts are input into the external voltage input (enable: 5V).

External Resistance Control of Current Output

Background External Resistance control of the current output is accomplished using the analog control connector on the rear panel. There are two external voltage control ranges, 0 V to 5 V and 0 V to 10 V, depending on the configuration.

For 0 V to 10 V:

Output power = full scale power x (external voltage/10)

PIN 5 (VREF) will output 10V.

For 0 V to 5 V:

Output power = full scale power x (external voltage/5)

PIN 5 (VREF) will output 5V.

(Setting Path: Menu/Configuration/ Analog interface/page2)

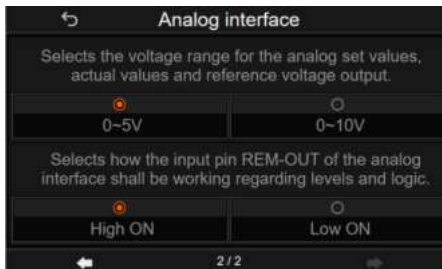

Connection When connecting the external resistance to the connectors, use shielded or twisted paired wiring.

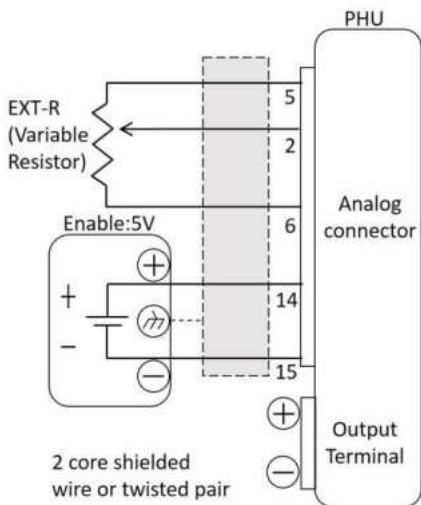

- Pin5 → VREF
- Pin2 → EXT-V/R CC CONT
- Pin6 or Pin10 or Pin24 or Pin25 → Analog GND
- Pin14 → Enable (+)
- Pin15 or Pin16 or Pin23 → Enable (-)
- Wire shield → Negative (-) output terminal
- Variable resistor: 10 kΩ to 1 MΩ

Connection- alt. shielding If the wire shield needs to be grounded at the enable voltage source, then the shield cannot also be grounded at the negative (-) terminal output of the PHU power supply. This would short the output.

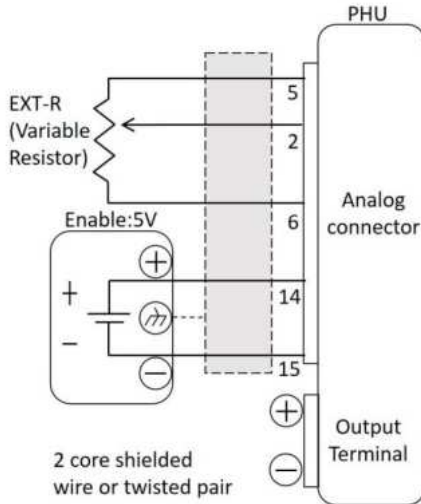

- Pin5 → VREF
- Pin2 → EXT-V/R CC CONT
- Pin6 or Pin10 or Pin24 or Pin25 → Analog GND
- Pin14 → Enable (+)
- Pin15 or Pin16 or Pin23 → Enable (-)
- Wire shield → Enable voltage ground (GND)
- Variable resistor: 10 kΩ to 1 MΩ

Panel operation 1. Connect the external voltage according to the connection diagrams above.

- Press the menu button and enter the “Configuration” icon.

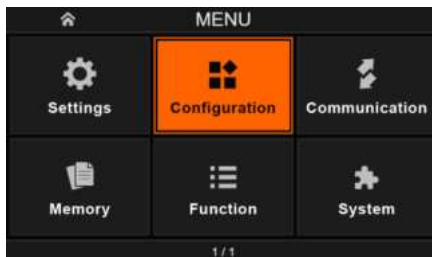

- Choose the “Analog interface” in the Configuration page.



- Check “Current control”.



Note

Use a stable voltage supply for the external voltage control.



CAUTION

Ensure the voltage polarity is correct when connecting the external voltage.

Ensure no more than 5.25 volts are input into the external voltage input (enable: 5V).

External Resistance Control of Power Output

Background External Resistance control of the power output is accomplished using the analog control connector on the rear panel. There are two external voltage control ranges, 0 V to 5 V and 0 V to 10 V, depending on the configuration.

For 0 V to 10 V:

Output power = full scale power x (external voltage/10)

PIN 5 (VREF) will output 10V.

For 0 V to 5 V:

Output power = full scale power x (external voltage/5)

PIN 5 (VREF) will output 5V.

(Setting Path: Menu/Configuration/ Analog interface/page2)

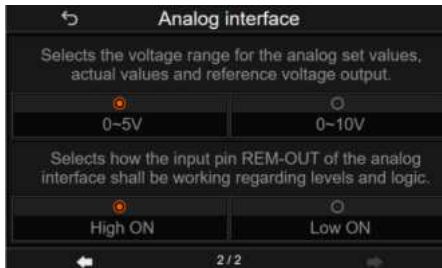

Connection When connecting the external resistance to the connectors, use shielded or twisted paired wiring.

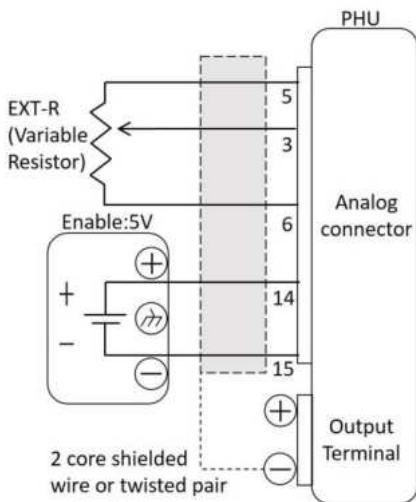

- Pin5 → VREF
- Pin3 → EXT-V/R CP CONT
- Pin6 or Pin10 or Pin24 or Pin25 → Analog GND
- Pin14 → Enable (+)
- Pin15 or Pin16 or Pin23 → Enable (-)
- Wire shield → Negative (-) output terminal
- Variable resistor: 10 kΩ to 1 MΩ

Connection- alt. shielding If the wire shield needs to be grounded at the enable voltage source, then the shield cannot also be grounded at the negative (-) terminal output of the PHU power supply. This would short the output.

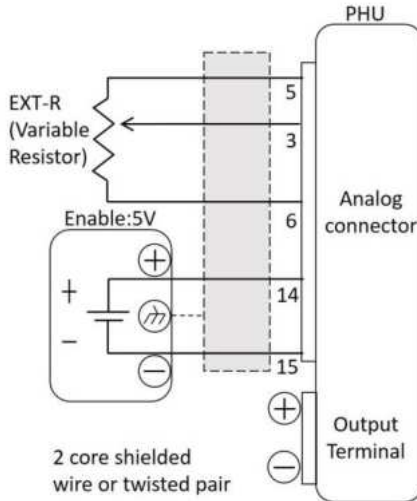

- Pin5 → VREF
- Pin3 → EXT-V/R CP CONT
- Pin6 or Pin10 or Pin24 or Pin25 → Analog GND
- Pin14 → Enable (+)
- Pin15 or Pin16 or Pin23 → Enable (-)
- Wire shield → Enable voltage ground (GND)
- Variable resistor: 10 kΩ to 1 MΩ

Panel operation 1. Connect the external voltage according to the connection diagrams above.

2. Press the menu button and enter the “Configuration” icon.



3. Choose the “Analog interface” in the Configuration page.



4. Check “Power control”.



Note

Use a stable voltage supply for the external voltage control.



CAUTION

Ensure the voltage polarity is correct when connecting the external voltage.

Ensure no more than 5.25 volts are input into the external voltage input (enable: 5V).

External Resistance Control of Internal Resistance Output

Background External Resistance control of the internal resistance is accomplished using the analog control connector on the rear panel. There are two external voltage control ranges, 0 V to 5 V and 0 V to 10 V, depending on the configuration.

For 0 V to 10 V:

Output power = full scale power x (external voltage/10)

PIN 5 (VREF) will output 10V.

For 0 V to 5 V:

Output power = full scale power x (external voltage/5)

PIN 5 (VREF) will output 5V.

(Setting Path: Menu/Configuration/ Analog interface/page2)

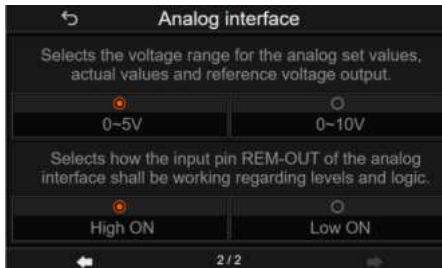

Connection When connecting the external resistance to the connectors, use shielded or twisted paired wiring.

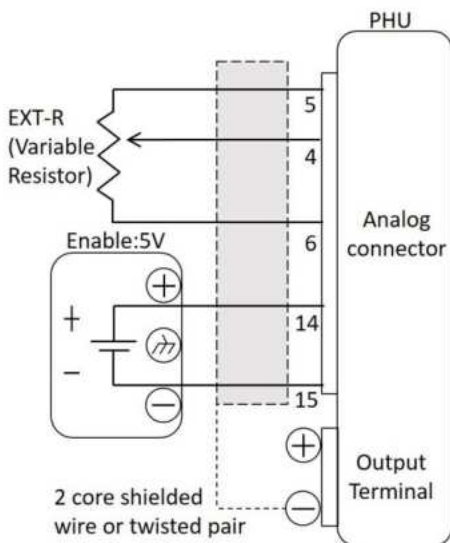

- Pin5 → VREF
- Pin4 → EXT-V/R IN_R CONT
- Pin6 or Pin10 or Pin24 or Pin25 → Analog GND
- Pin14 → Enable (+)
- Pin15 or Pin16 or Pin23 → Enable (-)
- Wire shield → Negative (-) output terminal
- Variable resistor: 10 kΩ to 1 MΩ

Connection- alt. shielding If the wire shield needs to be grounded at the enable voltage source, then the shield cannot also be grounded at the negative (-) terminal output of the PHU power supply. This would short the output.

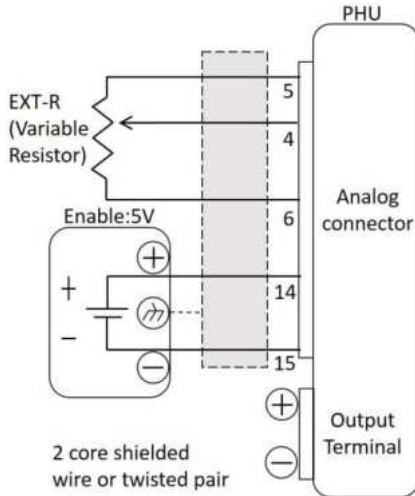

- Pin5 → VREF
- Pin4 → EXT-V/R IN_R CONT
- Pin6 or Pin10 or Pin24 or Pin25 → Analog GND
- Pin14 → Enable (+)
- Pin15 or Pin16 or Pin23 → Enable (-)
- Wire shield → Enable voltage ground (GND)
- Variable resistor: 10 kΩ to 1 MΩ

Panel operation 1. Connect the external voltage according to the connection diagrams above.

- Press the menu button and enter the “Configuration” icon.



- Choose the “Analog interface” in the Configuration page.



- Check “Resistance control”.



Note

Use a stable voltage supply for the external voltage control.



CAUTION

Ensure the voltage polarity is correct when connecting the external voltage.

Ensure no more than 5.25 volts are input into the external voltage input (enable: 5V).

External Voltage Control of Output

Background The output can be turned on or off externally using input 0 V or 5 V. The analog control connector can be set to turn the output on from a high or low signal.

When set to High On, the output is turned on when input 5 V, the output is turned off when input 0 V.

When Low On, the output is turned on when input 0 V, the output is turned off when input 5 V.

(Setting Path: Menu/Configuration/Analog interface/page2)

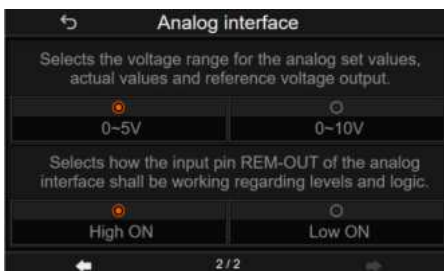

Connection When connecting the external voltage source to the connectors, use shielded or twisted paired wiring.

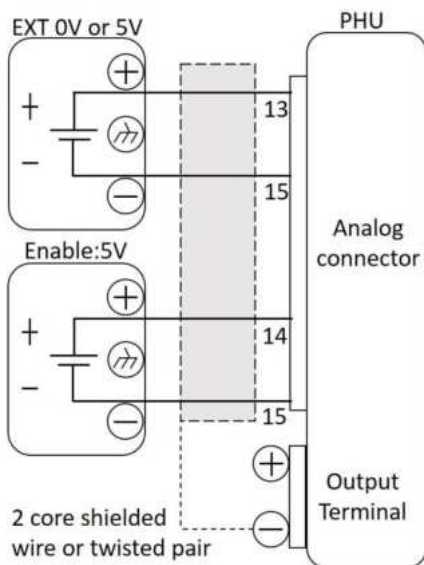

- Pin13 → EXT (+)
- Pin15 or Pin16 or Pin23 → digital GND or Enable (-)
- Pin14 → Enable (+)
- Wire shield → Negative (-) output terminal

Connection- alt. shielding If the wire shield needs to be grounded at the enable voltage source, then the shield cannot also be grounded at the negative (-) terminal output of the PHU power supply. This would short the output.

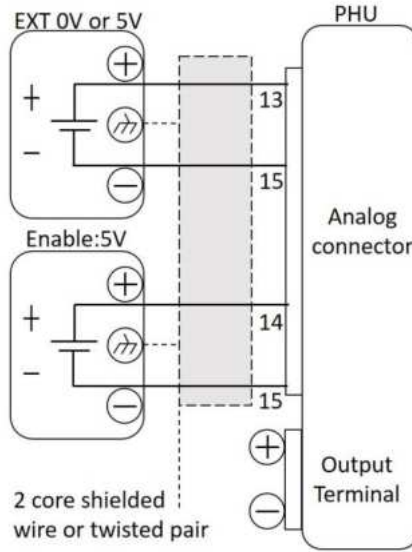

- Pin13 → EXT (+)
- Pin15 or Pin16 or Pin23 → digital GND or Enable (-)
- Pin14 → Enable (+)
- Wire shield → Enable voltage ground (GND)

Panel operation 1. Connect the external voltage according to the connection diagrams above.

2. Press the menu button and enter the “Configuration” icon.



3. Choose the “Analog interface” in the Configuration page.



4. Check “REM-OUT control”.



5. Choose High ON or Low ON on the second page.

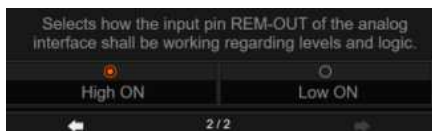

Note

Use a stable voltage supply for the external voltage control.



CAUTION

Ensure the voltage polarity is correct when connecting the external voltage.

Ensure no more than 5.25 volts are input into the external voltage input.

External voltage control of Alarm input

- Background** When a +4.5 V to +5 V high signal is input to PIN12 (Alarm input), it will forcibly turn off the PHU OUTPUT.
- Connection** When connecting the external voltage source to the connectors, use shielded or twisted paired wiring.

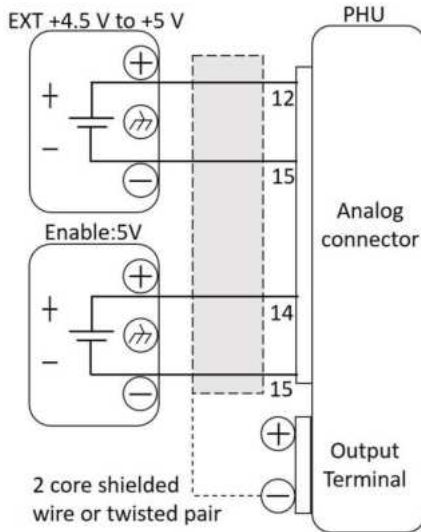

- Pin12 → EXT (+)
- Pin15 or Pin16 or Pin23 → digital GND or Enable (-)
- Pin14 → Enable (+)
- Wire shield → Negative (-) output terminal

Connection- alt. shielding If the wire shield needs to be grounded at the enable voltage source, then the shield cannot also be grounded at the negative (-) terminal output of the PHU power supply. This would short the output.

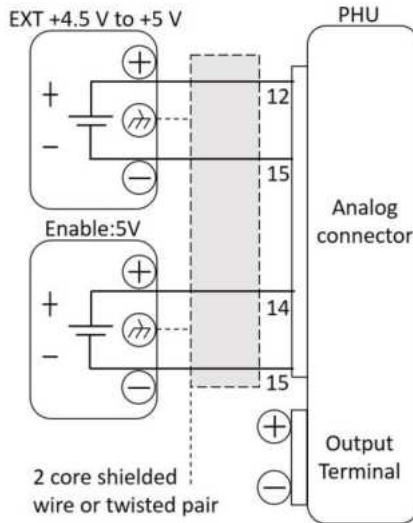

- Pin12 → EXT (+)
- Pin15 or Pin16 or Pin23 → digital GND or Enable (-)
- Pin14 → Enable(+)
- Wire shield → Enable voltage ground (GND)



Note

Use a stable voltage supply for the external voltage control.



CAUTION

Ensure the voltage polarity is correct when connecting the external voltage.

Ensure no more than 5.25 volts are input into the external voltage input.

Remote Monitoring

The PHU power supplies have remote monitoring support for current, voltage and power output. They also support monitoring of operation and alarm status.

- External monitoring of output voltage, current and power → from page 170
- External monitoring of operation mode and alarm status → from page 173

External Voltage, Current and Power Monitoring

Background	<p>The analog connector is used to monitor the current (IMON), voltage (VMON) and power (PMON) output.</p> <p>An output of 0 V to 10 V or 0 V to 5 V (depending on the configuration) represents the voltage or current output of 0 to rated current/voltage output.</p> <ul style="list-style-type: none">• $IMON = (\text{current output}/\text{full scale}) \times 10 \text{ or } 5.$• $VMON = (\text{voltage output}/\text{full scale}) \times 10 \text{ or } 5.$• $PMON = (\text{power output}/\text{full scale}) \times 10 \text{ or } 5.$
Configuration	<p>The PHU doesn't need to be configured to use external voltage, current monitoring or power monitoring however the voltage or current output range does need to be configured. The monitor output voltage can be configured as either 0 V to 10 V or 0 V to 5 V.</p> <p>(Setting Path: Menu/Configuration/Analog interface/page2)</p>

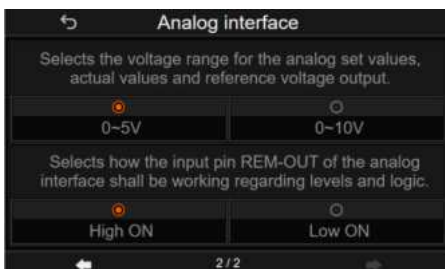

An external DMM can now be used to monitor the voltage or current output.

VMON Connection

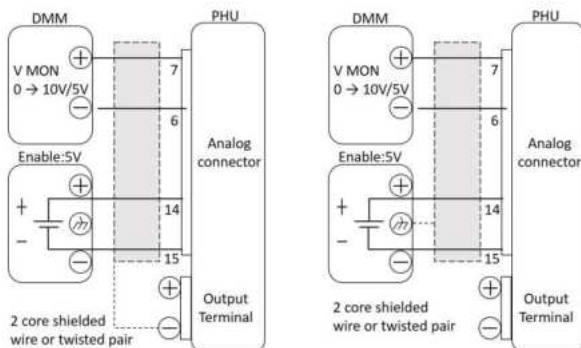

- Pin7 → DMM (+)
- Pin6 or Pin10 or Pin24 or Pin25 → DMM (-)
- Pin14 → Enable(+)
- Pin15 or Pin16 or Pin23 →Enable (-)

IMON Connection

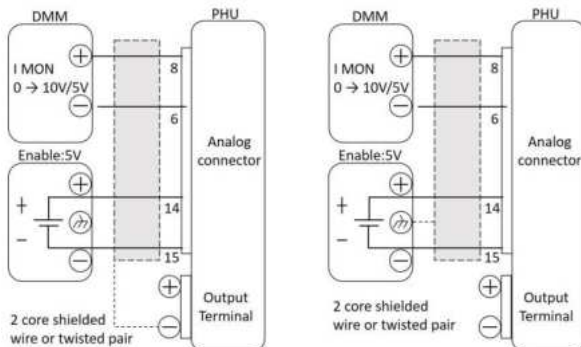

- Pin8 → DMM (+)
- Pin6 or Pin10 or Pin24 or Pin25 → DMM (-)
- Pin14 → Enable(+)
- Pin15 or Pin16 or Pin23 →Enable (-)

PMON Connection

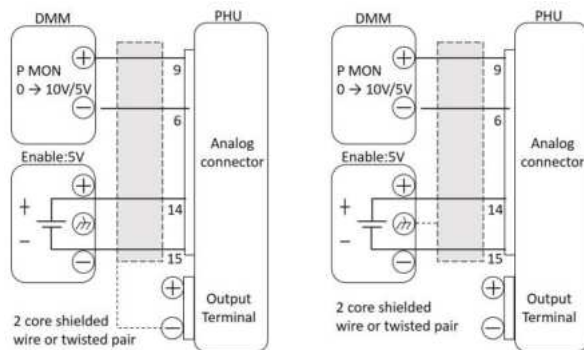

- Pin9 → DMM (+)
- Pin6 or Pin10 or Pin24 or Pin25 → DMM (-)
- Pin14 → Enable(+)
- Pin15 or Pin16 or Pin23 →Enable (-)

! Note

Maximum current is 5 mA. Ensure the sensing circuit has input impedance greater than 1MΩ.

The monitor outputs are strictly DC and should not be used to monitor analog components such as transient voltage response or ripple etc.

! CAUTION

Ensure IMON (pin 7), VMON (pin 8) and PMON (pin 9) are not shorted together. This may cause damage to the unit.

External Operation and Status Monitoring

Background The analog control connector can also be used to monitor the status operation and alarm status of the instrument.

The pins are isolated from the power supply internal circuitry by photo couplers. Status Com (Pin 15), Status Com (Pin 16) and Status Com (Pin 23) are photo coupler emitter outputs, whilst pins 17 to 22 are photo coupler collector outputs.

A maximum of 30V and 8mA can be applied to each pin. The Status Com pin is floating with an isolation voltage of 60V.

Pinout	Name and Pin	Description
	STATUS COM	15 16 23 Common (photo coupler emitter) for status signals 17 to 22.
	OUT ON STATUS	17 Low when the output is on.
	PWR ON STATUS	18 Active low.
	ALM STATUS	19 Low when any of the protection modes are tripped. Active low.
	CV STATUS	20 Low when CV mode is active.
	CC STATUS	21 Low when CC mode is active.
	CP STATUS	22 Low when CP mode is active.

Schematic

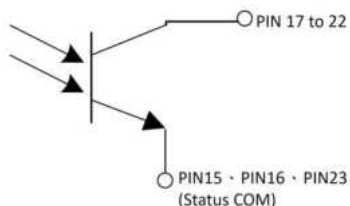

Timing diagrams Below are 6 example timing diagrams covering a number of scenarios. Note that pins 17 to 19 are all active low.

CV MODE: The diagram below shows the timing diagram when the output is turned on when the PHU is in the CV mode. (The PHU output mode is set to CVHS mode.)
 Output turned on

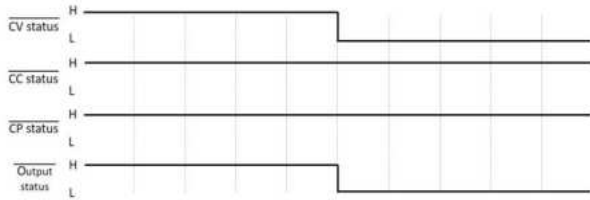

CV MODE: The diagram below shows the output status lines when the output is turned off in CV mode.
 Output turned off

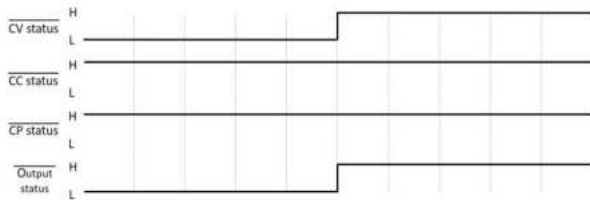

CC MODE: The diagram below shows the timing diagram when the output is turned on when the PHU is in the CC mode. (The PHU output mode is set to CCHS mode.)
 Output turned on

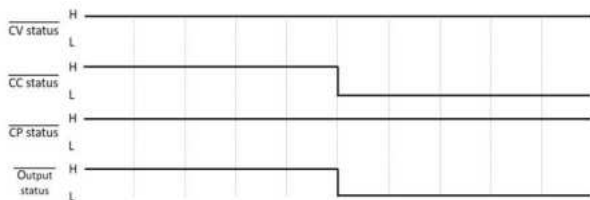

CC MODE: The diagram below shows the output status lines when the output is turned off in CC mode.
 Output turned off

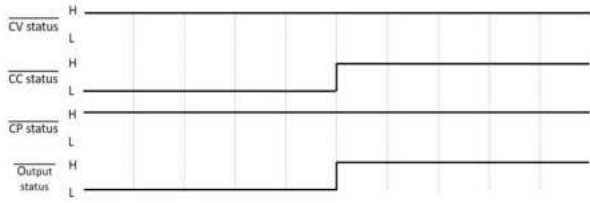

CP MODE: The diagram below shows the timing diagram
 Output turned on when the output is turned on when the PHU is in
 the CP mode. (The PHU output mode is set to
 CVHS mode.)

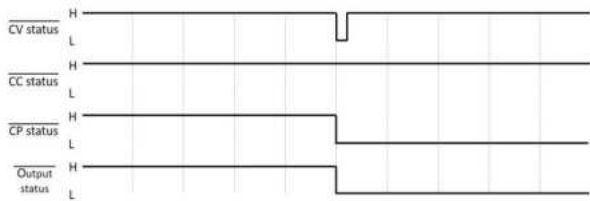

CP MODE: The diagram below shows the output status lines
 Output turned off when the output is turned off in CP mode.

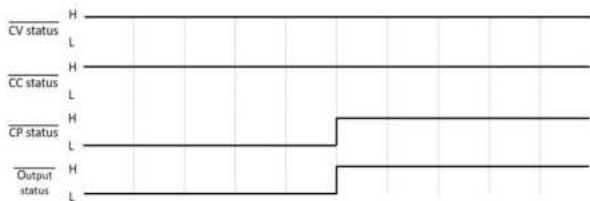

C COMMUNICATION

INTERFACE

This chapter describes basic configuration of IEEE488.2 based remote control. For a command list, refer to the programming manual, downloadable from GW Instek website, www.gwinstek.com

Interface Configuration	177
USB Remote Interface	177
Configuration.....	177
Function Check.....	178
GPIB Remote Interface (optional)	179
Configuration.....	179
GPIB Function Check	181
RS232/485 Remote Interface (optional)	185
Configure RS232/485	185
RS232/485 Function Check	188
Configure Ethernet Connection.....	189
Web Server Configuration	189
Web Server Remote Control Function Check.....	190
Sockets Server Configuration	191
Socket Server Function Check	192

Interface Configuration

USB Remote Interface

Configuration

USB Configuration	PC side connector	Type A, host
	PHU side connector	Rear panel Type B, slave
	Speed	1.1/2.0 (full speed/high speed)
	USB Class	TMC, CDC (communications device class)

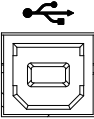
- | | | |
|-------|---|---|
| Steps | 1. Connect the USB cable to the rear panel USB B port. |  |
| | 2. If you are not using the rear panel USB device port, set Rear USB Disable. | Page 114 |

 Note	If you are not using the rear panel USB device port, set Rear USB Disable.	Page 114
---	--	----------

- The interface state indication area of display will show the status.

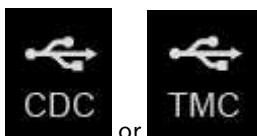

Function Check

Functionality
check

Invoke a terminal application such as Realterm.

To check the COM port No., see the Device Manager in the PC. For WinXP; Control panel → System → Hardware tab.

Run this query command via the terminal application after the instrument has been configured for USB remote control.

*idn?

This should return the Manufacturer, Model number, Serial number, and Firmware version in the following format.

```
GW-INSTEK, PHU500-  
90,GW0473500400,01.26.20241001.001\n
```

Manufacturer: GW-INSTEK

Model number : PHU 500-90

Serial number : GW0473500400

Firmware version : 01.26.20241001.001



Note

For further details, please see the programming manual, available on the GW Instek web site @ www.gwinstek.com.

GPIB Remote Interface (optional)

Configuration

To use GPIB, the optional GPIB option (GW Instek part number: PHU-IF01) must be installed. This is a factory installed option and cannot be installed by the end-user. Only one GPIB address can be used at a time.

- Configure GPIB
1. Ensure the PHU is off before proceeding.
 2. Connect a GPIB cable from a GPIB controller to the GPIB port on the PHU.
 3. Turn the PHU on.
 4. Press the menu key and enter the communication page, choose the "GPIB".

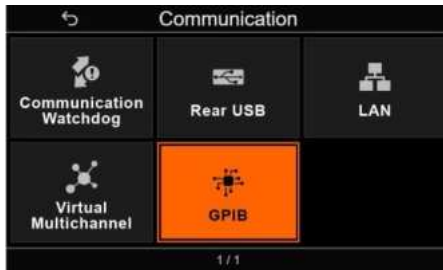
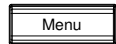

5. Set the following GPIB settings.



GPIB address 1 to 30

6. Check to see that the GPIB option is detected by the PHU. The block of the slot interface indicates the GPIB port status.

Indicates that the GPIB port is available.



-
- GPIB constraints
- Maximum 15 devices altogether, 20m cable length, 2m between each device
 - Unique address assigned to each device
 - At least 2/3 of the devices turned On
 - No loop or parallel connection

GPIB Function Check

Background To test the GPIB functionality, National Instruments Measurement and Automation Explorer can be used. Users need to install NI488.2.

This program is available on the NI website, <https://www.ni.com/zh-tw/support/downloads/drivers/download.ni-488-2.html?srsId=AfmBOorwcT9YDSbI4PEapGQiZDjEP1dMt4ptuwAMECIp1RjR-zwmZEOP#544048>

Requirements Operating System: Windows XP, 7, 8

Functionality check

1. Start the NI Measurement and Automation Explorer (MAX) program. Using Windows, press:

Start>All Programs>NI Max



2. From the Configuration panel access; *My System>Devices and Interfaces>GPIB*
3. Press *Scan for Instruments*.

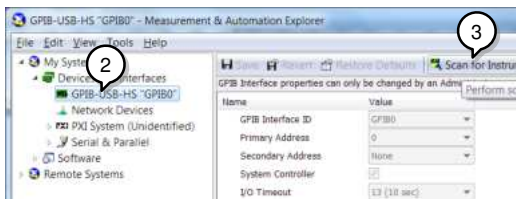

4. Select the device (GPIB address of PHU) that now appears in the *System>Devices and Interfaces > GPIB-USB-HS "GPIBX"* node.
5. Click on the *VISA Properties* tab on the bottom.
6. Click *Open VISA Test Panel*.

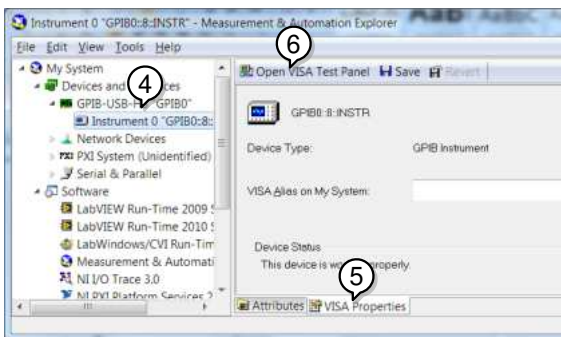

7. Click on *Configuration*.
8. Click on the *GPIB Settings* tab and confirm that the GPIB settings are correct.

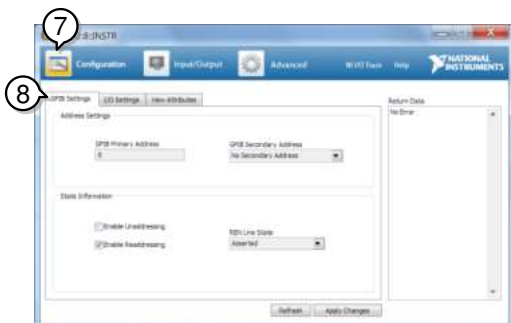

9. Click on the *I/O Settings* tab.
10. Make sure the *Enable Termination Character* check box is checked, and the terminal character is \n (Value: xA).
11. Click *Apply Changes*.

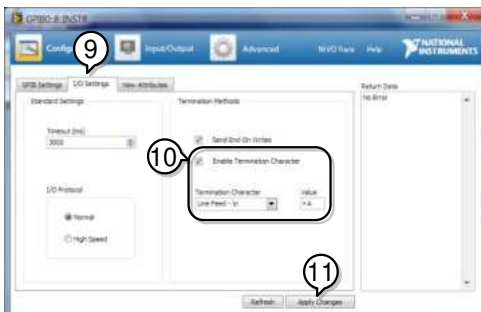

12. Click on *Input/Output*.
13. Click on the *Basic/IO* tab.
14. Enter *IDN? in the *Select or Enter Command* drop down box.
15. Click *Query*.
16. The *IDN? query will return the Manufacturer, model name, serial number and firmware version in the dialog box.
GW-INSTEK,PHU500-90,GW0473500400,01.26.20241001.001\n





Note

For further details, please see the programming manual, available on the GW Instek web site @ www.gwinstek.com.

RS232/485 Remote Interface (optional)

Configure RS232/485

Overview The PHU uses the RS232/485 interface card (IN & OUT ports) for communication coupled with RS232 or RS485 adapters.

The pin outs for the adapters are shown below.

RS232 cable with DB9 connector

DB-9 Connector			Remote IN Port (RJ-45)		Remark
Pin No.	Name		Pin No.	Name	
Housing	Shield	↔	Housing	Shield	
2	RX	↔	7	TX	Twisted pair
3	TX	↔	8	RX	
5	SG	↔	1	SG	

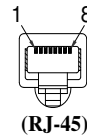
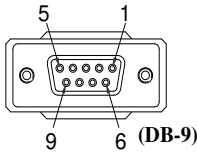

RS485 cable with DB9 connector

DB-9 Connector			Remote IN Port (RJ-45)		Remark
Pin No.	Name		Pin No.	Name	
Housing	Shield	↔	Housing	Shield	
9	TXD-	↔	6	RXD-	Twisted pair
8	TXD+	↔	3	RXD+	
1	SG	↔	1	SG	
5	RXD-	↔	5	TXD-	Twisted pair
4	TXD+	↔	4	TXD+	

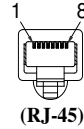
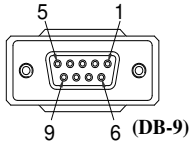

To use RS485-2W, please refer to this wiring

User's RS485-2W		DB-9 Connector (RS485 cable with DB9 connector)	
Name		Pin No.	Name
		Housing	Shield
DATA+	←→	8	TXD+
	↘	4	RXD+
SG	←→	1	SG
DATA-	←→	9	TXD-
	↘	5	RXD-

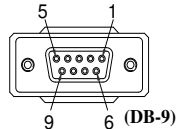

Diagram of End terminal connector



End terminal connector from PHU-232 or PHU-485 connection kit.	End terminal connector	
	8 Pin Connector	
	Pin No.	Remarks
	3	Internal shorted
	7	
	4	Internal shorted
	8	

Steps

1. Connect the RS232 serial cable or RS485 serial cable to the Remote IN port on the rear panel.

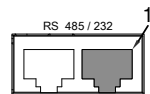

Connect the other end of the cable to the PC.

2. Connect the end terminal connector to the Remote OUT port on the rear panel.

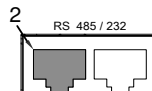

3. Press the menu key to enter the communication page, choose the RS232/485.

Set the following RS232/RS485 settings:

baud rate	2400/ 4800/ 9600/ 19200/ 38400/
settings	57600/ 115200

Address	0 to 31
---------	---------

4. The Block of interface state will display this icon when a remote connection has been established.



RS232/485 Function Check

Functionality check Invoke a terminal application such as Realterm.

To check the COM port No, see the Device Manager in the PC. For Win 11; Control panel → System → Hardware tab.

Run this query command via the terminal application after the instrument has been configured for either RS232 or RS485 remote control.

SCPI commands	Command or response	Status
	*IDN?	Typing
	GW-INSTEK, PHU500-90,GW0473500400,01.26.20241001.001\n	Return
	Return the manufacturer, model, serial number, and firmware version in the above format.	Note
	Manufacturer: GW-INSTEK	
	Model: PHU 500-90	
	Serial number: GW0473500400	
	Firmware version: 01.26.20241001.001	

Configure Ethernet Connection

The Ethernet interface can be configured for a number of different applications. Ethernet can be configured for basic remote control or monitoring using a web server or it can be configured as a socket server.

The PHU series supports both DHCP connections so the instrument can be automatically connected to an existing network or alternatively, network settings can be manually configured.

Ethernet configuration Parameters	For details on how to configure the Ethernet settings, please see the configuration chapter on page 114.
-----------------------------------	--

Web Server Configuration

Configuration	This configuration example will configure the PHU as a web server and use DHCP to automatically assign an IP address to the PHU.
---------------	--

1. Connect an Ethernet cable from the network to the rear panel Ethernet port.
2. Press the Menu key to enter the LAN settings in the communication page.

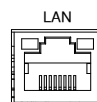

Set the following LAN settings:

Set IP allocation Manual or DHCP

- Set IP Address
- Set Gateway
- Set Subnet mask
- Set Port
- Set Web control Enable or disable
- Set Host name
- Set Web password
- Set Domain name
- Set TCP Keep-alive Enable or disable

- 3. The block of ethernet will display an icon when a network cable is plugged in.



Web Server Remote Control Function Check

Functionality check

Enter the IP address of the power supply in a web browser after the instrument has been configured as a web server.

The web server allows you to monitor the function settings of the PHU.

You can check the IP address by checking the LAN setting.



(The image is for example.)

2. Press the Menu key to enter the LAN settings.

Set the following LAN settings:

Set IP allocation Manual or DHCP

Set IP Address

Set Gateway

Set Subnet mask

Set Port

Set Web control Enable or disable

Set Host name

Set Web password

Set Domain name

Set TCP Keep-alive Enable or disable

Socket Server Function Check

Background	To test the socket server functionality, National Instruments Measurement and Automation Explorer can be used. This program is available on the NI website, www.ni.com , via a search for the VISA Run-time Engine page, or “downloads” at the following URL, http://www.ni.com/visa/
------------	---

Requirements	Operating System: Windows 7, 8, 10, 11
--------------	--

Functionality check	<ol style="list-style-type: none"> 1. Start the NI Measurement and Automation Explorer (MAX) program. Using Windows, press:
---------------------	--

Start>All Programs>NI Max



2. From the Configuration panel access;
My System>Devices and Interfaces>Network Devices
3. Press *Add New Network Device>VISA TCP/IP Resource...*

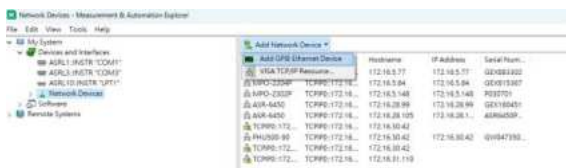

4. Select *Manual Entry of Raw Socket* from the popup window.

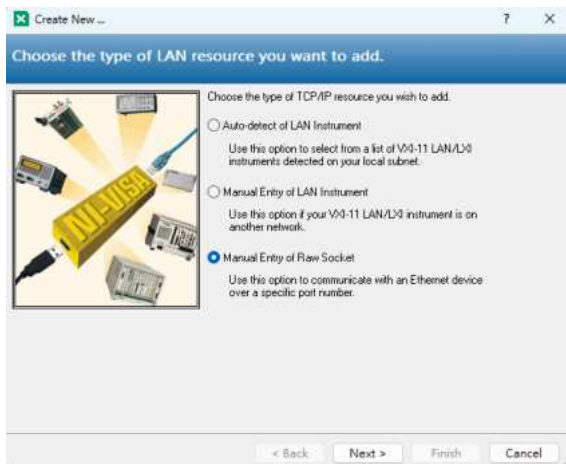

5. Enter the IP address and the port number of the PHU. The default port number is 5025.
6. Click the Validate button.
7. A popup will appear if a connection is successfully established.
8. Click Next.



9. Next configure the Alias (name) of the PHU connection. In this example the Alias is: PHU500-90
10. Click finish.

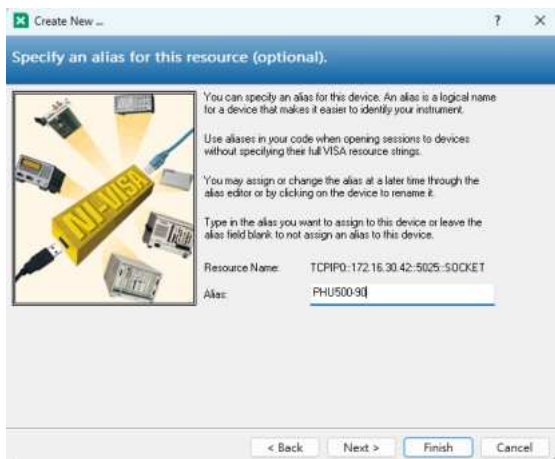

11. The IP address of the PHU will now appear under Network Devices in the configuration panel. Select this icon now.

12. Click *Open VISA Test Panel*.

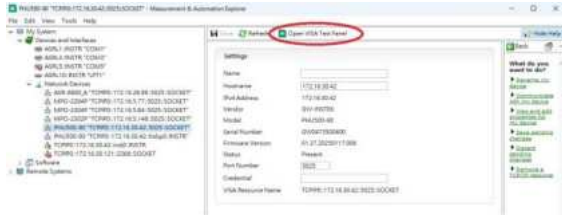

13. Click the *Configuration* icon,

14. Click on *I/O Settings*.

15. Make sure the *Enable Termination Character* check box is checked, and the terminal character is \n (Value: xA).

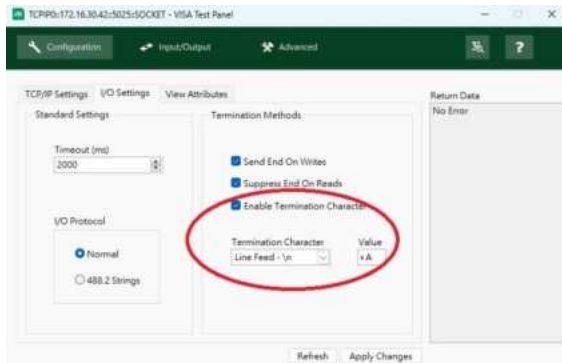

16. Click *Apply Changes*.

17. Click the *Input/Output* icon.

18. Enter **IDN?* in the *Select or Enter Command* dialog box if it is not already.

19. Click the *Query* button.

20. The **IDN?* query will return the Manufacturer, model name, serial number and firmware

version in the dialog box.

GW-INSTEK,PHU500-90,GW0473500400,01.37

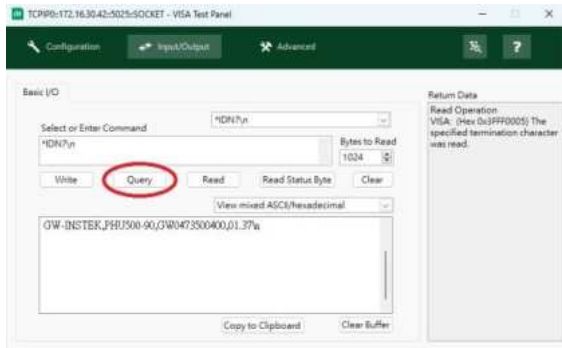

Note

For further details, please see the programming manual, available on the GW Instek web site @ www.gwinstek.com.

FAQ

- The OVP voltage is triggered earlier than expected.
- Can I combine more than 1 cable together for the output wiring?
- The accuracy does not match the specification.

The OVP voltage is triggered earlier than expected.

When setting the OVP voltage, take into account the voltage drop from the load cables. As the OVP level is set from the output terminals and not the load terminals, the voltage at the load terminals may be slightly lower.

Can I combine more than 1 cable together for the output wiring?

Yes. Cables can be used together (in parallel) if the current capacity of a single cable is insufficient. However the withstand voltage should also be taken into account. Ensure the cables are twisted together and are the same length.

The accuracy does not match the specification.

Make sure the device is powered On for at least 30 minutes, within +20°C ~ +30°C. This is necessary to stabilize the unit to match the specification.

For more information, contact your local dealer or GW Instek at www.gwinstek.com / marketing@goodwill.com.tw.

APPENDIX

PHU Factory Default Settings	199
Messages	201
PHU Specifications	210
Output.....	210
Constant Voltage Mode.....	210
Constant Current Mode.....	212
Protection Function	213
Other Function.....	215
Front Panel.....	216
Programming and Measurement (Digital Interface).....	218
Input Characteristics for PHU-C series (for 5kW models) ...	221
Input Characteristics for PHU-C series (for 10kW models) ..	221
Input Characteristics for PHU-C series (for 15kW models) ..	221
Input Characteristics for PHU-D series (for 5kW models) ...	222
Input Characteristics for PHU-D series (for 10kW models) ..	222
Input Characteristics for PHU-D series (for 15kW models) ..	222
Interface Capabilities	223
Isolated Analog Control Interface	223
Environment Conditions.....	223
General Specifications.....	224
PHU Dimensions	225
PHU-HV (PHU 500, 750, 1000, 1500)	225
PHU-LV (PHU 80, 200).....	226

PHU Factory Default Settings

The following default settings are the factory configuration settings for the power supply.

For details on how to return to the factory default settings, see page 52.



Settings	Default Setting
Output	Off
LOCK	Disabled
Voltage	0V
Current	0A
Internal resistance setting	0.000Ω
OVP	1.1 X Vr _{ate}
OCP	1.1 X Ir _{ate}
OPP	1.1 X Pr _{ate}
OCP Delay Time	0.1 sec
Current Setting Limit	1.05 X Ir _{ate}
Voltage Setting Limit	1.05 X Vr _{ate}
Power Setting Limit	1.02 X Pr _{ate}
Bleeder circuit control	ON
Output ON delay time	0.00 s
Output OFF delay time	0.00 s
output mode slew rate select	CV high speed priority (CVHS)
Rising/Falling voltage	Max(refer to page 67)
Rising/Falling current	Max(refer to page 67)
Under voltage detection	1.05 X Vr _{ate} action: NONE
Over voltage detection	1.05 X Vr _{ate} action: NONE
Under current detection	1.05 X Ir _{ate} action: NONE
Over current detection	1.05 X Ir _{ate} action: NONE
Over Power detection	1.02 X Pr _{ate} action: NONE
Configuration	Default Setting
Measurement Average Setting	Low
The panel is displayed at power-on.	Display the Voltage Current
The output state after power-on.	Output is OFF
Actions after power-on.	None
Remote control	Not allowed
Analog interface	None selected.
The voltage range for the analog	0 V to 5 V
PIN REM-OUT of the analog interface	High ON

Master-slave setting	Single
DIO Function	None
Communication	Default Setting
Communication Watchdog	1(s)/ None selected
Rear usb device mode	USB-CDC
LAN allocation	DHCP
LAN Port	5025
Web control	Enable
Host name	P-GW0473500400
Web password	Pw123QQ456
Domain name	Workgroup
TCP Keep-alive	Enable
Function	Default Setting
Sequence	no data
System	Default Setting
AC-FAIL protection	Auto
AC Power Recovery setting	Power off
Lock Mode	Allow output to turn off
Key sound	Activates
Alarm sound	Activates
Backlight off after 60s	Deactivates
Brightness adjust	50 %







Messages



The following messages may appear on the PHU screen during operation. (Corresponding to page 18)





Remote State Messages	Description
	local
Error	local + Error
RMT	Remote The device is in Remote status. Only the [Local] and [Output OFF] buttons are available.
RMT Error	Remote Error The device is in Remote status. A command error has occurred.
RWL	RWLock The device is in Remote + Lock status. All buttons are inactive.
RWL Error	RWLock + Error The device is in Remote + Lock status. A command error has occurred.
LRMT	Local + Remote The device is in Local + Remote status. All buttons are functional, with remote control active simultaneously.
LRMT Error	Local + Remote The device is in Local + Remote status. A command error has occurred.
Protection State Messages*	Description
	None
PF	PF (Power Fail)







OVP	OVP (Over-Voltage Protection)
OCP	OCP (Over-Current Protection)
OPP	OPP (Over-Power Protection)
 OTP	OTP (Over-Temperature Protection)
SLF	SLF (Sense Lead Fault)
MSP	MSP (Master-Slave Protection)
PUF	PUF (Power Unit Fail)
WDOG	WDOG (communication Watchdog)
EXT Alarm	EXT Alarm (Shutdown for Analog Interface)
 Alarm	System error or Hardware error.
LLF	LLF (Load Lead Fault)
PUF1	PUF1 (Power Unit 1 Fault)
PUF2	PUF2 (Power Unit 2 Fault)
PUF3	PUF3 (Power Unit 3 Fault)
PUF4	PUF4 (Power Unit 4 Fault)
PUF5	PUF5 (Power Unit 5 Fault)
PUF6	PUF6 (Power Unit 6 Fault)

FAN1	FAN1 (FAN 1 Fault)
FAN2	FAN2 (FAN 2 Fault)
FAN3	FAN3 (FAN 3 Fault)
UVA	UVA (Under Voltage Alarm) (When the UVD action is set to "ALARM")
OVA	OVA (Over Voltage Alarm) (When the OVD action is set to "ALARM")
UCA	UCA (Under Current Alarm) (When the UCD action is set to "ALARM")
OCA	OCA (Over Current Alarm) (When the OCD action is set to "ALARM")
OPA	OPA (Over Power Alarm) (When the OPD action is set to "ALARM")

Front USB State Messages	Description
	None
	USB Storage ON
	USB Storage Access
	USB Storage Error
	USB Storage Log active
	USB Storage Log access
	USB Storage Log abnormal

Rear USB State Messages	Description
	None
	USB-CDC
	USB-TMC

Ethernet State Messages	Description
	LAN OFF
	LAN ON
	LAN Connect-1
	LAN Connect-2

GPIB.....interface state Messages	Description
	None
	GPIB
	RS485
	CAN Bus
	DeviceNet.
	Isolation IO

Function state Messages	Description
	None
SEQ	Sequence
Battery simulation	Battery simulation
Battery charge	Battery charge
DIN 40839	DIN 40839
SAS PV / FC EN 50530	Solar Array Simulator EN50530

Output Mode Messages	Description
CVHS	Output Mode: CV high speed priority
CCHS	Output Mode: CC high speed priority
CVLS	Output Mode: CV slew rate priority
CCLS	Output Mode: CC slew rate priority

Output Delay state Messages	Description
	None
Dly On Dly Off	Both Output ON delay time and Output OFF delay time are set to non-zero values.
Dly On	Output ON delay time is set to non-zero values. Output OFF delay time is set to zero.

Dly Off	Output ON delay time is set to zero. Output OFF delay time is set to non-zero values.
----------------	--

Bleeder control state Messages	Description
--------------------------------	-------------



Bleeder ON	Turns ON the bleeder resistor.
Bleeder OFF	Turns OFF the bleeder resistor.

Bleeder Auto When set to AUTO, the bleeder resistor operates in synchronization with the output, automatically turning on when the output is enabled and turning off when the output is disabled.

Parallel setting state Messages	Description
---------------------------------	-------------



Master	When the PHU is used in parallel, "Master" indicates that this machine is set as the master.
---------------	--

Buzzer setting state Messages	Description
-------------------------------	-------------

ON 	Key sound : Activates
OFF 	Key sound : Deactivates

Detect state Messages**	Description
-------------------------	-------------

	None
UVD	Under Voltage Detected (V)
OVD	Over Voltage Detected (V)
UCD	Under Current Detected (A)
OCD	Over Current Detected (A)

OPD	Over Power Detected (W)
Delay output state Messages	Description
	None
DlyOn	Output ON delay time is set to non-zero values. (This icon will remain displayed until the output is turned on, at which point it will disappear.)
DlyOff	Output OFF delay time is set to non-zero values. (This icon will remain displayed until the output is turned off, at which point it will disappear.)
Output state Messages	Description
OFF	Output is turned off.
CV	Output is turned on. (CV status)
CC	Output is turned on. (CC status)
CP	Output is turned on. (CP status)
OUT	Unknown status or transitioning from CV to CC.
Fan state Messages	Description
	None
Running	The Sequence System is running.
CAL	Entering Remote Calibration.
Loading	Loading data into the Sequence System.
	
	

Waiting	Waiting for SEQ Trig IN.
Pause	The Sequence System has entered Pause mode. Press the ESC key to resume execution.
Sleep	An AC drop has occurred, and the Sequence System has entered Sleep mode.
Wake	The AC drop has been cleared, and the Sequence System is starting.

Output setting Messages	Description (The values in the image are for reference only.)
Voltage (V)	
88.888 UVL	Under voltage limit (the part with yellow text)
Voltage (V)	
88.888 OVL	Over voltage limit (the part with yellow text)
Current (A)	
888.88 UCL	Under current limit (the part with yellow text)
Current (A)	
888.88 OCL	Over current limit (the part with yellow text)
Power (W)	
8888.8 OPL	Over power limit (the part with yellow text)
Resistor (Ω)	
888888 ORL	Over resistance limit (the part with yellow text)

- * The user can view all protection statuses by pressing the “SHIFT” key + “9”.
- ** You need to set Action to “signal” for these prompts to appear.

PHU Specifications

The specifications apply when the PHU is powered on for at least 30 minutes.

Output

Model	PHU	80-170	200-70	500-30	750-20	1000-15
Rated Output Voltage ^{*1}	V	80	200	500	750	1000
Rated Output Current ^{*2}	A	170	70	30	20	15
Rated Output Power	W	5000	5000	5000	5000	5000
Output power ratio	-	2.72	2.8	3	3	3

Model	PHU	1500-10	80-340	200-140	500-60	750-40
Rated Output Voltage ^{*1}	V	1500	80	200	500	750
Rated Output Current ^{*2}	A	10	340	140	60	40
Rated Output Power	W	5000	10000	10000	10000	10000
Output power ratio	-	3	2.72	2.8	3	3

Model	PHU	1000-30	1500-20	80-510	200-210	500-90
Rated Output Voltage ^{*1}	V	1000	1500	80	200	500
Rated Output Current ^{*2}	A	30	20	510	210	90
Rated Output Power	W	10000	10000	15000	15000	15000
Output power ratio	-	3	3	2.72	2.8	3

Model	PHU	750-60	1000-45	1500-30
Rated Output Voltage ^{*1}	V	750	1000	1500
Rated Output Current ^{*2}	A	60	45	30
Rated Output Power	W	15000	15000	15000
Output power ratio	-	3	3	3

Constant Voltage Mode

Model	PHU	80-170	200-70	500-30	750-20	1000-15	
Line regulation ^{*3} [0.01% of Vo_rated]	mV	8	20	50	75	100	
Load regulation ^{*4} [0.02% of Vo_rated]	mV	16	40	100	150	200	
Ripple and noise ^{*5}	p-p ^{*6}	mV	200	300	350	800	1600
	r.m.s. ^{*7}	mV	16	40	70	200	350
Temperature coefficient	ppm / °C	100ppm/°C of rated output voltage, after a 30 minute warm-up.					
Remote sense compensation voltage	V	4	10	25	37.5	50	

Rise time*8	Rated load	ms	30	30	30	30	30
	No load	ms	30	30	30	30	30
Fall time*9	Rated load	ms	80	80	80	80	80
	No load	ms	1000	1000	1000	1200	1000
Transient response time*10		ms	1.5	1.5	1.5	1.5	1.5

Model		PHU 1500-10	80-340	200-140	500-60	750-40	
Line regulation*3 [0.01% of Vo_rated]	mV	150	8	20	50	75	
Load regulation*4 [0.02% of Vo_rated]	mV	300	16	40	100	150	
Ripple and noise*5	p-p*6	mV	2400	200	300	350	800
	r.m.s.*7	mV	400	16	40	70	200
Temperature coefficient	ppm / °C	100ppm/°C of rated output voltage, after a 30 minute warm-up.					
Remote sense compensation voltage	V	75	4	10	25	37.5	
Rise time*8	Rated load	ms	30	30	30	30	30
	No load	ms	30	30	30	30	30
Fall time*9	Rated load	ms	80	80	80	80	80
	No load	ms	1200	1000	1000	1000	1200
Transient response time*10		ms	1.5	1.5	1.5	1.5	1.5

Model		PHU 1000-30	1500-20	80-510	200-210	500-90	
Line regulation*3 [0.01% of Vo_rated]	mV	100	150	8	20	50	
Load regulation*4 [0.02% of Vo_rated]	mV	200	300	16	40	100	
Ripple and noise*5	p-p*6	mV	1600	2400	200	300	350
	r.m.s.*7	mV	350	400	16	40	70
Temperature coefficient	ppm / °C	100ppm/°C of rated output voltage, after a 30 minute warm-up.					
Remote sense compensation voltage	V	50	75	4	10	25	
Rise time*8	Rated load	ms	30	30	30	30	30
	No load	ms	30	30	30	30	30
Fall time*9	Rated load	ms	80	80	80	80	80
	No load	ms	1000	1200	1000	1000	1000
Transient response time*10		ms	1.5	1.5	1.5	1.5	1.5

Model		PHU 750-60	1000-45	1500-30	
Line regulation ^{*3} [0.01% of Vo _{rated}]	mV	75	100	150	
Load regulation ^{*4} [0.02% of Vo _{rated}]	mV	150	200	300	
Ripple and noise ^{*5}	p-p ^{*6}	mV	800	1600	2400
	r.m.s. ^{*7}	mV	200	350	400
Temperature coefficient	ppm / °C	100ppm/°C of rated output voltage, after a 30 minute warm-up.			
Remote sense compensation voltage	V	37.5	50	75	
Rise time ^{*8}	Rated load	ms	30	30	30
	No load	ms	30	30	30
Fall time ^{*9}	Rated load	ms	80	80	80
	No load	ms	1200	1000	1200
Transient response time ^{*10}	ms	1.5	1.5	1.5	

Constant Current Mode

Model		PHU 80-170	200-70	500-30	750-20	1000-15
Line regulation ^{*3} [0.05% of Io _{rated}]	mA	85	35	15	10	7.5
Load regulation ^{*11} [0.1% of Io _{rated}]	mA	170	70	30	20	15
Ripple and noise ^{*12}	r.m.s. ^{*7}	mA	170	50	16	8
Temperature coefficient	ppm / °C	100 ppm/°C of rated output current, after a 30 minute warm-up.				

Model		PHU 1500-10	80-340	200-140	500-60	750-40
Line regulation ^{*3} [0.05% of Io _{rated}]	mA	5	170	70	30	20
Load regulation ^{*11} [0.1% of Io _{rated}]	mA	10	340	140	60	40
Ripple and noise ^{*12}	r.m.s. ^{*7}	mA	8	340	100	32
Temperature coefficient	ppm / °C	100 ppm/°C of rated output current, after a 30 minute warm-up.				

Model		PHU 1000-30	1500-20	80-510	200-210	500-90
Line regulation ^{*3} [0.05% of Io _{rated}]	mA	15	10	255	105	45
Load regulation ^{*11} [0.1% of Io _{rated}]	mA	30	20	510	210	90
Ripple and noise ^{*12}	r.m.s. ^{*7}	mA	22	22	510	150
Temperature coefficient	ppm / °C	100 ppm/°C of rated output current, after a 30 minute warm-up.				

Model		PHU750-60	1000-45	1500-30
Line regulation ^{*3} [0.05% of Io_rated]		mA 30	22.5	15
Load regulation ^{*11} [0.1% of Io_rated]		mA 60	45	30
Ripple and noise ^{*12} r.m.s. ^{*7}		mA 48	26	26
Temperature coefficient		ppm / °C	100 ppm/°C of rated output current, after a 30 minute warm-up.	

Protection Function

Model	PHU		80-170	200-70	500-30	750-20	1000-15
Over voltage protection (OVP)	Setting range	V	5.00 V to 88.00 V	5.00 V to 220.00 V	5.00 V to 550.00 V	5.0 V to 825.0 V	5.0 V to 1100.0 V
	Setting accuracy	mV	80	200	500	750	1000
Over current protection (OCP)	Setting range	A	5.00 A to 187.00 A	5.00 A to 77.00 A	3.000 A to 33.000 A	2.000 A to 22.000 A	1.500 A to 16.500 A
	Setting accuracy	mA	340	140	60	40	30
Over power protection (OPP)	Setting range	W	100 W to 5500 W	100 W to 5500 W	100 W to 5500 W	100 W to 5500 W	100 W to 5500 W
	Setting accuracy	W	50	50	50	50	50
Over voltage limit (OVL)	Setting range	V	0.00 V to 84.00 V	0.00 V to 210.00 V	0.00 V to 525.00 V	0.0 V to 787.5 V	0.0 V to 1050.0 V
Under voltage limit (UVL)	Setting range	V	0.00 V to 84.00 V	0.00 V to 210.00 V	0.00 V to 525.00 V	0.0 V to 787.5 V	0.0 V to 1050.0 V
Over current limit (OCL)	Setting range	A	0.00 A to 178.50 A	0.00 A to 73.50 A	0.000 A to 31.500 A	0.000 A to 21.000 A	0.000 A to 15.750 A
Under current limit (UCL)	Setting range	A	0.00 A to 178.50 A	0.00 A to 73.50 A	0.000 A to 31.500 A	0.000 A to 21.000 A	0.000 A to 15.750 A

Model	PHU		1500-10	80-340	200-140	500-60	750-40
Over voltage protection (OVP)	Setting range	V	5.0 V to 1650.0 V	5.00 V to 88.00 V	5.00 V to 220.00 V	5.00 V to 550.00 V	5.0 V to 825.0 V
	Setting accuracy	mV	1500	80	200	500	750
Over current protection (OCP)	Setting range	A	1.000 A to 11.000 A	5.00 A to 374.00 A	5.00 A to 154.00 A	5.00 A to 66.00 A	4.000 A to 44.000 A
	Setting accuracy	mA	20	680	280	120	80

Over power protection (OPP)	Setting range	W	100 W to 5500 W	200 W to 11000 W	200 W to 11000 W	200 W to 11000 W	200 W to 11000 W
	Setting accuracy	W	50	100	100	100	100
Over voltage limit (OVL)	Setting range	V	0.0 V to 1575.0 V	0.00 V to 84.00 V	0.00 V to 210.00 V	0.00 V to 525.00 V	0.0 V to 787.5 V
Under voltage limit (UVL)	Setting range	V	0.0 V to 1575.0 V	0.00 V to 84.00 V	0.00 V to 210.00 V	0.00 V to 525.00 V	0.0 V to 787.5 V
Over current limit (OCL)	Setting range	A	0.000 A to 10.500 A	0.00 A to 357.00 A	0.00 A to 147.00 A	0.00 A to 63.00 A	0.000 A to 42.000 A
Under current limit (UCL)	Setting range	A	0.000 A to 10.500 A	0.00 A to 357.00 A	0.00 A to 147.00 A	0.00 A to 63.00 A	0.000 A to 42.000 A

Model	PHU		1000-30	1500-20	80-510	200-210	500-90
Over voltage protection (OVP)	Setting range	V	5.0 V to 1100.0 V	5.0 V to 1650.0 V	5.00 V to 88.00 V	5.00 V to 220.00 V	5.00 V to 550.00 V
	Setting accuracy	mV	1000	1500	80	200	500
Over current protection (OCP)	Setting range	A	3.000 A to 33.000 A	2.000 A to 22.000 A	5.00 A to 561.00 A	5.00 A to 231.00 A	5.00 A to 99.00 A
	Setting accuracy	mA	60	40	1020	420	180
Over power protection (OPP)	Setting range	W	200 W to 11000 W	200 W to 11000 W	300 W to 16500 W	300 W to 16500 W	300 W to 16500 W
	Setting accuracy	W	100	100	150	150	150
Over voltage limit (OVL)	Setting range	V	0.0 V to 1050.0 V	0.0 V to 1575.0 V	0.00 V to 84.00 V	0.00 V to 210.00 V	0.00 V to 525.00 V
Under voltage limit (UVL)	Setting range	V	0.0 V to 1050.0 V	0.0 V to 1575.0 V	0.00 V to 84.00 V	0.00 V to 210.00 V	0.00 V to 525.00 V
Over current limit (OCL)	Setting range	A	0.000 A to 31.500 A	0.000 A to 21.000 A	0.00 A to 535.50 A	0.00 A to 220.50 A	0.00 A to 94.50 A
Under current limit (UCL)	Setting range	A	0.000 A to 31.500 A	0.000 A to 21.000 A	0.00 A to 535.50 A	0.00 A to 220.50 A	0.00 A to 94.50 A

Model	PHU		750-60	1000-45	1500-30
Over voltage protection (OVP)	Setting range	V	5.0 V to 825.0 V	5.0 V to 1100.0 V	5.0 V to 1650.0 V
	Setting accuracy	mV	750	1000	1500

Over current protection (OCP)	Setting range	A	5.00 A to 66.00 A	4.5 A to 49.500 A	3 A to 33.000 A
	Setting accuracy	mA	120	90	60
Over power protection (OPP)	Setting range	W	300 W to 16500 W	300 W to 16500 W	300 W to 16500 W
	Setting accuracy	W	150	150	150
Over voltage limit (OVL)	Setting range	V	0.0 V to 787.5 V	0.0 V to 1050.0 V	0.0 V to 1575.0 V
Under voltage limit (UVL)	Setting range	V	0.0 V to 787.5 V	0.0 V to 1050.0 V	0.0 V to 1575.0 V
Over current limit (OCL)	Setting range	A	0.00 A to 63.00 A	0.000 A to 47.250 A	0.000 A to 31.500 A
Under current limit (UCL)	Setting range	A	0.00 A to 63.00 A	0.000 A to 47.250 A	0.000 A to 31.500 A

Model	PHU All models	
Power unit fail (PUF)	Operation	Turn the output off.
Incorrect sensing connection protection (SENSE)	Operation	Turn the output off.
Low AC input protection (AC-FAIL)	Operation	Turn the output off.
Shutdown (SD)	Operation	Turn the output off.
Power limit (POWER LIMIT)	Operation	Over power limit.
	Value (fixed)	Approx. 102% of rated output power

Other Function

Model	PHU	80-170	200-70	500-30	750-20	1000-15	
Voltage Slew Rate	Setting range	V/s	0.01 to 160.00	0.01 to 400.00	0.1 to 1000.0	0.1 to 1500.0	0.1 to 2000.0
	Resolution	mV	10	10	100	100	100
Current slew rate	Setting range	A/s	0.01 to 340.00	0.01 to 140.00	0.001 to 60.000	0.001 to 40.000	0.001 to 30.000
	Resolution	mA	10	10	1	1	1
Internal resistance	Setting range	Ω	0.000 to 0.471	0.000 to 2.857	0.00 to 16.67	0.00 to 37.50	0.0 to 66.7
	Resolution	m Ω	1	1	10	10	100

Model	PHU	1500-10	80-340	200-140	500-60	750-40	
Voltage Slew Rate	Setting range	V/s	0.1 to 3000.0	0.01 to 160.00	0.01 to 400.00	0.1 to 1000.0	0.1 to 1500.0
	Resolution	mV	100	10	10	100	100

Current slew rate	Setting range	A/s	0.001 to 20.000	0.1 to 680.0	0.01 to 280.00	0.01 to 120.00	0.01 to 80.00
	Resolution	mA	1	100	10	10	10
Internal resistance	Setting range	Ω	0.0 to 150.0	0.000 to 0.235	0.000 to 1.428	0.00 to 8.33	0.00 to 18.75
	Resolution	m Ω	100	1	1	10	10

Model	PHU	1000-30	1500-20	80-510	200-210	500-90	
Voltage Slew Rate	Setting range	V/s	0.1 to 2000.0	0.1 to 3000.0	0.01 to 160.00	0.01 to 400.00	0.1 to 1000.0
	Resolution	mV	100	100	10	10	100
Current slew rate	Setting range	A/s	0.001 to 60.000	0.001 to 40.000	0.1 to 1020.0	0.01 to 420.00	0.01 to 180.00
	Resolution	mA	1	1	100	10	10
Internal resistance	Setting range	Ω	0.00 to 33.33	0.0 to 75.0	0.000 to 0.157	0.00 to 0.95	0.00 to 5.56
	Resolution	m Ω	10	100	1	10	10

Model	PHU	750-60	1000-45	1500-30	
Voltage Slew Rate	Setting range	V/s	0.1 to 1500.0	0.1 to 2000.0	0.1 to 3000.0
	Resolution	mV	100	100	100
Current slew rate	Setting range	A/s	0.01 to 120.00	0.01 to 90.00	0.001 to 60.000
	Resolution	mA	10	10	1
Internal resistance	Setting range	Ω	0.00 to 12.50	0.00 to 22.22	0.0 to 50.0
	Resolution	m Ω	10	10	100

Front Panel

Model	PHU	80-170	200-70	500-30	750-20	1000-15
Display	TFT-LCD, 5", 800pt x 480pt					
Voltage accuracy [0.1% of Vo_rated]	mV	80	200	500	750	1000
Current accuracy [0.2% of Io_rated]	mA	340	140	60	40	30
Power accuracy [1% of Po_rated]	W	50	50	50	50	50
Voltage resolution	V	0.01	0.01	0.01	0.1	0.1
Current resolution	A	0.01	0.01	0.001	0.001	0.001
Power resolution	W	0.1	0.1	0.1	0.1	0.1

Model	PHU	1500-10	80-340	200-140	500-60	750-40
Display	TFT-LCD, 5", 800pt x 480pt					
Voltage accuracy [0.1% of Vo_rated]	mV	1500	80	200	500	750
Current accuracy [0.2% of Io_rated]	mA	20	680	280	120	80
Power accuracy [1% of Po_rated]	W	50	100	100	100	100
Voltage resolution	V	0.1	0.01	0.01	0.01	0.1
Current resolution	A	0.001	0.01	0.01	0.001	0.001
Power resolution	W	0.1	1	1	1	1

Model	PHU	1000-30	1500-20	80-510	200-210	500-90
Display	TFT-LCD, 5", 800pt x 480pt					
Voltage accuracy [0.1% of Vo_rated]	mV	1000	1500	80	200	500
Current accuracy [0.2% of Io_rated]	mA	60	40	1020	420	180
Power accuracy [1% of Po_rated]	W	100	100	150	150	150
Voltage resolution	V	0.1	0.1	0.01	0.01	0.01
Current resolution	A	0.001	0.001	0.01	0.01	0.01
Power resolution	W	1	1	1	1	1

Model	PHU	750-60	1000-45	1500-30
Display	TFT-LCD, 5", 800pt x 480pt			
Voltage accuracy [0.1% of Vo_rated]	mV	750	1000	1500
Current accuracy [0.2% of Io_rated]	mA	120	90	60
Power accuracy [1% of Po_rated]	W	150	150	150
Voltage resolution	V	0.1	0.1	0.1
Current resolution	A	0.001	0.001	0.001
Power resolution	W	1	1	1

Model	PHU All models
Buttons	Menu, Local, Exit, Clear, Enter, Lock, Current, Shift Output, Numeric Keypad
Rotary knob	Turn the knob to increase or decrease the value.
USB port	Type A USB connector

Programming and Measurement (Digital Interface)

Model	PHU	80-170	200-70	500-30	750-20	1000-15
Output voltage programming range	0 to 105% V	0 to 84	0 to 210	0 to 525	0 to 787.5	0 to 1050
Output current programming range	0 to 105% A	0 to 178.5	0 to 73.5	0 to 31.5	0 to 21	0 to 15.75
Output power programming range	0 to 102% W	0 to 5100	0 to 5100	0 to 5100	0 to 5100	0 to 5100
Output voltage programming accuracy [0.1% of Vo_rated]	mV	80	200	500	750	1000
Output current programming accuracy [0.2% of Io_rated]	mA	340	140	60	40	30
Output power programming accuracy [1% of Po_rated]	W	50	50	50	50	50
Output voltage programming resolution	mV	10	10	10	100	100
Output current programming resolution	mA	10	10	1	1	1
Output power programming resolution	W	0.1	0.1	0.1	0.1	0.1
Output voltage measurement accuracy [0.1% of Vo_rated]	mV	80	200	500	750	1000
Output current measurement accuracy [0.2% of Io_rated]	mA	340	140	60	40	30
Output power measurement accuracy [1% of Po_rated]	W	50	50	50	50	50
Output voltage measurement resolution	mV	10	10	10	100	100
Output current measurement resolution	mA	10	10	1	1	1
Output power measurement resolution	W	0.1	0.1	0.1	0.1	0.1
Model	PHU	1500-10	80-340	200-140	500-60	750-40
Output voltage programming range	0 to 105% V	0 to 1575	0 to 84	0 to 210	0 to 525	0 to 787.5
Output current programming range	0 to 105% A	0 to 10.5	0 to 357	0 to 147	0 to 63	0 to 42
Output power programming range	0 to 102% W	0 to 5100	0 to 10200	0 to 10200	0 to 10200	0 to 10200

Output voltage programming accuracy [0.1% of Vo_rated]	mV 1500	80	200	500	750
Output current programming accuracy [0.2% of Io_rated]	mA 20	680	280	120	80
Output power programming accuracy [1% of Po_rated]	W 50	100	100	100	100
Output voltage programming resolution	mV 100	10	10	10	100
Output current programming resolution	mA 1	10	10	1	1
Output power programming resolution	W 0.1	1	1	1	1
Output voltage measurement accuracy [0.1% of Vo_rated]	mV 1500	80	200	500	750
Output current measurement accuracy [0.2% of Io_rated]	mA 20	680	280	120	80
Output power measurement accuracy [1% of Po_rated]	W 50	100	100	100	100
Output voltage measurement resolution	mV 100	10	10	10	100
Output current measurement resolution	mA 1	10	10	1	1
Output power measurement resolution	W 0.1	1	1	1	1

Model	PHU	1000-30	1500-20	80-510	200-210	500-90
Output voltage programming range	0 to 105% V	0 to 1050	0 to 1575	0 to 84	0 to 210	0 to 525
Output current programming range	0 to 105% A	0 to 31.5	0 to 21	0 to 535.5	0 to 220.5	0 to 94.5
Output power programming range	0 to 102% W	0 to 10200	0 to 10200	0 to 15300	0 to 15300	0 to 15300
Output voltage programming accuracy [0.1% of Vo_rated]	mV 1000	1500	80	200	500	
Output current programming accuracy [0.2% of Io_rated]	mA 60	40	1020	420	180	
Output power programming accuracy [1% of Po_rated]	W 100	100	150	150	150	
Output voltage programming resolution	mV 100	100	10	10	10	

Output current programming resolution	mA	1	1	10	10	10
Output power programming resolution	W	1	1	1	1	1
Output voltage measurement accuracy [0.1% of Vo_rated]	mV	1000	1500	80	200	500
Output current measurement accuracy [0.2% of Io_rated]	mA	60	40	1020	420	180
Output power measurement accuracy [1% of Po_rated]	W	100	100	150	150	150
Output voltage measurement resolution	mV	100	100	10	10	10
Output current measurement resolution	mA	1	1	10	10	10
Output power measurement resolution	W	1	1	1	1	1

Model	PHU	1000-30	1500-20	80-510
Output voltage programming range	0 to 105% V	0 to 787.5	0 to 1050	0 to 1575
Output current programming range	0 to 105% A	0 to 63	0 to 47.25	0 to 31.5
Output power programming range	0 to 102% W	0 to 15300	0 to 15300	0 to 15300
Output voltage programming accuracy [0.1% of Vo_rated]	mV	750	1000	1500
Output current programming accuracy [0.2% of Io_rated]	mA	120	90	60
Output power programming accuracy [1% of Po_rated]	W	150	150	150
Output voltage programming resolution	mV	100	100	100
Output current programming resolution	mA	1	1	1
Output power programming resolution	W	1	1	1
Output voltage measurement accuracy [0.1% of Vo_rated]	mV	750	1000	1500
Output current measurement accuracy [0.2% of Io_rated]	mA	120	90	60

Output power measurement accuracy [1% of Po_rated]	W	150	150	150
Output voltage measurement resolution	mV	100	100	100
Output current measurement resolution	mA	1	1	1
Output power measurement resolution	W	1	1	1

Input Characteristics for PHU-C series (for 5kW models)

Model	PHU-C models			
Nominal input rating	3-Phase, 200 V models: 180 Vac to 265 Vac (Covers 200/ 230 Vac)			
Input frequency range	47 Hz to 63 Hz			
Maximum input current	200Vac	A	32 A (L1, L2)	
Inrush current	200Vac	A	Less than 50 A	
Maximum input power	VA 6000			
Power factor	Rated Power	> 0.95		
Efficiency*14	200 Vac	%	86 to 94	
Hold-up time	10 ms or greater			

Input Characteristics for PHU-C series (for 10kW models)

Model	PHU-C models			
Nominal input rating	3-Phase, 200 V models: 180 Vac to 265 Vac (Covers 200/ 230 Vac)			
Input frequency range	47 Hz to 63 Hz			
Maximum input current	200Vac	A	56 A (L1), 32 A (L2, L3)	
Inrush current	200Vac	A	Less than 100 A	
Maximum input power	VA 12000			
Power factor	Rated Power	> 0.95		
Efficiency*14	200 Vac	%	86 to 94	
Hold-up time	10 ms or greater			

Input Characteristics for PHU-C series (for 15kW models)

Model	PHU-C models			
Nominal input rating	3-Phase, 200 V models: 180 Vac to 265 Vac (Covers 200/ 230 Vac)			
Input frequency range	47 Hz to 63 Hz			
Maximum input current	200Vac	A	56 A (L1, L2, L3)	
Inrush current	200Vac	A	Less than 100 A	
Maximum input power	VA 18000			
Power factor	Rated Power	> 0.95		

Efficiency*14	200 Vac	%	86 to 94
Hold-up time			10 ms or greater

Input Characteristics for PHU-D series (for 5kW models)

Model	PHU-D models		
Nominal input rating	3-Phase, 400 V models: 342 Vac to 528 Vac (Covers 380/400/415/440/460/480 Vac)		
Input frequency range	47 Hz to 63 Hz		
Maximum input current	400Vac	A	16 A (L1, L2)
Inrush current	400Vac	A	Less than 25 A
Maximum input power	VA 6000		
Power factor	Rated Power	> 0.95	
Efficiency*14	400 Vac	%	87 to 94
Hold-up time			10 ms or greater

Input Characteristics for PHU-D series (for 10kW models)

Model	PHU-D models		
Nominal input rating	3-Phase, 400 V models: 342 Vac to 528 Vac (Covers 380/400/415/440/460/480 Vac)		
Input frequency range	47 Hz to 63 Hz		
Maximum input current	400Vac	A	28 A (L1), 16 A (L2, L3)
Inrush current	400Vac	A	Less than 50 A
Maximum input power	VA 12000		
Power factor	Rated Power	> 0.95	
Efficiency*14	400 Vac	%	87 to 94
Hold-up time			10 ms or greater

Input Characteristics for PHU-D series (for 15kW models)

Model	PHU-D models		
Nominal input rating	3-Phase, 400 V models: 342 Vac to 528 Vac (Covers 380/400/415/440/460/480 Vac)		
Input frequency range	47 Hz to 63 Hz		
Maximum input current	400Vac	A	28 A (L1, L2, L3)
Inrush current	400Vac	A	Less than 50 A
Maximum input power	VA 18000		
Power factor	Rated Power	> 0.95	
Efficiency*14	400 Vac	%	87 to 94
Hold-up time			10 ms or greater

Interface Capabilities

Model	PHU All models
USB	Type A: Host, Type B: Slave, Speed: 1.1/2.0, USB Class: CDC (Communications Device Class)
LAN	MAC Address, DNS IP Address, User Password, Gateway IP Address, Instrument IP Address, Subnet Mask
Isolated Analog Control Interface	Vset/ Iset = 0 V to 5 V or 0 V to 10 V Vmon/ Imon = 0 V to 5 V or 0 V to 10 V
Factory Optional	RS-232&485 or GPIB or CAN Bus or DeviceNet or Isolated Digital I/O

Isolated Analog Control Interface

Model	PHU All models
Vout voltage programming	0 to 100%, 0 V to 5 V Accuracy: $\pm 1\%$ of rated Vout, or 0–10 V Accuracy: $\pm 1\%$ of rated Vout
Iout voltage programming	0 to 100%, 0 V to 5 V Accuracy: $\pm 1\%$ of rated Iout, or 0 V to 10 V Accuracy: $\pm 1\%$ of rated Iout
Pout voltage programming	0 to 100%, 0 V to 5 V Accuracy: $\pm 1\%$ of rated Pout, or 0 V to 10 V Accuracy: $\pm 1\%$ of rated Pout
Internal resistance voltage programming	0 to 100%, 0 V to 5 V Accuracy: $\pm 1\%$ of maximum Rint, or 0 V to 10 V Accuracy: $\pm 1\%$ of maximum Rint
Output voltage monitor	0 V to 5 V or 0 V to 10 V, Accuracy: $\pm 1\%$.
Output current monitor	0 to 5 V or 0 to 10 V, Accuracy: $\pm 1\%$.
Reference voltage	Voltage reference for 0 V to 5 V or 0 V to 10 V.
Alarm Input	Turn off the PHU output with a High (4.5 V to 5 V)
Output on/off control	Possible logic selections: Turn the output on using a LOW (0 V to 0.5 V) or short-circuit, turn the output off using a HIGH (4.5 V to 5 V) or open-circuit. Turn the output on using a HIGH (4.5 V to 5 V) or open-circuit, turn the output off using a LOW (0 V to 0.5 V) or short-circuit.
Alarm clear control	Clear alarms with a High (4.5V to 5V)
CV/ CC/ CP/ ALM/ PWR ON/ OUT ON indicator	Photocoupler open collector output; Maximum voltage 30 V, maximum sink current 8 mA.

Environment Conditions

Model	PHU All models
Operating temperature	0°C to 50°C
Storage temperature	-25°C to 70°C
Operating humidity	20% to 85% RH; No condensation

Storage humidity	90% RH or less; No condensation
Altitude	Maximum 2000m

General Specifications

Model	PHU 5kW models		10kW models	15kW models	
Weight	main unit only	kg	Less than 21 kg	Less than 30.5 kg	Less than 40 kg

Model	PHU All models		
Weight	main unit only	kg	Less than 40 kg
Dimensions (W×H×D)	mm	442 mm × 130 mm × 675 mm	
Cooling	Forced air cooling by internal fan		
EMC	Complies with the European EMC directive 89/336/EEC for Class A test and measurement products.		
Safety	Complies with the European Low Voltage Directive 73/23/EEC and carries the CE-marking.		
Withstand voltage	Chassis and output terminal; chassis and AC input; AC input and output terminal: AC 1500 V or DC 2130 V 1 minute		
Insulation resistance	Chassis and output terminal; chassis and AC input; AC input and output terminal: 100 MΩ or more (DC 500 V)		

Notes:

- *1 Minimum voltage is guaranteed to maximum 0.2% of the rated output voltage.
- *2 Minimum current is guaranteed to maximum 0.4% of the rated output current.
- *3 At 180 Vac to 265 Vac or 342 Vac to 528 Vac, constant load.
- *4 From No-load to Full-load, constant input voltage. Measured at the sensing point in Remote Sense.
- *5 For 80 V, 200 V models: Measure with JEITA RC-9131B (1:1) probe. For 500 V, 750 V, 1000 V and 1500 V models: Measured with (100:1) probe
- *6 Measurement frequency bandwidth is 10Hz to 20MHz.
- *7 Measurement frequency bandwidth is 5Hz to 1MHz.
- *8 From 10% to 90% of rated output voltage, with rated resistive load.
- *9 From 90% to 10% of rated output voltage, with rated resistive load.
- *10 Time for output voltage to recover within 1% of its rated output for a load change from 10 to 90% of its rated output current. Voltage set point from 10% to 100% of rated output.
- *11 For load voltage change, equal to the unit voltage rating, constant input voltage.
- *12 The ripple is measured at 20% to 100% output voltage and full output current.
- *13 For output power change from 10% to 90%, constant input voltage.
- *14 At rated output power.

PHU Dimensions

The PHU models are available in two sizes, depending on the output voltage, with the difference being the size of the output voltage terminals.

PHU-HV (PHU 500, 750, 1000, 1500)

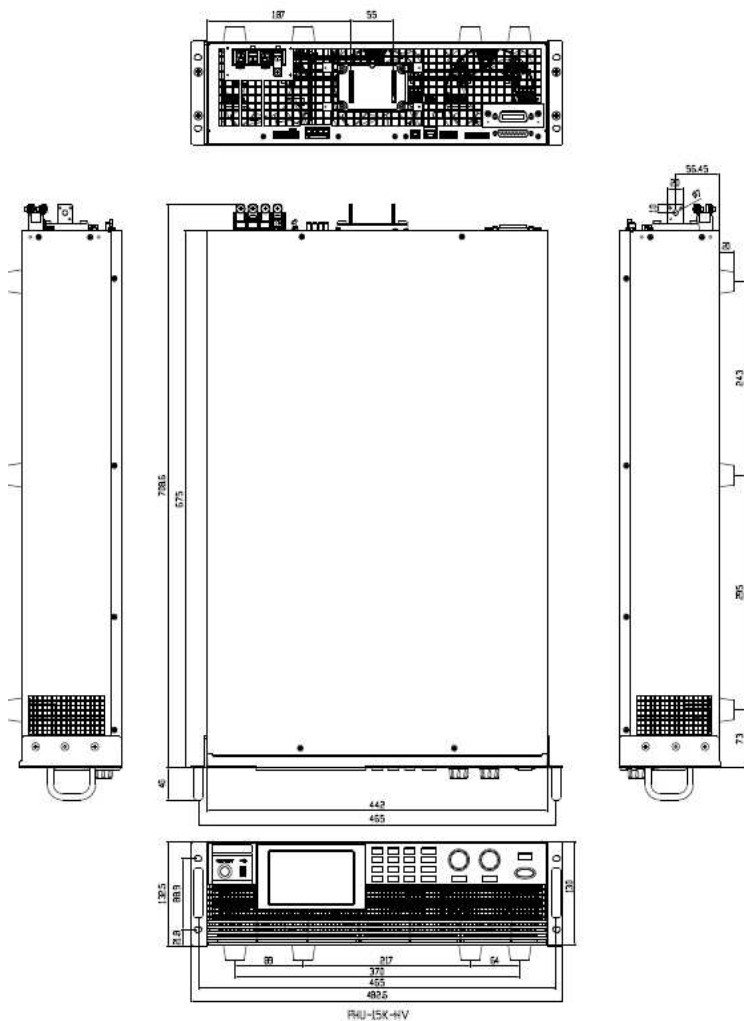

PHU-LV (PHU 80, 200)

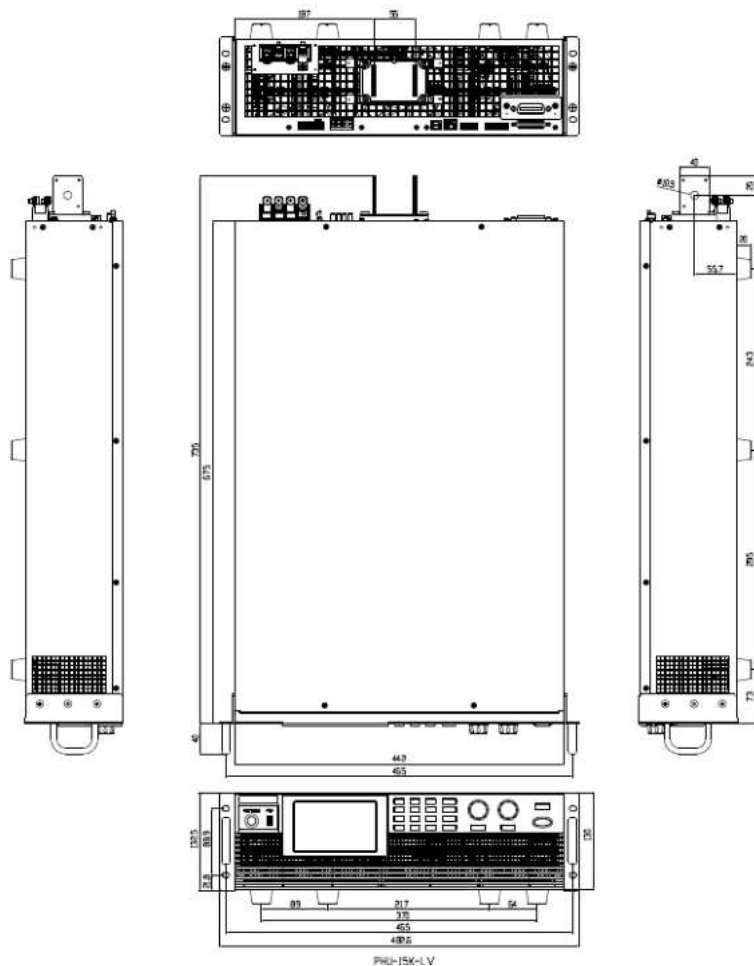

Certificate Of Compliance

We

GOOD WILL INSTRUMENT CO., LTD.

declare that the CE marking mentioned product

satisfies all the technical relations application to the product within the scope of council:

Directive: EMC; LVD; WEEE; RoHS

The product is in conformity with the following standards or other normative documents:

© EMC	
EN 61326-1	Electrical equipment for measurement, control and laboratory use -- EMC requirements
Conducted & Radiated Emission EN 55011 / EN 55032	Electrical Fast Transients EN 61000-4-4
Current Harmonics EN 61000-3-2 / EN 61000-3-12	Surge Immunity EN 61000-4-5
Voltage Fluctuations EN 61000-3-3 / EN 61000-3-11	Conducted Susceptibility EN 61000-4-6
Electrostatic Discharge EN 61000-4-2	Power Frequency Magnetic Field EN 61000-4-8
Radiated Immunity EN 61000-4-3	Voltage Dip/ Interruption EN 61000-4-11 / EN 61000-4-34
© Safety	
EN 61010-1 :	Safety requirements for electrical equipment for measurement, control, and laboratory use - Part 1: General requirements

GOODWILL INSTRUMENT CO., LTD.

No. 7-1, Jhongsing Road, Tucheng District, New Taipei City 236, Taiwan

Tel: [+886-2-2268-0389](tel:+886-2-2268-0389)

Fax: [+886-2-2268-0639](tel:+886-2-2268-0639)

Web: <http://www.gwinstek.com>

Email: marketing@goodwill.com.tw

GOODWILL INSTRUMENT (SUZHOU) CO., LTD.

No. 521, Zhujiang Road, Snd, Suzhou Jiangsu 215011, China

Tel: [+86-512-6661-7177](tel:+86-512-6661-7177)

Fax: [+86-512-6661-7277](tel:+86-512-6661-7277)

Web: <http://www.instek.com.cn>

Email: marketing@instek.com.cn

GOODWILL INSTRUMENT EURO B.V.

De Run 5427A, 5504DG Veldhoven, The Netherlands

Tel: [+31-\(0\)40-2557790](tel:+31-(0)40-2557790)

Fax: [+31-\(0\)40-2541194](tel:+31-(0)40-2541194)

Email: sales@gw-instek.eu