

# HAKKO FT-700

TIP POLISHER

## Instruction Manual

Thank you for purchasing the HAKKO FT-700 tip polisher.  
Please read this manual before operating the HAKKO FT-700.  
Keep this manual readily accessible for reference.

### 1. PACKING LIST AND PART NAMES

Please check to make sure that all items listed below are included in the package.

- HAKKO FT-700 tip polisher.....1
- HAKKO FS-100 paste .....1

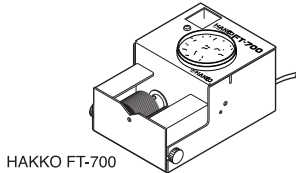

### 2. SPECIFICATIONS

|                     |                              |
|---------------------|------------------------------|
| Name                | HAKKO FT-700                 |
| Power consumption   | 4.5 W                        |
| External dimensions | 70 (W) × 54 (H) × 101 (D) mm |
| Weight              | 0.65 kg                      |

**NOTE:**  
Specifications and design are subject to change without notice.

### 3. WARNINGS, CAUTIONS AND NOTES

#### ⚠ WARNING

Warnings, cautions and notes are placed at critical points in this manual to direct the operator's attention to significant items. They are defined as follows:

**⚠ WARNING :** Failure to comply with a WARNING may result in serious injury or death.

**⚠ CAUTION :** Failure to comply with a CAUTION may result in injury to the operator, or damage to the items involved.

**NOTE :** A NOTE indicates a procedure or point that is important to the process being described.

**EXAMPLE :** An EXAMPLE is given to demonstrate a particular procedure point or process.

To prevent accidents or damage to the HAKKO FT-700, be sure to observe the following:

#### ⚠ CAUTION

- Do not modify the HAKKO FT-700.
- Use only genuine HAKKO replacement parts.
- Do not wet the unit or use the unit with wet hand.
- Remove power cord by holding the plug – not the wires.
- Take care not to pinch fingers.
- Turn the power off when not in use, or left unattended.
- Turn the power off when changing parts or storing the HAKKO FT-700.
- While using the HAKKO FT-700, don't do anything which may cause bodily harm or physical damage.

### 4. INITIAL SETUP

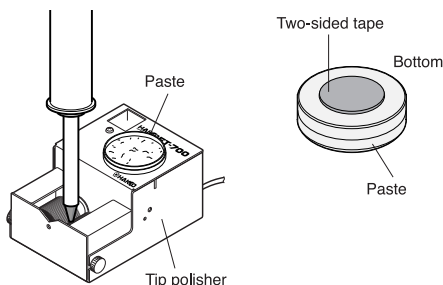

### 5. OPERATION

- ① Turn on the power switch.
- ② Touch the blackened tip to the polishing brushes to remove the oxide film.

**NOTE:**  
A tip temperature of 300°C (512°F) is the most suitable for cleaning.

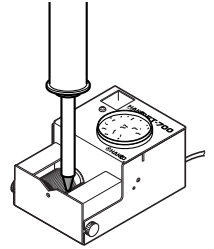

- ③ Inspect the tip to see that the oxide film has been removed by the HAKKO FT-700.

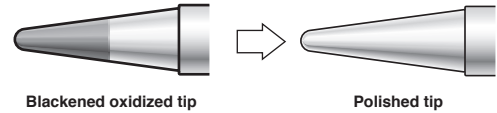

- ④ If all of the oxide film has been removed by the HAKKO FT-700, promptly re-tin the tip with the solder wire currently being used. If there is any oxide film remaining, proceed to the next step.



- ⑤ If all of the oxide film could not be removed, touch the tip to the HAKKO FS-100 paste.



- ⑥ Touch the tip to the polishing brushes again to remove any remaining oxide film and any paste residue.

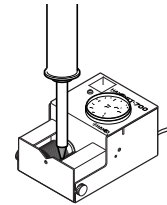

- ⑦ Promptly re-tin the tip with the solder wire currently being used.

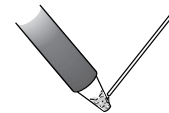

**NOTE:**  
Even after being cleaned by the HAKKO FT-700, a tip temperature of 400°C (752°F) or higher will blacken and oxidize the tip quickly unless it is re-tinned promptly after cleaning.

**NOTE:**  
The HAKKO FS-100 has more flux than typical flux cored solder. To prevent flux residue from coming into contact with the P.W.B. after the HAKKO FS-100 is used, touch the tip to the polishing brushes of the HAKKO FT-700 to remove any remaining residue on the tip and re-tin the tip using the solder wire currently being used.

### 6. PARTS LIST

| Item No. | Part No. | Part Name       | Specifications |
|----------|----------|-----------------|----------------|
| ①        | B3052    | Polishing brush | Set of 2       |
| ②        | FS100-01 | Paste           |                |

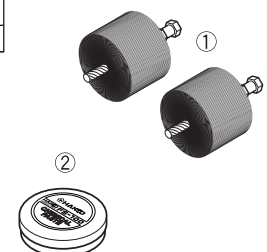



**HAKKO CORPORATION**

**HEAD OFFICE**

4-5, SHIOKUSA 2-CHOME, NANIWA-KU, OSAKA, 556-0024 JAPAN

TEL:+81-6-6561-3225 FAX:+81-6-6561-8466

<http://www.hakko.com/> E-mail:sales@hakko.com

**AMERICAN HAKKO PRODUCTS, INC.**

28920 N. AVENUE WILLIAMS VALENCIA CA 91355, U.S.A.

TEL: (661) 294-0090 FAX: (661) 294-0096

Toll Free (800)88-HAKKO <http://www.hakkousa.com>  
4 2 5 5 6

## **IMPORTANT SAFETY INSTRUCTIONS**

**WARNING**—When using electric appliances, basic precautions should always be followed, including the following.

**Read all the instructions before using the appliance.**

- a) To reduce the risk of injury, close supervision is necessary when an appliance is used near children.
- b) Do not contact moving parts.
- c) Only use attachments recommended or sold by the manufacture.
- d) Do not use outdoors.
- e) For a cord-connected appliance.
  - Do not unplug by pulling on cord. To unplug, grasp the plug, not the cord.
  - Unplug from outlet when not in use and before servicing or cleaning.
  - Do not operate any appliance with a damaged cord or plug ,or after the appliance malfunctions or is dropped or damaged in any manner. Return appliance to the nearest authorized service facility for examination, repair, or electrical or mechanical adjustment.
- f) To reduce the risk of electrical shock, do not put FT-700 in water or other liquid. Do not place or store appliance where it can fall or be pulled into a tub or sink.
- g) Connect to a properly grounded outlet only. See Grounding Instructions.

## **SAVE THESE INSTRUCTIONS**

### **INSTALLATION INSTRUCTIONS**

#### **GROUNDING INSTRUCTIONS**

This appliance must be grounded. In the event of malfunction or breakdown, grounding provides a path of least resistance for electric current to reduce the risk of electric shock. This appliance is equipped with a cord having an equipment-grounding conductor and a grounding plug. The plug must be plugged into an appropriate outlet that is properly installed and grounded in accordance with all local codes and ordinances.

**DANGER** – Improper connection of the equipment-grounding conductor can result in a risk of electric shock. The conductor with insulation having an outer surface that is green with or without yellow stripes is the equipment-grounding conductor. If repair or replacement of the cord or plug is necessary, do not connect the equipment-grounding conductor to a live terminal. Check with a qualified electrician or serviceman if the grounding instructions are not completely understood, or if in doubt as to whether the appliance is properly grounded. Do not modify the plug provided with the appliance—if it will not fit the outlet, have a proper outlet installed by a qualified electrician.

For grounded, cord-connected appliances rated less than 15 A and intended for use on a nominal 120 V supply circuit:

This appliance is for use on a nominal 120 V circuit, and has a grounding plug that looks like the plug illustrated below. A temporary adaptor, which looks like the adaptor illustrated in sketches B and C, may be used to connect this plug to a 2-pole receptacle as shown in sketch B if a properly grounded outlet is not available. The temporary adaptor should be used only until a properly grounded outlet can be installed by a qualified electrician. The green colored rigid ear, lug, and the like, extending from the adaptor must be connected to a permanent ground such as a properly grounded outlet box cover. Whenever the adaptor is used, it must be held in place by the metal screw.

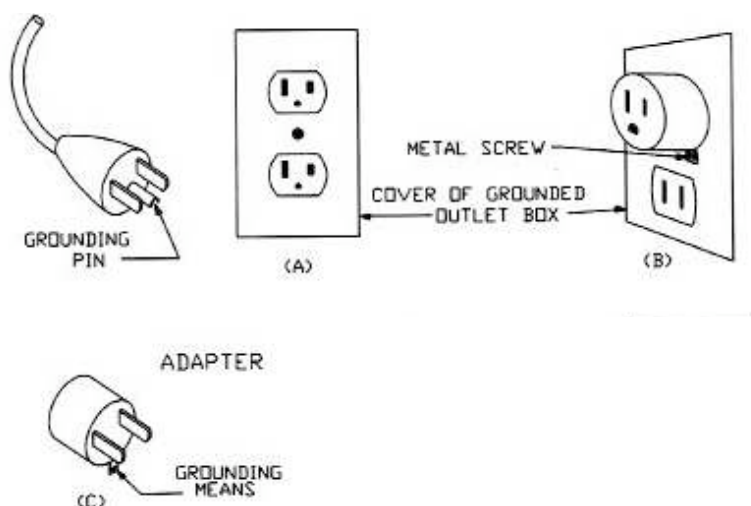

A qualified electrician should be consulted if there is any doubt as to whether an outlet box is properly grounded.