



RIGOL

# MHO/DHO5000 Series

Digital Oscilloscope

User Guide

Nov.2024



## **Guaranty and Declaration**

### **Copyright**

© 2024 RIGOL TECHNOLOGIES CO., LTD. All Rights Reserved.

### **Trademark Information**

RIGOL® is the trademark of RIGOL TECHNOLOGIES CO., LTD.

### **Notices**

- RIGOL products are covered by P.R.C. and foreign patents, issued and pending.
- RIGOL reserves the right to modify or change parts of or all the specifications and pricing policies at the company's sole decision.
- Information in this publication replaces all previously released materials.
- Information in this publication is subject to change without notice.
- RIGOL shall not be liable for either incidental or consequential losses in connection with the furnishing, use, or performance of this manual, as well as any information contained.
- Any part of this document is forbidden to be copied, photocopied, or rearranged without prior written approval of RIGOL.

### **Product Certification**

RIGOL guarantees that this product conforms to the national and industrial standards in China as well as the ISO9001:2015 standard and the ISO14001:2015 standard. Other international standard conformance certifications are in progress.

### **Contact Us**

If you have any problem or requirement when using our products or this manual, please contact RIGOL.

E-mail: [service@rigol.com](mailto:service@rigol.com)

Website: <http://www.rigol.com>

| Section | Description                         | Page |
|---------|-------------------------------------|------|
|         | List of Figures.....                | IX   |
|         | List of Tables.....                 | XVI  |
| 1       | Safety Requirement .....            | 1    |
| 1.1     | General Safety Summary .....        | 1    |
| 1.2     | Safety Notices and Symbols .....    | 3    |
| 1.3     | Measurement Category .....          | 3    |
| 1.4     | Ventilation Requirement .....       | 4    |
| 1.5     | Working Environment .....           | 4    |
| 1.6     | Care and Cleaning .....             | 6    |
| 1.7     | Environmental Considerations .....  | 6    |
| 2       | Product Features .....              | 8    |
| 3       | Document Overview .....             | 10   |
| 4       | Quick Start .....                   | 13   |
| 4.1     | General Inspection .....            | 13   |
| 4.2     | Product Appearance .....            | 13   |
| 4.3     | Appearance and Dimensions .....     | 15   |
| 4.4     | To Prepare for Use .....            | 15   |
| 4.4.1   | To Adjust the Supporting Legs ..... | 15   |
| 4.4.2   | To Connect to AC Power .....        | 16   |
| 4.4.3   | Turn-on Checkout .....              | 17   |
| 4.4.4   | To Replace the Fuse .....           | 17   |
| 4.4.5   | To Set the System Language .....    | 18   |
| 4.4.6   | To Connect the Probe .....          | 18   |
| 4.4.7   | Function Inspection .....           | 21   |
| 4.4.8   | Probe Compensation .....            | 23   |
| 4.5     | Product Overview .....              | 23   |
| 4.5.1   | Front Panel Overview .....          | 23   |
| 4.5.2   | Front Panel Function Overview ..... | 25   |
| 4.5.3   | Rear Panel Overview .....           | 31   |
| 4.5.4   | User Interface Overview .....       | 33   |
| 4.6     | Touch Screen Gestures .....         | 36   |
| 4.6.1   | Tap .....                           | 36   |
| 4.6.2   | Pinch&Stretch .....                 | 36   |

|          |  |           |
|----------|--|-----------|
| 4.6.3    | Drag   | 37        |
| 4.6.4    | Rectangle Drawing  | 38        |
| 4.7      | Parameter Setting Method                                   | 40        |
| 4.8      | To Use the Security Lock                                   | 44        |
| 4.9      | To Use the Built-in Help System                            | 44        |
| 4.10     | To View the Option Information and the Option Installation | 44        |
| <b>5</b> | <b>Vertical System</b>                                     | <b>46</b> |
| 5.1      | To Enable or Disable the Analog Channel                    | 46        |
| 5.2      | To Adjust the Vertical Scale                               | 48        |
| 5.3      | To Adjust the Vertical Offset                              | 49        |
| 5.4      | Channel Coupling   | 50        |
| 5.5      | Bandwidth Limit  | 50        |
| 5.6      | Input Impedance  | 51        |
| 5.7      | Waveform Invert  | 52        |
| 5.8      | Probe  | 53        |
| 5.9      | Amplitude Unit   | 57        |
| 5.10     | Bias   | 57        |
| 5.11     | Channel Delay  | 58        |
| 5.12     | Channel Label  | 58        |
| <b>6</b> | <b>Horizontal System</b>                                   | <b>59</b> |
| 6.1      | To Adjust the Horizontal Time Base                         | 59        |
| 6.2      | To Adjust the Horizontal Position                          | 60        |
| 6.3      | Zoom Mode (Delayed Sweep)                                  | 61        |
| <b>7</b> | <b>Acquisition System</b>                                  | <b>63</b> |
| 7.1      | Acquisition Mode   | 63        |
| 7.2      | Sampling Mode  | 64        |
| 7.3      | Sample Rate  | 65        |
| 7.4      | Memory Depth   | 66        |
| 7.5      | Horizontal Expansion                                       | 67        |
| 7.6      | Roll Mode  | 68        |
| 7.7      | XY Mode  | 69        |
| <b>8</b> | <b>To Trigger the Oscilloscope</b>                         | <b>72</b> |
| 8.1      | Trigger Source   | 73        |
| 8.2      | Trigger Level  | 73        |
| 8.3      | Trigger Mode   | 74        |
| 8.4      | Trigger Coupling   | 76        |
| 8.5      | Trigger Holdoff  | 76        |

|        |   |     |
|--------|---|-----|
| 8.6    | Noise Rejection                                 | 77  |
| 8.7    | Trigger Type                                    | 77  |
| 8.7.1  | Edge Trigger                                    | 77  |
| 8.7.2  | Pulse Trigger                                   | 78  |
| 8.7.3  | Slope Trigger                                   | 81  |
| 8.7.4  | Video Trigger                                   | 84  |
| 8.7.5  | Pattern Trigger                                 | 86  |
| 8.7.6  | Duration Trigger                                | 88  |
| 8.7.7  | Timeout Trigger                                 | 91  |
| 8.7.8  | Runt Trigger                                    | 93  |
| 8.7.9  | Window Trigger                                  | 95  |
| 8.7.10 | Delay Trigger                                   | 97  |
| 8.7.11 | Setup/Hold Trigger                              | 100 |
| 8.7.12 | Nth Edge Trigger                                | 102 |
| 8.7.13 | RS232 Trigger                                   | 104 |
| 8.7.14 | I2C Trigger                                     | 106 |
| 8.7.15 | SPI Trigger                                     | 110 |
| 8.7.16 | CAN Trigger (Option)                            | 113 |
| 8.7.17 | FlexRay Trigger (Option)                        | 116 |
| 8.7.18 | LIN Trigger (Option)                            | 118 |
| 8.7.19 | I2S Trigger (Option)                            | 120 |
| 8.7.20 | MIL-STD-1553 Trigger (Option)                   | 124 |
| 8.8    | Zone Trigger                                    | 127 |
| 8.9    | Trigger Output Connector                        | 129 |
| 9      | Math Operation                                  | 130 |
| 9.1    | Arithmetic Operation                            | 132 |
| 9.2    | Function Operation                              | 133 |
| 9.3    | FFT Operation                                   | 135 |
| 9.4    | Logic Operation                                 | 139 |
| 9.5    | Digital Filter                                  | 142 |
| 9.6    | Parameter Settings of the Math Operation Result | 144 |
| 10     | Measurements                                    | 147 |
| 10.1   | Measurement Parameter                           | 147 |
| 10.1.1 | Time Parameters                                 | 147 |
| 10.1.2 | Count Values                                    | 148 |
| 10.1.3 | Delay and Phase Parameters                      | 150 |
| 10.1.4 | Voltage Parameters                              | 151 |

|  |            |
|--|------------|
| 10.1.5 Other Parameters .....                                    | 153        |
| 10.2 To Select the Measurement Item .....                        | 153        |
| 10.3 Measurement Settings .....                                  | 154        |
| 10.4 Statistical Measurement Results .....                       | 157        |
| 10.5 To Remove the Measurement Results .....                     | 158        |
| 10.6 Auto Measurement .....                                      | 159        |
| 10.7 Cursor Measurements .....                                   | 160        |
| 10.7.1 Manual Mode .....   | 162        |
| 10.7.2 Track Mode .....  | 164        |
| 10.7.3 XY Mode .....   | 167        |
| <b>11 Digital Voltmeter (DVM) and Frequency Counter .....</b>    | <b>169</b> |
| 11.1 Digital Voltmeter (DVM) .....                               | 169        |
| 11.1.1 Measurement Settings .....                                | 169        |
| 11.1.2 To Remove the Measurement .....                           | 171        |
| 11.2 Frequency Counter .....                                     | 171        |
| 11.2.1 Measurement Settings .....                                | 172        |
| 11.2.2 To Reset Statistics .....                                 | 173        |
| <b>12 Digital Channels (Available Only for MHO Series) .....</b> | <b>174</b> |
| 12.1 Basic Settings .....  | 174        |
| 12.1.1 To Enable or Disable the Digital Channel .....            | 175        |
| 12.1.2 To Set the Label .....                                    | 175        |
| 12.1.3 To Select the Digital Channel .....                       | 176        |
| 12.1.4 To Set the Threshold .....                                | 176        |
| 12.2 Other Settings .....  | 176        |
| 12.2.1 To Set the Waveform Size .....                            | 177        |
| 12.2.2 To Set the Channel Sequence .....                         | 177        |
| 12.2.3 Sticky Display of the Waveform .....                      | 177        |
| 12.2.4 To Set the Probe Delay .....                              | 178        |
| <b>13 Histogram Analysis .....</b>                               | <b>179</b> |
| 13.1 To Enable or Disable the Histogram .....                    | 179        |
| 13.2 To Select the Histogram Type .....                          | 180        |
| 13.3 To Select the Histogram Source .....                        | 180        |
| 13.4 To Set the Histogram Height .....                           | 181        |
| 13.5 To Set the Histogram Range .....                            | 181        |
| 13.6 Histogram Analysis Results .....                            | 181        |
| 13.7 To Remove the Measurement .....                             | 182        |
| 13.8 To Clear Statistics .....                                   | 182        |

|   |            |
|---|------------|
| <b>14 Function/Arbitrary Waveform Generator (Available Only for MHO5054/5104)</b> | <b>183</b> |
| 14.1 To Output Basic Waveforms  | 184        |
| 14.1.1 Sine   | 184        |
| 14.1.2 Square   | 186        |
| 14.1.3 Ramp   | 186        |
| 14.1.4 Pulse  | 187        |
| 14.1.5 Noise  | 187        |
| 14.1.6 DC   | 188        |
| 14.1.7 Exp.Rise   | 188        |
| 14.1.8 Exp.Fall   | 188        |
| 14.1.9 ECG1   | 189        |
| 14.1.10 Gauss   | 189        |
| 14.1.11 Lorentz   | 190        |
| 14.1.12 Haversine   | 191        |
| 14.1.13 Sinc  | 191        |
| 14.2 Modulation   | 192        |
| 14.2.1 AM   | 193        |
| 14.2.2 FM   | 194        |
| 14.2.3 PM   | 196        |
| <b>15 Bode Plot (Available Only for MHO5054/5104)</b>                             | <b>198</b> |
| 15.1 Basic Setting  | 199        |
| 15.1.1 To Enable or Disable the Bode Plot Function                                | 199        |
| 15.1.2 To Start or Stop the Operation   | 199        |
| 15.1.3 To Set the Input/Output Source   | 199        |
| 15.1.4 To Set the Sweep Signal  | 200        |
| 15.1.5 To Set the Display Type  | 200        |
| 15.1.6 To View the Connection Diagram   | 202        |
| 15.2 Ampl/Freq Setting  | 202        |
| 15.3 To Store and Load  | 203        |
| <b>16 Power Analysis (Option)</b>   | <b>204</b> |
| 16.1 Power Quality  | 204        |
| 16.2 Ripple   | 207        |
| <b>17 Reference Waveform</b>  | <b>209</b> |
| 17.1 To Enable the Ref Function   | 209        |
| 17.2 To Set the Reference Waveform  | 209        |
| 17.3 To Set the Ref Waveform Display  | 210        |

|           |   |            |
|-----------|---|------------|
| 17.4      | Export and Import Operation                               | 211        |
| <b>18</b> | <b>Pass/Fail Test</b>                                     | <b>213</b> |
| 18.1      | To Start or Stop the Pass/Fail Test Operation             | 213        |
| 18.2      | To Select the Source                                      | 214        |
| 18.3      | To Set the Test Mask                                      | 214        |
| 18.4      | To Set the Output Form of the Test Results                | 215        |
| 18.5      | To Start or Stop the Pass/Fail Test Operation             | 216        |
| 18.6      | To Display the Statistics Information of the Test Results | 217        |
| <b>19</b> | <b>Protocol Decoding</b>                                  | <b>219</b> |
| 19.1      | Parallel Decoding   | 219        |
| 19.1.1    | Clock Setting (CLK)                                       | 220        |
| 19.1.2    | Bus Setting   | 221        |
| 19.1.3    | Display-related Setting                                   | 223        |
| 19.1.4    | Event Table   | 224        |
| 19.2      | RS232 Decoding  | 225        |
| 19.2.1    | Source Setting  | 226        |
| 19.2.2    | To Set Data Package                                       | 227        |
| 19.2.3    | Display-related Setting                                   | 228        |
| 19.2.4    | Event Table   | 228        |
| 19.3      | I2C Decoding  | 229        |
| 19.3.1    | Source Setting  | 230        |
| 19.3.2    | Display-related Setting                                   | 231        |
| 19.3.3    | Event Table   | 232        |
| 19.4      | SPI Decoding  | 233        |
| 19.4.1    | Source Setting  | 234        |
| 19.4.2    | To Set the Mode and Data                                  | 235        |
| 19.4.3    | Display-related Setting                                   | 236        |
| 19.4.4    | Event Table   | 237        |
| 19.5      | CAN Decoding (Option)                                     | 238        |
| 19.5.1    | Signal Configuration                                      | 239        |
| 19.5.2    | Display-related Setting                                   | 240        |
| 19.5.3    | Event Table   | 241        |
| 19.6      | LIN Decoding (Option)                                     | 242        |
| 19.6.1    | Signal Configuration                                      | 243        |
| 19.6.2    | Display-related Setting                                   | 244        |
| 19.6.3    | Event Table   | 244        |
| 19.7      | I2S Decoding (Option)                                     | 245        |

|        |  |     |
|--------|--|-----|
| 19.7.1 | Source Setting                                   | 246 |
| 19.7.2 | Bus Setting                                      | 247 |
| 19.7.3 | Display-related Setting                          | 248 |
| 19.7.4 | Event Table                                      | 248 |
| 19.8   | FlexRay Decoding (Option)                        | 249 |
| 19.8.1 | Signal Configuration                             | 250 |
| 19.8.2 | Display-related Setting                          | 251 |
| 19.8.3 | Event Table                                      | 251 |
| 19.9   | 1553B Decoding (Option)                          | 253 |
| 19.9.1 | To Set the Data Channel Source and the Threshold | 253 |
| 19.9.2 | Event Table                                      | 254 |
| 20     | Multi-pane Windowing                             | 256 |
| 21     | Waveform Recording and Playing                   | 258 |
| 21.1   | Common Settings                                  | 258 |
| 21.2   | Record Options                                   | 259 |
| 21.3   | Play Options                                     | 260 |
| 22     | Search and Navigation Function                   | 263 |
| 22.1   | Search Function                                  | 263 |
| 22.2   | Navigation Function                              | 266 |
| 23     | Display Control                                  | 269 |
| 23.1   | Display Type                                     | 269 |
| 23.2   | Persistence Time                                 | 269 |
| 23.3   | Waveform Intensity                               | 270 |
| 23.4   | To Set the Screen Grid                           | 270 |
| 23.5   | Display Settings                                 | 270 |
| 23.6   | Show Scale                                       | 271 |
| 23.7   | Color Grade                                      | 271 |
| 23.8   | Waveform Freeze                                  | 271 |
| 24     | To Store and Load                                | 272 |
| 24.1   | To Enter the Storage Menu                        | 272 |
| 24.2   | To Save a File                                   | 272 |
| 24.2.1 | To Save Image                                    | 272 |
| 24.2.2 | To Save Wave                                     | 274 |
| 24.2.3 | Save Setup                                       | 276 |
| 24.2.4 | Binary Data Format (.bin)                        | 278 |
| 24.3   | To Load a File                                   | 281 |
| 24.4   | Firmware Upgrade                                 | 282 |

---

|           |  |            |
|-----------|--|------------|
| 24.5      | Disk Management                        | 283        |
| <b>25</b> | <b>System Utility Function Setting</b> | <b>285</b> |
| 25.1      | I/O Setting                            | 285        |
| 25.2      | Basic Settings                         | 287        |
| 25.3      | About this Oscilloscope                | 290        |
| 25.4      | Other Settings                         | 290        |
| 25.5      | Auto Config                            | 291        |
| 25.6      | SelfCal                                | 291        |
| 25.7      | Option List                            | 292        |
| 25.8      | Quick Operation                        | 292        |
| 25.9      | Self-check                             | 294        |
| <b>26</b> | <b>Remote Control</b>                  | <b>297</b> |
| 26.1      | Remote Control via USB                 | 298        |
| 26.2      | Remote Control via LAN                 | 298        |
| 26.3      | Remote Control via GPIB                | 299        |
| <b>27</b> | <b>Troubleshooting</b>                 | <b>301</b> |
| <b>28</b> | <b>Appendix</b>                        | <b>303</b> |
| 28.1      | Appendix A: Options and Accessories    | 303        |
| 28.2      | Appendix B: Warranty                   | 304        |
| 28.3      | Appendix C: Factory Settings           | 305        |

## List of Figures

|  |    |
|--|----|
| Figure 4.1 DHO5108 Front Panel .....                                   | 13 |
| Figure 4.2 MHO5104 Front Panel .....                                   | 14 |
| Figure 4.3 Rear Panel .....  | 14 |
| Figure 4.4 Front View .....  | 15 |
| Figure 4.5 Side View .....   | 15 |
| Figure 4.6 Adjust the Supporting Legs .....                            | 16 |
| Figure 4.7 Connect to AC Power .....                                   | 16 |
| Figure 4.8 Replace the Fuse .....                                      | 18 |
| Figure 4.9 Connect the Passive Probe .....                             | 19 |
| Figure 4.10 Connect the Probe Head to the PA of the Active Probe ..... | 19 |
| Figure 4.11 Connect the Active Probe .....                             | 20 |
| Figure 4.12 Connect the Logic Probe .....                              | 21 |
| Figure 4.13 Use the Compensation Signal .....                          | 22 |
| Figure 4.14 Square Waveform Signal .....                               | 22 |
| Figure 4.15 Probe Compensation .....                                   | 23 |
| Figure 4.16 MHO5104 Front Panel .....                                  | 24 |
| Figure 4.17 DHO5108 Front Panel .....                                  | 24 |
| Figure 4.18 Rear Panel .....   | 31 |
| Figure 4.19 DHO5108 User Interface .....                               | 33 |
| Figure 4.20 MHO5104 User Interface .....                               | 33 |
| Figure 4.21 Tap Gesture .....  | 36 |
| Figure 4.22 Pinch&Stretch Gesture .....                                | 37 |
| Figure 4.23 Drag Gesture .....   | 38 |
| Figure 4.24 Rectangle Drawing Gesture (a) .....                        | 38 |
| Figure 4.25 Rectangle Drawing Gesture (b) .....                        | 39 |
| Figure 4.26 English Input Interface .....                              | 40 |
| Figure 4.27 Chinese Input Interface .....                              | 42 |

|  |    |
|--|----|
| Figure 4.28 Numeric Keypad .....   | 43 |
| Figure 4.29 To Use the Security Lock .....                               | 44 |
| Figure 5.1 Vertical Menu .....   | 46 |
| Figure 5.2 Input Impedance Switchover .....                              | 52 |
| Figure 5.3 Waveform Invert .....   | 53 |
| Figure 5.4 Probe Setting Menu .....                                      | 53 |
| Figure 5.5 Active Probe Setting Menu .....                               | 54 |
| Figure 5.6 Zero Offset .....   | 58 |
| Figure 6.1 Horizontal System Menu .....                                  | 59 |
| Figure 6.2 Zoom Mode .....   | 62 |
| Figure 7.1 Horizontal Menu .....   | 63 |
| Figure 7.2 Memory Depth .....  | 66 |
| Figure 7.3 XY Menu .....   | 69 |
| Figure 7.4 Measurement Schematic Diagram of Phase Deviation .....        | 70 |
| Figure 8.1 Trigger System Menu .....                                     | 72 |
| Figure 8.2 Schematic Diagram of the Acquisition Memory .....             | 75 |
| Figure 8.3 Trigger Holdoff .....   | 77 |
| Figure 8.4 Positive/Negative Pulse Width .....                           | 79 |
| Figure 8.5 Pulse Trigger Setting Menu .....                              | 79 |
| Figure 8.6 Positive Slope Time/Negative Slope Time .....                 | 81 |
| Figure 8.7 Slope Trigger Setting Menu .....                              | 82 |
| Figure 8.8 Video Trigger Setting Menu .....                              | 84 |
| Figure 8.9 Pattern Trigger .....   | 86 |
| Figure 8.10 Pattern Trigger Setting Menu of MHO Series 4-CH Model .....  | 87 |
| Figure 8.11 Pattern Trigger Setting Menu of DHO Series 8-CH Model .....  | 87 |
| Figure 8.12 Duration Trigger .....                                       | 89 |
| Figure 8.13 Duration Trigger Setting Menu of MHO Series 4-CH Model ..... | 89 |
| Figure 8.14 Duration Trigger Setting Menu of DHO Series 8-CH Model ..... | 90 |
| Figure 8.15 Timeout Trigger .....  | 92 |

---

|   |     |
|---|-----|
| Figure 8.16 Timeout Trigger Menu .....                | 92  |
| Figure 8.17 Runt Trigger .....                        | 93  |
| Figure 8.18 Runt Trigger Setting Menu .....           | 94  |
| Figure 8.19 Window Trigger Setting Menu .....         | 96  |
| Figure 8.20 Delay Trigger .....                       | 98  |
| Figure 8.21 Delay Trigger Setting Menu .....          | 98  |
| Figure 8.22 Setup/Hold Trigger .....                  | 100 |
| Figure 8.23 Setup/Hold Trigger Setting Menu .....     | 101 |
| Figure 8.24 Nth Edge Trigger .....                    | 103 |
| Figure 8.25 Nth Edge Trigger Setting Menu .....       | 103 |
| Figure 8.26 Schematic Diagram of RS232 Protocol ..... | 104 |
| Figure 8.27 RS232 Trigger Setting Menu .....          | 105 |
| Figure 8.28 Sequence Diagram of I2C Protocol .....    | 107 |
| Figure 8.29 I2C Trigger Setting Menu .....            | 107 |
| Figure 8.30 Binary Format Setting .....               | 109 |
| Figure 8.31 Hexadecimal Format Setting .....          | 109 |
| Figure 8.32 Sequential Chart of SPI Bus .....         | 110 |
| Figure 8.33 SPI Trigger Setting Menu .....            | 111 |
| Figure 8.34 Data Frame Format of the CAN Bus .....    | 113 |
| Figure 8.35 CAN Trigger Setting Menu .....            | 113 |
| Figure 8.36 Sample Position .....                     | 114 |
| Figure 8.37 Frame Format of FlexRay Bus .....         | 116 |
| Figure 8.38 FlexRay Trigger Setting Menu .....        | 116 |
| Figure 8.39 Data Frame Format of the LIN Bus .....    | 118 |
| Figure 8.40 LIN Trigger Setting Menu .....            | 118 |
| Figure 8.41 Sample Position .....                     | 119 |
| Figure 8.42 Sequential Chart of I2S Bus .....         | 121 |
| Figure 8.43 I2S Trigger Setting Menu .....            | 121 |

|  |     |
|--|-----|
| Figure 8.44 Formats of the Command Word, Data Word, and Status Word of the 1553B Bus ..... | 124 |
| Figure 8.45 MIL-STD-1553 Trigger Setting Menu .....  | 125 |
| Figure 9.1 Math Operation Menu .....   | 131 |
| Figure 9.2 Math Operation Result Display Window .....                                      | 131 |
| Figure 9.3 Arithmetic Operation Result Display Window .....                                | 132 |
| Figure 9.4 Function Operation Menu .....   | 133 |
| Figure 9.5 Function Operation Result Display Window .....                                  | 134 |
| Figure 9.6 FFT Operation Menu .....  | 135 |
| Figure 9.7 FFT Operation Result Display Window .....                                       | 136 |
| Figure 9.8 Peak Search .....   | 138 |
| Figure 9.9 Logic Operation Menu .....  | 140 |
| Figure 9.10 Logic Operation Result Display Window .....                                    | 141 |
| Figure 9.11 Digital Filter Menu .....  | 142 |
| Figure 9.12 Digital Filter Operation Result Display Window .....                           | 143 |
| Figure 10.1 Time Parameters .....  | 147 |
| Figure 10.2 Delay and Phase Parameters .....   | 150 |
| Figure 10.3 Voltage Parameters .....   | 151 |
| Figure 10.4 Measurement Settings Menu .....  | 154 |
| Figure 10.5 Cursors .....  | 160 |
| Figure 10.6 Manual Mode Setting Menu .....   | 162 |
| Figure 10.7 Manual Cursor Measurement Example .....  | 164 |
| Figure 10.8 Track Mode Setting Menu .....  | 165 |
| Figure 10.9 Track Measurement (before Horizontal Expansion) .....                          | 166 |
| Figure 10.10 Track Measurement (after Horizontal Expansion) .....                          | 167 |
| Figure 10.11 XY Mode Setting Menu .....  | 167 |
| Figure 11.1 DVM Setting Menu .....   | 170 |
| Figure 11.2 Frequency Counter Setting Menu .....   | 172 |
| Figure 12.1 Basic Settings Tab of Logic Analyzer Interface .....                           | 174 |

|  |     |
|--|-----|
| Figure 12.2 Other Settings Tab of Logic Analyzer Interface ..... | 177 |
| Figure 13.1 Histogram Setting Menu .....                         | 179 |
| Figure 13.2 Histogram Analysis Interface .....                   | 180 |
| Figure 14.1 AFG Menu .....                                       | 184 |
| Figure 14.2 Exp.Rise .....                                       | 188 |
| Figure 14.3 Exp.Fall .....                                       | 189 |
| Figure 14.4 ECG1 .....   | 189 |
| Figure 14.5 Gauss .....  | 190 |
| Figure 14.6 Lorentz .....  | 190 |
| Figure 14.7 Haversine .....                                      | 191 |
| Figure 14.8 Sinc .....   | 191 |
| Figure 14.9 Modulation Setting Interface .....                   | 192 |
| Figure 14.10 AM .....  | 193 |
| Figure 14.11 FM .....  | 195 |
| Figure 14.12 PM .....  | 196 |
| Figure 15.1 Bode Plots Setting Menu .....                        | 198 |
| Figure 15.2 Bode Plots Setting Menu-Simplified Mode .....        | 198 |
| Figure 15.3 Bode Plot Waveform Display .....                     | 201 |
| Figure 15.4 Bode Plot Chart Display .....                        | 202 |
| Figure 16.1 Power Analysis Interface .....                       | 204 |
| Figure 16.2 Power Quality Analysis Result Display .....          | 206 |
| Figure 16.3 Connection Diagram of Power Quality Analysis .....   | 206 |
| Figure 16.4 Ripple Analysis Result Display .....                 | 207 |
| Figure 16.5 Connection Diagram of Ripple Analysis .....          | 208 |
| Figure 17.1 Reference Waveform Menu .....                        | 209 |
| Figure 18.1 Pass/Fail Test Menu .....                            | 213 |
| Figure 18.2 Pass/Fail Test Interface .....                       | 214 |
| Figure 18.3 Pass/Fail Test Interface .....                       | 217 |
| Figure 19.1 Schematic Diagram of Parallel Decoding .....         | 219 |

|   |     |
|---|-----|
| Figure 19.2 Parallel Decoding Menu .....                | 220 |
| Figure 19.3 Parallel Decoding Event Table .....         | 224 |
| Figure 19.4 Schematic Diagram of RS232 Serial Bus ..... | 225 |
| Figure 19.5 RS232 Decoding Menu .....                   | 226 |
| Figure 19.6 RS232 Decoding Event Table .....            | 229 |
| Figure 19.7 I2C Serial Bus .....                        | 230 |
| Figure 19.8 I2C Decoding Menu .....                     | 230 |
| Figure 19.9 I2C Decoding Event Table .....              | 232 |
| Figure 19.10 SPI Serial Bus .....                       | 233 |
| Figure 19.11 SPI Decoding Menu .....                    | 234 |
| Figure 19.12 SPI Decoding Event Table .....             | 237 |
| Figure 19.13 CAN Decoding Menu .....                    | 238 |
| Figure 19.14 Sample Position .....                      | 240 |
| Figure 19.15 CAN Decoding Event Table .....             | 241 |
| Figure 19.16 LIN Decoding Menu .....                    | 243 |
| Figure 19.17 LIN Decoding Event Table .....             | 244 |
| Figure 19.18 I2S Decoding Menu .....                    | 246 |
| Figure 19.19 I2S Decoding Event Table .....             | 248 |
| Figure 19.20 FlexRay Decoding Menu .....                | 249 |
| Figure 19.21 Sample Position .....                      | 250 |
| Figure 19.22 FlexRay Decoding Event Table .....         | 251 |
| Figure 19.23 1553B Decoding Menu .....                  | 253 |
| Figure 19.24 1553B Decoding Event Table .....           | 254 |
| Figure 20.1 Add Window Menu .....                       | 256 |
| Figure 21.1 Waveform Recording Interface .....          | 258 |
| Figure 21.2 Play Operation Interface .....              | 261 |
| Figure 22.1 Search Menu .....                           | 263 |
| Figure 22.2 Marker Table .....                          | 265 |
| Figure 22.3 Navigation Menu .....                       | 266 |

---

|   |     |
|---|-----|
| Figure 22.4 Navigation Menu-Simple Mode .....       | 266 |
| Figure 22.5 Search Event Navigation Interface ..... | 267 |
| Figure 23.1 Display Setting Menu .....              | 269 |
| Figure 24.1 Image Saving Setting Menu .....         | 273 |
| Figure 24.2 Waveform Saving Setting Menu .....      | 275 |
| Figure 24.3 Setup Saving Setting Menu .....         | 277 |
| Figure 24.4 Load Setting Menu .....                 | 281 |
| Figure 24.5 Upgrade Menu .....                      | 282 |
| Figure 24.6 Disk Management Interface .....         | 283 |
| Figure 25.1 Self-calibration Menu .....             | 292 |
| Figure 25.2 Key Test Interface .....                | 294 |
| Figure 25.3 Touch Screen Test Interface .....       | 295 |
| Figure 26.1 Search for the Available Device .....   | 300 |
| Figure 26.2 Confirm the Available Device .....      | 300 |

# List of Tables

|   |     |
|---|-----|
| Table 5.1 Probe Ratio .....                           | 55  |
| Table 5.2 Range of the External Attenuation .....     | 56  |
| Table 8.1 Video Standard .....                        | 85  |
| Table 9.1 Window Function .....                       | 137 |
| Table 9.2 Logic Operation .....                       | 140 |
| Table 19.1 Bus Setting of DHO Series 8-CH Model ..... | 221 |
| Table 19.2 Bus Setting of MHO Series 4-CH Model ..... | 222 |
| Table 24.1 BIN File Format .....                      | 278 |
| Table 24.2 File Header .....                          | 278 |
| Table 24.3 Waveform Header .....                      | 279 |
| Table 24.4 Waveform Data Header .....                 | 280 |
| Table 28.2 Factory Settings .....                     | 305 |

# 1 Safety Requirement

---

## 1.1 General Safety Summary

---

Please review the following safety precautions carefully before putting the instrument into operation so as to avoid any personal injury or damage to the instrument and any product connected to it. To prevent potential hazards, please follow the instructions specified in this manual to use the instrument properly.

- **Use Proper Power Cord.**

Only the exclusive power cord designed for the instrument and authorized for use within the local country could be used.

- **Ground the Instrument.**

The instrument is grounded through the Protective Earth lead of the power cord. To avoid electric shock, it is essential to connect the earth terminal of the power cord to the Protective Earth terminal before connecting any inputs or outputs.

- **Connect the Probe Correctly.**

If a probe is used, the probe ground lead must be connected to earth ground. Do not connect the ground lead to high voltage. Improper way of connection could result in dangerous voltages being present on the connectors, controls or other surfaces of the oscilloscope and probes, which will cause potential hazards for operators.

- **Observe All Terminal Ratings.**

To avoid fire or shock hazard, observe all ratings and markers on the instrument and check your manual for more information about ratings before connecting the instrument.

- **Use Proper Overvoltage Protection.**

Ensure that no overvoltage (such as that caused by a bolt of lightning) can reach the product. Otherwise, the operator might be exposed to the danger of an electric shock.

- **Do Not Operate Without Covers.**

Do not operate the instrument with covers or panels removed.

- **Do Not Insert Objects Into the Air Outlet.**

Do not insert anything into the holes of the fan to avoid damaging the instrument.

- **Use Proper Fuse.**

Please use the specified fuses.

- **Avoid Circuit or Wire Exposure.**

Do not touch exposed junctions and components when the unit is powered on.
- **Do Not Operate With Suspected Failures.**

If you suspect damage occurs to the instrument, have it inspected by RIGOL authorized personnel before further operations. Any maintenance, adjustment or replacement especially to circuits or accessories must be performed by RIGOL authorized personnel.
- **Provide Adequate Ventilation.**

Inadequate ventilation may cause an increase of temperature in the instrument, which would cause damage to the instrument. So please keep the instrument well ventilated and inspect the air outlet and the fan regularly.
- **Do Not Operate in Wet Conditions.**

To avoid short circuit inside the instrument or electric shock, never operate the instrument in a humid environment.
- **Do Not Operate in an Explosive Atmosphere.**

To avoid personal injuries or damage to the instrument, never operate the instrument in an explosive atmosphere.
- **Keep Instrument Surfaces Clean and Dry.**

To avoid dust or moisture from affecting the performance of the instrument, keep the surfaces of the instrument clean and dry.
- **Prevent Electrostatic Impact.**

Operate the instrument in an electrostatic discharge protective environment to avoid damage induced by static discharges. Always ground both the internal and external conductors of cables to release static before making connections.
- **Use the Battery Properly.**

Do not expose the battery (if available) to high temperature or fire. Keep it out of the reach of children. Improper change of a battery (lithium battery) may cause an explosion. Use the RIGOL specified battery only.
- **Handle with Caution.**

Please handle with care during transportation to avoid damage to keys, knobs, interfaces, and other parts on the panels.

**WARNING**

**Equipment meeting Class A requirements may not offer adequate protection to broadcast services within residential environment.**

## 1.2 Safety Notices and Symbols

### Safety Notices in this Manual:



#### WARNING

Indicates a potentially hazardous situation or practice which, if not avoided, will result in serious injury or death.



#### CAUTION

Indicates a potentially hazardous situation or practice which, if not avoided, could result in damage to the product or loss of important data.

### Safety Notices on the Product:

- **DANGER**

It calls attention to an operation, if not correctly performed, could result in injury or hazard immediately.

- **WARNING**

It calls attention to an operation, if not correctly performed, could result in potential injury or hazard.

- **CAUTION**

It calls attention to an operation, if not correctly performed, could result in damage to the product or other devices connected to the product.

### Safety Symbols on the Product:



Hazardous  
Voltage



Safety Warning



Protective Earth  
Terminal



Chassis Ground

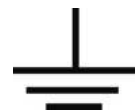

Test Ground

## 1.3 Measurement Category

### Measurement Category

This instrument can make measurements in Measurement Category I.



#### WARNING

This instrument can only be used for measurements within its specified measurement categories.

## Measurement Category Definitions

- **Measurement category I** is for measurements performed on circuits not directly connected to MAINS. Examples are measurements on circuits not derived from MAINS, and specially protected (internal) MAINS derived circuits. In the latter case, transient stresses are variable. Thus, you must know the transient withstand capability of the equipment.
- **Measurement category II** is for measurements performed on circuits directly connected to low voltage installation. Examples are measurements on household appliances, portable tools and similar equipment.
- **Measurement category III** is for measurements performed in the building installation. Examples are measurements on distribution boards, circuit-breakers, wiring (including cables, bus-bars, junction boxes, switches and socket-outlets) in the fixed installation, and equipment for industrial use and some other equipment. For example, stationary motors with permanent connection to a fixed installation.
- **Measurement category IV** is for measurements performed at the source of a low-voltage installation. Examples are electricity meters and measurements on primary overcurrent protection devices and ripple control units.

## 1.4 Ventilation Requirement

This instrument uses a fan to force cooling. Please make sure that the air inlet and outlet areas are free from obstructions and have free air. When using the instrument in a bench-top or rack setting, provide at least 10 cm clearance beside, above and behind the instrument for adequate ventilation.



### CAUTION

Inadequate ventilation may cause an increase of temperature in the instrument, which would cause damage to the instrument. So please keep the instrument well ventilated and inspect the air outlet and the fan regularly.

## 1.5 Working Environment

### Temperature

Operating: -10°C to +50°C

Non-operating: -30°C to +60°C

### Humidity

- **Operating:**
  - Below +30°C: ≤90%RH (without condensation)
  - +30°C to +40°C: ≤75% RH (without condensation)

+40°C to +50°C: ≤45%RH (without condensation)

- **Non-operating:**

Below +60°C: ≤90% RH (without condensation)



### **WARNING**

**To avoid short circuit inside the instrument or electric shock, never operate the instrument in a humid environment.**

### **Altitude**

- **Operating:** below 3 km
- **Non-operating:** below 15 km

### **Protection level against electric shock**

ESD ±8kV

### **Installation (Overvoltage) Category**

This product is powered by mains conforming to installation (overvoltage) category II.



### **WARNING**

**Ensure that no overvoltage (such as that caused by a bolt of lightning) can reach the product. Otherwise, the operator might be exposed to the danger of an electric shock.**

### **Installation (Overvoltage) Category Definitions**

Installation (overvoltage) category I refers to signal level which is applicable to equipment measurement terminals connected to the source circuit. Among these terminals, precautions are done to limit the transient voltage to a low level.

Installation (overvoltage) category II refers to the local power distribution level which is applicable to equipment connected to the AC line (AC power).

### **Pollution Degree**

Pollution Degree 2

### **Pollution Degree Definition**

- **Pollution Degree 1:** No pollution or only dry, nonconductive pollution occurs. The pollution has no effect. For example, a clean room or air-conditioned office environment.
- **Pollution Degree 2:** Normally only nonconductive pollution occurs. Temporary conductivity caused by condensation is to be expected. For example, indoor environment.

- **Pollution Degree 3:** Conductive pollution or dry nonconductive pollution that becomes conductive due to condensation occurs. For example, sheltered outdoor environment.
- **Pollution Degree 4:** The pollution generates persistent conductivity caused by conductive dust, rain, or snow. For example, outdoor areas.

### Safety Class

Class 1 – Grounded Product

## 1.6 Care and Cleaning

### Care

Do not store or leave the instrument where it may be exposed to direct sunlight for long periods of time.

### Cleaning

Clean the instrument regularly according to its operating conditions.

1. Disconnect the instrument from all power sources.
2. Clean the external surfaces of the instrument with a soft cloth dampened with mild detergent or water. Avoid having any water or other objects into the chassis via the heat dissipation hole. When cleaning the LCD, take care to avoid scarifying it.

### CAUTION

To avoid damage to the instrument, do not expose it to caustic liquids.



### WARNING

To avoid short-circuit resulting from moisture or personal injuries, ensure that the instrument is completely dry before connecting it to the power supply.



## 1.7 Environmental Considerations

The following symbol indicates that this product complies with the WEEE Directive 2012/19/EU.



The equipment may contain substances that could be harmful to the environment or human health. To avoid the release of such substances into the environment and avoid harm to human health, we recommend you to recycle this product

appropriately to ensure that most materials are reused or recycled properly. Please contact your local authorities for disposal or recycling information.

You can click on the following link <https://int.rigol.com/services/services/declaration> to download the latest version of the RoHS&WEEE certification file.

## 2 Product Features

### Product Features

- Based on RIGOL's brand new self-developed Centaurus technical platform
- 12-bit resolution for all the series<sup>[1]</sup>
- Max. 1 GHz bandwidth, 8 analog channels, and 1 external trigger channel
- Standard configuration of 16 digital channels (required to purchase the logic analyzer probe) for the MHO models
- Real-time sample rate: up to 4 GSa/s
- Max. memory depth 500 Mpts
- Vertical sensitivity up to 100  $\mu\text{V}/\text{div}$
- Maximum waveform capture rate of 1,000,000 wfms/s in fast recording mode
- Arbitrary Waveform/Function Generator (AFG)<sup>[2]</sup>, power analysis, histogram, and digital signal analysis<sup>[3]</sup>, Bode plot<sup>[4]</sup>, and protocol decodings
- Search and navigation function helps users quickly search for the signals with exceptions and locate them accurately.
- 256-level intensity grading display, with digital real-time fluorescence technology
- 10.1" 1280\*800 high-definition touch screen
- Brand new Flex knob brings friendly user experience
- Standard configuration of USB Device, USB Host, LAN, HDMI interfaces for all the series
- Battery pack-powered, convenient to charge anytime and anywhere, providing great feasibility for measurement
- Online upgrade
- Standard configuration of the photoelectric encoder operating knob for all the series to improve the service life of the instrument

The MHO/DHO5000 series is a 8-CH high-resolution digital oscilloscope designed for the vast mainstream digital oscilloscope market to meet the design, debugging, and test demands. It is developed based on RIGOL's brand new self-developed Centaurus technical platform. Its 1,000,000 wfms/s waveform capture rate (in fast recording mode), 500 Mpts memory depth, 12-bit resolution, excellent noise floor and vertical measurement accuracy can meet the test demands for higher accuracy. The MHO/DHO5000 series digital oscilloscope has multiple models, supporting AFG, digital signal analysis, Bode plot, and other functions. It is powered by battery pack, convenient to operate and control, applicable for various complex test scenarios.

#### Note:

[1]: Up to 16-bit in high resolution mode.

[2]: Only MHO5054 and MHO5104 models support configuring the AFG option.

[3]: Digital signal analysis is only available for the MHO series.

[4]: The Bode plot function is only available for MHO5054 and MHO5104 models.

### 3 Document Overview

This manual gives you a quick overview of the front and rear panel, user interface as well as basic operation methods of MHO/DHO5000 series.



**TIP**

For the latest version of this manual, download it from the official website of RIGOL (<http://www.rigol.com>).

**Publication Number**

UGA43100-1110

**Software Version**

00.01.00

Software upgrade might change or add product features. Please acquire the latest version of the manual from RIGOL website or contact RIGOL to upgrade the software.

**Format Conventions in this Manual**

**1. Key**

The front panel key is denoted by the menu key icon. For example,  indicates the "DEFAULT" key.

**2. Menu**

The menu item is denoted by the format of "Menu Name (Bold) + Character Shading" in the manual. For example, **Setup** indicates the "Setup" sub-menu under the "Utility" function menu. You can click or tap **Setup** to access the "Setup" menu.



**3. Operation Procedures**





The next step of the operation is denoted by ">" in the manual. For example, 

> **Storage** indicates first clicking or tapping  and then clicking or tapping **Storage**.

4. The front/rear panel connector is denoted by "Brackets + Connector Name (Bold)", for example, **[AUX OUT]**.

**5. Knob**

| Label  | Knob                     | Label  | Knob                 |
|--|--------------------------|--|----------------------|
| <b>Horizontal POSITION</b>  | Horizontal Position Knob |  <b>1</b> | Multifunction Knob 1 |

| Label  | Knob                   | Label  | Knob                 |
|--|------------------------|--|----------------------|
| Horizontal  <u>SCALE</u>  | Horizontal Scale Knob  |  <u>2</u>     | Multifunction Knob 2 |
| Vertical  <u>POSITION</u> | Vertical Position Knob |  <u>LEVEL</u> | Trigger Level Knob   |
| Vertical  <u>SCALE</u>    | Vertical Scale Knob    | -  | -                    |

### Content Conventions in this Manual

MHO/DHO5000 series digital oscilloscope includes the following models, which support different combinations of features.

| Model   | Max. Analog Bandwidth | Analog Channels | Function/<br>Arbitrary<br>Waveform<br>Generator<br>Channels | Digital Channels | Bode Plot                |
|---------|-----------------------|-----------------|---|------------------|--------------------------|
| DHO5054 | 500 MHz               | 4               | -   | -                | -                        |
| DHO5104 | 1 GHz                 | 4               | -   | -                | -                        |
| MHO5054 | 500 MHz               | 4               | 2 <sup>[1]</sup>  | 16               | Supported <sup>[1]</sup> |
| MHO5104 | 1 GHz                 | 4               | 2 <sup>[1]</sup>  | 16               | Supported <sup>[1]</sup> |
| MHO5056 | 500 MHz               | 6               | -   | 16               | -                        |
| MHO5106 | 1 GHz                 | 6               | -   | 16               | -                        |
| DHO5058 | 500 MHz               | 8               | -   | -                | -                        |
| DHO5108 | 1 GHz                 | 8               | -   | -                | -                        |

**Note:** [1] The MHO5000-AWG option is required to be installed for use.

- Analog channels supported by each model:
  - DHO5058/DHO5108: CH1 to CH8
  - DHO5054/DHO5104: CH1 to CH4
  - MHO5056/MHO5106: CH1 to CH6
  - MHO5054/MHO5104: CH1 to CH4
- Only MHO series models support digital channels: D0 to D15

Unless otherwise specified, this manual takes DHO5108 as an example to illustrate the operation methods of MHO/DHO5000 series. The digital analysis, function/arbitrary waveform generator and Bode plot are illustrated by the MHO5104 model.

## 4 Quick Start

### 4.1 General Inspection

#### 1. Inspect the packaging

If the packaging has been damaged, do not dispose the damaged packaging or cushioning materials until the shipment has been checked for completeness and has passed both electrical and mechanical tests.

The consigner or carrier shall be liable for the damage to the instrument resulting from shipment. RIGOL would not be responsible for free maintenance/rework or replacement of the instrument.

#### 2. Inspect the instrument

In case of any mechanical damage, missing parts, or failure in passing the electrical and mechanical tests, contact your RIGOL sales representative.

#### 3. Check the accessories

Please check the accessories according to the packing lists. If the accessories are damaged or incomplete, please contact your RIGOL sales representative.

#### Recommended Calibration Interval

RIGOL suggests that the instrument should be calibrated every 18 months.

### 4.2 Product Appearance



Figure 4.1 DHO5108 Front Panel



Figure 4.2 MHO5104 Front Panel



Figure 4.3 Rear Panel

## 4.3 Appearance and Dimensions

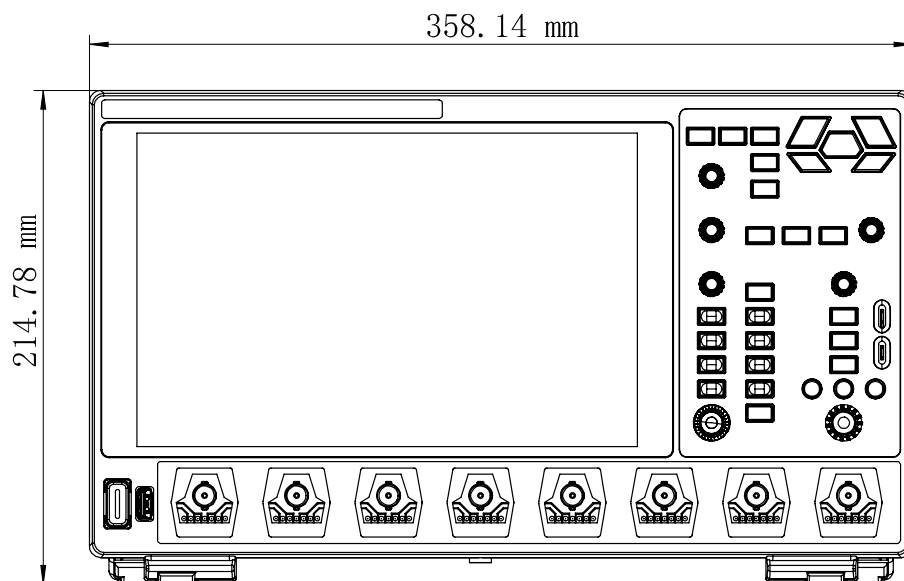

Figure 4.4 Front View

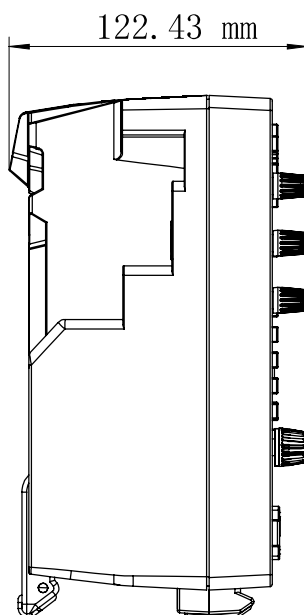

Figure 4.5 Side View

## 4.4 To Prepare for Use

### 4.4.1 To Adjust the Supporting Legs

Adjust the supporting legs properly to use them as stands to tilt the oscilloscope upwards for stable placement of the oscilloscope to better operate and observe. You

can also fold the supporting legs when the instrument is not in use for easier storage or shipment, as shown in the figure below.

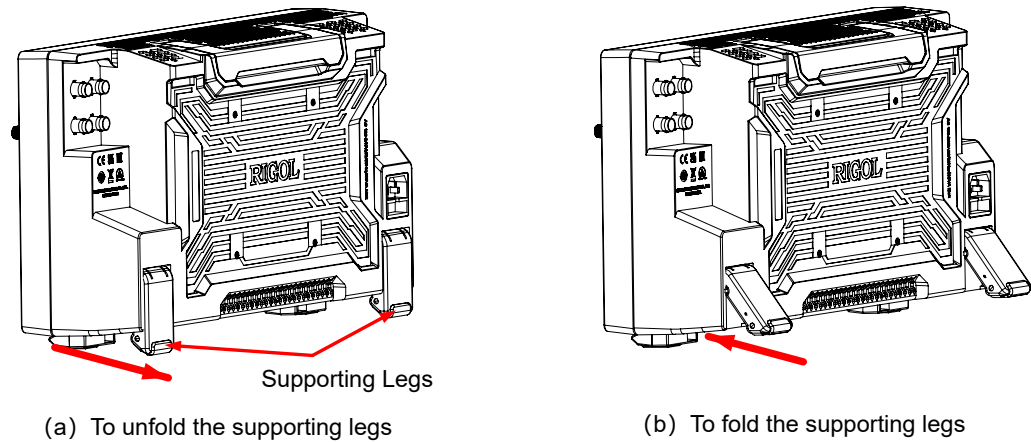

**Figure 4.6 Adjust the Supporting Legs**

#### 4.4.2 To Connect to AC Power

The AC power requirements of the oscilloscope are 100-240 V, 50/60 Hz, 400VA Max. Please use the power cord provided in the accessories to connect the oscilloscope to the AC power source, as shown in the figure below.

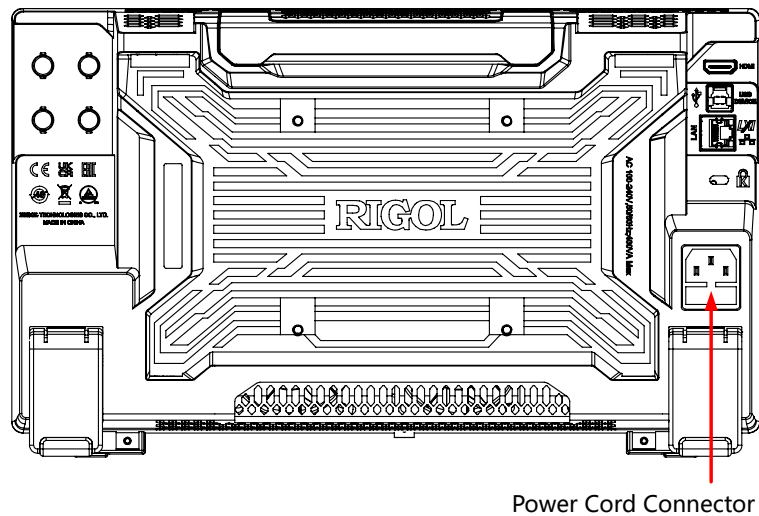

**Figure 4.7 Connect to AC Power**



#### **WARNING**





To avoid electric shock, ensure that the instrument is correctly grounded.

**TIP**

When the oscilloscope equipped with the battery pack is connected to the AC power, the oscilloscope is energized and the AC power can also charge the battery pack. For details about battery pack installation, refer to *BatHolder138 User Guide*.

### 4.4.3 Turn-on Checkout

After the instrument is connected to the power source, press the power key  at the lower-left corner of the front panel to power on the instrument. During the start-up process, the instrument performs a series of self-tests. After the self-test, the splash screen is displayed.

- **Restart:** Click or tap  > **Restart**. Then a prompt message "Are you sure to reboot?" is displayed. Click or tap **OK** to restart the instrument.
- **Shutdown:**
  - Click or tap  > **Shutdown**. Then a prompt message "Are you sure to shutdown?" is displayed. Click or tap **OK** to shut down the instrument.
  - Press the power key  and a prompt message "Are you sure to shutdown?" is displayed. Click or tap **OK** to shut down the instrument.
  - Press  twice to directly shut down the instrument.
  - Press  for three seconds to directly shut down the instrument.

**TIP**

You can also click or tap  > **Utility** > **Setup**, then select "Switch On" under the "Power Status" menu. After this setting, the instrument powers on once connected to power.

### 4.4.4 To Replace the Fuse

If you need to replace the fuse, please use the proper fuse (AC 250 V, T3.15 A; 5.2 mm×20 mm) and follow the steps shown below (see *Figure 4.8*).

1. Power off the instrument and remove the power cord.
2. Insert a small straight screwdriver into the slot at the power socket and pry out the fuse holder gently.
3. Remove the fuse.
4. Insert the proper fuse into the fuse holder.

5. Re-insert the fuse holder into the power socket.

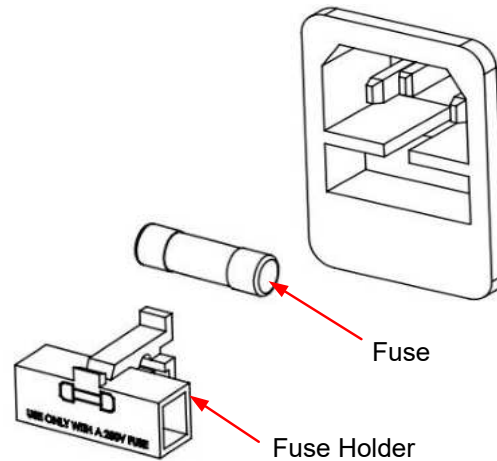



Figure 4.8 Replace the Fuse



#### WARNING

To avoid electric shock, please make sure that the instrument is powered off and disconnected from the power before replacing the fuse. Also, please make sure the fuse is consistent with the required fuse rating.

### 4.4.5 To Set the System Language

This oscilloscope supports multiple languages. You can click or tap  > **Utility** > **Setup** > **Language** to select the system language.

### 4.4.6 To Connect the Probe

RIGOL provides the passive probe, active probe, and logic probe for MHO/DHO5000 series. For specific probe models, please refer to *MHO/DHO5000 Data Sheet*. For detailed technical information of the probes, please refer to the corresponding Probe User Guide.

#### Connect the Passive Probe

1. Connect the BNC terminal of the probe to an analog channel input terminal of the oscilloscope on the front panel as shown in the figure below.
2. Connect the ground alligator clip or spring of the probe to the circuit ground terminal, and then connect the probe tip to the circuit point to be tested.

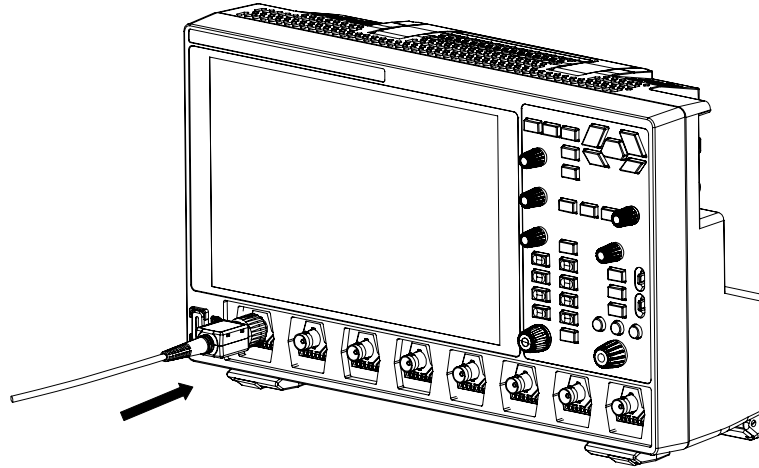

**Figure 4.9 Connect the Passive Probe**

After you connect the passive probe, check the probe function and probe compensation adjustment before making measurements. For details, please refer to *Function Inspection* and *Probe Compensation*.

#### **Connect the Active Probe**

Take PVA7250 (active differential probe) as an example.

1. Connect the probe head to the preamp of the active probe, as shown in the figure below.

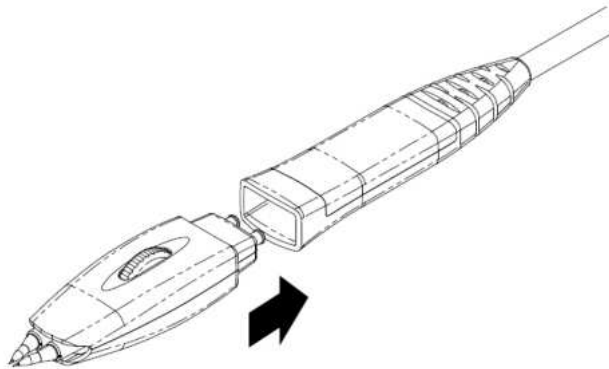

**Figure 4.10 Connect the Probe Head to the PA of the Active Probe**

2. Connect the other end of the preamp to an analog channel input terminal of the oscilloscope on the front panel, as shown in the figure below. Note that you need to push the probe to the due position to lock it firmly.

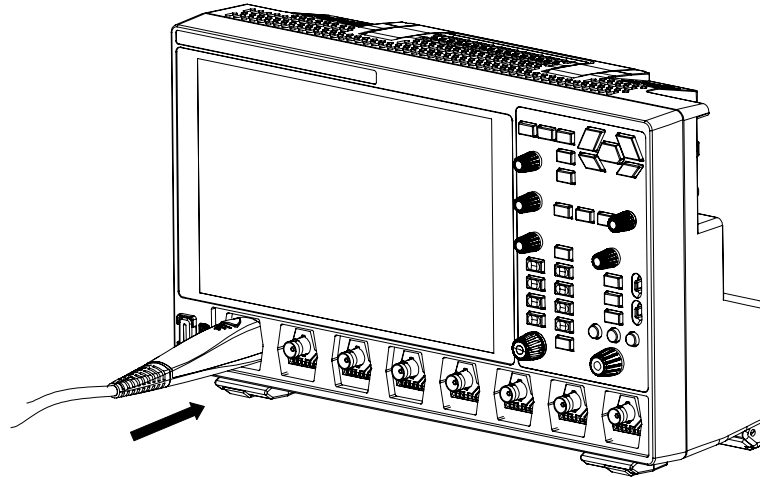

**Figure 4.11 Connect the Active Probe**

3. Use the probe's auxiliary device to connect the probe head to the circuit under test. For detailed information of the probes, please refer to *User Guide for PVA7000 Series Active Probe*.

After connecting the active probe, you can perform probe calibration and offset voltage adjustment if necessary. For details, refer to descriptions about the active probe in this User Guide.

### **Connect the Logic Probe**

1. Connect the output terminal of the logic probe to the digital channel input terminal on the front panel of the oscilloscope in the correct direction, as shown in the figure below.
2. Connect the other terminal of the logic probe to the signal terminal under test. MHO/DHO5000 provides the optional PLA3204 active logic probe. For details, refer to *User Guide for PLA3204 Logic Probe*.

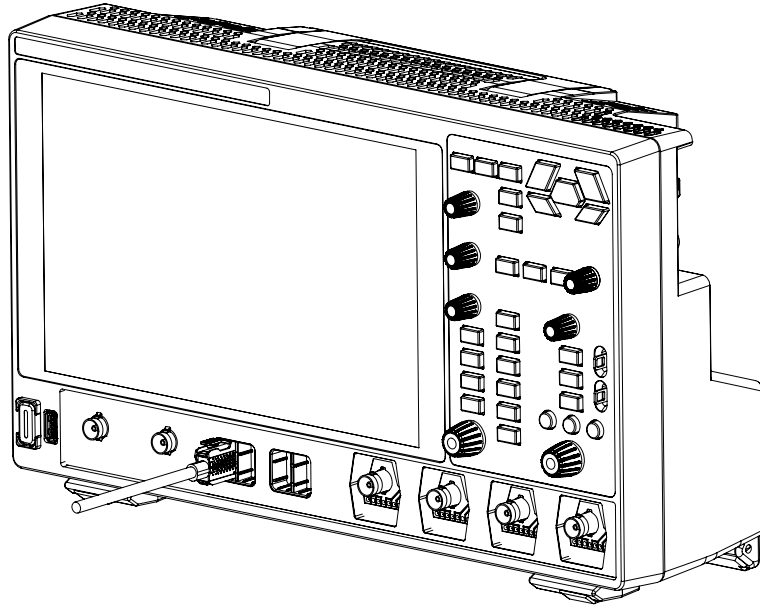

**Figure 4.12 Connect the Logic Probe**



**TIP**

- For ground connection of high-speed signals, the ground lead shall be connected to the ground test point near the measured signal, and the ground lead shall be kept as short as possible.
- If there are a large number of input signal channels, please connect each signal to a ground signal as far as possible. If there is only one ground test point, connect all ground leads on the probe to the ground test point.
- Set a proper threshold value for the logic probe according to the actual level range of the signal under test. Set the threshold value to the middle of the level range.

## 4.4.7 Function Inspection

1. Press the front-panel  and a prompt message "Restore default settings?" is displayed. Click or tap **OK** to restore the instrument to its factory default settings.
2. Connect the ground alligator clip of the probe to the "Ground Terminal" as shown in [Figure 4.13](#).
3. Use the probe to connect the input terminal of CH1 and the "Compensation Signal Output Terminal" of the probe, as shown in [Figure 4.13](#).

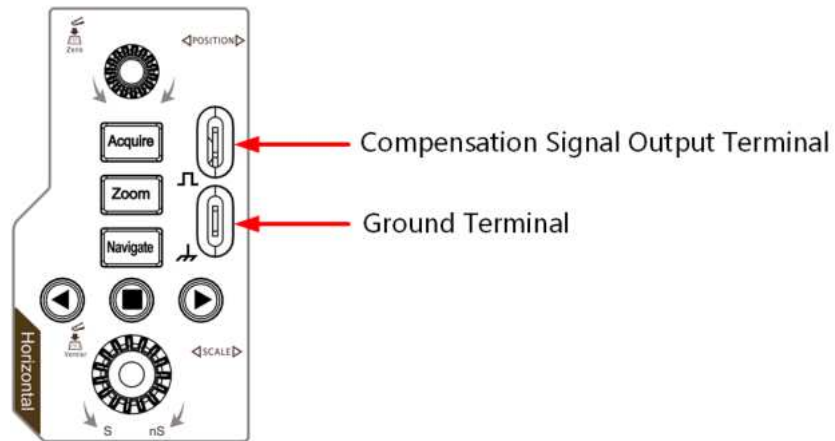

**Figure 4.13 Use the Compensation Signal**

- Set the probe ratio based on the attenuation of the probe, and then click or tap  > **Auto**.
- Observe the waveform on the display. In normal condition, you should see a square waveform as shown in the figure below.

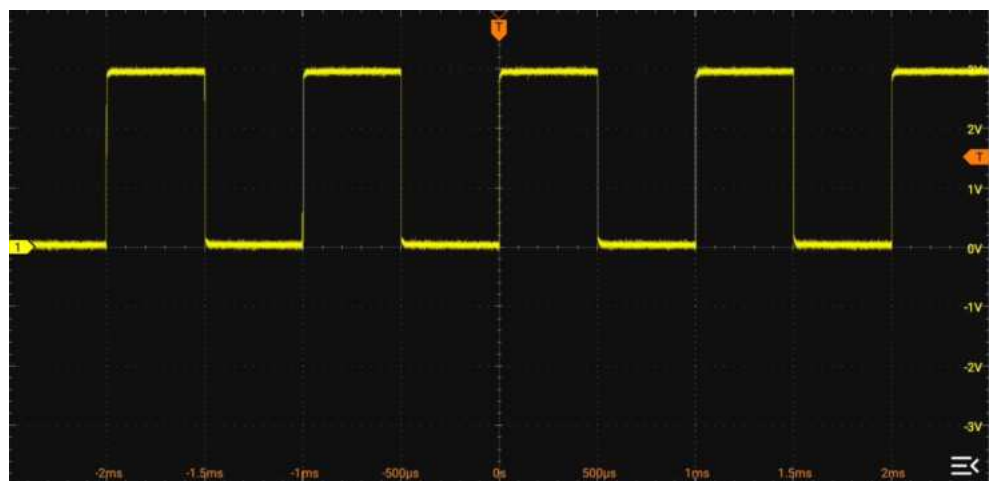

**Figure 4.14 Square Waveform Signal**

- Use the same method to test other channels. If the square waveforms actually shown do not match that in the figure above, please perform *Probe Compensation* introduced in the next section. If no waveform is displayed on the screen, perform the above steps again.



**WARNING**

To avoid electric shock when using the probe, please make sure that the insulated wire of the probe is in good condition. Do not touch the metallic part of the probe when the probe is connected to high voltage source.

## 4.4.8 Probe Compensation

When used for the first time, the oscilloscope probe must be compensated to match the input characteristics of the oscilloscope channel to which it is connected. The non-compensated or poorly compensated probe may cause measurement errors. The compensation procedure is as follows:

1. Perform step 1, 2, 3, and 4 in *Function Inspection*.
2. Check the displayed waveforms and compare them with waveforms shown in the figure below.

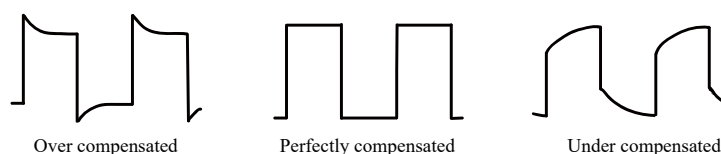

**Figure 4.15 Probe Compensation**

3. Use the probe compensation adjustment tool provided in the accessories to adjust the low-frequency compensation adjustment hole on the probe until the displayed waveform is consistent with the "Perfectly compensated" waveform shown in the figure above.

## 4.5 Product Overview

RIGOL MHO/DHO5000 series is a high-resolution digital oscilloscope designed for the vast mainstream digital oscilloscope market to meet the design, debugging, and test demands. It is developed based on RIGOL's brand new self-developed Centaurus technical platform. Its 4 GSa/s sample rate, 1 GHz real-time bandwidth, 1,000,000 wfms/s waveform capture rate (in fast recording mode), 500 Mpts memory depth, 12-bit resolution, excellent noise floor and vertical measurement accuracy can meet the test demands for higher accuracy. MHO/DHO5000 series digital oscilloscope has multiple models, supporting AFG, digital signal analysis, Bode plot, and other functions. It is powered by battery pack, convenient to operate and control, applicable for various complex test scenarios.

### 4.5.1 Front Panel Overview

This chapter takes the MHO5104 model with digital channels and arbitrary waveform generator (AFG) features, and the eight-channel DHO5108 model as examples to introduce the front panel.

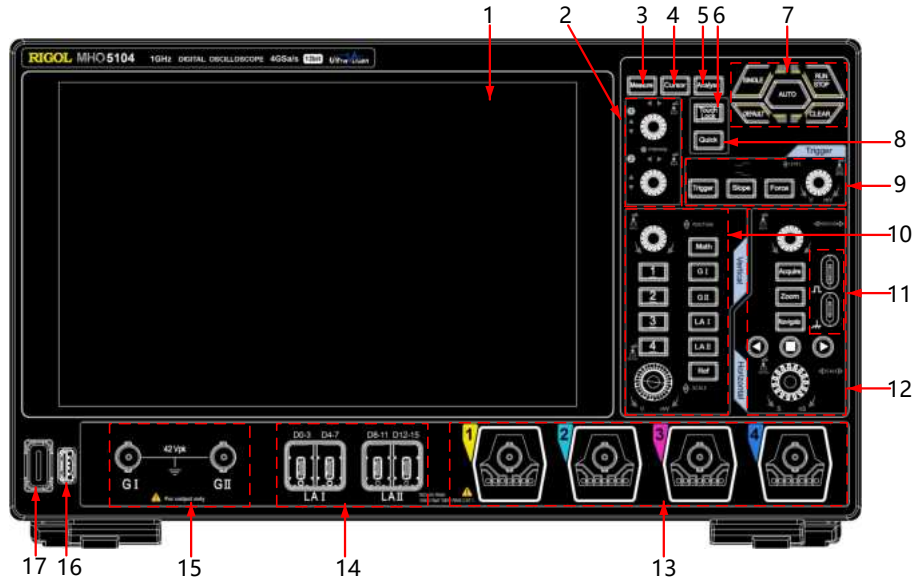

Figure 4.16 MHO5104 Front Panel

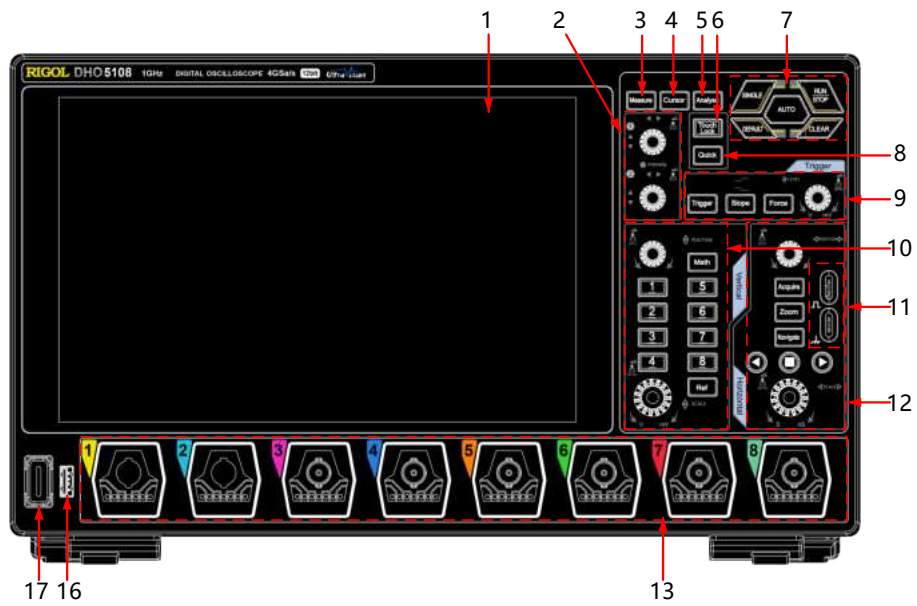

Figure 4.17 DHO5108 Front Panel

- |   |                               |    |   |
|---|-------------------------------|----|---|
| 1 | 10.1" Capacitive Touch Screen | 10 | Vertical Control Area                                     |
| 2 | Multifunction Knobs           | 11 | Probe Compensation Signal Output Terminal/Ground Terminal |
| 3 | Measure Key                   | 12 | Horizontal Control Area                                   |
| 4 | Cursor Key                    | 13 | Analog Channel Input Terminals                            |
| 5 | Analyse Key                   | 14 | Digital Channel Input (Type-C Interface) <sup>[1]</sup>   |

|   |   |    |   |
|---|---|----|---|
| 6 | Touch Lock Key                              | 15 | Dual-Channel Function/Arbitrary Waveform Generator Output Terminal <sup>[2]</sup> |
| 7 | Common Operation Keys                       | 16 | USB HOST Interface  |
| 8 | Quick Operation Key (Self-defined function) | 17 | Power Key   |
| 9 | Trigger Control Area                        |    |   |

**NOTE**

[1]: Digital channels are only available for MHO5054, MHO5104, MHO5056, and MHO5106 models.

[2]: Function/Arbitrary Waveform Generator (AFG) is the optional configuration only for MHO5054 and MHO5104 models.

## 4.5.2 Front Panel Function Overview

### 1. 10.1" capacitive touch screen

Displays the waveform, menu name, parameter setting, system state, prompt messages, etc.

### 2. Multifunction Knobs

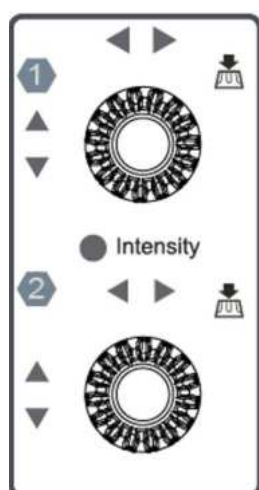

#### - Non-menu operation:

When not operating on the menu, you can rotate the knob 1 to adjust the waveform brightness. When a cursor, decoding, Math waveform, or reference waveform is added on the screen, you can rotate the multifunction knob (knob 1 and 2) to move the cursor, adjust the decode threshold (knob 1) and decode result display position (knob 2), adjust the vertical scale (knob 1) and vertical offset (knob 2) of the math/reference waveform. You can click or tap **Flex Knob** on the Toolbar at the upper-right of the screen to set the priority.

- Automatic: Cursor > (Math/Ref/Decode) > Intensity (default priority).

- Manual: all non-menu operation items are listed at the lower part of the **Flex Knob** menu. You can select one of them as the current item for the multifunction knob to adjust.

- **Menu operation:**

When operating on the menu, you can rotate the multifunction knob 1/2 to adjust the value in the menu. When you click or tap the input field and then the **1 / 2** icon is displayed in the input field, it indicates that you can use multifunction knob 1/2 to set the value. The LED indicator of the corresponding knob is illuminated. At this point, you can rotate the knob to adjust the value or press down the knob to restore the parameter to the default value.

When using the virtual numeric keypad or selecting from the drop-down list, you can rotate the knob to navigate through the keypad or drop-down list, then press down the knob to select an item.

### 3. Measure Key



: press this key to enter the "Measure" interface. You can set the measurement source, select the measurement item, etc.

### 4. Cursor Key



: press this key to enter the cursor measurement interface. The measurement results are displayed in the result list at the right section of the screen. This instrument provides three cursor modes: Manual, Track, and XY. XY mode is only available when the XY function is enabled.

### 5. Analyse Key



: press this key to enter the "Analyse" interface. You can click or tap "DVM", "Counter", "UPA", "Record", and "Pass/Fail" to enter the specified function interface.





### 6. Touch Lock Key

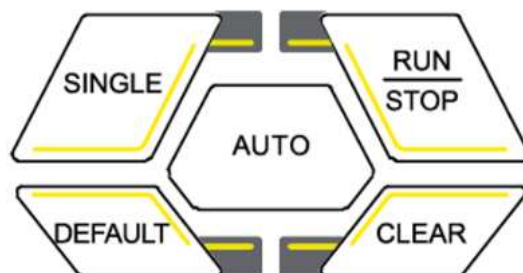

: press this key to disable the touch screen. Once disabled, press this key again to enable the touch screen.

### 7. Common Operation Keys







- : waveform auto setting key. Press this key to enable the waveform auto setting function. The oscilloscope will automatically adjust the vertical scale, horizontal time base, and trigger mode according to the input signal to realize optimal waveform display.
- : runs or stops the instrument. Press this key to set the operating state of the oscilloscope to "RUN" or "STOP". In the RUN state, the backlight of the key is illuminated in green. In the STOP state, the backlight of the key is illuminated in red.
- : single trigger key. Press this key to set the trigger mode to "Single".
- : default setting key. Press this key, and then a prompt message is displayed. Click or tap **OK** to restore the instrument to its default settings.
- : Clear key. Press this key to clear all the waveforms on the screen. If the oscilloscope is in the "RUN" state, new waveforms will continue being displayed.

## 8. Quick Operation Key

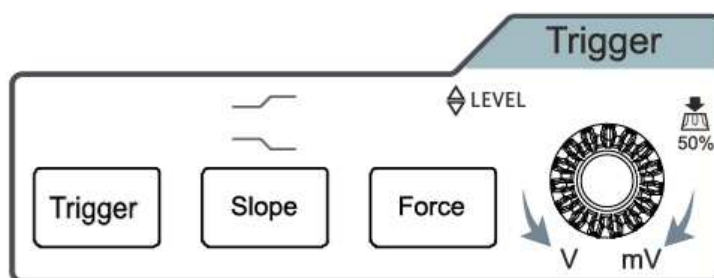
- : press this key to perform the quick operation for the specified function such as saving image, saving waveforms, saving setup files, performing All Measure function, resetting statistics, recording waveforms, and saving group.

## 9. Trigger Control Area





- : trigger setting key. Press this key to enter the "Trigger" interface.
- : trigger edge setting key. Press this key to switch the edge type (rising, falling, or either) of the Edge trigger signal. When the trigger type is not edge type, this key is unavailable to use.
- : force trigger key. Press this key to generate a trigger signal forcibly.
-  **LEVEL**: used to modify the trigger level/threshold level. Rotate it clockwise to increase the level, and rotate it counterclockwise to decrease the level. Press

down the knob to quickly set the trigger level/threshold level to 50% of the waveform peak-peak value.

## 10. Vertical Control Area

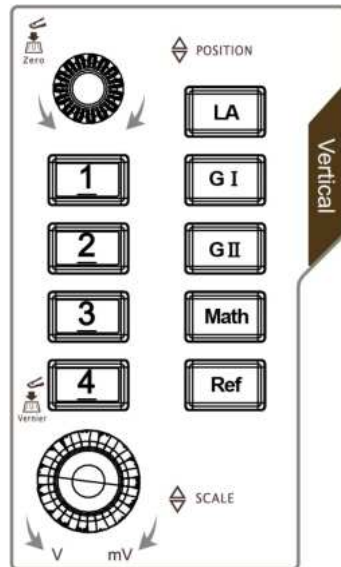
This part takes MHO5104 model that supports the digital channel and AFG function as an example to introduce the vertical control area on the front panel.



- **Vertical  POSITION**: channel vertical position knob. Rotate this knob to modify the vertical position of the waveform for the specified channel. The waveforms will move up and down on the screen. Press down the knob to reset the vertical position to zero.
- **Vertical  SCALE**: channel vertical scale knob. Rotate this knob to modify the amplitude of each vertical grid of the selected waveform, making its amplitude increase or decrease. Press down this knob, then you can rotate it to switch between the coarse and fine adjustment of the vertical scale.
- **Ref**: reference waveform key. Press this key to enter the reference waveform setting interface. The reference waveform is displayed in the waveform view. Compare the actual waveform with the reference waveform to locate the circuit failure problem.
- **Math**: math operation key. Press this key to enter the math operation interface. You can perform the math operations such as  $A+B$ ,  $A-B$ ,  $A \times B$ ,  $A/B$ , and FFT. Besides, you can also set the math operation label.
- **LA**: logic analyzer setting key. Press this key to open the logic analyzer control menu. You can enable or disable any channel or channel group, modify the waveform size of the digital channels, modify the threshold, group the 16 digital channels, etc. Besides, you can set the label for each digital channel.

- **GI**, **GII**: Function/Arbitrary Waveform Generator setting key. Press [**GI**] or [**GII**] on the front panel to enable or disable the output of the [**GI**] or [**GII**] connector, and enter the specified AFG interface.
- **1**, **2**, **3**, **4**: analog channel key. Press the specified key to enable or disable the specified channel.
  - If the channel is not displayed, you can press the channel key to open the channel in the waveform view window.
  - If the channel is displayed but not selected, you can press the channel key to select the channel.
  - If the channel is both displayed and selected, you can press the channel key to close its display in the waveform view.



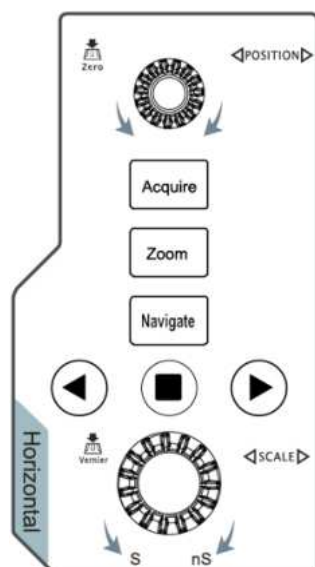

### 11. Probe Compensation Signal Output Terminal/Ground Terminal

This terminal outputs the probe compensation signal which helps you match a probe's input capacitance to the oscilloscope channel to which it is connected.

### 12. Horizontal Control Area



- **Horizontal POSITION**: horizontal position knob. Rotate this knob to modify the horizontal position (that is, trigger position), making the waveforms move left and right. Press down this knob to reset the horizontal position.
- **Horizontal SCALE**: horizontal scale knob. Rotate this knob to modify the horizontal time base of the waveform, then the displayed waveforms of all channels are expanded or compressed horizontally. Press down this knob, then you can rotate it to switch between the coarse and fine adjustment of the horizontal scale.

- : waveform acquisition setting key. Press this key to enter the acquisition and horizontal menu. You can set the time base mode, the acquisition mode, memory depth, and etc.
- : zoom key, also called the delayed sweep key. Press this key to enable or disable the delayed sweep function.
- : navigation key. Press this key to enter the navigation menu. You can set the navigation mode by time or search event.
- : navigation combination key.

### 13. Analog Channel Input Terminals

Used to connect the probe to input the analog signal.

### 14. Digital Channel Input (Type-C Interface)<sup>[1]</sup>

Four USB Type-C interfaces. They are used to connect the logic analyzer probe to input the digital signal.

### 15. Dual-channel Function/Arbitrary Waveform Generator Output Terminal<sup>[2]</sup>

Used to connect the Function/Arbitrary Waveform Generator signal. Press **[GI]** or **[GII]** on the front panel to enable or disable the output of the **[GI]** or **[GII]** connector, and enter the specified AFG interface. Note: This function is only available when the instrument has installed the MHO5000-AWG option.

### 16. USB HOST Interface

Supports FAT32 format Flash type USB storage device and the USB-GPIB module.

- **USB storage device:** imports or exports data (software update, waveform, setup, or captured image).
- **USB-GPIB module:** extends the GPIB interface for RIGOL instruments that integrates the USB HOST interface but not the GPIB interface.

### 17. Power Key

Powers on or off the instrument.

### 4.5.3 Rear Panel Overview

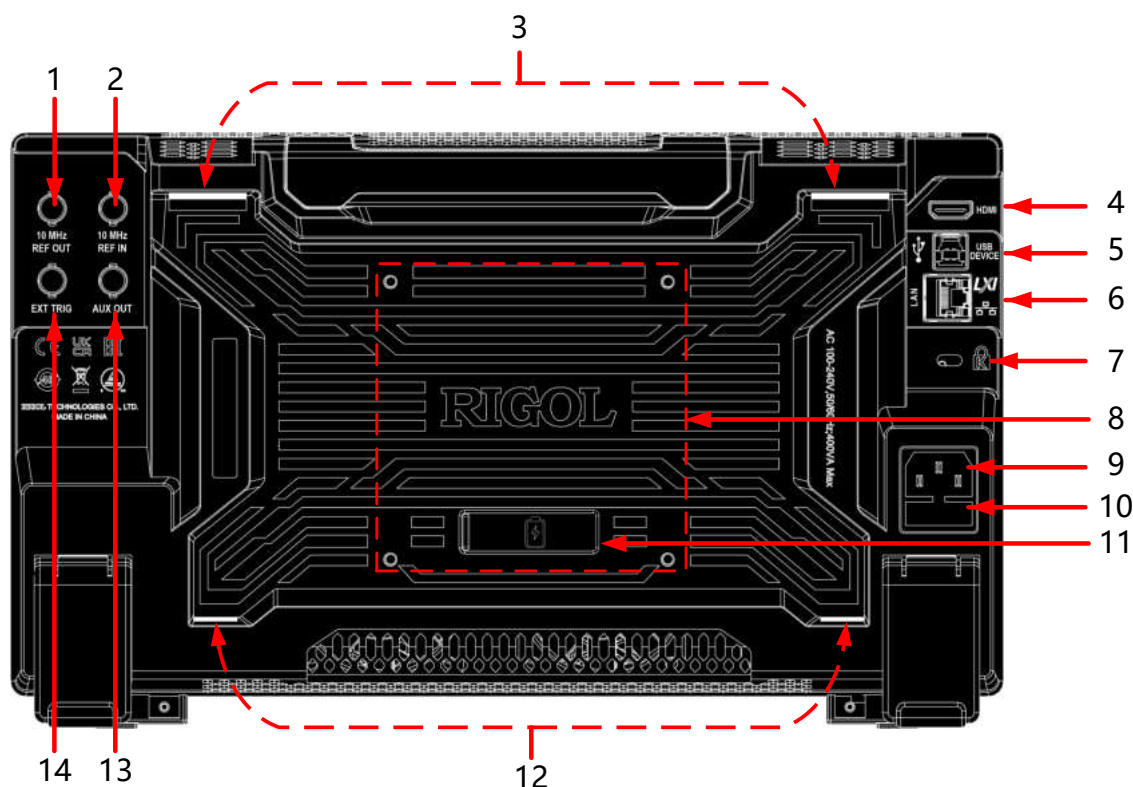

Figure 4.18 Rear Panel

#### 1. 10 MHz REF OUT

BNC connector that can output the 10 MHz clock signal generated by the internal crystal oscillator inside the instrument.

#### 2. 10 MHz REF IN

BNC connector to input external reference clock signal.

#### 3. Battery Pack Snap-Fit Slot

Used to insert the battery pack snap-fit part to fasten the battery pack.

#### 4. HDMI

You can connect the instrument to an external display that has the HDMI interface (e.g. monitor or projector) via this interface to better observe the waveform display clearly. At this time, you can also view the waveforms on the screen of the instrument.

#### 5. USB DEVICE

Connect the instrument to the PC via this interface. Then you can use the PC software to send the SCPI commands or use the user-defined programming to control the instrument.

## 6. LAN

Connect the instrument to network via this interface. The instrument conforms to the standards specified in *LXI Device Specification 2011*. Its test system can be built quickly. Then you can control the instrument through using Web Control to send the SCPI commands. When update is available, you can perform online upgrading for the system software of the instrument via the LAN interface.

## 7. Security Lock Hole

Use a standard PC/laptop lock cable to secure the oscilloscope to a work bench or other location.

## 8. Mounting Hole

Used for securing the bracket to the back of the instrument.

## 9. AC Power Cord Connector

The AC power requirements of the instrument are 100-240 V, 50-60 Hz. Please use the power cord provided in the accessories to connect the instrument to the AC power source.

## 10. Fuse

If you need to replace the fuse, use only the specified fuse.

## 11. Battery Pack Interface

Used to connect the battery pack.

## 12. Battery Pack Mounting Slot

Used to insert the brackets of the battery pack to fasten the battery pack.

## 13. AUX OUT

### - Trigger output:

When the AUX output is set to "TrigOut", the oscilloscope generates a trigger and outputs a signal that can reflect the current capture rate of the oscilloscope via this interface. Connect the signal to a waveform display device and measure the frequency of the signal. The measurement result is the same as the current capture rate.

### - Pass/Fail:

When the AUX output is set to "PassFail", in the pass/fail test, the instrument will output a pulse via the [AUX OUT] connector when a passed or failed waveform is detected during the pass/fail test.

## 14. EXT TRIG

BNC connector. The external trigger signal is input to the oscilloscope via this connector.

### 4.5.4 User Interface Overview

This chapter takes the MHO5104 model with digital channels and arbitrary waveform generator (AFG) features, and the eight-channel DHO5108 model as examples to introduce the user interface.

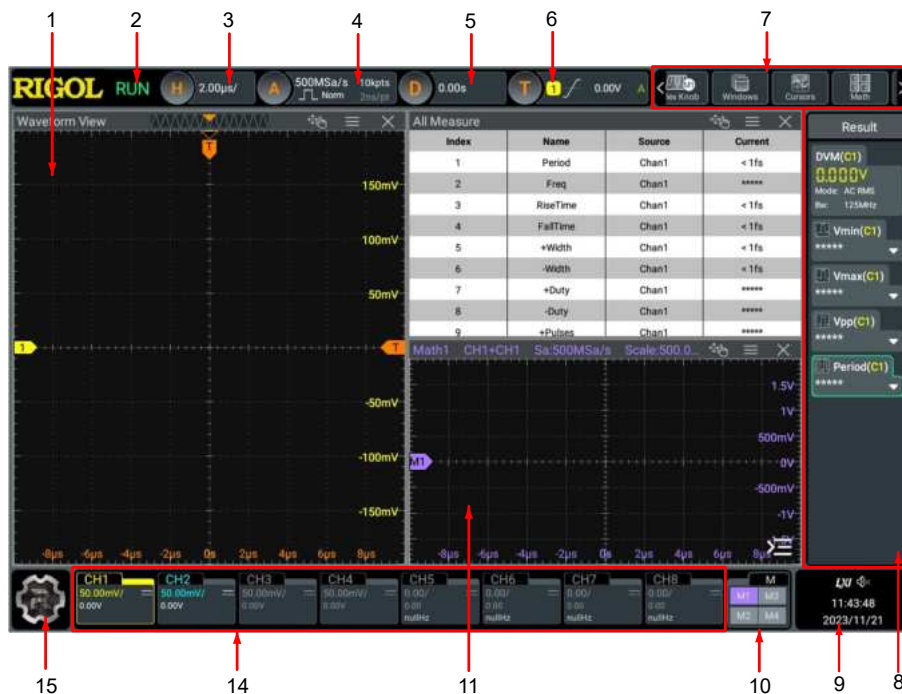



Figure 4.19 DHO5108 User Interface



Figure 4.20 MHO5104 User Interface

### 1. Waveform View

Displays the measurement waveform window of analog and digital channels. Click or tap  at the upper-right corner of the window to close the window; click or tap  to enter the configuration menu of the specified function.

### 2. Operating Status Label

Displays the operating status of the instrument.

### 3. Horizontal Timebase Label

Displays the current horizontal time base. Click or tap this label to enter the horizontal setting menu.

### 4. Sample Rate & Memory Depth Label

Displays the current sample rate and memory depth. Click or tap this label to enter the horizontal setting menu.

### 5. Horizontal Position Label

Displays the current horizontal position. Click or tap this label to enter the horizontal setting menu.

### 6. Trigger Label

- Displays the trigger information of the system, including the trigger type, trigger level, trigger mode, and etc.
- Click or tap the trigger label, then the trigger setting window is displayed. You can set the parameters for the trigger.

### 7. Quick Operation Toolbar



Provides **STOP/RUN**, **XY**, **Default**, **Flex Knob**, **Navigate** keys and some function keys in the function navigation menu for easy operation.



### 8. Result List

Displays the measurement results and statistics of various functions. Click or tap  at the lower-right corner of the screen to fold the "Result" list of the specified function.

### 9. Notification Area

Displays USB icon, LAN icon, sound icon, and remote control icon as well as date and time. You can click or tap this area to open the "Utility" menu.

- USB storage device icon: When a USB storage device is detected,  will be displayed.
- LAN icon: When the LAN interface is successfully connected,  is displayed.

- Sound icon: In the "Utility" menu, click or tap **Setup** > **Beeper** to enable or disable the sound. When on,  will be displayed; when off,  will be displayed. You can simply click or tap the icon to enable or disable the sound.
- Remote control icon: When you use Web Control to control the instrument remotely,  will be displayed.
- Date and time: Displays the system date and time. You can set them in the **Setup** menu.

## 10. Math Labels

Displays the on/off state, operation type, and vertical scale of Math1-Math4.

## 11. Digital Channel Labels<sup>[1]</sup>

Displays the on/off state of 16 digital channels. When a digital channel is enabled, click or tap this label to enter the logic analyzer (LA) setting menu.

## 12. Function/Arbitrary Waveform Generator Channels<sup>[2]</sup>

Displays the on/off state, waveform type, amplitude, and frequency for Arbitrary Waveform Generator GI/GII. Click or tap the label to enable/disable the AFG output. When the AFG output is enabled, click or tap this label to open the AFG setting menu.

## 13. Multi-pane Windowing

If you enable multiple functions, multiple windows can be displayed on the screen at one time.

## 14. Analog Channel Labels

- Displays the on/off status of analog channels (CH1-CH4/CH6/CH8).
- Displays the channel coupling mode.
- Displays the vertical scale of the channel.
- Displays the vertical offset of the channel.

## 15. Function Navigation Icon

Click or tap the icon to open the function navigation menu in which you can access the specified function menu by clicking or tapping the corresponding function key.

### NOTE

[1]: Digital channels are only available for MHO5054, MHO5104, MHO5056, and MHO5106 models.

[2]: Function/Arbitrary Waveform Generator (AFG) is the optional configuration only for MHO5054 and MHO5104 models.



## 4.6 Touch Screen Gestures

The instrument provides a capacitive touch screen, which is convenient for you to operate and make configurations. It has strong waveform display capability and excellent user experience. It features great convenience, high flexibility, and great sensitivity. The multi-capacitive touch screen supports gesture-enabled operation. The gestures supported by the touch screen controls include tapping, pinching & stretching, dragging, etc.

### 4.6.1 Tap

Use one finger to tap the symbol or characters on the screen slightly, as shown in *Figure 4.21*. With the Tap gesture, you can perform the following operations:

- Tap the menu displayed on the screen to operate on the menu.
- Tap the function navigation icon at the lower-left corner of the touch screen to enable the function navigation.
- Tap the displayed numeric keypad to set the parameters.
- Tap the virtual keypad to set the label name and the filename.
- Tap the close button at the upper-right corner of the message box to close the prompt window.
- Tap other windows on the touch screen and operate on the windows.



Figure 4.21 Tap Gesture

### 4.6.2 Pinch&Stretch

Pinch or stretch two points on the screen with two fingers to zoom in or out the waveform. To zoom in the waveform, first pinch the two fingers and then stretch the fingers; to zoom out the waveform, first stretch the two fingers, and then pinch the

fingers together, as shown in the figure below. With the pinch&stretch gesture, you can perform the following operation:

- Pinching&stretching in the horizontal direction can adjust the horizontal time base of the waveform.
- Pinching&stretching in the vertical direction can adjust the vertical scale of the waveform.



**Figure 4.22 Pinch&Stretch Gesture**

### 4.6.3 Drag

Use one finger to select the object, and then drag the object to a destination place, as shown in the figure below. With the drag gesture, you can perform the following operation:

- Drag the waveform to change its position or scale.
- Drag the window controls to change the position of the window (e.g. numeric keypad).
- Drag the cursor to move the cursor.
- Drag the trigger cursor to change the trigger level.
- In multi-window display, drag one of the displayed windows to change its position on the display.

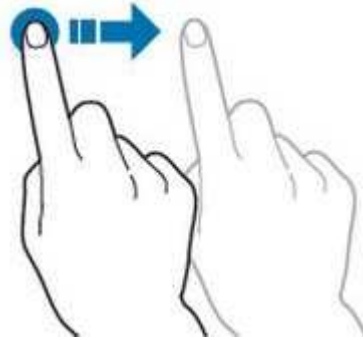

Figure 4.23 Drag Gesture

#### 4.6.4 Rectangle Drawing

Open the function navigation menu, and then click or tap the "DrawRect" icon to switch to the rectangle drawing mode. Drag a finger from upper left to lower right across the screen to draw a rectangle on the screen, as shown in [Figure 4.24](#). Move your finger away from the screen, and then a menu is displayed on the screen. At this time, you can tap to select "Trigger zone A", "Trigger zone B", "Histogram", "Horizontal zoom in", "Vertical zoom in", or "Waveform zoom in". Drag a finger from lower right to upper left across the screen to draw a rectangle on the screen, as shown in [Figure 4.25](#). Move your finger away from the screen, and then a menu is displayed on the screen. At this time, you can tap to select "Trigger zone A", "Trigger zone B", "Histogram", "Horizontal zoom out", "Vertical zoom out", or "Waveform zoom out".

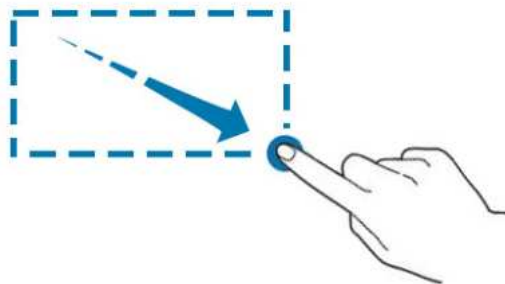
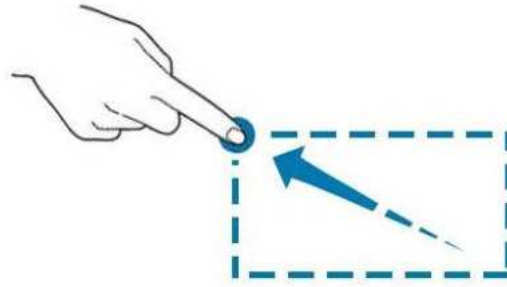



Figure 4.24 Rectangle Drawing Gesture (a)



**Figure 4.25 Rectangle Drawing Gesture (b)**

- Trigger zone A:
  - Draw the region for Trigger zone A;
  - Open Trigger zone A;
  - Open the "Zone Trigger" menu.
- Trigger zone B:
  - Draw the region for Trigger zone B;
  - Open Trigger zone B;
  - Open the "Zone Trigger" menu.
- Histogram:
  - Draw the region for the histogram;
  - Open the "Histogram" menu.
- Horizontal zoom in: expands the waveform in the horizontal direction. Horizontal zoom out: compresses the waveform in the horizontal direction.
- Vertical zoom in: expands the waveform in the vertical direction. Vertical zoom out: compresses the waveform in the vertical direction.
- Waveform zoom in: expands the waveforms both in the horizontal and vertical direction. Waveform zoom out: compresses the waveforms both in the horizontal and vertical direction.
- **TIP**  
Click or tap the "DrawRect" icon to switch between the rectangle drawing and waveform operation.



Click or tap the "DrawRect" icon, if  is highlighted, it indicates that the rectangle drawing mode is enabled. You can draw the rectangle to select the desired function. If  is displayed, it indicates that the waveform operation mode is enabled. By default, waveform operation mode is enabled.

## 4.7 Parameter Setting Method

The parameters can be set by using the knob or the touch screen. The common parameter setting methods are as follows:

- **Method 1:** Some parameters can be adjusted by rotating the knob on the front panel.
- **Method 2:** Click or tap the input field of a specified parameter, then a virtual keypad is displayed. Complete the parameter setting with the keypad.

### Input Chinese and English Characters

When naming a label, this instrument supports Chinese/English input method. The following part introduces how to input Chinese and English characters with the Chinese/English input method.

- **Input English Characters**

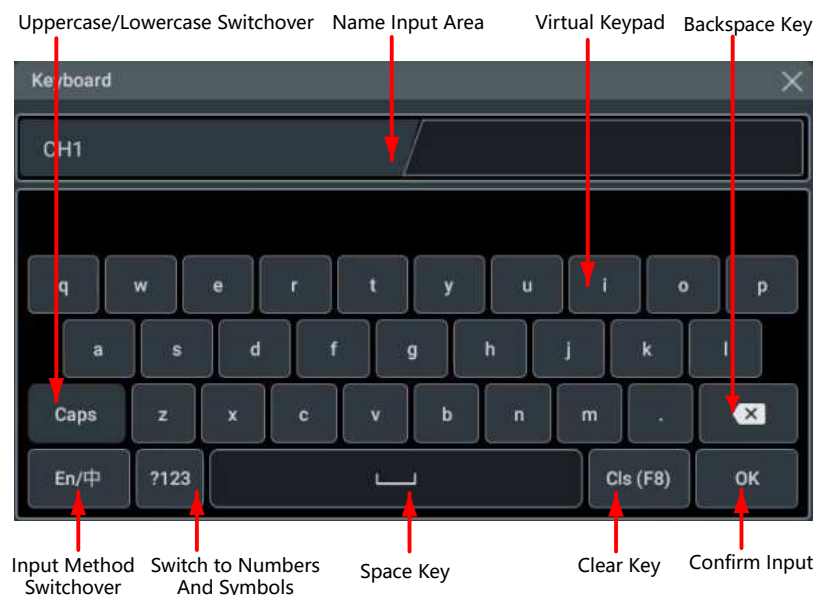

Figure 4.26 English Input Interface

### 1. Select English input method

First check the input method type. If it shows "En/中" currently, then go to Step 2; if it shows "中/En", click or tap the input method switchover key to switch to "En/中" (English input method).

## 2. Clear the name input area

If there is no character in the "Name Input Area", please go to the next step. If there are characters in the "Name Input Area", click or tap the Backspace key to delete all the characters from the "Name Input Area" in sequence.

## 3. Input the upper-case letter

If you want to input an upper-case letter, first use the Caps key to switch between the upper-case and lower-case mode. If the Caps key is selected, input the upper-case letter with the virtual keypad. If not, first click or tap the Caps key to ensure it is selected, then input the upper-case letter. All the input letters will be displayed in the "Name Input Area".

## 4. Input the lower-case letter

Refer to the operation specified in the previous step. If the Caps key is not selected, directly input the lower-case letter.

## 5. Input numbers or symbols

If the letter keypad is displayed, you need to click or tap the numeric switchover key to switch to the numeric keypad, and input numbers or symbols with the numeric keypad. All the input letters will be displayed in the "Name Input Area".

## 6. Modify or delete the unwanted characters that have been input

During the name input process, you can modify or delete the unwanted character if necessary. To delete the input characters, click or tap the Backspace key in the virtual keypad to delete the characters. To modify the characters that have been input, delete the unwanted characters first and then input the new characters.

You can directly move the cursor to the character to be modified or deleted, delete the desired character or input the new characters after deleting the unwanted character.

## 7. Confirm the input

After completing the input operation, click or tap "OK".

- **Input Chinese Characters**



**Figure 4.27 Chinese Input Interface**

### 1. Select Chinese input method

First check the input method type. If it shows "中/En" currently, then go to Step 2; if it shows "En/中", click or tap the input method switchover key to switch to "中/En" (Chinese input method).

### 2. Clear the name input area

If there is no character in the "Name Input Area", please go to the next step. If there are characters in the "Name Input Area", click or tap the Backspace key to delete all the characters from the "Name Input Area" in sequence.

If there are characters in the "Pinyin Input Area", when you delete characters from the name input area, the characters in the Pinyin input area will be deleted first.

### 3. Input Chinese characters

Click or tap the characters in the virtual keypad to input Pinyin into the input area, then the characters to be selected will be displayed in the Chinese character selection area. Slide to view more Chinese characters for you to choose. Select the desired Chinese character, and then the selected character will be displayed in the input area.

### 4. Modify or delete the unwanted characters that have been input

During the name input process, you can modify or delete the unwanted character if necessary. To delete the input characters, click or tap the Backspace key in the virtual keypad to delete the characters. To modify the characters that have been input, delete the unwanted characters first and then input the new characters.

### 5. Confirm the input

After completing the input operation, click or tap "OK".

### Input a Value

When setting or modifying a parameter, input an appropriate value with the numeric keypad.

- Click or tap the value or unit in the numeric keypad to complete the input.
- Rotate the specified multifunction knob (1 or 2) to move the cursor to select the value and unit. Press down the specified knob to input the selected value or unit.

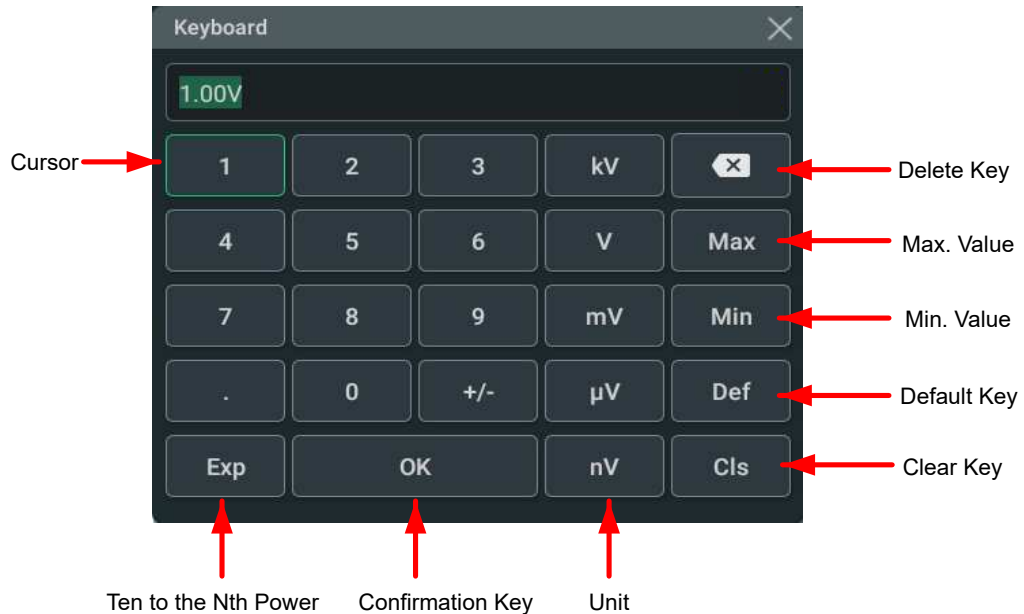

**Figure 4.28 Numeric Keypad**

After you input all the values and select the desired units, the numeric keypad is turned off automatically. This indicates that you have completed parameter setting. Besides, after you have input the values, you can also press OK directly to close the numeric keypad. At this time, the unit of the parameter is the default unit. In the numeric keypad, you can perform the following operation:

- Delete the parameter value that has been input;
- Set the parameter to a maximum or minimum value (sometimes, the maximum or minimum value are the specified one for the current state);
- Set the parameter to a default value;
- Clear the parameter input field.

## 4.8 To Use the Security Lock

If necessary, you can lock the instrument to a fixed location by using the security lock (please purchase it by yourself), as shown in the figure below.

The method is as follows: align the lock with the lock hole and plug it into the lock hole vertically, turn the key clockwise to lock the oscilloscope, and then pull the key out.

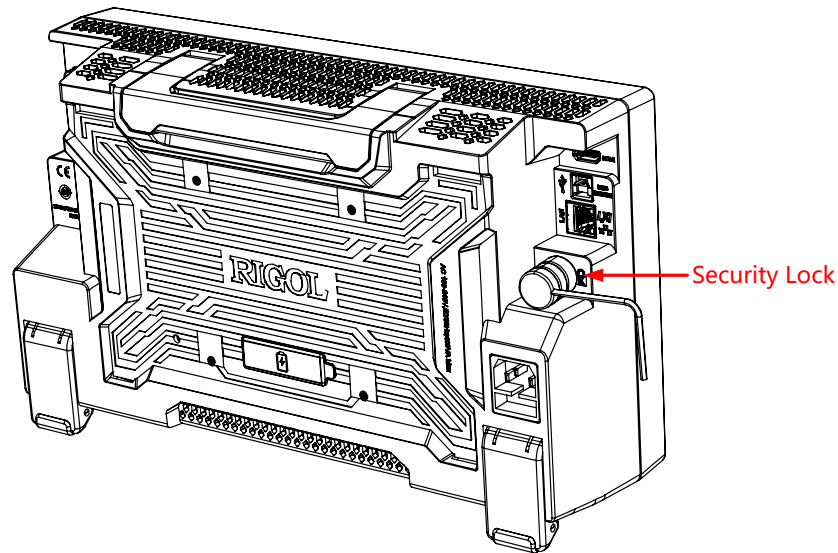

Figure 4.29 To Use the Security Lock



### CAUTION

Please do not insert other objects into the security lock hole to avoid damaging the instrument.

## 4.9 To Use the Built-in Help System

The built-in help file provides information about the functions and menu

introductions of the instrument. Click or tap  > **Help** to enter the help system.

In the help system, you can get its help information by clicking on or tapping the link for the specified chapter.

## 4.10 To View the Option Information and the Option Installation

This series oscilloscope provides multiple options to fulfill your measurement requirements. If you need any of these options, order them according to the Order No. available in "Appendix A: Options and Accessories", and then install the options

according to this section. Besides, you can also view the options currently installed on the oscilloscope or activate the newly purchased option.

### View the installed option

The instrument is installed with the trial versions of the options before leaving factory. You can use the option for a trial period of 2,160 minutes which is calculated starting from the first time you power on the instrument. Perform the following operations to view the option name and the option status.

- Click or tap the function navigation icon  at the lower-left corner of the screen, and then select **Utility** to enter the "Utility" menu.
- Click or tap **Options** to view the option list. If you have purchased and installed the option, it shows "Forever" state. If you haven't installed the specified option, it shows "Limit".

### Install the option

The option license is a string of fixed characters. Each instrument has one unique license. The license file should be in specific format, with the filename extension ".lic". After you purchase an option, you will obtain a key (used for obtaining the license). Then, you can install the option according to the following steps.

#### 1. Obtain an option license

- a. Log in to the RIGOL official website (<http://www.rigol.com>), click **SERVICE CENTRE > License Activation** to enter the license activation interface.
- b. Input the correct key, serial number (click or tap the function navigation icon  > **Utility > About** to acquire the serial number of the instrument), and verification code. Click **Generate** to acquire the option license.

#### 2. Install the option

Run the command :SYSTEM:OPTION:INSTall <license> to install the option. For detailed operations, refer to *MHO/DHO5000 Programming Guide*. Installing options by inputting the license code manually is not supported.

## 5 Vertical System

This oscilloscope provides eight analog input channels CH1-CH8. The vertical control system of each channel is independent of each other. The setting method for the vertical system of each channel is the same. This chapter takes CH1 as an example to introduce the setting method for the vertical system.

When a channel is selected, click or tap the channel status label at the bottom of the screen. Then the channel vertical setting menu is displayed.

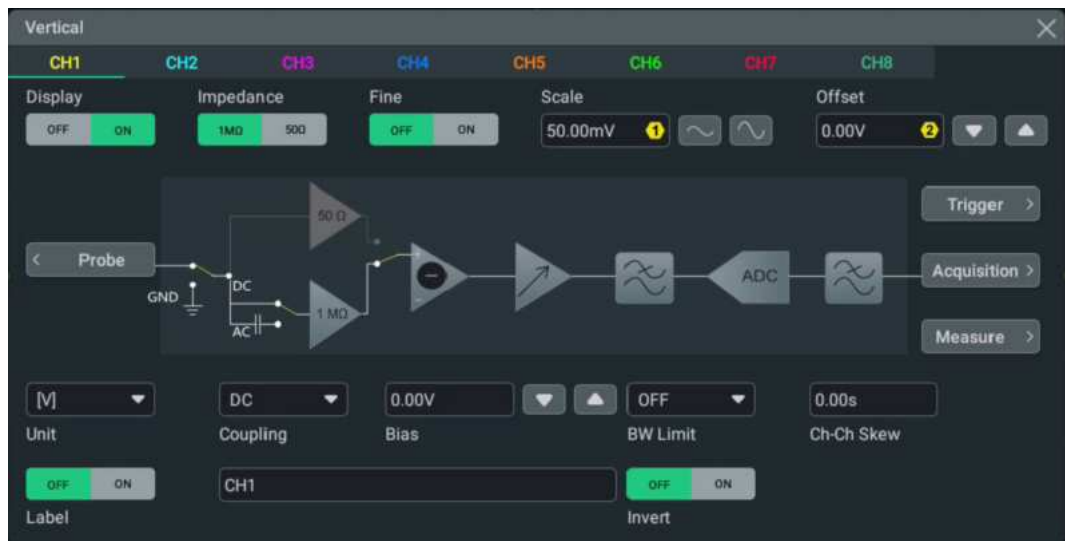



Figure 5.1 Vertical Menu

### 5.1 To Enable or Disable the Analog Channel

#### Enable the Analog Channel

When a signal is connected to CH1, you can enable the channel in the following ways.

- Click or tap the channel status label at the bottom of the screen to enable the channel.
- Press the front-panel  key to enable the channel, and the backlight of this key is illuminated.
- In the Vertical menu, select the CH1 tab. Select **ON** for the **Display** menu to turn CH1 on, and select **OFF** to turn CH1 off.

When CH1 is activated, its status label at the bottom of the screen is as shown in the figure below.



The information displayed in the channel status label is related to the current channel setting (irrelevant with the on/off status of the channel). After the channel is turned on, modify the parameters such as the vertical scale, horizontal time base, trigger mode, and trigger level according to the input signal for easy observation and measurement of the waveform.

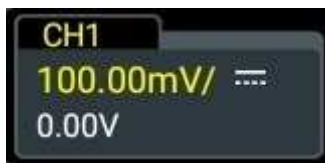

When CH1 is enabled but not activated, its status label is as shown in the following figure.



Click or tap the channel status label at the bottom of the screen or press the front-panel  key to activate CH1. You can also select the **CH1** tab in Vertical menu to activate it.

### Disable the Analog Channel

You can disable the analog channel in the following ways.

- If CH1 has been enabled and activated, you can press the front-panel  key to disable it directly. You can also click or tap the channel status label at the bottom of the screen to open the Vertical menu and then click or tap the label again to disable the channel.
- If CH1 has been enabled but not activated, first activate the channel. Then press the front-panel  key again to disable CH1. You can also click or tap the channel status label to disable CH1.
- You can also disable CH1 by setting **Display** to OFF in the Vertical menu.
- In addition, you can click or drag to slide down the channel label to disable the channel.

If CH1 is disabled, its status label is as shown in the figure below.



## 5.2 To Adjust the Vertical Scale

Vertical scale indicates the voltage value per grid in the vertical axis of the screen. It is often expressed in V/div. Adjusting the vertical scale increases or decreases the display amplitude of the waveform. The scale information of the channel status label at the bottom of the screen would change accordingly.



The adjustable range of the vertical scale is related to the current probe ratio and input impedance. By default, when (probe ratio x external attenuation ratio) is 1X and the input impedance is 1 MΩ, the range of the vertical scale is from 100 μV/div to 10 V/div.



### CAUTION

**When the vertical scale is less than or equal to 500μV, the bandwidth limit will be enabled automatically.**

When CH1 is turned on and activated, you can adjust the vertical scale in the following ways.

- Rotate the **Vertical SCALE** knob to adjust the vertical scale (clockwise to reduce the scale and counterclockwise to increase the scale).
- Enable the touch screen function, and then adjust the vertical scale with the pinch & stretch gesture on the touch screen. For details, refer to descriptions in *Pinch&Stretch*.
- In the **Vertical** menu, click or tap the icon at the right side of the input field of **Scale** to increase or decrease the scale value or use the specified multifunction knob on the front panel to set the value. You can also click or tap the input field to input a specific value with the displayed numeric keypad.

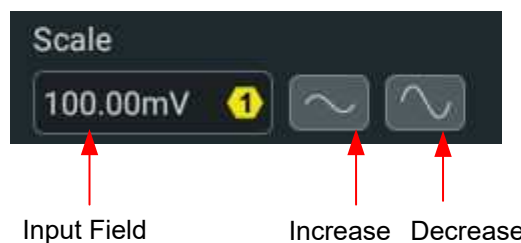

In the **Vertical** menu, click or tap the ON/OFF tab for **Fine** to toggle between **ON** (fine adjustment) and **OFF** (coarse adjustment). The default setting is OFF. You can also

press down the **Vertical SCALE** knob to toggle between "coarse adjustment" and "fine adjustment".

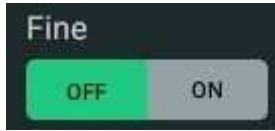

- **Fine adjustment:** Use the icons at the right side of **Scale** or rotate the knob to further adjust the vertical scale within a relatively smaller range to improve vertical resolution. If the amplitude of the input waveform is a little bit greater than the full scale under the current scale and the amplitude would be a little bit lower if the next scale is used, fine adjustment can be used to improve the amplitude of waveform display to view signal details.
- **Coarse adjustment:** Use the icons at the right side of **Scale** or rotate the knob to adjust the vertical scale in 1-2-5 step, i.e. 100  $\mu\text{V}/\text{div}$ , 200  $\mu\text{V}/\text{div}$ , 500  $\mu\text{V}/\text{div}$ , 1 mV/div, 2 mV/div, 5 mV/div, 10 mV/div...10 V/div.

## 5.3 To Adjust the Vertical Offset

Vertical offset indicates the offset of the signal ground level position of the waveform from the screen center in the vertical direction. Its unit is consistent with the currently selected amplitude unit (refer to *Amplitude Unit*). When adjusting the vertical offset, the waveforms of the corresponding channel moves up and down. The vertical offset information (as shown in the following figure) in the channel status label at the bottom of the screen will change accordingly.



The adjustable range of the vertical offset is related to the current input impedance, probe ratio, and vertical scale.

When CH1 is turned on and activated, you can adjust the vertical offset in the following ways.

- Rotate the **Vertical**  **POSITION** knob at the right section of the front panel to adjust the vertical offset within the adjustable range. Rotate this knob clockwise to increase the vertical offset or rotate it counterclockwise to reduce the vertical offset. Pressing down the knob can quickly reset the vertical offset (set the vertical offset to 0).
- Enable the touch screen function, and then adjust the vertical offset with the drag gesture. For details, refer to *Drag*.
- In **Vertical** menu, click or tap the Up/Down arrow icon at the right side of the input field of **Offset** to increase or decrease the offset value or use the specified multifunction knob to set the value. You can also click or tap the input field of **Offset** to input a specific value with the pop-up numeric keypad.



## 5.4 Channel Coupling

You can remove unwanted signals by setting the coupling mode. For example, the signal under test is a square waveform with DC offset.

Click or tap the channel status label at the bottom of the screen, and then the **Vertical** menu is displayed. Click or tap the drop-down button of **Coupling** to select the coupling mode.

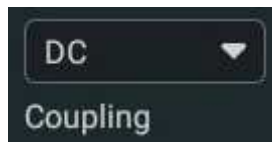

- When the coupling mode is "DC", both the DC and AC components of the signal under test can pass the channel.
- When the coupling mode is "AC", the DC components of the signal under test are blocked.
- When the coupling mode is "GND", the DC and AC components of the signal under test are blocked.

After a coupling mode is selected, it is indicated in the channel status label at the bottom of the screen, as shown in the figure below.

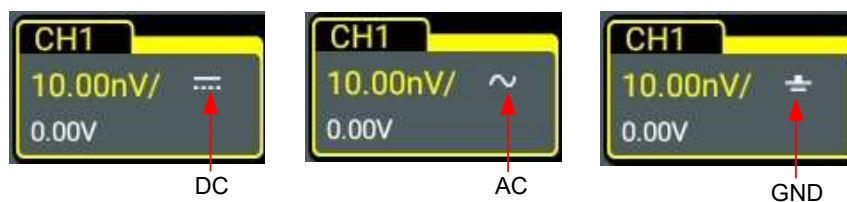

### TIP

When the input impedance is set to "50  $\Omega$ ", the channel coupling is set to DC coupling by force, and the **Coupling** menu is grayed out and cannot be modified.

## 5.5 Bandwidth Limit

This oscilloscope supports the bandwidth limit function. Setting the bandwidth limit can reduce the noises in the displayed waveforms. For example, the signal under test is a pulse with high frequency oscillation.

- When the bandwidth limit is turned off, the high frequency components of the signal under test can pass the channel.
- When the bandwidth limit is turned on, the high frequency components found in the signal under test that are greater than the limit are attenuated.

Click or tap the channel status label at the bottom of the screen, and then the **Vertical** menu is displayed. Click or tap the drop-down button of **BW Limit** to select the specified bandwidth. When the bandwidth limit is enabled, the specific bandwidth limit value will be displayed in the channel status label at the bottom of the screen, as shown in the figure below.



The supported bandwidth limits include 250 MHz and 20 MHz.

- When the vertical scale is greater than 500  $\mu\text{V}/\text{div}$ , you can turn off the bandwidth limit function.
- When the vertical scale is less than or equal to 500  $\mu\text{V}$ , the 250 MHz bandwidth limit is automatically enabled and the bandwidth limit cannot be turned off;
- When the vertical scale is less than or equal to 200  $\mu\text{V}$ , the 20 MHz bandwidth limit is automatically enabled and the bandwidth limit cannot be turned off.

## 5.6 Input Impedance

To reduce the circuit load between the oscilloscope and the circuit under test, this oscilloscope provides two input impedance modes: 1 M $\Omega$  (default) and 50  $\Omega$ . In the **Vertical** menu, click or tap to select "1 M $\Omega$ " or "50  $\Omega$ " for **Impedance**.

- 1 M $\Omega$ : In this mode, the input impedance of the oscilloscope is very high, and the current flowed from the circuit under test can be ignored.
- 50  $\Omega$ : makes the oscilloscope match the device whose output impedance is 50  $\Omega$ .

After the oscilloscope switches to the 50  $\Omega$  mode, the circuit diagram in the **Vertical** menu will also be changed, as shown in the figure below.

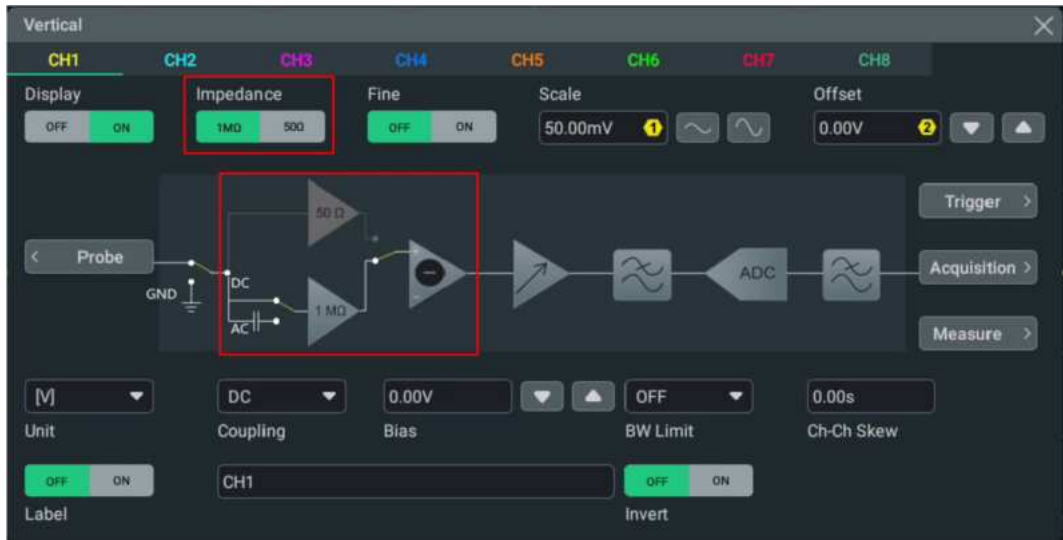

Figure 5.2 Input Impedance Switchover



#### TIP

- After the oscilloscope recognizes the probe automatically, the input impedance will also be auto recognized. You do not need to set it manually.
- Setting the input impedance affects the ranges of vertical scale and offset for the specified channel.

## 5.7 Waveform Invert

Click or tap the channel status label at the bottom of the screen. Then the **Vertical** system menu is displayed. Then click or tap the ON/OFF tab for **Invert** to enable or disable the waveform invert function.

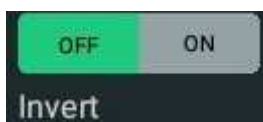

When "ON" is selected, the channel label is as shown in the figure below.



When "OFF" is selected, the waveform is displayed normally; when the waveform invert is enabled, the voltage values of the displayed waveform are inverted, as shown in the following figure below. Enabling the waveform invert will change the result of math function and waveform measurement.

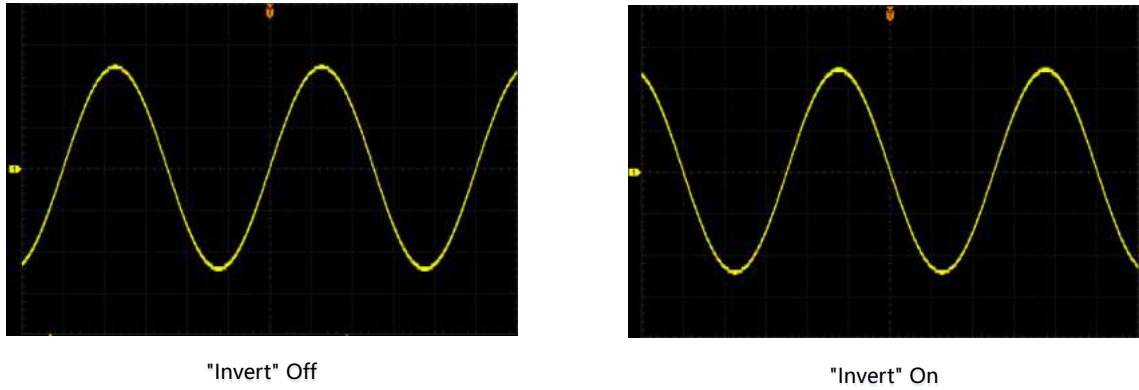

**Figure 5.3 Waveform Invert**



**TIP**

When the waveform invert is enabled, the trigger edge or the trigger polarity will change (e.g. Edge trigger, Pulse trigger, or Slope trigger).

## 5.8 Probe

The analog channel of this oscilloscope not only supports the common passive probe, but also the active probe. It can automatically recognize the currently connected probe type and its probe ratio. For detailed technical information of the probes, please refer to the corresponding Probe User Guide.

Enable the touch screen operation and tap the channel status label at the bottom of the screen. Then the **Vertical** system interface is displayed. Then tap **Probe** to enter the **Probe** setting menu.

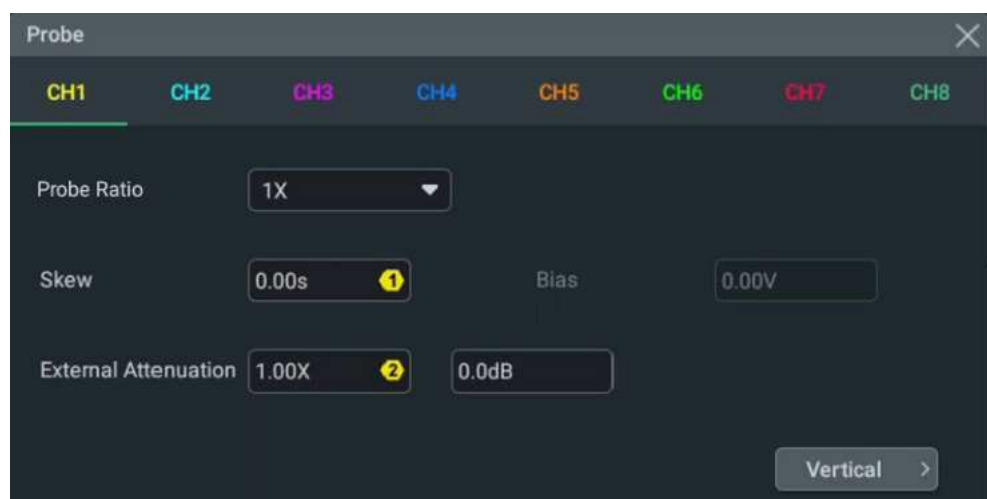

**Figure 5.4 Probe Setting Menu**

If the instrument works with RP7000/PVA7000 series probes (e.g. PVA7250), the probe ratio cannot be modified and you need to calibrate the probe. For specific probe models, please refer to *MHO/DHO5000 Data Sheet*. For detailed technical information of the probes, please refer to the corresponding Probe User Guide.

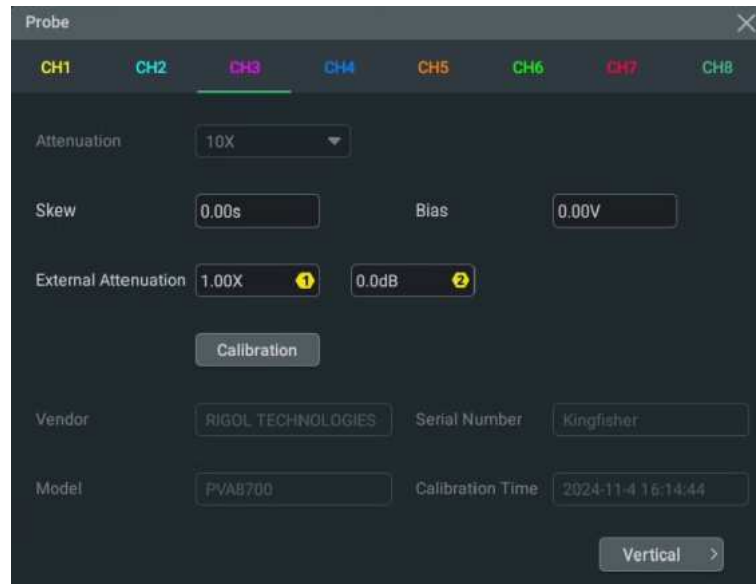

**Figure 5.5 Active Probe Setting Menu**

### Probe Ratio

The probe ratio is defined as the percentage of the voltage of the signal under test to the probe voltage output to the oscilloscope. The higher the probe ratio, the higher the probe sensitivity, indicating that more low-level signals can be detected.

- The series oscilloscope auto-recognizes certain probes with a fixed attenuation ratio. After being recognized, the probe ratio can be auto recognized. You do not have to set it manually.
- If the oscilloscope is unable to auto-recognize the probe, you are allowed to set the probe ratio manually. To obtain the correct measurement results, you must set the probe ratio properly. By default, the probe ratio is 1X.

The following table lists the preset probe ratio of the oscilloscope. You can also set a user-defined probe ratio according to your needs.

**Table 5.1 Probe Ratio**

| <b>Menu</b>  | <b>Attenuation (display amplitude of the signal: actual amplitude of the signal under test)</b> |
|--------------|---|
| 0.001X       | 0.001:1   |
| 0.002X       | 0.002:1   |
| 0.003X       | 0.003:1   |
| 0.005X       | 0.005:1   |
| 0.01X        | 0.01:1  |
| 0.02X        | 0.02:1  |
| 0.03X        | 0.03:1  |
| 0.05X        | 0.05:1  |
| 0.1X         | 0.1:1   |
| 0.2X         | 0.2:1   |
| 0.3X         | 0.3:1   |
| 0.5X         | 0.5:1   |
| 1X (default) | 1:1   |
| 2X           | 2:1   |
| 3X           | 3:1   |
| 5X           | 5:1   |
| 10X          | 10:1  |
| 20X          | 20:1  |
| 30X          | 30:1  |
| 50X          | 50:1  |
| 100X         | 100:1   |
| 200X         | 200:1   |
| 300X         | 300:1   |
| 500X         | 500:1   |
| 1000X        | 1000:1  |
| 2000X        | 2000:1  |
| 3000X        | 3000:1  |
| 5000X        | 5000:1  |

| Menu   | Attenuation (display amplitude of the signal: actual amplitude of the signal under test) |
|--------|--|
| 10000X | 10000:1  |
| 20000X | 20000:1  |
| 30000X | 30000:1  |
| 50000X | 50000:1  |

### External Attenuation

This oscilloscope allows you to set the external attenuation, supporting setting it in log format.

display amplitude of the signal under test = actual amplitude of the signal under test x probe ratio x attenuation ratio (not affect the actual amplitude of the signal)

**Table 5.2 Range of the External Attenuation**

| Probe Ratio | Max. Value            | Min. Value         |
|-------------|-----------------------|--------------------|
| ≤1          | 100kX                 | (10μ/Probe Ratio)X |
| >1          | (1000 x Probe Ratio)X | 10μX               |

### Skew

To avoid measurement result errors arising from the transmission delay of the probe cable, the oscilloscope provides the probe delay adjustment. Click or tap the input field of **Skew** to set the delay time of the probe with the pop-up numeric keypad. You can also use the specified knob to set it. Its range is from -100.00 ns to 100.00 ns. The default value is 0.00 s.

### Bias

The oscilloscope provides the bias voltage adjustment function for active probes. This function is used to adjust the signal under test that exceeds the input dynamic range of the probe amplifier to an appropriate range to ensure the integrity of the signal under test. When working with the RP7000/PVA7000 series probe, you need to click or tap the input field of **Bias** to set the bias voltage of the probe with the pop-up numeric keypad.

### Probe Information

After the oscilloscope recognizes the probe automatically, In the probe menu, you can view information about the currently connected probe, such as the vendor, model, serial number, and the last calibration time.

## Go Back to the Vertical System Menu

In the **Probe** setting menu, click or tap the **Vertical** menu to go back to the **Vertical** system menu.

## 5.9 Amplitude Unit

Click or tap the channel status label at the bottom of the screen. Then the **Vertical** system menu is displayed. Click or tap the drop-down button of **Unit** to select W, A, V, or U. The default unit is V.

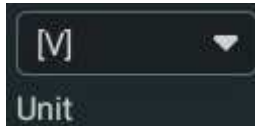

When the amplitude unit is changed, the unit related to the channel will also be changed accordingly.

## 5.10 Bias

When you use an oscilloscope to make actual measurements, a small offset that arises from the temperature drift of the component or external environment disturbance may occur on the zero-cross voltage of the channel, which will affect the measurement results of the vertical parameters. This series oscilloscope allows you to set an offset calibration voltage for calibrating the zero point of the corresponding channel, so as to improve the accuracy of the measurement results.

Click or tap the Up and Down arrow icon at the right side of the input field of **Bias** to increase or decrease the bias value. You can also click or tap the input field to input a specific value with the pop-up numeric keypad. Also, you can use the specified knob indicated in the input field to set the value.

Value Input Field    Decrease    Increase

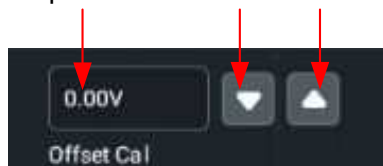

The range of bias voltage is related to the input impedance and the vertical scale.



### TIP

If the zero-cross voltage of the channel has a larger amplitude offset that exceeds the adjustable null range, please perform self-calibration for the instrument to ensure the measurement accuracy. For details, refer to descriptions in *SelfCal*.

## 5.11 Channel Delay

When using an oscilloscope for actual measurement, the transmission delay of the probe cable may bring relatively greater errors (zero offset). This series oscilloscope allows you to set a delay time for calibrating the zero offset of the corresponding channel. Zero offset is defined as the offset of the crossing point of the waveform and trigger level line relative to trigger position, as shown in the figure below.

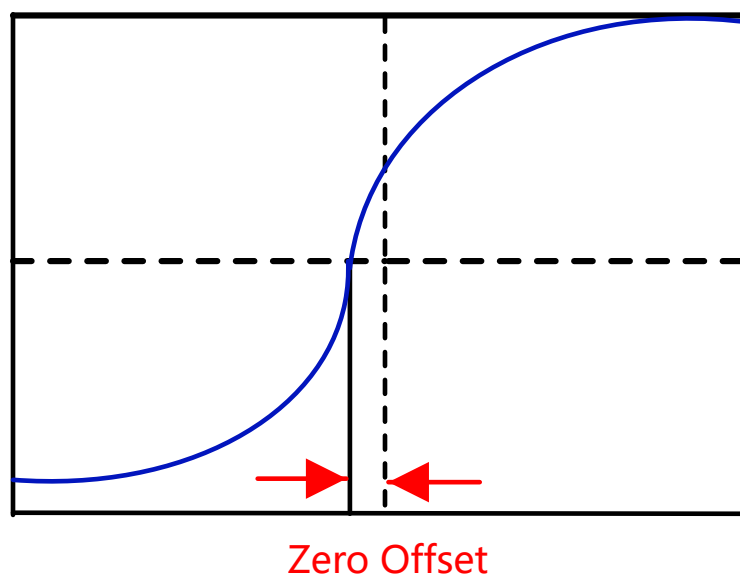

Figure 5.6 Zero Offset

In the "Vertical" menu, click or tap the input field for the **Ch-Ch Skew** item to set the channel-to-channel skew time. The available range is from -100 ns to 100 ns.

## 5.12 Channel Label

The instrument uses the channel number to mark the corresponding channel by default. For ease of use, you can also set a label for each channel. For example, **CH1**.

Click or tap the channel status label at the bottom of the screen. Then the **Vertical** system menu is displayed. Click or tap the ON/OFF tab for **Label** to select whether to display the channel label. You can also click or tap the channel label input field to input a specific name for the channel label with the pop-up numeric keypad.



## 6 Horizontal System

To enter the **Horizontal** system menu, perform any of the following operations:

- Press the front-panel horizontal controls  key to enter the **Horizontal** menu.
- Click or tap the channel status label at the bottom of the screen, and then the **Vertical** menu is displayed. Click or tap the **Acquisition** button to enter the **Horizontal** menu.
- Click or tap the horizontal time base label ("H" icon), acquisition label ("A" icon), or horizontal position label ("D" icon) at the top of the screen to enter the **Horizontal** menu.

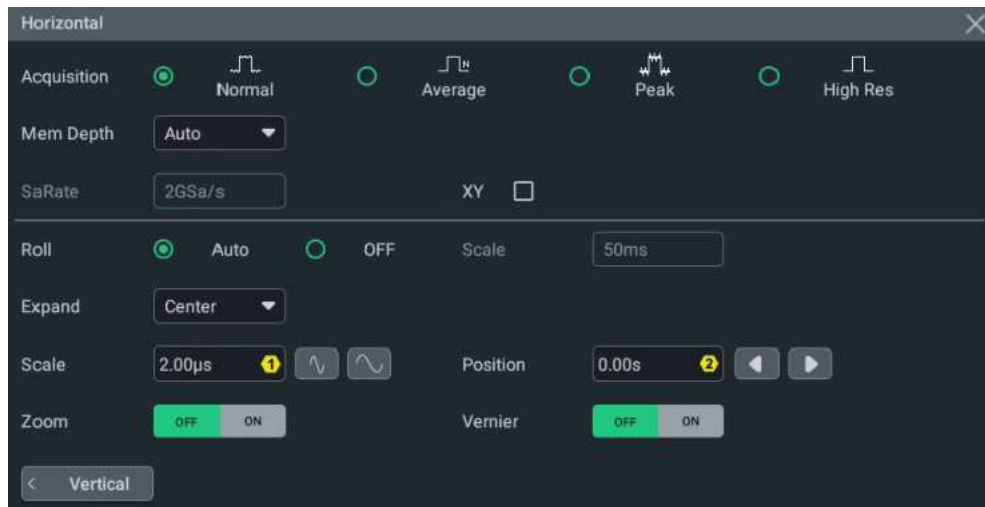
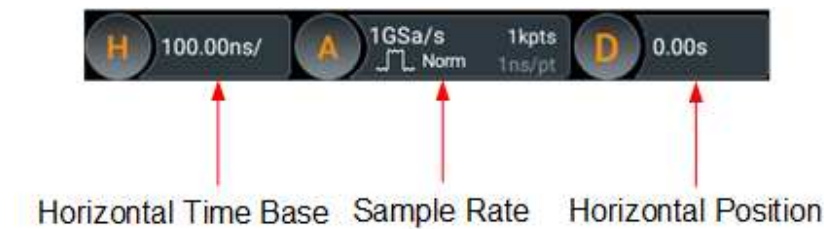

Figure 6.1 Horizontal System Menu

### 6.1 To Adjust the Horizontal Time Base

Horizontal time base, also called the horizontal scale, refers to the time of each grid in the horizontal direction of the screen. It is usually expressed in s/div. The range of the horizontal time base is from 200 ps/div to 500 s/div.

While you change the horizontal time base, the displayed waveforms of all channels are expanded or compressed horizontally relative to the selected time reference

(*Horizontal Expansion*). The horizontal time base in the horizontal time base label ("H" icon) will change accordingly, as shown in the figure below.



You can adjust the horizontal time base in the following ways.

- Rotate the front-panel **Horizontal SCALE** knob to adjust the horizontal time base (clockwise to reduce the scale and counterclockwise to increase).
- Enable the touch screen function, and then adjust the horizontal time base with the Pinch&Stretch gesture. For details, refer to *Pinch&Stretch*.
- In the **Horizontal** menu, click or tap the icon at the right side of the input field of **Scale** to increase or decrease the horizontal time base or use the corresponding multifunction knob to set the value. You can also click or tap the input field to input a specific value with the displayed numeric keypad.

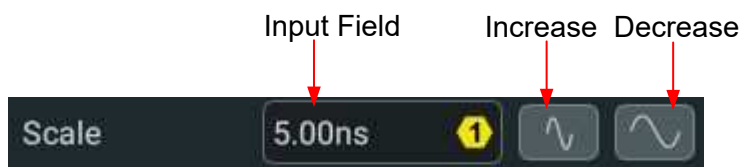

In the **Horizontal** menu, click or tap the ON/OFF tab for **Vernier** to toggle between ON (fine adjustment) and OFF (coarse adjustment). You can also press the front-panel

**Horizontal SCALE** knob to switch between "coarse adjustment" and "fine adjustment".

- **Coarse adjustment:** Click or tap the icons at the right side of the input field of **Scale** to adjust the horizontal time base of the waveforms of all channels in a 1-2-5 step sequence within the adjustable range.
- **Fine adjustment:** Click or tap the icon at the right side of the input field of **Scale** to adjust the horizontal time base of the waveforms of all channels at a smaller step within the adjustable range.

## 6.2 To Adjust the Horizontal Position

Horizontal position, also called trigger position, refers to the trigger point position of the waveforms of all channels in the horizontal direction relative to the screen center. When the waveform trigger point is at the left (right) side of the screen center, the horizontal position is a positive (negative) value.

While you change the horizontal position, the waveform trigger points and the displayed waveforms of all channels are moved left and right. The horizontal position at the top of the screen changes accordingly, as shown in the figure below.



You can adjust the horizontal position with the following methods.

- Rotate the front-panel **Horizontal POSITION** multifunction knob to adjust the horizontal position within the adjustable range. Rotate it clockwise to reduce the horizontal position, and counterclockwise to increase the horizontal position. Pressing down the knob can quickly reset the Horizontal position (set the horizontal position to 0).
- Enable the touch screen, and then adjust the horizontal position with the Drag gesture. For details, refer to *Drag*.
- Open the Horizontal system menu, rotate the specified front-panel multifunction knob indicated in the input field of **Position** or click/tap the icon at the right side of the input field to increase or decrease the value, as shown in the figure below. You can also click or tap the input field of **Position** to input a specific value with the displayed numeric keypad.

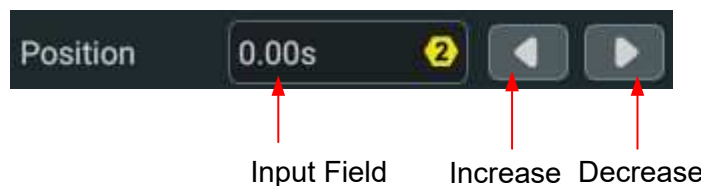

## 6.3 Zoom Mode (Delayed Sweep)

Zoom mode (delayed sweep) can be used to horizontally expand a length of waveform to view waveform details. In the **Horizontal** menu, click or tap the ON/OFF tab for **Zoom** to enable or disable the delayed sweep function. When it is enabled, you can set the scale and position in Zoom mode.



- **Zoomed Scale:** Rotate the corresponding multifunction knob or use the icons at the right of the **Scale** input field to increase or decrease the time base for the Zoom window. You can also click or tap the input field to input the specific value directly with the pop-up numeric keypad.
- **Zoomed Position:** Rotate the corresponding multifunction knob or use the icons at the right of the **Position** input field to increase or decrease the position for

the Zoom window. You can also click or tap the input field to input the specific value directly with the pop-up numeric keypad.

When the Zoom mode is enabled, the screen is divided into two display areas as shown in the figure below.



**Figure 6.2 Zoom Mode**

- Waveform before expansion:**

The upper portion of the display that is not covered by subtransparent gray shows the normal display of the waveform. Its horizontal time base (called the main time base) is indicated in the label at the upper-left corner of the display. You can move the area left and right by adjusting the horizontal position and increase or decrease the size of the area by adjusting the horizontal scale.
- Waveform after expansion:**

The lower portion shows the horizontally expanded version of the normal waveform display. Its horizontal time base (called the zoomed time base) is displayed in the middle. Compared with the main time base, the zoomed time base has higher horizontal resolution.

#### TIP

The zoomed time base should be smaller than or equal to the main time base.



## 7 Acquisition System

The "Horizontal" menu allows you to configure the instrument's acquisition system.

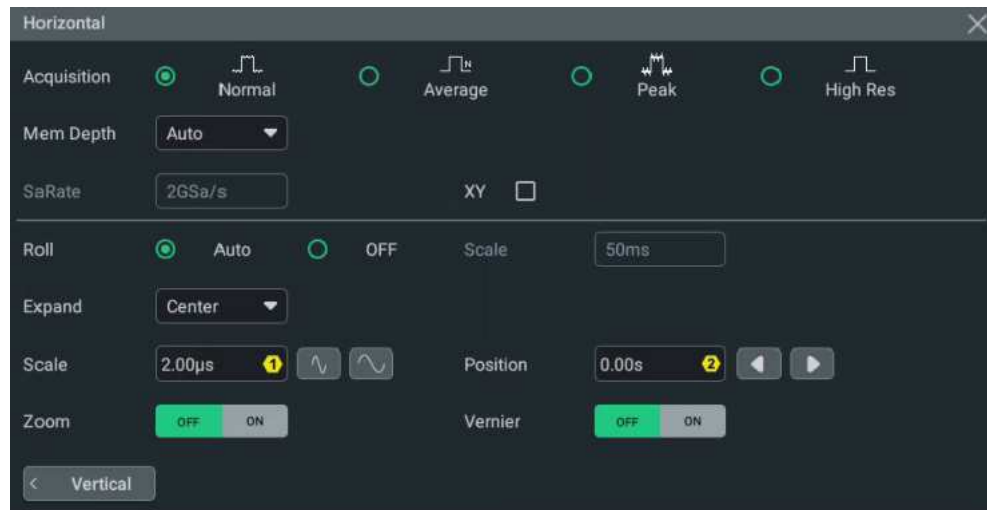

Figure 7.1 Horizontal Menu

### 7.1 Acquisition Mode

The acquisition mode is used to control how to generate waveform points from the sample points.

In the **Horizontal** menu, click or tap the desired acquisition mode for the **Acquisition** item. The available choices include Normal, Average, Peak, and High Res.

By default, the acquisition mode is Normal. The acquisition mode will be displayed in the acquisition label at the top of the screen.



#### Normal

In Normal acquisition mode, the oscilloscope samples the signal at a fixed time interval to rebuild the waveform. For most of the waveforms, this mode is adopted to achieve optimal display effects..

#### Average

In this mode, the oscilloscope averages the waveforms from multiple acquisitions to reduce the random noise of the input signal and increase the vertical resolution. A greater number of averages lowers the noise and increases the vertical resolution. On

the other hand, the higher the number of averages, the slower the response of the displayed waveform to waveform changes.

When you select "Average" mode, click or tap the **Averages** input field to set the number of averages with the pop-up numeric keypad or use the corresponding multifunction knob to set the value. Its range is from 2 to 65536, and the default is 2.

**TIP**

The number of averages must be the Nth power of 2. When it is not in N power-of-2 increments, a prompt message "Truncation average error" is displayed. At this time, a value that is smaller than the one you input and the closest to N power-of-2 increments will be input automatically.

**Peak**

In this mode, the oscilloscope acquires the maximum and minimum values of the signal within the acquisition interval to get the signal envelope or capture narrow pulses that might be lost.

In this mode, signal aliasing can be prevented, but the noise displayed would be larger.

In this mode, the min. detected pulse width is the sample period.

**High Resolution**

This mode uses a kind of ultra-sample technique to average the neighboring points of the sample waveform to reduce the random noise on the input signal and generate much smoother waveforms on the screen. This is generally used when the sample rate of the digital converter is higher than the storage rate of the acquisition memory.

When you select "High Res" mode, click or tap the drop-down button of **Bits** to select 14 (default) or 16. The bandwidth that corresponds to the selected bit is displayed at the right side of the input field of **Bits**.



**TIP**

- The averaging modes of the "Average" and "High Res" are different. The former uses "Multi-sample Average" and the latter uses "Single Sample Average".
- In "High Res" mode, the oscilloscope improves the measurement accuracy at the cost of bandwidth. Each time the sample rate changes, the current bandwidth is indicated at the right side of **Bits** in the horizontal system menu.

## 7.2 Sampling Mode

This oscilloscope only supports the real-time sampling mode. In this mode, the oscilloscope produces the waveform display from samples collected during one trigger event. The maximum real-time sample rate of this series is 4 GSa/s. The current sample rate is displayed in the acquisition label at the top of the screen.

By default, the operating status label at the left top of the screen is illuminated in green, indicating that the instrument is in real-time sampling, and the **STOP/RUN** button on the toolbar is in green. Click or tap the **STOP/RUN** button or press the

front-panel  key to stop sampling. At this time, the operating status label shows "STOP" in red, and the **STOP/RUN** button turns red. Also, the backlight of the front-panel  key turns red. The oscilloscope will maintain its last captured graph. You can still pan or zoom the waveforms by using the horizontal/vertical controls.

## 7.3 Sample Rate

Sampling is the process of converting an analog signal into digital data at a specified time interval and then storing them in sequence. The sample rate is the reciprocal of the time interval.

In **Horizontal** menu, the "SaRate" item shows the current sample rate. The current sample rate is also indicated in the acquisition label ("A" icon) at the top of the screen, as shown in the figure below.

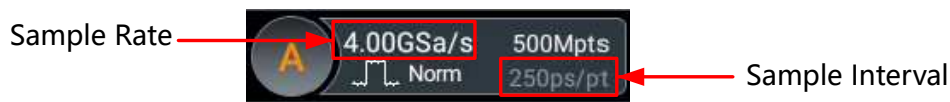

The maximum real-time sample rate of this series is 4 GSa/s, with DHO5058 and DHO5108 models supporting a maximum real-time sample rate of 2 GSa/s when all channels are enabled.

A sample rate that is too low might have the following effects on the waveform:

- **Waveform Distortion:** when the sample rate is too low, some waveform details are lost, and the sample waveform displayed is rather different from the actual waveform of the signal.

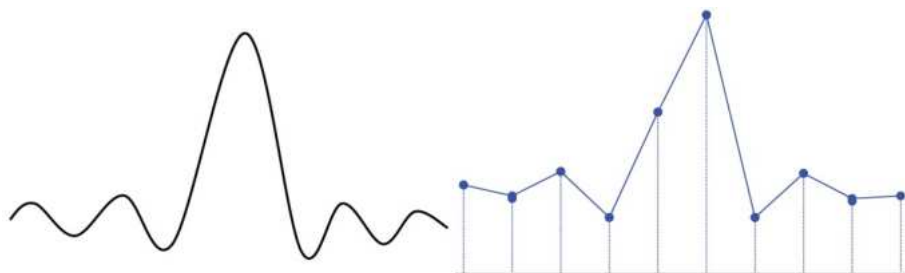

- **Waveform Aliasing:** when the sample rate is twice lower than the actual signal frequency (Nyquist Frequency), the frequency of the waveform rebuilt from the sample data is smaller than the actual signal frequency.



- **Waveform Leakage:** when the sample rate is too low, the waveform rebuilt from the sample data does not reflect all the actual signal information.

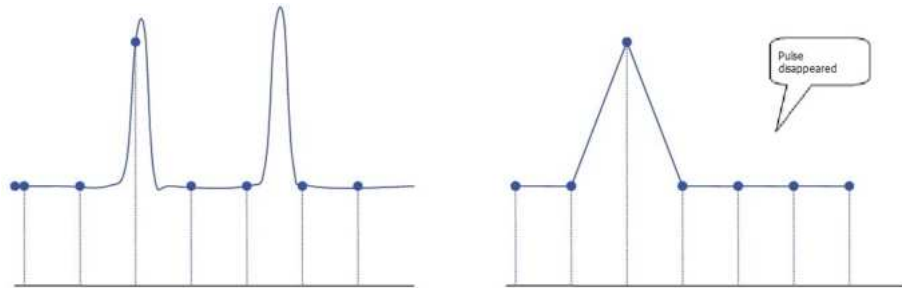

## 7.4 Memory Depth

Memory depth refers to the number of points that the oscilloscope can store in a single trigger acquisition. It reflects the storage capability of the acquisition memory. The MHO/DHO5000 series oscilloscope is equipped with a standard memory depth of up to 500 Mpts per channel.

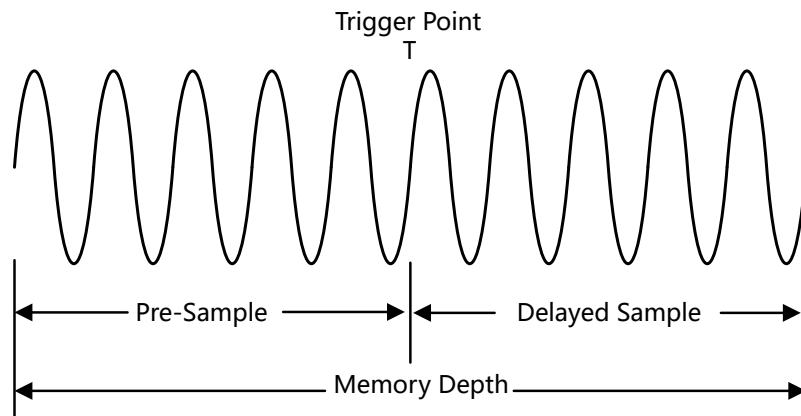

Figure 7.2 Memory Depth

$$MDepth \geq SRate \times TScale \times HDivs$$

The following formula shows the relations among memory depth, sample rate, and horizontal time base:

- **MDepth** indicates the memory depth. The unit is pts.
- **SRate** indicates the sample rate. The unit is Sa/s.
- **TScale** indicates the horizontal time base scale. The unit is s/div.
- **HDivs** indicates the number of grids in the horizontal direction. The unit is div.

Therefore, with the same horizontal time base, a higher memory depth can ensure a higher sample rate.

In the **Horizontal** system menu, click or tap the drop-down button of **Mem Depth** to select the memory depth. By default, the memory depth is "10 kpts". The memory depth value will be displayed in the sample rate label at the top of the screen.



- CH1, CH3, CH5, and CH7 are considered as one group; CH2, CH4, CH6, and CH8 are considered as another group.
- When one or multiple channels in either one of the group are enabled, the memory depths available include Auto, 1 kpts, 10 kpts, 100 kpts, 1 Mpts, 10 Mpts, 25 Mpts, 50 Mpts, 100 Mpts, 125 Mpts, 200 Mpts, 250 Mpts, and 500 Mpts.
- When one or multiple channels in both two groups are enabled, the memory depths available include Auto, 1 kpts, 10 kpts, 100 kpts, 1 Mpts, 10 Mpts, 25 Mpts, 50 Mpts, 100 Mpts, 125 Mpts, and 250 Mpts.

#### TIP

- In "Auto" mode, the oscilloscope selects the memory depth automatically according to the current sample rate.
- When **Acquisition Mode** is set to "High Res", "Auto" is not available for the memory depth setting.
- When **Acquisition Mode** is set to "Average", only 1 kpts, 10 kpts, 100 kpts, 1 Mpts, and 10 Mpts are available for the memory depth setting.

## 7.5 Horizontal Expansion

Horizontal expansion indicates the reference position that the screen waveform is referenced to when it is horizontally expanded or compressed in adjusting the horizontal time base.

In the **Horizontal** system menu, click or tap the drop-down button of **Expand** to select the horizontal reference baseline. The available choices include Center, Left, Right, Trigger, and User. The default is "Center".

- **Center:** when the horizontal time base is modified, the waveform will be expanded or compressed horizontally relative to the screen center.
- **Left:** when the horizontal time base is modified, the waveform will be expanded or compressed horizontally relative to the leftmost position of the screen.
- **Right:** when the horizontal time base is modified, the waveform will be expanded or compressed horizontally relative to the rightmost position of the screen.
- **Trigger:** when the horizontal time base is modified, the waveform will be expanded or compressed horizontally relative to the trigger point.
- **User:** when the horizontal time base is modified, the waveform displayed will be expanded or compressed horizontally relative to the user-defined reference position.

When you select "User", click or tap the input field of **User Expansion**. Input the horizontal expansion reference value with the displayed numeric keypad. Its range is from -500 to 500. Its default value is 0.

## 7.6 Roll Mode

The roll mode causes the waveform to move across the screen from right to left. It allows you to view the acquired data without waiting for a complete acquisition. In the **Horizontal** system menu, click or tap to select "Auto" or "OFF" for the **Roll** menu.

- **Auto:** the Roll mode is enabled. It is automatically enabled when the horizontal scale is 50 ms/div or slower.
- **OFF:** the Roll mode is disabled. The oscilloscope operates at slow sweep speeds when the horizontal scale is 200 ms/div or slower. In slow sweep mode, the oscilloscope acquires the data to the left of the trigger point and then waits for trigger. After the trigger occurs, it continues to acquire the data to the right of the trigger point. When you use this mode to observe low-frequency signals, it is recommended to set the channel coupling mode (*Channel Coupling*) to "DC".

### TIP

- If the Zoom mode is currently turned on, enabling the roll mode automatically turns off the Zoom mode.
- The following functions are not available when the roll mode is enabled:

*To Adjust the Horizontal Position* (available when the operating status of the oscilloscope is STOP), *Zoom Mode (Delayed Sweep)*, *To Trigger the Oscilloscope, Zoom Mode (Delayed Sweep)*, *Pass/Fail Test*, *Waveform Recording and Playing*, *Persistence Time*, *Average*, *XY Mode*.

## 7.7 XY Mode

By default, this series oscilloscope uses the YT mode for waveform display window. In YT mode, Y-axis indicates the Voltage and X-axis indicates the Time. Besides, it supports XY display window. In this display window, X-axis and Y-axis indicate voltage. The two input channels display from "Voltage-Time" to "Voltage-Voltage".

### Enable the XY Mode

You can enable the XY display mode in the following ways.

- Click or tap the **Windows** button in the function navigation menu or on the toolbar to enter the **Add Window** menu. In the "Diagram" item, click or tap **XY > Add** to enable the XY display mode.
- Click or tap the **XY** button in the function navigation menu or on the toolbar to enable the XY display mode.
- In the "Horizontal" menu, check the checkbox of **XY** to enable the XY mode.

### Configure the XY Mode

Click or tap  at the upper-right corner of the XY display window to enter the XY configuration menu.

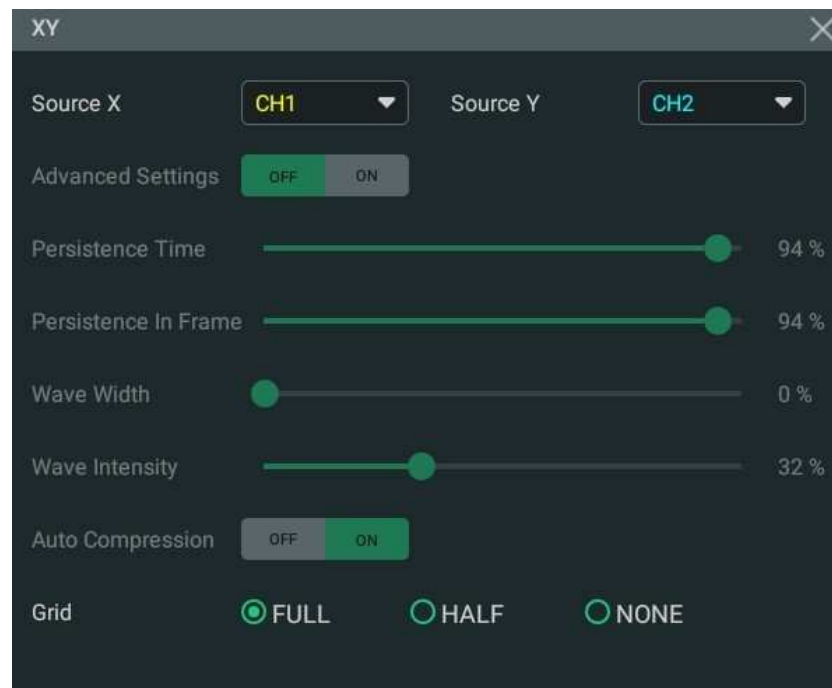

Figure 7.3 XY Menu

- **Source:** Click or tap the drop-down button of **Source X** to select the source channel of the X-axis in the XY window. Click or tap the drop-down button of **Source Y** to select the source channel of the Y-axis in the XY window.
- **Advanced Settings:** Click or tap the ON button for the Advanced Settings menu, you can configure the the following parameters with the slide bar.
  - Persistence Time: Refer to *Persistence Time*.
  - Persistence in Frame: controls the persistence time of the waveform in one frame.
  - Wave Width: controls the width of a single waveform.
  - Wave Intensity: Refer to *Waveform Intensity*.
- **Auto Compression:** when enabled, the waveform display effect can be optimized.
- **Grid:** Please refer to *To Set the Screen Grid* to set the grid of the XY window.



#### NOTE

Advanced settings are not currently available. The current settings, by default, are the optimal display effects.

#### Phase Deviation Measurement

In this mode, you can use the Lissajous method to measure the phase deviation of the two input signals whose frequencies are the same. The following figure shows the measurement schematic diagram of phase deviation.

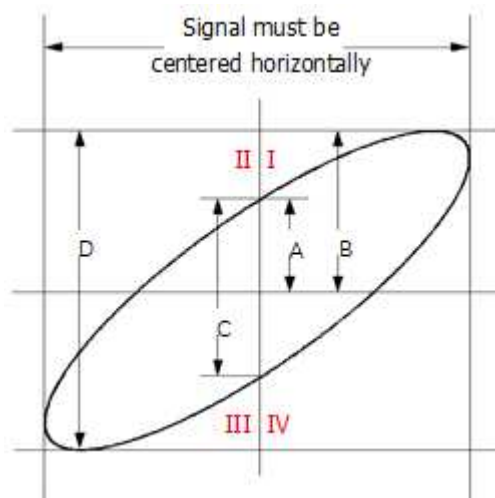

**Figure 7.4 Measurement Schematic Diagram of Phase Deviation**

According to  $\sin\theta = A/B$  or  $C/D$ ,  $\theta$  is the phase deviation angle between the two channels. The definitions of A, B, C, and D are shown in the figure above. The phase deviation angle is obtained, that is:

$$\theta = \pm \arcsin(A/B) \text{ or } \pm \arcsin(C/D)$$

If the principal axis of the ellipse is within Quadrant I and III, the phase deviation angle obtained should be within Quadrant I and IV, namely within  $(0 \text{ to } \pi/2)$  or  $(3\pi/2 \text{ to } 2\pi)$ . If the principal axis of the ellipse is within Quadrant II and IV, the phase deviation angle obtained should be within Quadrant II and III, namely within  $(\pi/2 \text{ to } \pi)$  or  $(\pi \text{ to } 3\pi/2)$ .

The XY mode can be used to measure the phase deviation occurred when the signal under test passes through a circuit network. Connect the oscilloscope to the circuit to monitor the input and output signals of the circuit.

## 8 To Trigger the Oscilloscope

The trigger system allows you to set specific trigger conditions as required. The oscilloscope captures a waveform and its neighboring part to display them on the screen once a particular trigger condition is met. For a digital oscilloscope, it samples waveforms ceaselessly no matter whether it is stably triggered. However, only stable triggering can guarantee the stable display of waveforms. The trigger module ensures that every time base sweep or acquisition starts from the user-defined trigger condition, namely every sweep is synchronous with the acquisition and the waveforms acquired are overlapped so as to display the stable waveforms.

You should set the triggers based on the features of the input signal. To quickly capture your desired waveforms, you need to understand the signal under test. This oscilloscope provides a variety of trigger types that help you focus on the desired waveform details.

You can enter the **Trigger** menu in the following ways.

- Press the front-panel  key to enter the trigger menu.
- In the Vertical menu, click or tap the **Trigger** button to enter the trigger setting menu.
- Click or tap the trigger label (as shown in the figure below) at the top of the screen to enter the trigger menu.

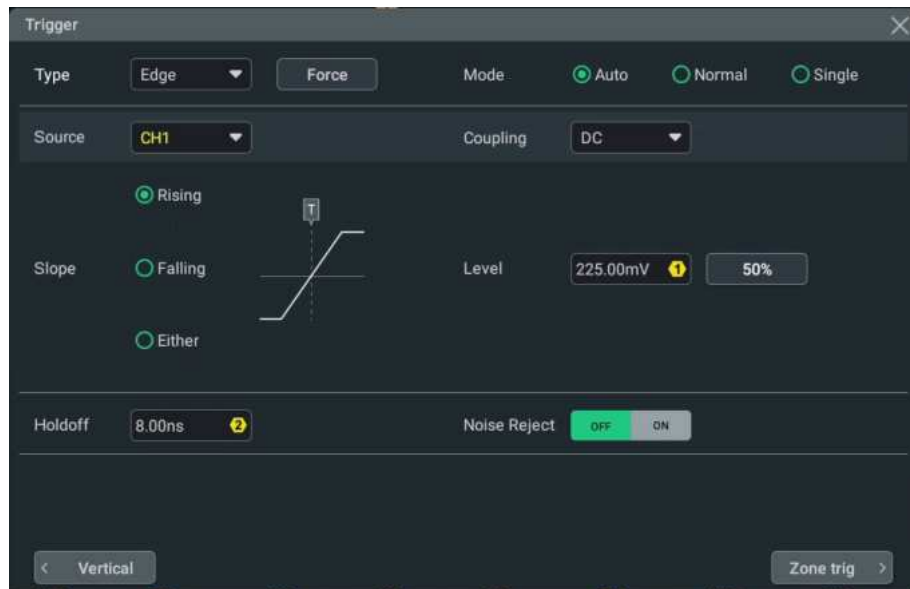

Figure 8.1 Trigger System Menu

## 8.1 Trigger Source

In the "Trigger" menu, click or tap the drop-down button of **Source** to select the desired source. The available sources include: analog channels, digital channels, EXT (external trigger), and AC Line.

### Analog Channel

All of the analog channels can be selected as the trigger source no matter whether the channel selected is enabled or not.

- DHO5058/DHO5108: CH1-CH8
- MHO5056/MHO5106: CH1-CH6
- MHO5054/MHO5104: CH1-CH4

### Digital Channel (Only for MHO Series)

All of the digital channels (D0-D15) can be selected as the trigger source no matter whether the channel selected is enabled or not.

### AC Line

AC power of the oscilloscope can be used as trigger source. AC trigger is usually used to measure signals relevant to the AC power frequency. For example, stably triggering the waveform output from the transformer of a transformer substation. It is mainly used in the power industry-related measurements.

### EXT (External Trigger)

The external trigger source can be used to trigger on the ninth channel while all of the 8 channels are acquiring data. The trigger signal (e.g. external clock or signal of the circuit under test) will be input to the **EXT** trigger source via the **[EXT TRIG]** external trigger input connector. You can set the trigger conditions within the range of the trigger level -8 V to +8 V).

## 8.2 Trigger Level



Trigger level determines the position of the trigger point on the edge. The adjustment of the trigger level is related to the type of the trigger source.

- When the trigger source is analog channel or digital channel, rotate the front-panel  **LEVEL** knob or use the corresponding multifunction knob (when the trigger menu is opened) to adjust the trigger level. You can also click or tap the input field of **Level** to set the value with the pop-up numeric keypad.

When the trigger source is D0-D15, you can set the threshold level for digital channels in the basic settings tab of the logic analyzer interface shown in *Figure*

*12.1*. For details, refer to *To Set the Threshold*. The current threshold level is displayed in the trigger information label at the top of the screen.

During the adjustment, a trigger level line (the color of the trigger level line is the same as that of the channel) and a trigger icon " " are displayed on the screen, and they move up and down with the variation of the trigger level. When you stopping modifying the trigger level, the trigger level line disappears in about 2s. The current trigger level is displayed in the trigger information label at the top of the screen.

In Runt Trigger, Slope Trigger, and Window trigger, you need to set the upper and lower limits of the trigger level. Two trigger level icons  and  are displayed at the right section of the screen.

- When the trigger source is AC Line, there is no trigger level.
- When the trigger source is EXT, rotate the front-panel  **LEVEL** knob or use the corresponding multifunction knob (when the trigger menu is opened) to adjust the trigger level. You can also click or tap the input field of **Level** to set the value with the pop-up numeric keypad. The current trigger level is displayed in the trigger information label at the top of the screen.

For this trigger source, only the variation of the trigger level value is displayed on the screen during the adjustment of the trigger level, without displaying the trigger level lines on the screen.

To better trigger the waveforms, for a trigger with a single level, you can directly click or tap **50%** in the menu or press the trigger level knob to make the level move to the middle of the waveform. However, for a trigger with two levels (e.g. Slope trigger, Runt trigger, Window trigger and MIL-STD-1553 trigger), you need to click or tap **90%** for Level A and **10%** for Level B to make the level move within the range of the waveform amplitude.

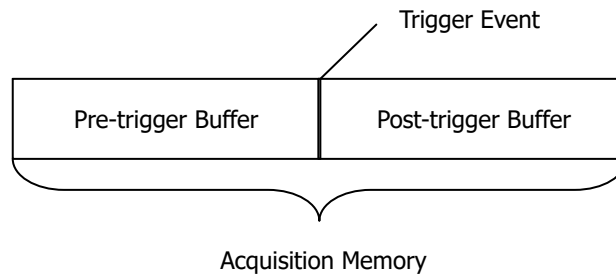

## 8.3 Trigger Mode

The following is the schematic diagram of the acquisition memory. To easily understand the trigger event, we classify the acquisition memory into the pre-trigger buffer and post-trigger buffer.



**Figure 8.2 Schematic Diagram of the Acquisition Memory**

After the oscilloscope starts running, it first fills the pre-trigger buffer. Then, after the pre-trigger buffer is filled, the oscilloscope starts searching for a trigger. While searching for the trigger, the data sampled will still be transmitted to the pre-trigger buffer (the new data will continuously overwrite the previous data). When a trigger is found, the pre-trigger buffer contains the events that occurred just before the trigger. Then, the oscilloscope will fill the post-trigger buffer and display the data in the acquisition memory.

If the acquisition is initiated via the front-panel  key, the oscilloscope will repeat this process. If the acquisition is initiated via , the oscilloscope will stop after finishing a single acquisition (you can pan and zoom the currently displayed waveform).

This series oscilloscope provides Auto, Normal, and Single trigger modes. The default trigger mode is Auto.

Click or tap the trigger information label in the main interface (as shown in the figure below) to enter the trigger setting interface. You can also press the front-panel

 key to enter the trigger setting interface. Then select the desired trigger mode under **Mode**. The trigger mode is displayed in the trigger information label at the top of the screen: A (Auto), N (Normal), and S (Single).



- **Auto:** In this trigger mode, if the specified trigger conditions are not found, triggers are forced and acquisitions are made so as to display the waveforms. This trigger mode should be used when the signal level is unknown or the DC should be displayed as well as when forcible trigger is not necessary as the trigger condition always occurs.
- **Normal:** In this trigger mode, triggers and acquisitions only occur when the specified trigger conditions are found. This trigger mode should be used when the signal is with low repetition rate or only the event specified by the trigger

setting needs to be sampled as well as when auto trigger should be prevented to acquire stable display.

- **Single:** In this trigger mode, the oscilloscope performs a single trigger and acquisition when the specified trigger conditions are found, and then stops. This trigger mode should be used when you need to perform a single acquisition of the specified event and analyze the acquisition result (you can pan and zoom the currently displayed waveform, and the subsequent waveform data will not overwrite the current waveform). After a single trigger mode is initiated, the operating status of the oscilloscope is in "STOP" state.

When the trigger mode is **Normal** or **Single**, click or tap Force in the trigger setting interface to generate a trigger signal forcibly. You can also press the front-panel



to generate a trigger signal forcibly.

## 8.4 Trigger Coupling

Trigger coupling decides which kind of components will be transmitted to the trigger module. Please distinguish it from channel coupling (*Channel Coupling*). This function is available only when the trigger type is Edge and the trigger source is an analog channel.

In the "Trigger" menu, click or tap the drop-down button of **Coupling** to select the desired coupling mode (by default, it is DC).



- **DC:** allows DC and AC components to pass the trigger circuitry.
- **AC:** blocks the DC components and attenuates the signals.
- **LFR:** blocks the DC components and rejects the low-frequency components.
- **HFR:** rejects the high frequency components.

### TIP

When "AC" or "LFR" is selected as the coupling mode, no trigger level lines and trigger icons are displayed. When you adjust the trigger level, you can only see the changes of the trigger level values in the trigger information label at the top of the screen.



## 8.5 Trigger Holdoff

Trigger holdoff can be used to stably trigger on complex repetitive waveforms that have multiple edges or other events between waveform repetitions (such as pulse series). Holdoff time indicates the time that the oscilloscope waits for re-arming the

trigger module after generating a correct trigger. The oscilloscope will not trigger even if the trigger condition is met during the holdoff time and will only re-arm the trigger module after the holdoff time expires.

For example, to stably trigger the repetitive pulse series as shown in the figure below, the holdoff time should be set to a value that is greater than  $t_1$  and smaller than  $t_2$ .

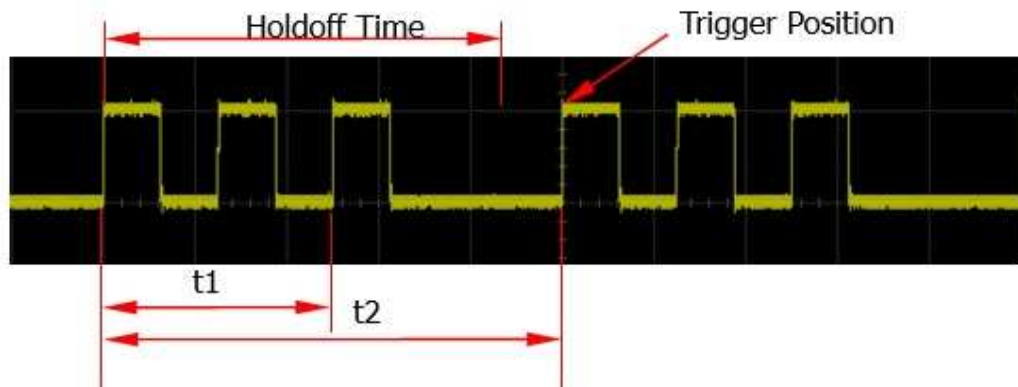

Figure 8.3 Trigger Holdoff

In the trigger interface, click or tap the input field of **Holdoff** to set the holdoff time with the pop-up numeric keypad to make it to trigger stably. By default, it is 8 ns. You can also rotate the specified multifunction knob indicated in the input field to set the value. The adjustable range of the holdoff time is from 8 ns to 10 s.

## 8.6 Noise Rejection

Noise rejection can reject the high frequency noise in the signal and reduce the possibility of miss-trigger of the oscilloscope.

Click or tap the ON/OFF tab for **Noise Reject** to enable or disable the noise rejection.



### TIP

This function is only valid when the trigger source is an analog channel, digital channel, or EXT.

## 8.7 Trigger Type

This series oscilloscope provides the following trigger types.

### 8.7.1 Edge Trigger

Identifies a trigger on the trigger level of the specified edge on the input signal.

### Set the Trigger Type

Click or tap the drop-down button of **Type** to select "Edge".

For the Edge trigger menu, refer to [Figure 8.1](#).

After a trigger type is selected, the current trigger setting information (including the trigger type, source, and level) is displayed in the trigger information label at the top of the screen, as shown in the figure below. The information will change based on the trigger settings.



### Select the Source

Click or tap the drop-down button of **Source** to select analog channel, digital channel, AC Line, or EXT. For the available channels, refer to descriptions in [Trigger Source](#). The selected trigger source is indicated in the trigger information label at the top of the screen.

Only when you select the channel (that has been input with signals) as the trigger source, can you obtain a stable trigger.

### Edge Type

In the **Slope** item, select which edge of the input signal will trigger the oscilloscope. The selected slope will be indicated in the trigger information label.

- Rising: triggers on the rising edge of the input signal when the voltage level meets the specified trigger level.
- Falling: triggers on the falling edge of the input signal when the voltage level meets the specified trigger level.
- Either: triggers on the rising or falling edge of the input signal when the voltage level meets the preset trigger level.

### TIP

When edge trigger is selected, you can also press the front-panel  key to switch the edge type.



## 8.7.2 Pulse Trigger

Triggers on the positive or negative pulse with a specified width. In this mode, the oscilloscope will trigger when the pulse width of the input signal satisfies the specified pulse width condition.

In this oscilloscope, positive pulse width is defined as the time difference between the two crossing points of the trigger level and positive pulse; negative pulse width is

defined as the time difference between the two crossing points of the trigger level and negative pulse, as shown in the figure below.

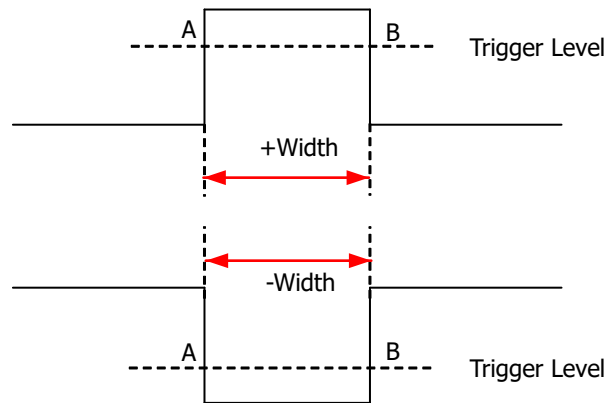

**Figure 8.4 Positive/Negative Pulse Width**

### Trigger Type

Click or tap the drop-down button of **Type** to select "Pulse".



**Figure 8.5 Pulse Trigger Setting Menu**

After a trigger type is selected, the current trigger setting information (including the trigger type, source, and level) is displayed in the trigger information label at the top of the screen, as shown in the figure below. The information will change based on the trigger settings.





### Select the Source

Click or tap the drop-down button of **Source** to select the analog channel or the digital channel as the trigger source. For available channels, refer to descriptions in *Trigger Source*. The selected trigger source is indicated in the trigger information label at the top of the screen.

Only when you select the channel (that has been input with signals) as the trigger source, can you obtain a stable trigger.

### Polarity

In the **Polarity** item, select the desired polarity: positive polarity () or negative polarity ()

### Trigger Condition

Set the trigger condition in the **When** item.

- When you select "Positive" for polarity, ">" for trigger condition, the oscilloscope triggers when the positive pulse width of the input signal is greater than the specified pulse width.
- When you select "Positive" for polarity, "<" for trigger condition, the oscilloscope triggers when the positive pulse width of the input signal is smaller than the specified pulse width.
- When you select "Positive" for polarity, "< >" for trigger condition, the oscilloscope triggers when the positive pulse width of the input signal is greater than the specified lower limit of pulse width and smaller than the specified upper limit of pulse width.
- When you select "Negative" for polarity, ">" for trigger condition, the oscilloscope triggers when the negative pulse width of the input signal is greater than the specified pulse width.
- When you select "Negative" for polarity, "<" for trigger condition, the oscilloscope triggers when the negative pulse width of the input signal is smaller than the specified pulse width.
- When you select "Negative" for polarity, "< >" for trigger condition, the oscilloscope triggers when the negative pulse width of the input signal is greater than the specified lower limit of pulse width and smaller than the specified upper limit of pulse width.

### Pulse Width Setting

- In the **When** menu, when ">" or "<" is selected, click or tap the input field of **Lower** or **Upper** to set the lower limit value or the upper limit value with the pop-up numeric keypad. You can also use the specified multifunction knob to set the value. The pulse width available is from 1 ns to 10 s.

- In the **When** menu, when "< >" is selected, click or tap the input field of **Upper** and **Lower** respectively to set the lower limit value and the upper limit value with the pop-up numeric keypad. You can also use the specified multifunction knob to set the values. The lower limit of the pulse width must be smaller than the upper limit.

### 8.7.3 Slope Trigger

In Slope trigger, the oscilloscope triggers on the positive or negative slope of the specified time. This trigger type is applicable to ramp and triangle waveforms.

In this oscilloscope, positive slope time is defined as the time difference between the two crossing points of trigger level line A and B with the rising edge; negative slope time is defined as the time difference between the two crossing points of trigger level line A and B with the falling edge. See the figure below.

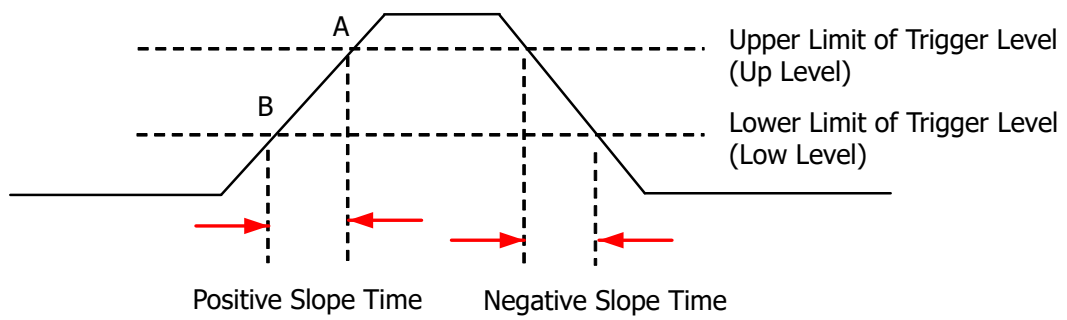
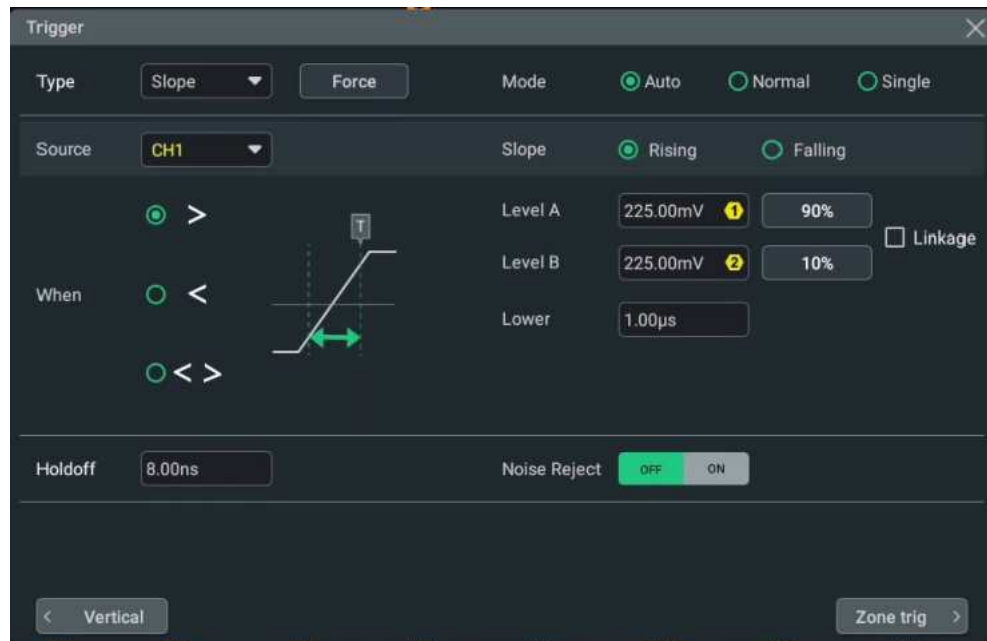

**Figure 8.6 Positive Slope Time/Negative Slope Time**

In this oscilloscope, positive slope time is defined as the time difference between the two crossing points of trigger level line A and B with the rising edge; negative slope time is defined as the time difference between the two crossing points of trigger level line A and B with the falling edge. See the figure below.

#### Trigger Type

Click or tap the drop-down button of **Type** to select "Slope". Then set the parameters for Slope trigger.



**Figure 8.7 Slope Trigger Setting Menu**

After a trigger type is selected, the current trigger setting information (including trigger type, trigger source, and trigger level) is displayed in the trigger information label at the top of the screen, as shown in the figure below. The information will change based on the trigger settings.



### Source Selection

Click or tap the drop-down button of **Source** to select the analog channel as the specified source. For the available channels of the specified model, refer to descriptions in *Trigger Source*. The selected trigger source is indicated in the trigger information label at the top of the screen.

Only when you select the channel (that has been input with signals) as the trigger source, can you obtain a stable trigger.

### Edge Type

Select the input signal edge (in the **Slope** item) on which the oscilloscope triggers.

- Rising: triggers on the rising edge of the input signal.
- Falling: triggers on the falling edge of the input signal.

### Trigger Condition

Sets the trigger condition in the **When** item.

- When you select "Rising" for the edge type, ">" for trigger condition, the oscilloscope triggers when the positive slope time of the input signal is greater than the specified time.
- When you select "Rising" for the edge type, "<" for trigger condition, the oscilloscope triggers when the positive slope time of the input signal is smaller than the specified time.
- When you select "Rising" for the edge type, "< >" for trigger condition, the oscilloscope triggers when the positive slope time of the input signal is greater than the specified lower limit time and smaller than the specified upper limit time.
- When you select "Falling" for the edge type, ">" for trigger condition, the oscilloscope triggers when the negative slope time of the input signal is greater than the specified time.
- When you select "Falling" for the edge type, "<" for trigger condition, the oscilloscope triggers when the negative slope time of the input signal is smaller than the specified time.
- When you select "Falling" for the edge type, "< >" for trigger condition, the oscilloscope triggers when the negative slope time of the input signal is greater than the specified lower limit time and smaller than the specified upper limit time.

### Slope Time Setting

- In the **When** item, when ">" or "<" is set to trigger conditions, click or tap the input field of **Lower** or **Upper** to set the lower limit value or the upper limit value with the pop-up numeric keypad. You can also use the corresponding knob to set the value. The slope time available is from 1 ns to 10 s.
- In the **When** item, when "< >" is set to trigger conditions, click or tap the input field of **Upper** and **Lower** respectively to set the upper limit value and the lower limit value with the pop-up numeric keypad. You can also use the corresponding knob to set the values. The lower slope time limit must be smaller than the upper slope time limit.

### Level Selection and Setting

After the trigger condition setting is completed, you need to adjust the trigger level to correctly trigger the signal and obtain a stable waveform.

Click or tap the **Level A/Level B** input field to set the level A/level B with the pop-up numeric keypad. You can also use the trigger level knob or use the specified multifunction knob to adjust level A/level B. Check the checkbox of **Linkage** to link Level A and Level B. The Level A and Level B will be adjusted synchronously. The upper limit and lower limit values change at the same time. The difference between upper and lower limit remains unchanged. For details, refer to descriptions in *Trigger*

**Level.** The current trigger level is displayed in the trigger information label at the top of the screen.



### TIP

Press down the trigger level knob and rotate it to adjust Level A, Level B, and Level AB (when linkage is enabled) in sequence.

## 8.7.4 Video Trigger

The video signal can include image information and timing information, which adopts different standards and formats. This series can trigger on the standard video signal field or line of NTSC (National Television Standards Committee), PAL (Phase Alternating Line), or SECAM (Sequential Couleur A Memoire).

### Trigger Type

Click or tap the drop-down button of **Type** to select "Video".

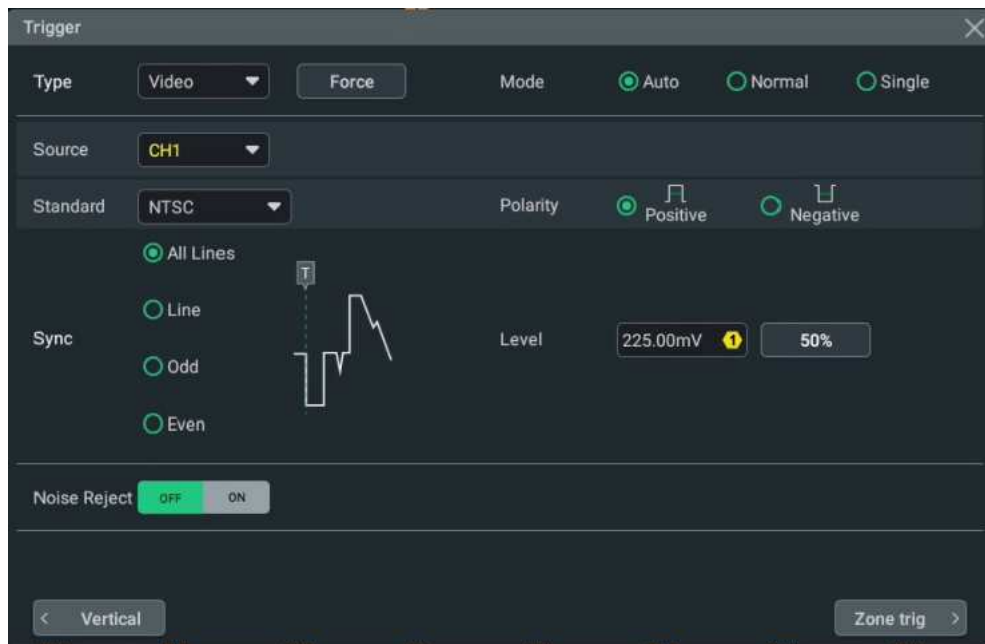

**Figure 8.8 Video Trigger Setting Menu**

After a trigger type is selected, the current trigger setting information (including trigger type, trigger source, and trigger level) is displayed in the trigger information label at the top of the screen, as shown in the figure below. The information will change based on the trigger settings.

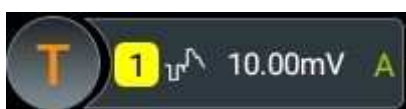



### Source Selection

Click or tap the drop-down button of **Source** to select the analog or digital channel as the specified source. For the available channels of the specified model, refer to descriptions in *Trigger Source*. The selected trigger source is indicated in the trigger information label at the top of the screen.

Only when you select the channel (that has been input with signals) as the trigger source, can you obtain a stable trigger.

### Video Polarity

In the **Polarity** item, select the desired polarity: positive polarity () or negative polarity ()

### Video Standard

Click or tap the drop-down button of **Standard** to select the desired video standard.

**Table 8.1 Video Standard**

| Video Standard | Frame Frequency (Frame) | Scan Type        | TV Scan Line |
|----------------|-------------------------|------------------|--------------|
| NTSC           | 30                      | Interlaced Scan  | 525          |
| PAL/SECAM      | 25                      | Interlaced Scan  | 625          |
| 480p/60Hz      | 60                      | Progressive Scan | 525          |
| 576p/50Hz      | 50                      | Progressive Scan | 625          |
| 720p/60Hz      | 60                      | Progressive Scan | 750          |
| 720p/50Hz      | 50                      | Progressive Scan | 750          |
| 720p/30Hz      | 30                      | Progressive Scan | 750          |
| 720p/25Hz      | 25                      | Progressive Scan | 750          |
| 720p/24Hz      | 24                      | Progressive Scan | 750          |
| 1080p/60Hz     | 60                      | Progressive Scan | 1125         |
| 1080p/50Hz     | 50                      | Progressive Scan | 1125         |
| 1080p/30Hz     | 30                      | Progressive Scan | 1125         |
| 1080p/25Hz     | 25                      | Progressive Scan | 1125         |
| 1080p/24Hz     | 24                      | Progressive Scan | 1125         |
| 1080i/60Hz     | 60                      | Interlaced Scan  | 1125         |
| 1080i/50Hz     | 50                      | Interlaced Scan  | 1125         |

### Sync

In the **Sync** item, select the desired sync type.

- All Lines: triggers on the first line found.
- Line: triggers on the specified line.

When this sync type is selected, you can specify a line number. Click or tap the input field of **Line** to set the line number by using the pop-up numeric keypad. You can also use the corresponding multifunction knob to set the value. The range of the line number is related to the currently selected video standards. The range is from 1 to 525 (NTSC), 1 to 625 (PAL/SECAM), 1 to 525 (480p), 1 to 625 (576p), 1 to 750 (720p), or 1 to 1125 (1080p/1080i).

- Odd: triggers on the rising edge of the first ramp pulse in the odd field. It is only available when the video standard is set to "NTSC" or "PAL/SECAM".
- Even: triggers on the rising edge of the first ramp pulse in the even field. It is only available when the video standard is set to "NTSC" or "PAL/SECAM".



#### TIP

- To better observe the waveform details in the video signal, you can set a larger memory depth first.
- As RIGOL's digital oscilloscope provides the intensity graded color display function, the frequency in different parts of the signal can be indicated in different brightness levels. In this way, the experienced users can quickly judge the signal quality and discover abnormalities during the debugging process.

## 8.7.5 Pattern Trigger

The pattern trigger identifies a trigger condition by looking for a specified pattern. This pattern is a logical "AND" combination of channels. Each channel can be set to H (high), L (low), or X (don't care). A rising or falling edge (you can only specify a single edge) can be specified for one channel included in the pattern. When an edge is specified, the oscilloscope will trigger at the edge specified if the pattern set for the other channels are true (namely the actual pattern of the channel is the same as the preset pattern). If no edge is specified, the oscilloscope will trigger on the last edge that makes the pattern true. If all the channels in the pattern are set to "X", the oscilloscope will not trigger.

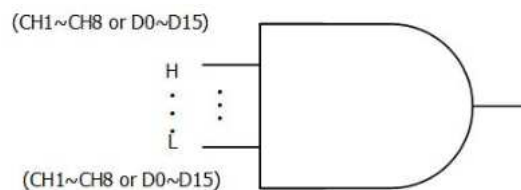

**Figure 8.9 Pattern Trigger**

#### Trigger Type

Click or tap the drop-down button of **Type** to select "Pattern".

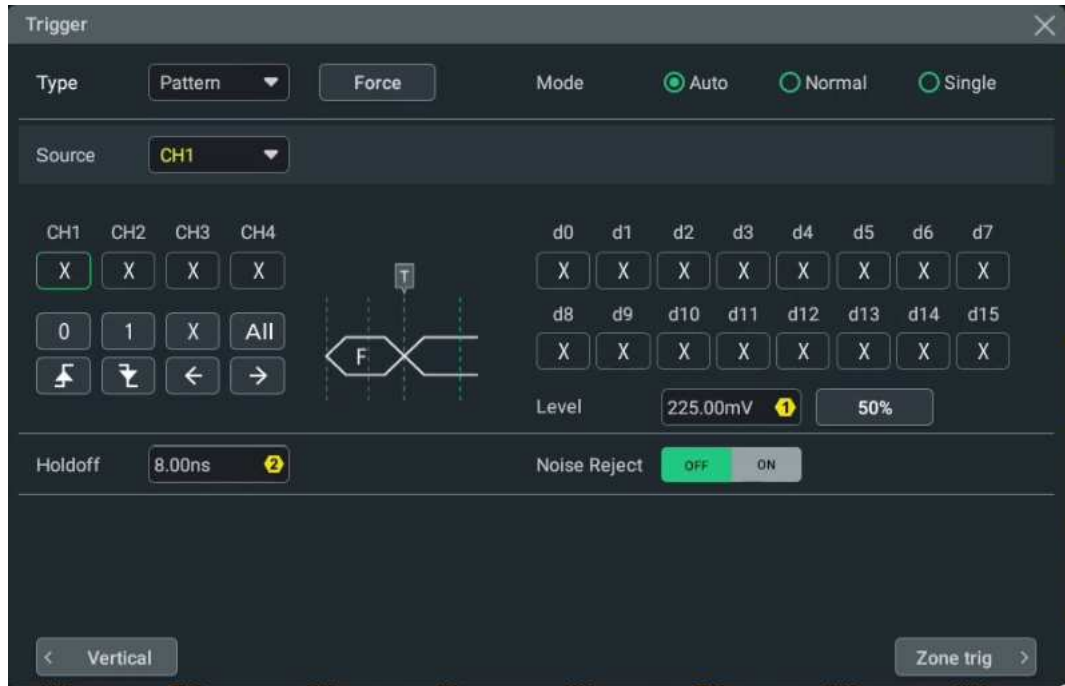

Figure 8.10 Pattern Trigger Setting Menu of MHO Series 4-CH Model



Figure 8.11 Pattern Trigger Setting Menu of DHO Series 8-CH Model

After a trigger type is selected, the current trigger setting information (including the trigger type, source, and level) is displayed in the trigger information label at the top of the screen, as shown in the figure below. The information will change based on the trigger settings.



### Select the Source



Click or tap the drop-down button of **Source** to select the analog channel or the digital channel as the trigger source. For available channels, refer to descriptions in

**Trigger Source.** The selected trigger source is indicated in the trigger information label at the top of the screen.

Only when you select the channel (that has been input with signals) as the trigger source, can you obtain a stable trigger.

### Pattern Setting

The following five patterns are available:

- 1: sets the pattern of the channel selected to "1", i.e. the voltage level is higher than the trigger level of the channel.
- 0: sets the pattern of the channel selected to "0", i.e. the voltage level is lower than the trigger level of the channel.
- X: sets the pattern of the channel selected to "X", i.e. this channel is not used as a part of the pattern. When all channels in the pattern are set to "X", the oscilloscope will not trigger.
- : sets the pattern to the rising edge of the channel selected.
- : sets the pattern to the falling edge of the channel selected.

The Left/Right arrow key indicates moving left/right to switch the channel pattern. "All" indicates all bits. Select a pattern for a channel and then click or tap **All**. The patterns of all the other channels will be set to the currently selected pattern. The pattern setting is shown in the figure below:



Only one edge (rising or falling edge) can be specified in the pattern. If one edge item is currently defined and then another edge item is defined in another channel in the pattern, then a prompt message "Invalid input" is displayed.

## 8.7.6 Duration Trigger

In duration trigger, the oscilloscope identifies a trigger condition by searching for the duration of a specified pattern. This pattern is a logical "AND" combination of the channels. Each channel can be set to 1 (high), 0 (low), or X (don't care). The

instrument triggers when the duration ( $\Delta T$ ) of this pattern meets the preset time, as shown in the figure below.

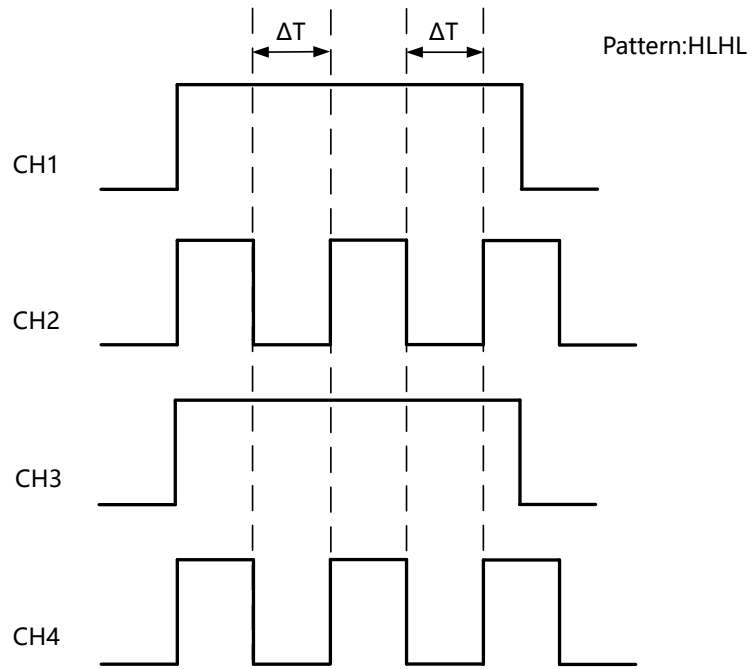

Figure 8.12 Duration Trigger

### Trigger Type

Click or tap the drop-down button of **Type** to select "Duration".

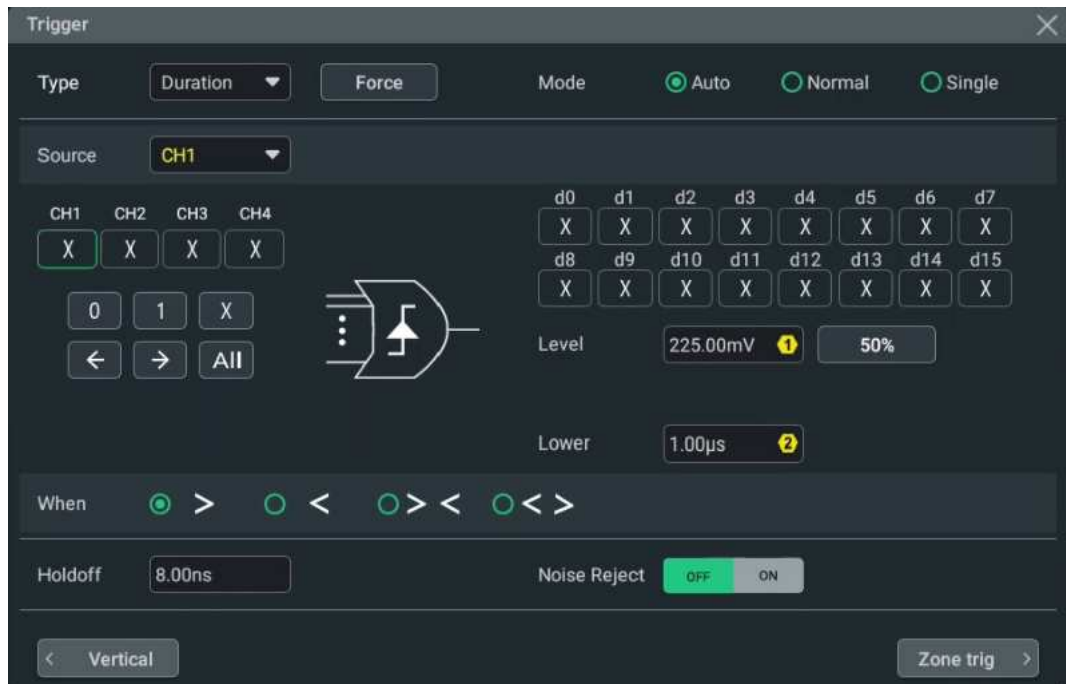
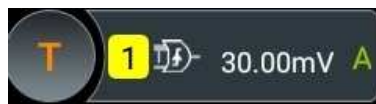

Figure 8.13 Duration Trigger Setting Menu of MHO Series 4-CH Model



**Figure 8.14 Duration Trigger Setting Menu of DHO Series 8-CH Model**

After a trigger type is selected, the current trigger setting information (including the trigger type, source, and level) is displayed in the trigger information label at the top of the screen, as shown in the figure below. The information will change based on the trigger settings.



### Select the Source

Click or tap the drop-down button of **Source** to select the analog channel or the digital channel as the trigger source. For available channels, refer to descriptions in *Trigger Source*. The selected trigger source is indicated in the trigger information label at the top of the screen.

Only when you select the channel (that has been input with signals) as the trigger source, can you obtain a stable trigger.

### Pattern Setting

The following three patterns are available:

- 1: sets the pattern of the channel selected to "1", i.e. the voltage level is higher than the trigger level of the channel.
- 0: sets the pattern of the channel selected to "0", i.e. the voltage level is lower than the trigger level of the channel.
- X: sets the pattern of the channel selected to "X", i.e. this channel is not used as a part of the pattern. When all channels in the pattern are set to "X", the oscilloscope will not trigger.

The Left/Right arrow key indicates moving left/right to switch the channel pattern.

"All" indicates all bits. Select a pattern for a channel, then click or tap **All**. The patterns of all the other channels will be set to the currently selected pattern.

## Trigger Condition

Set the trigger condition in the **When** item.

- **>**: triggers when the duration of the pattern is greater than the preset time. Click or tap the input field of **Lower** to set the lower limit of the duration of the pattern with the pop-up numeric keypad. You can also use the corresponding multifunction knob to set the value. The available range is from 1 ns to 10 s.
- **<**: triggers when the duration of the pattern is smaller than the preset time. Click or tap the input field of **Upper** to set the upper limit of the duration of the pattern. You can also use the corresponding multifunction knob to set the value. The available range is from 1 ns to 10 s.
- **< >**: triggers when the duration of the pattern is smaller than the upper limit of the preset time and greater than the lower limit of the preset time. Click or tap the input field of **Upper** to set the upper limit of the duration of the pattern, and the range is from 1.01 ns to 10 s. Click or tap the input field of **Lower** to set the lower limit of the duration of the pattern, and the range is from 1 ns to 9.9 s. You can also use the corresponding multifunction knob to set the upper/lower limit. The lower time limit must be smaller than the upper time limit.
- **> <**: triggers when the duration of the pattern is greater than the upper limit of the preset time or smaller than the lower limit of the preset time. Click or tap the input field of **Upper** to set the upper limit of the duration of the pattern, and the range is from 1.01 ns to 10 s. Click or tap the input field of **Lower** to set the lower limit of the duration of the pattern, and the range is from 1 ns to 9.9 s. You can also use the corresponding multifunction knob to set the upper and lower limit. The lower time limit must be smaller than the upper time limit.

### 8.7.7 Timeout Trigger

In Timeout trigger, the oscilloscope triggers when the time interval ( $\Delta T$ ) (the time from when the rising edge (or falling edge) of the input signal passes through the trigger level to the time from when the neighboring falling edge (or rising edge) passes through the trigger level) is greater than the preset timeout value, as shown in the figure below.

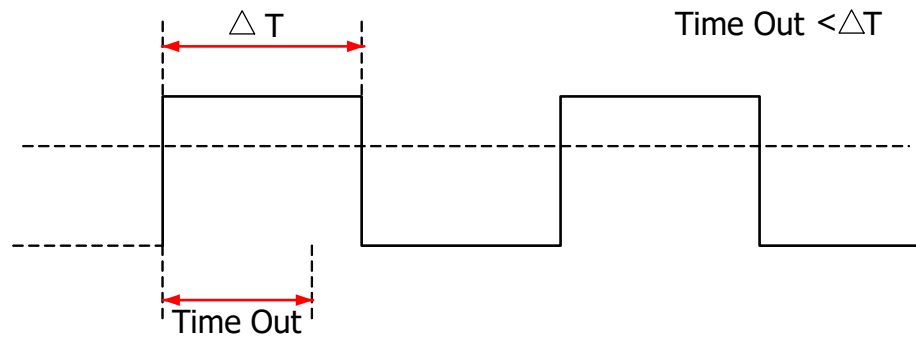

Figure 8.15 Timeout Trigger

### Trigger Type

Click or tap the **Type** drop-down button to select "Timeout".

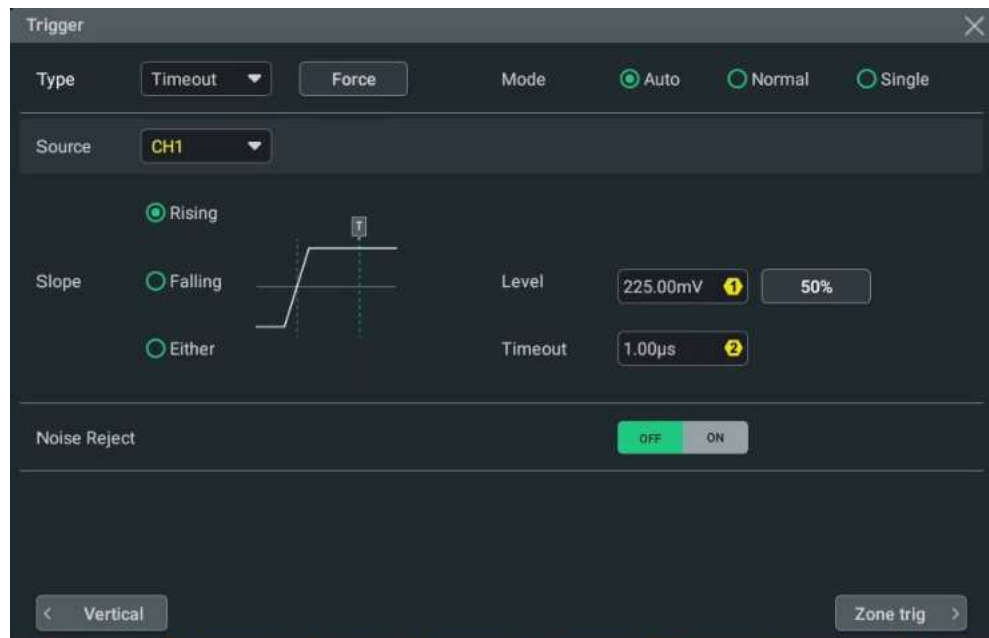
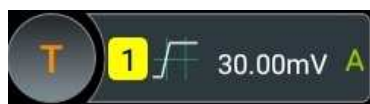

Figure 8.16 Timeout Trigger Menu

After a trigger type is selected, the current trigger setting information (including the trigger type, source, and level) is displayed in the trigger information label at the top of the screen, as shown in the figure below. The information will change based on the trigger settings.



### Select the Source

Click or tap the drop-down button of **Source** to select the analog channel or the digital channel as the trigger source. For available channels, refer to descriptions in

**Trigger Source.** The selected trigger source is indicated in the trigger information label at the top of the screen.

Only when you select the channel (that has been input with signals) as the trigger source, can you obtain a stable trigger.

### Edge Type

In **Slope** item, select the edge type from which the input signal passes through the trigger level.

- Rising: starts timing when the rising edge of the input signal passes through the trigger level.
- Falling: starts timing when the falling edge of the input signal passes through the trigger level.
- Either: starts timing when either edge of the input signal passes through the trigger level.

### Timeout Value

Timeout value represents the maximum time that the signal remains idle before the signal passes through the trigger level. Click or tap the input field of **Timeout**, and then use the pop-up numeric keypad to set the timeout value of Timeout trigger. You can also use the corresponding multifunction knob to set the value.

## 8.7.8 Runt Trigger

The Runt trigger is used to trigger pulses that pass through one trigger level but fail to pass through another trigger level, as shown in the figure below.

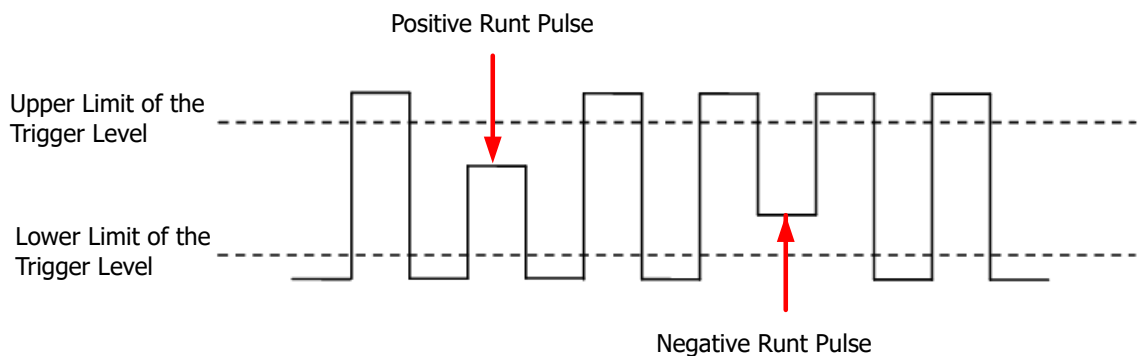

**Figure 8.17 Runt Trigger**

### Trigger Type

Click or tap the drop-down button of **Type** to select "Runt".

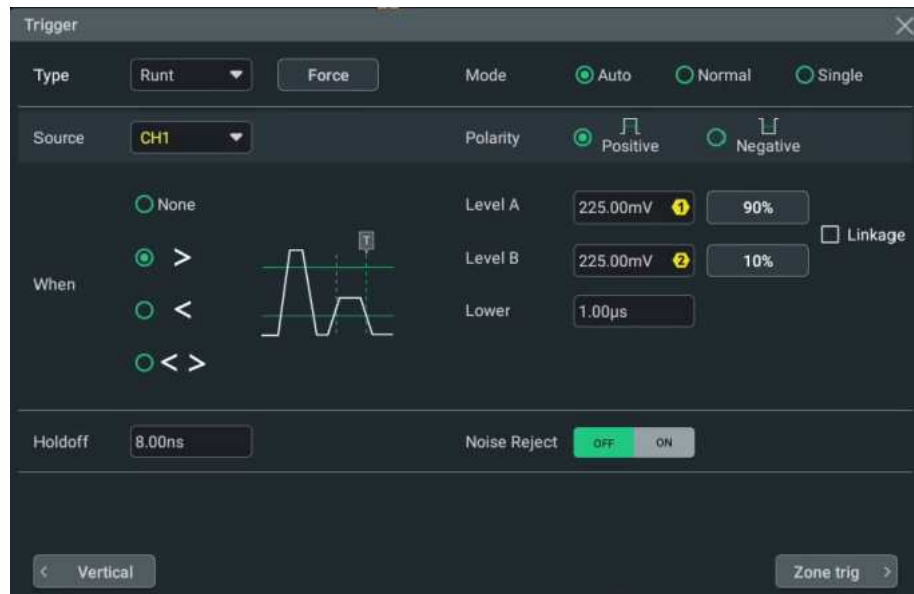

**Figure 8.18 Runt Trigger Setting Menu**

After a trigger type is selected, the current trigger setting information (including the trigger type, source, and level) is displayed in the trigger information label at the top of the screen, as shown in the figure below. The information will change based on the trigger settings.

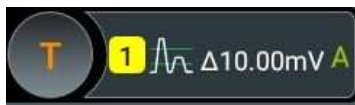



### Source Selection

Click or tap the drop-down button of **Source** to select the analog channel as the specified source. For the available channels of the specified model, refer to descriptions in *Trigger Source*. The selected trigger source is indicated in the trigger information label at the top of the screen.

Only when you select the channel (that has been input with signals) as the trigger source, can you obtain a stable trigger.

### Polarity

Select the pulse polarity of Runt trigger under the **Polarity** item.

- Positive : indicates that the instrument triggers on the positive runt pulse.
- Negative : triggers on the negative runt pulse.

### Trigger Condition

Set the Runt trigger condition in the **When** item.

- **None**: indicates not setting the trigger condition of Runt trigger.
- **>**: triggers when the runt pulse width is greater the Lower limit of pulse width. Click or tap the input field of **Lower** to set the minimum pulse width of Runt trigger with the pop-up numeric keypad. You can also use the corresponding multifunction knob to modify the value.
- **<**: triggers when the runt pulse width is smaller than the upper limit of pulse width. Click or tap the input field of **Upper** to set the maximum pulse width of Runt trigger with the pop-up numeric keypad. You can also use the corresponding multifunction knob to modify the value.
- **< >**: triggers when the runt pulse width is greater than the lower limit and smaller than the upper limit of pulse width. Click or tap the input field of **Upper** to set the maximum pulse width of Runt trigger with the pop-up numeric keypad. Click or tap the input field of **Lower** to set the minimum pulse width of Runt trigger with the pop-up numeric keypad. You can also use the corresponding multifunction knob to modify the maximum and minimum pulse width. The lower limit of the pulse width must be smaller than the upper limit.

### Level Selection and Setting

After the trigger condition setting is completed, you need to adjust the trigger level to correctly trigger the signal and obtain a stable waveform.

Click or tap the **Level A/Level B** input field to set the level A/level B with the pop-up numeric keypad. You can also use the trigger level knob or use the corresponding multifunction knob to adjust level A/level B. Check the checkbox of **Linkage** to link Level A and Level B. The Level A and Level B will be adjusted synchronously. The upper limit and lower limit values change at the same time. The difference between upper and lower limit remains unchanged. For details, refer to descriptions in *Trigger Level*. The current trigger level is displayed in the trigger information label at the top of the screen.



#### TIP

Press down the trigger level knob and rotate it to adjust Level A, Level B, and Level AB (when linkage is enabled) in sequence.

## 8.7.9 Window Trigger

Window trigger provides a high trigger level and a low trigger level. The instrument triggers when the input signal passes through the high trigger level or the low trigger level.

### Trigger Type

Selects the "Window" trigger type, and then set the parameters for Window trigger.

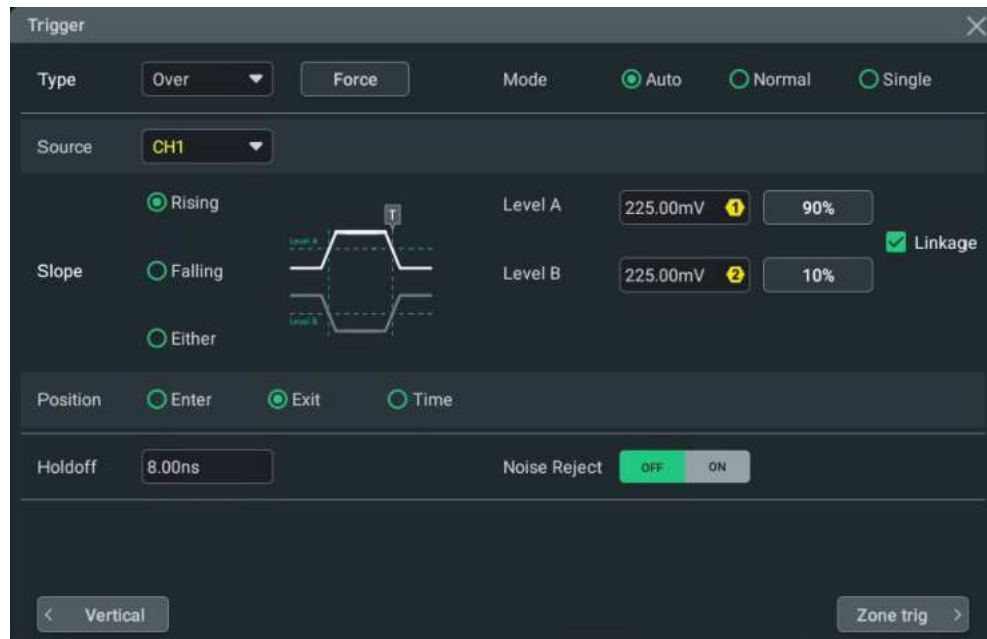

**Figure 8.19 Window Trigger Setting Menu**

After selecting the trigger type, and then the current trigger setting information (including trigger type, trigger source, and trigger level) is displayed in the trigger information label at the top of the screen, as shown in the figure below. The information will change based on the trigger settings.



### Source Selection

Click or tap the drop-down button of **Source** to select the desired analog channel from the drop-down list. For available channels, refer to descriptions in *Trigger Source*. The current trigger source is displayed in the trigger information label at the top of the screen.

Only when we select the channel (that has been input with signals) as the trigger source, can we obtain a stable trigger.

### Edge Type

Selects the desired input signal edge on which the oscilloscope triggers.

- Rising: triggers on the rising edge of the input signal when the voltage level is higher than the preset high trigger level.
- Falling: triggers on the falling edge of the input signal when the voltage level is lower than the preset low trigger level.

- **Either:** triggers on the rising or falling edge of the input signal when the voltage level meets the preset trigger level.

### Trigger Position

Sets the time point of trigger.

- **Enter:** triggers when the input signal enters the specified trigger level range.
- **Exit:** triggers when the input signal exits the specified trigger level range.
- **Time:** triggers when the accumulated hold time since the input signal entered the specified trigger level range is equal to the window time. After selecting this option, you can set the time. The available range is from 1 ns to 10 s.

### Set the Trigger Level

Sets the trigger level to trigger the signal properly and obtain a stable waveform.

- **Level A:** only adjusts the upper limit of the trigger level, and the lower limit of the trigger level remains unchanged.
- **Level B:** only adjusts the lower limit of the trigger level, and the upper limit of the trigger level remains unchanged.
- **Linkage:** When you check the checkbox of Linkage, the upper and lower trigger level can be adjusted synchronously. The trigger level deviation (the difference between the upper limit and lower limit) remains unchanged.

You can set "Level A" and "Level B" with the pop-up numeric keypad. You can also rotate the Trigger Level knob on the front panel or the specified multifunction knob indicated in the input field of **Level A** and **Level B** to set the value. For details, refer to descriptions in *Trigger Level*.

#### TIP

Press down the trigger level knob and rotate it to adjust Level A, Level B, and Level AB (when linkage is enabled) in sequence.



## 8.7.10 Delay Trigger

In Delay trigger, you need to set Source A and Source B. The oscilloscope triggers when the time difference ( $\Delta T$ ) between the specified edges (Edge A and Edge B) of Source A and Source B meets the preset time limit, as shown in the figure below. See the figure below.

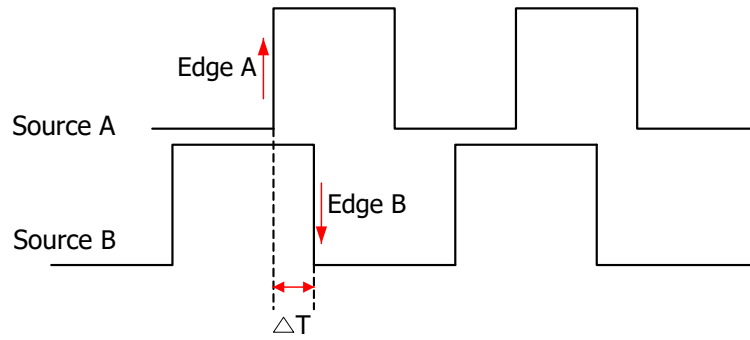

Figure 8.20 Delay Trigger

**Trigger Type**

Click or tap the drop-down button of **Type** to select "Delay".

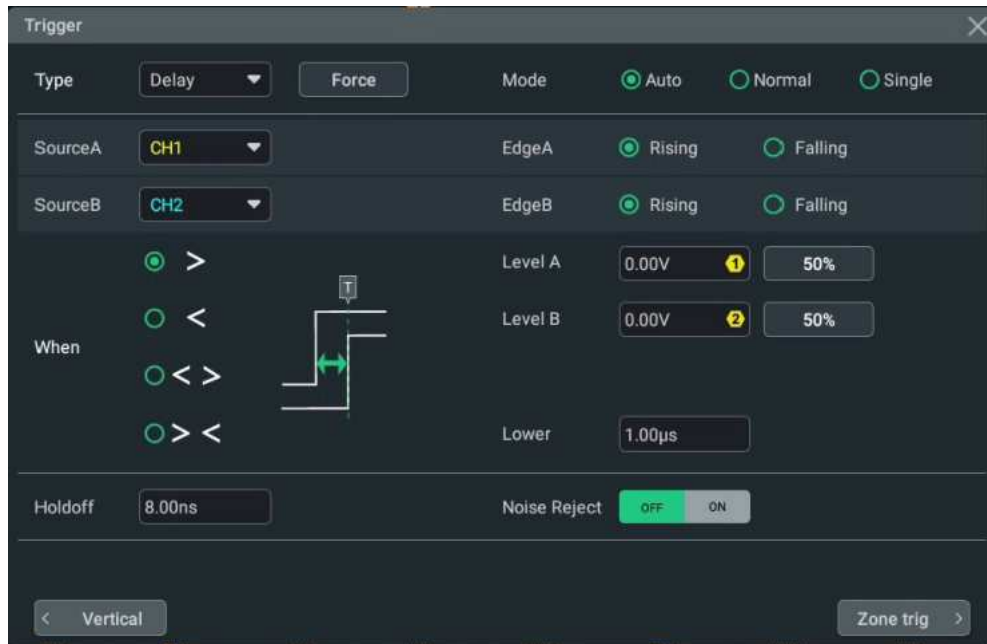
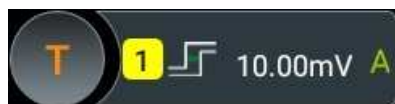

Figure 8.21 Delay Trigger Setting Menu

After a trigger type is selected, the current trigger setting information (including trigger type, trigger source, and trigger level) is displayed in the trigger information label at the top of the screen, as shown in the figure below. The information will change based on the trigger settings.



**Source Setting**

- **Source A**

Click or tap the drop-down button of **Source A** to select analog channel or digital channel as the trigger source of Source A. For details, refer to descriptions in *Trigger Source*. The selected trigger source is indicated in the trigger information label at the top of the screen.

Only when you select the channel that has signal inputs as the trigger source, can you obtain a stable trigger.

- **Edge A**

Select the trigger edge type ("Rising" or "Falling") of Source A in Delay trigger in the **Edge A** item.

- **Source B**

Click or tap the drop-down button of **Source B** to select analog channel or digital channel as the trigger source of Source B. For details, refer to descriptions in *Trigger Source*. The selected trigger source is indicated in the trigger information label at the top of the screen.

Only when you select the channel (that has been input with signals) as the trigger source, can you obtain a stable trigger.

- **Edge B**

Select the trigger edge type ("Rising" or "Falling") of Source B in Delay trigger in the **Edge B** item.

### Set the Trigger Condition

Set the time limit condition of Delay trigger in the **Slope**.

- **>**: triggers when the time difference ( $\Delta T$ ) between the specified edges of Source A and Source B is greater than the preset time lower limit. Click or tap the input field of **Lower** to set the delay time lower limit in Delay trigger with the pop-up numeric keypad. You can also use the specified multifunction knob to set the value.
- **<**: triggers when the time difference ( $\Delta T$ ) between the specified edges of Source A and Source B is smaller than the preset time upper limit. Click or tap the input field of **Upper** to set the delay time upper limit in Delay trigger with the pop-up numeric keypad. You can also use the specified multifunction knob to set the value.
- **< >**: triggers when the time difference ( $\Delta T$ ) between the specified edges of Source A and Source B is greater than the lower limit of the preset time and smaller than the upper limit of the preset time. Click or tap the input field of **Upper** to set the delay time upper limit in Delay trigger with the pop-up numeric keypad. Click or tap the input field of **Lower** to set the delay time lower limit in Delay trigger with the pop-up numeric keypad. You can also use the specified multifunction knob to set the upper and lower limit. The lower time limit must be smaller than the upper time limit.

- > <: triggers when the time difference ( $\Delta T$ ) between the specified edges of Source A and Source B is smaller than the lower limit of the preset time or greater than the upper limit of the preset time. Click or tap the input field of **Upper** to set the delay time upper limit in Delay trigger with the pop-up numeric keypad. Click or tap the input field of **Lower** to set the delay time lower limit in Delay trigger with the pop-up numeric keypad. You can also use the specified multifunction knob to set the upper and lower limit. The lower time limit must be smaller than the upper time limit.

### Level Selection and Setting

After the trigger condition setting is completed, you need to adjust the trigger level to correctly trigger the signal and obtain a stable waveform.

Click or tap the input field of **Level A/Level B** to set the level A/level B with the pop-up numeric keypad. You can also use the specified multifunction knob to adjust level A/level B or use the trigger level knob to adjust the level (the focus of the trigger level knob is the last modified level). For details, refer to descriptions in *Trigger Level*. The current trigger level is displayed in the trigger information label at the top of the screen.

## 8.7.11 Setup/Hold Trigger

In setup&hold trigger, you need to set the clock source and data source. The setup time starts when the data signal passes the trigger level and ends at the coming of the specified clock edge; the hold time starts at the coming of the specified clock edge and ends when the data signal crosses the trigger level again, as shown in the figure below. The oscilloscope triggers when the setup time or hold time is smaller than the preset time.

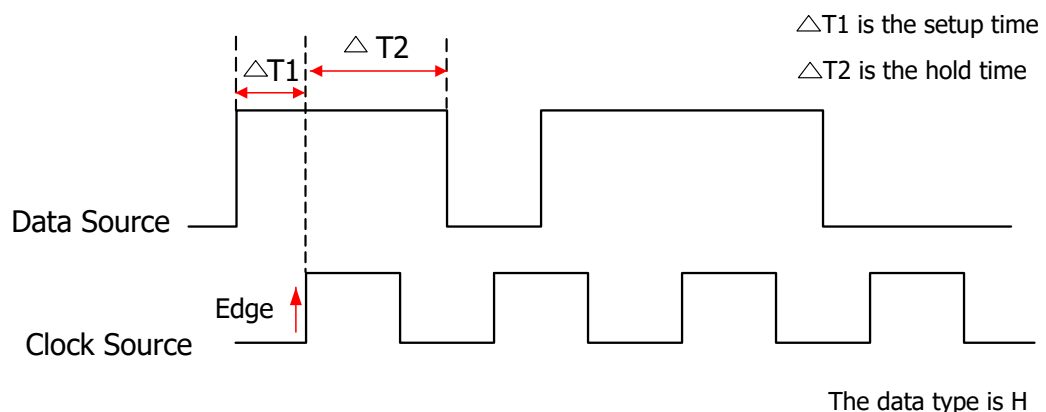
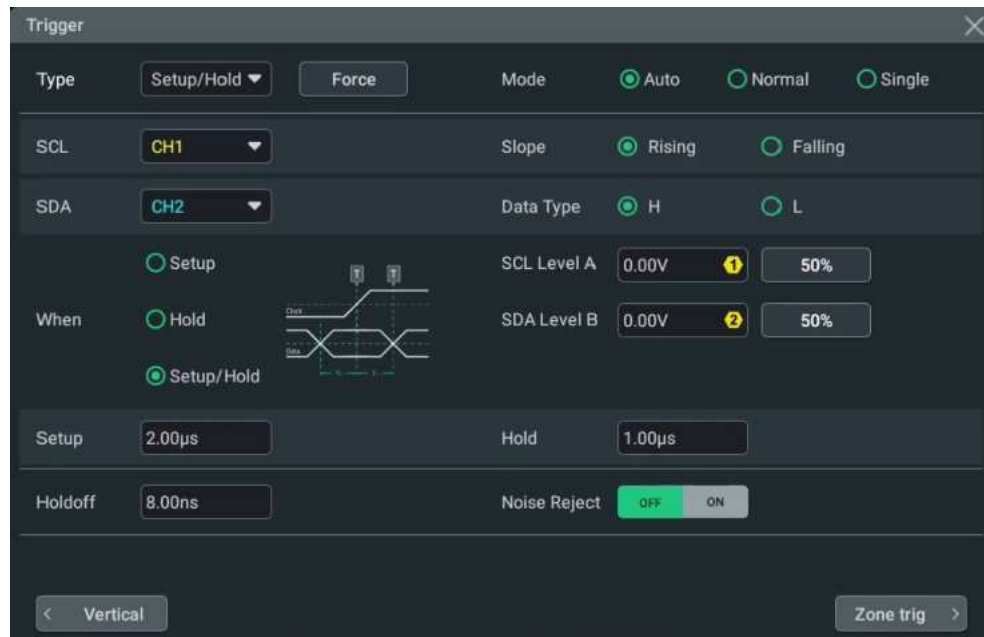

Figure 8.22 Setup/Hold Trigger

### Trigger Type

Click or tap the drop-down button of **Type** to select "Setup/Hold".



**Figure 8.23 Setup/Hold Trigger Setting Menu**

After a trigger type is selected, the current trigger setting information (including the trigger type, source, and level) is displayed in the trigger information label at the top of the screen, as shown in the figure below. The information will change based on the trigger settings.



### Clock Source

Click or tap the drop-down button of **SCL** to select specified analog channel or digital channel. For details, refer to descriptions in *Trigger Source*. The selected trigger source is indicated in the trigger information label at the top of the screen.

Only when you select the channel (that has been input with signals) as the trigger source, can you obtain a stable trigger.

### Data Source

Click or tap the drop-down button of **SDA** to select analog channel or digital channel. For details, refer to descriptions in *Trigger Source*. The selected trigger source is indicated in the trigger information label at the top of the screen.

Only when you select the channel that has signal inputs as the trigger source, can you obtain a stable trigger.

### Trigger Condition

Set the Setup/Hold trigger condition in the **When** item.

- **Setup:** the oscilloscope triggers when the setup time is smaller than the specified setup time. After selecting this type, click or tap the input field of **Setup** to set the setup time with the pop-up numeric keypad. You can also use the specified multifunction knob to set the value.
- **Hold:** the oscilloscope triggers when the hold time is smaller than the specified hold time. After selecting this type, click or tap the input field of **Hold** to set the hold time with the pop-up numeric keypad. You can also use the specified multifunction knob to set the value.
- **Setup/Hold:** the oscilloscope triggers when the setup time or hold time smaller than the specified time value. After selecting this type, click or tap the input field of **Setup** and **Hold** respectively to set the setup and hold time with the pop-up numeric keypad. You can also use the specified multifunction knob to set the values.

### Level Selection and Setting

After the trigger condition setting is completed, you need to adjust the trigger level to correctly trigger the signal and obtain a stable waveform.

Click or tap the input field of **SCL Level A** or **SDA Level B** to set SCL Level A and SDA Level B with the pop-up numeric keypad, respectively. You can also use the specified multifunction knob to adjust SCL Level A and SDA Level B or use the trigger level knob to adjust the level (the focus of the trigger level knob is the last modified level). For details, refer to descriptions in *Trigger Level*. The current trigger level is displayed in the trigger information label at the top of the screen.

## 8.7.12 Nth Edge Trigger

Triggers on the Nth edge that appears after the specified idle time. For example, in the waveform as shown in the figure below, the instrument should trigger on the second rising edge after the specified idle time (the time between two neighboring rising edges), and the idle time should be within the range between P and M ( $P < \text{Idle Time} < M$ ). Wherein, M is the time between the first rising edge and its previous rising edge; P is the maximum time between the rising edges that participate in counting.

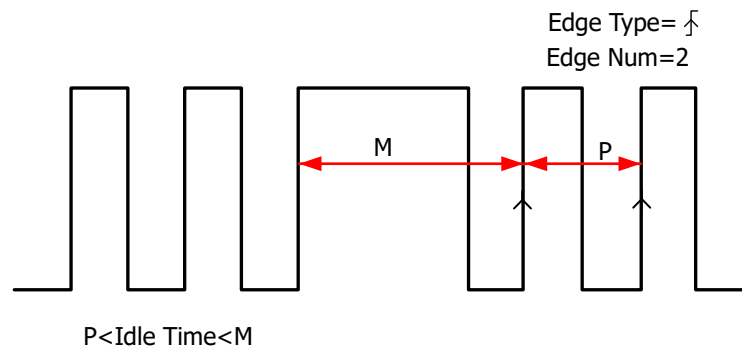

Figure 8.24 Nth Edge Trigger

### Trigger Type

Click or tap the drop-down button of **Type** to select "Nth Edge".

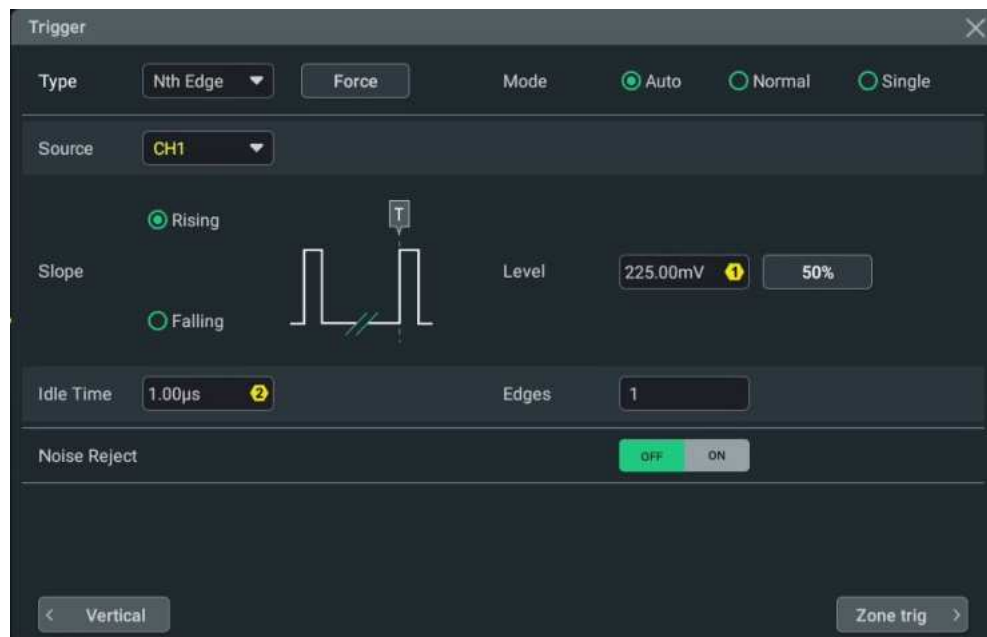
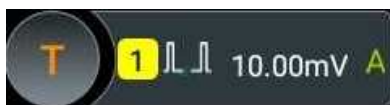

Figure 8.25 Nth Edge Trigger Setting Menu

After a trigger type is selected, the current trigger setting information (including trigger type, trigger source, and trigger level) is displayed in the trigger information label at the top of the screen, as shown in the figure below. The information will change based on the trigger settings.



### Select the Source

Click or tap the drop-down button of **Source** to select the analog channel or the digital channel as the trigger source. For available channels, refer to descriptions in *Trigger Source*. The selected trigger source is indicated in the trigger information label at the top of the screen.

Only when you select the channel (that has been input with signals) as the trigger source, can you obtain a stable trigger.

### Edge Type

Select the input signal edge (in the **Slope** item) on which the oscilloscope triggers.

- Rising: triggers on the rising edge of the input signal when the voltage level meets the specified trigger level.
- Falling: triggers on the falling edge of the input signal when the voltage level meets the specified trigger level.

### Idle Time

Click or tap the input field of **Idle Time**, and then use the pop-up numeric keypad to set the idle time before starting the edge counting in Nth edge trigger. You can also use the specified multifunction knob to set the value.

### Edge Count

Click or tap the input field of **Edges**, then use the pop-up numeric keypad to set the value of "N" in Nth edge trigger. You can also use the specified multifunction knob to set the value. The available range is from 1 to 65,535.

## 8.7.13 RS232 Trigger

RS232 bus is a serial communication mode used in data transmission between PCs or between a PC and a terminal. In RS232 serial protocol, a character is transmitted as a frame of data. The frame consists of 1 start bit, 5-8 data bits, 1 check bit, and 1-2 stop bits. Its format is as shown in the figure below. This series oscilloscope triggers when the start frame, error frame, check error, or the specified data of the RS232 signal is detected.

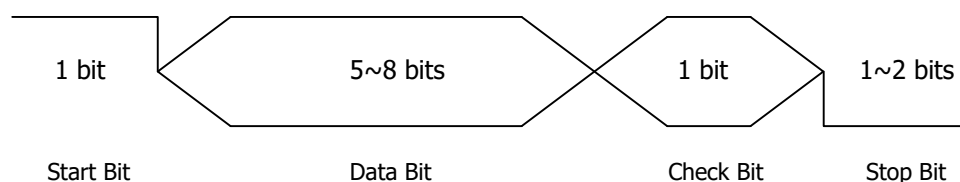

**Figure 8.26 Schematic Diagram of RS232 Protocol**

## Trigger Type

Click or tap the drop-down button of **Type** to select "RS232".

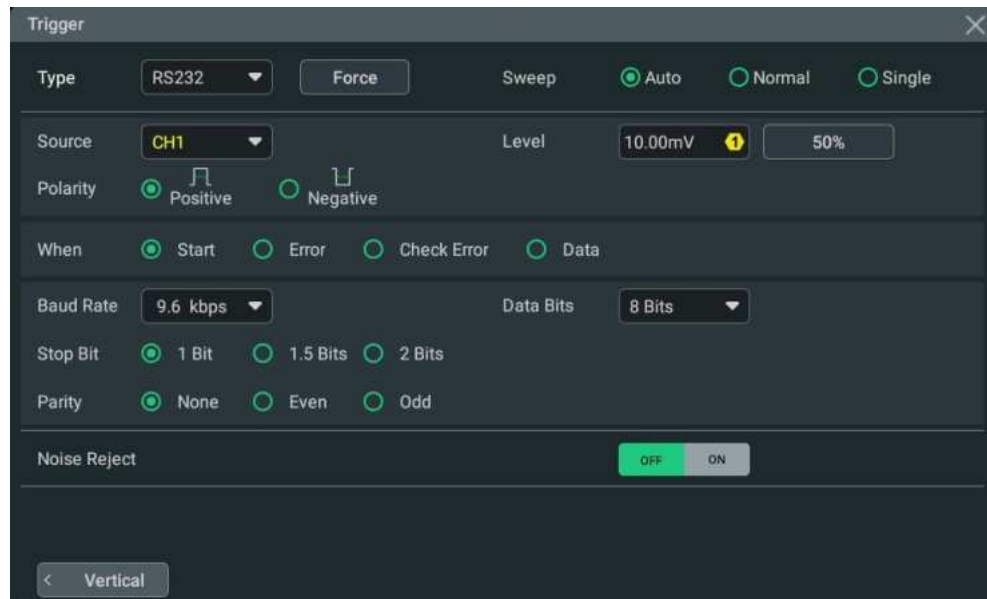

**Figure 8.27 RS232 Trigger Setting Menu**

After a trigger type is selected, the current trigger setting information (including the trigger type, source, and level) is displayed in the trigger information label at the top of the screen, as shown in the figure below. The information will change based on the trigger settings.

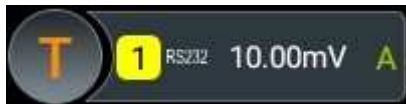

### Select the Source

Click or tap the drop-down button of **Source** to select the analog channel or the digital channel as the trigger source. For available channels, refer to descriptions in [Trigger Source](#). The selected trigger source is indicated in the trigger information label at the top of the screen.

Only when you select the channel (that has been input with signals) as the trigger source, can you obtain a stable trigger.

### Polarity

Select the polarity of data transmission in the **Polarity** item. It can be set to "Positive"



### Trigger Condition

Set the desired trigger condition in the **When** item.

- **Start:** triggers on the start frame position.
- **Error:** triggers when an error frame is detected.
- **Check Error:** triggers when a check error is detected.
- **Data:** triggers on the last bit of the preset data bits. Click or tap the input field of **Data**, and then use the pop-up numeric keypad to set the data of RS232 trigger. You can also use the specified multifunction knob to set the value.

### Baud Rate

You can select the baud rate of data transmission (i.e. specifies a clock frequency). Click or tap the drop-down button of **Baud Rate**, then select the preset baud rate. The available baud rates include 50 bps, 75 bps, 110 bps, 134 bps, 150 bps, 300 bps, and etc. You can also self-define the baud rate.

### Data Bits

Indicate the number of bits per frame. Click or tap the drop-down button of **Data Bits** to select the desired data bits. The available data bits include "5 Bits", "6 Bits", "7 Bits", and "8 Bits".

### Stop Bit

Indicates when to stop outputting data. Select the desired stop bit in the **Stop Bit** item. The available data bits include 1 Bit, 1.5 Bits, and 2 Bits.

### Parity

Used to check whether the data are properly transmitted. Select None, Even, or Odd in the **Parity** item.

- **None:** indicates that no check bit appears during the transmission.
- **Even:** indicates that the total number of "1" in the data bit and check bit is an even number. For example, when 0x55 (01010101) is sent, "0" should be added to the check bit.
- **Odd:** indicates that the total number of "1" in the data bit and check bit is an odd number. For example, when 0x55 (01010101) is sent, "1" should be added to the check bit.

## 8.7.14 I2C Trigger

I2C is a 2-wire serial bus used to connect the microcontroller and its peripheral device. It is a bus standard widely used in the microelectronic communication control field.

The I2C serial bus consists of SCL and SDA. Its transmission rate is determined by SCL, and its transmission data is determined by SDA, as shown in the figure below. The instrument triggers on the start condition, restart, stop, missing acknowledgment,

specific device address, or data value. Besides, it can also trigger on the specific device address and data values at the same time.

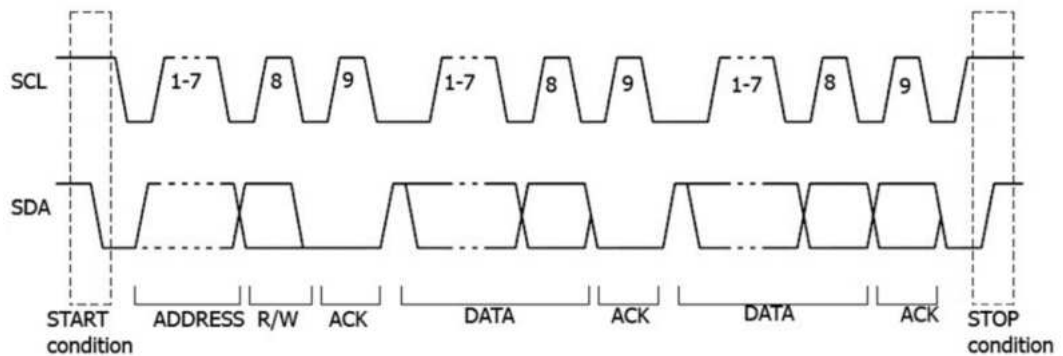

**Figure 8.28 Sequence Diagram of I2C Protocol**

### Trigger Type

Click or tap the drop-down button of **Type** to select "I2C".

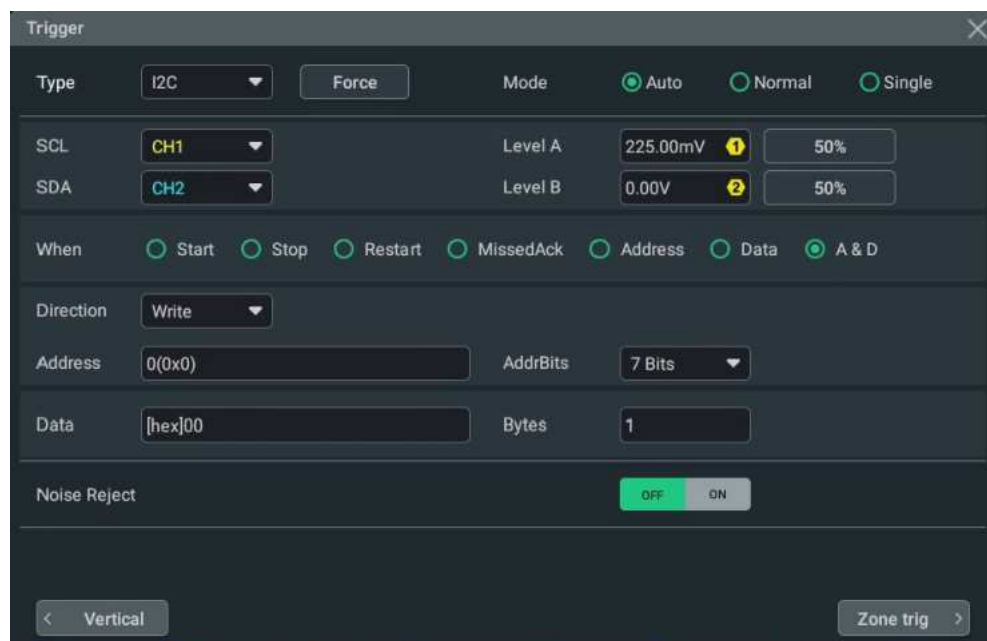

**Figure 8.29 I2C Trigger Setting Menu**

After a trigger type is selected, the current trigger setting information (including the trigger type, source, and level) is displayed in the trigger information label at the top of the screen, as shown in the figure below. The information will change based on the trigger settings.

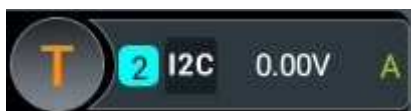

## Source Selection

Click or tap the drop-down button of **SCL** and **SDA** to select analog channel or digital channel as the source of SCL and SDA respectively. For details, refer to descriptions in *Trigger Source*. The current trigger source is indicated in the trigger information label at the top of the screen.

Only when you select the channel (that has been input with signals) as the trigger source, can you obtain a stable trigger.

## Trigger Condition

Set the desired trigger condition in the **When** item.

- **Start:** triggers when SDA data transitions from high level to low level while SCL is high level.
- **Stop:** triggers when SDA data transitions from low level to high level while SCL is high level.
- **Restart:** triggers when another start condition occurs before a stop condition.
- **MissedAck:** triggers when ACK is 1.
- **Address:** the trigger searches for the specified address value. When this event occurs, the oscilloscope will trigger on the read/write bit. After this trigger condition is selected:
  - Click or tap the drop-down button of **Direction** to select Write, Read, or R/W.  
This setting is not available when **AddrBits** is set to 8 Bits.
  - Click or tap the drop-down button of **AddrBits** to select the desired address bits. The available address bits are 7 Bits, 8 Bits, and 10 Bits.
  - Click or tap the input field of **Address**, and then use the pop-up numeric keypad to set the address of I2C trigger. You can also use the specified multifunction knob to set the value.
- **Data:** the trigger searches for the specified data value on the data line (SDA). When this event occurs, the oscilloscope will trigger on the clock line (SCL) transition edge of the last bit of data. After this trigger condition is selected, you can set the following parameters.
  - Click or tap the drop-down button of **AddrBits** to select the desired address bits. The available address bits are 7 Bits, 8 Bits, and 10 Bits.
  - Click or tap the input field of **Bytes**, and then use the pop-up numeric keypad to set the length of the data. You can also use the corresponding multifunction knob to set the value. Its range is from 1 to 5.
  - Click or tap the input field of **Data**, and then the "Format" interface is displayed. You can select "Bin" or "Hex" format to set the data format.

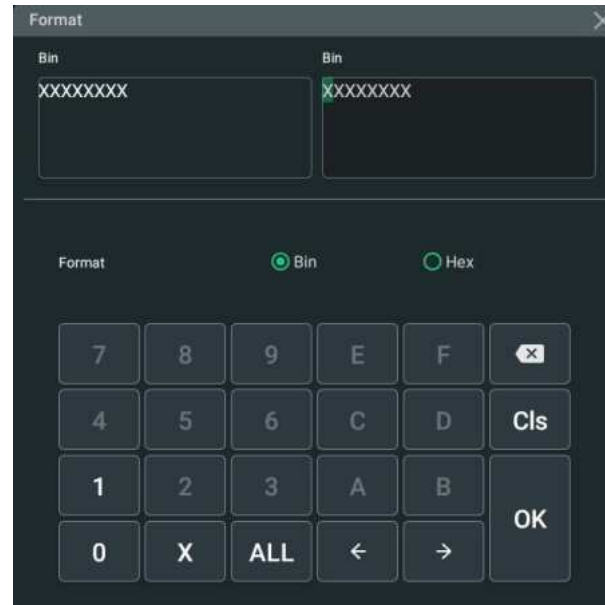

Figure 8.30 Binary Format Setting

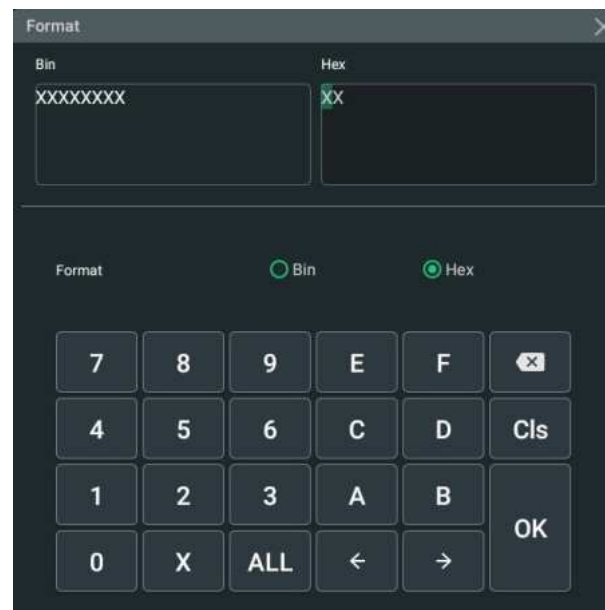

Figure 8.31 Hexadecimal Format Setting

- **A&D:** the oscilloscope searches for the specified address and data at the same time, then triggers when both the address and data meet the conditions. After this condition is selected, you need to set the sub Data-menu items such as **Direction**, **Bytes**, **AddrBits**, **Address**, and **Data**. For the setting methods, refer to descriptions in "Address" and "Data" conditions.

### Level Selection and Setting

After the trigger condition setting is completed, you need to adjust the trigger level to correctly trigger the signal and obtain a stable waveform.

- **Level A**

Click or tap the input field of **Level A** to input the level of SCL with the pop-up numeric keypad. You can also use the specified multifunction knob or the trigger level knob to adjust the level of SCL. For details, refer to descriptions in *Trigger Level*. The current trigger level is displayed in the trigger information label at the top of the screen.

- **Level B**

Click or tap the input field of **Level B** to input the level of SDA with the pop-up numeric keypad. You can also use the specified multifunction knob to set the value. For details, refer to descriptions in *Trigger Level*. The current trigger level is displayed in the trigger information label at the top of the screen.

## 8.7.15 SPI Trigger

In SPI trigger, after the CS or timeout condition is satisfied, the oscilloscope triggers when the specified data is found. When using SPI trigger, you need to specify the CLK clock sources and MISO data sources.

The figure below shows the sequential chart of SPI bus.

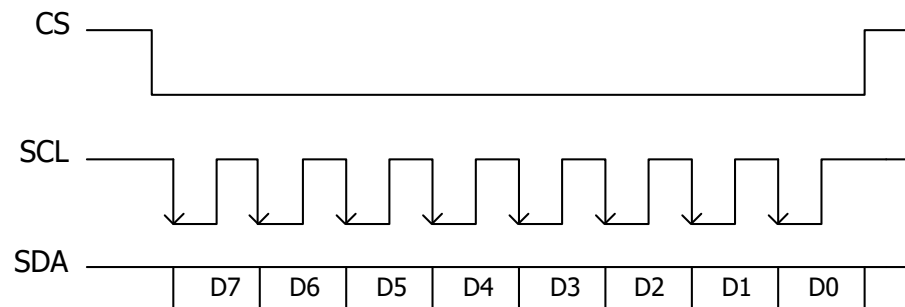

**Figure 8.32 Sequential Chart of SPI Bus**

### Trigger Type

Click or tap the drop-down button of **Type** to select "SPI".

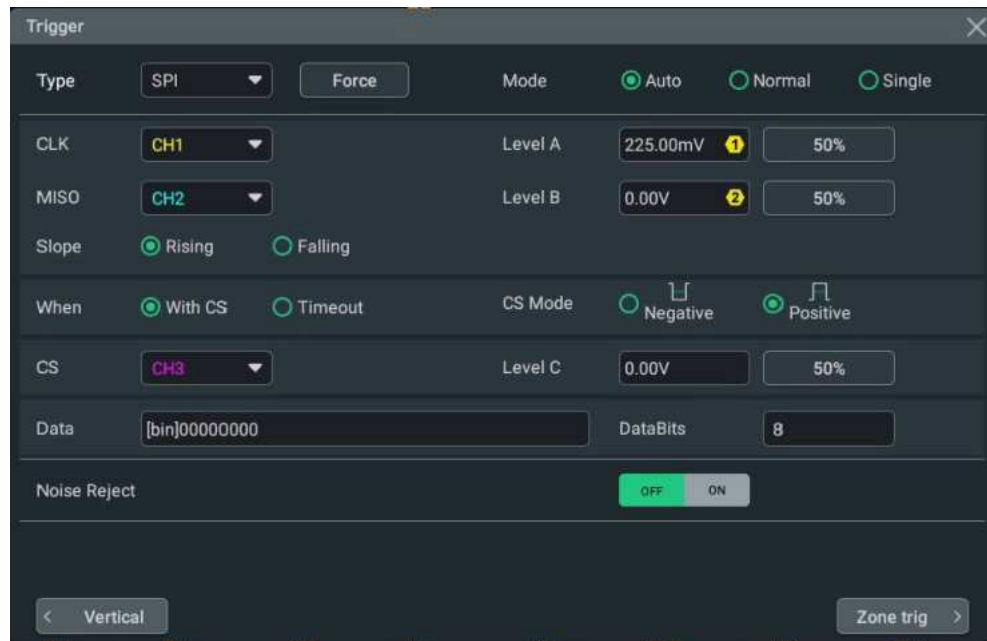

**Figure 8.33 SPI Trigger Setting Menu**

After a trigger type is selected, the current trigger setting information (including trigger type, trigger source, and trigger level) is displayed in the trigger information label at the top of the screen, as shown in the figure below. The information will change based on the trigger settings.

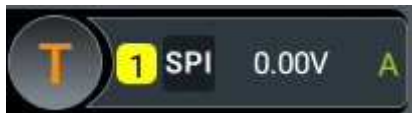

### Source Selection

Click or tap the drop-down button of **CLK** and **MISO** to select an analog channel or a digital channel as the source of CLK and MISO respectively. For available channels, refer to descriptions in *Trigger Source*. The current trigger source is indicated in the trigger information label at the top of the screen.

Only when you select the channel (that has been input with signals) as the trigger source, can you obtain a stable trigger.

### Edge Type

Select the desired clock edge type in **Slope**.

- Rising: samples the MISO data on the rising edge of the clock.
- Falling: samples the MISO data on the falling edge of the clock.

### Trigger Condition

Select the desired trigger condition in **When**.

- With CS: if the CS signal is valid, the oscilloscope will trigger when the data (SDA) satisfying the trigger conditions is found.
  - Click or tap the drop-down button of **CS** to select CH1-CH4 as the CS signal line.
  - After selecting this condition, you can click or tap "Positive" (high level is valid) or "Negative" (low level is valid) in **CS Mode**.
- Timeout: the oscilloscope starts to search for the data (MISO) on which to trigger after the clock signal (CLK) stays in the idle state for a specified period of time. After selecting this condition, you can click or tap the input field of **Timeout**, then use the pop-up numeric keypad to set the idle time. You can also use the specified multifunction knob to set the value. The range is from 8 ns to 10 s.

### Data

Click or tap the input field of **Data**, and then the Format interface is displayed. You can set the data bit that needs to be operated on. For details, refer to descriptions in *I2C Trigger*.

### Data Bits

Click or tap the input field of **DataBits**, and then use the pop-up numeric keypad to set the number of bits in the serial data string. You can also use the corresponding multifunction knob to set the value. The number of bits in the string can be set to any integer ranging from 4 to 32.

### Level Selection and Setting

After the trigger condition setting is completed, you need to adjust the trigger level to correctly trigger the signal and obtain a stable waveform.

- **Level A**

Click or tap the input field of **Level A** to input the level of CLK with the pop-up numeric keypad. You can also use the specified multifunction knob or the trigger level knob to adjust the level of CLK.

- **Level B**

Click or tap the input field of **Level B** to input the level of MISO with the pop-up numeric keypad. You can also use the specified multifunction knob to adjust the level of MISO.

- **Level C**

Click or tap the input field of **Level C** to input the level of CS with the pop-up numeric keypad. You can also use the specified multifunction knob to adjust the level of CS.

For details, refer to descriptions in *Trigger Level*. The current CLK trigger level A is displayed in the trigger information label at the top of the screen.

## 8.7.16 CAN Trigger (Option)

This series oscilloscope can trigger on the start of a frame, end of a frame, frame of the specified type (e.g. Remote, Overload, Data, etc.), or error frame of the specified type (e.g. Answer Error, Check Error, Format Error, etc.) of the CAN signal (option).

The data frame format of the CAN bus is as shown in the figure below.

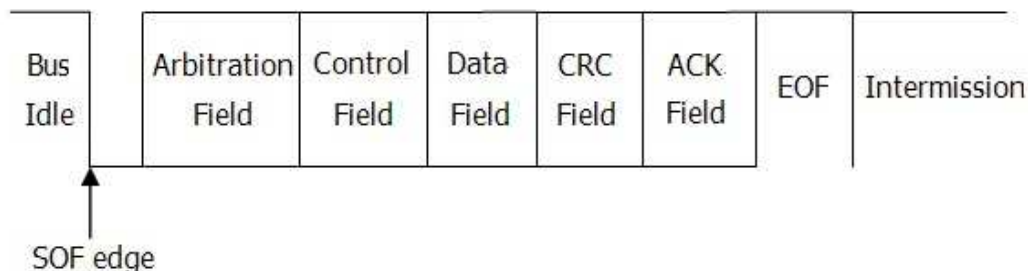

Figure 8.34 Data Frame Format of the CAN Bus

### Trigger Type

Click or tap the drop-down button of **Type** to select "CAN".

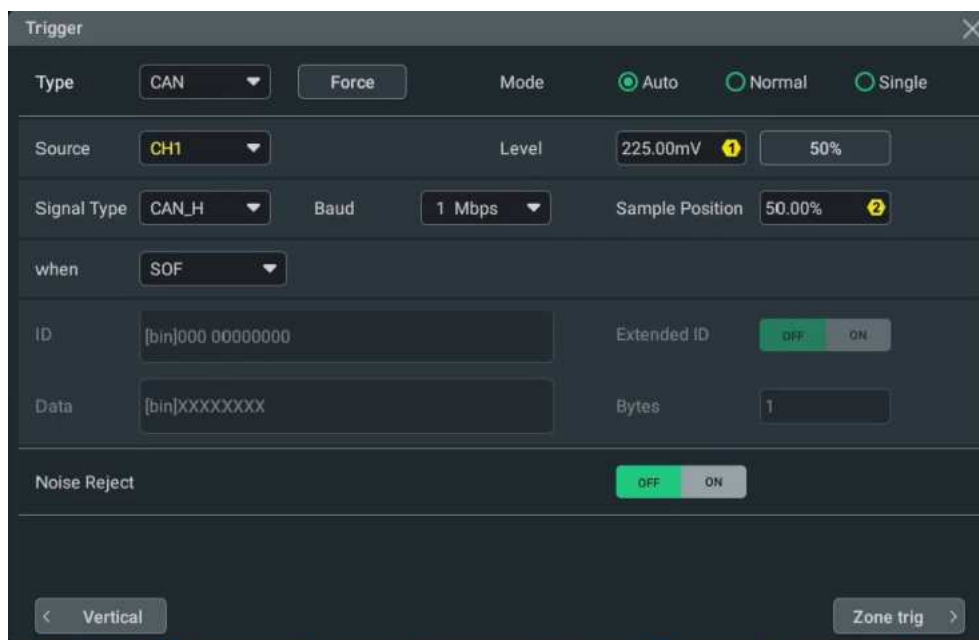
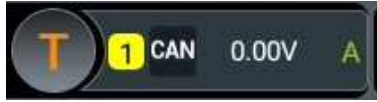

Figure 8.35 CAN Trigger Setting Menu

After a trigger type is selected, the current trigger setting information (including trigger type, trigger source, and trigger level) is displayed in the trigger information label at the top of the screen, as shown in the figure below. The information will change based on the trigger settings.



### Select the Source

Click or tap the drop-down button of **Source** to select the analog channel or the digital channel as the trigger source. For available channels, refer to descriptions in *Trigger Source*. The selected trigger source is indicated in the trigger information label at the top of the screen.

Only when you select the channel (that has been input with signals) as the trigger source, can you obtain a stable trigger.

### Signal Type

Click or tap the drop-down button of **Signal Type** to select the desired signal type.

- CAN\_H: indicates the actual CAN\_H bus signal.
- CAN\_L: indicates the actual CAN\_L bus signal.
- TX/RX: indicates the Transmit signal and Receive signal from the CAN bus transceiver.
- DIFF: indicates the CAN differential bus signals connected to an analog channel by using a differential probe. Connect the probe's positive lead to the CAN\_H bus signal and connect the negative lead to the CAN\_L bus signal.

### Baud Rate

Click or tap the drop-down button of **Baud** to select the preset baud rate. The available baud rates include 10 kbps, 20 kbps, 33.3 kbps, 50 kbps, 62.5 kbps, 83.3 kbps, and etc. You can also self-define the baud rate.

### Sample Position

Sample position is a point within a bit's time. The oscilloscope samples the bit level at this point. The sample position is represented by the proportion of "the time from the start of the bit to the sample position" to the "bit time", as shown in the figure below.

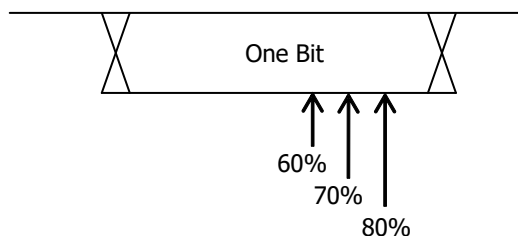

**Figure 8.36 Sample Position**

Click or tap the input field of **Sample Position** to set it by using the pop-up numeric keypad. You can also use the specified multifunction knob to set the value. The settable range is from 10% to 90%.

### Trigger Condition

Click or tap the drop-down button of **When** to select the desired trigger condition.

- SOF: triggers at the start of a frame.
- EOF: triggers at the end of a frame.
- Remote ID: triggers on the specified ID of Remote frame. When you select **Remote ID**, you need to set the following parameters.
  - Click or tap the ON/OFF tab for **Extended ID** to enable or disable the extended ID.
  - Click or tap the input field of **ID**, and then the "Format" interface is displayed. You can set the ID that needs to be operated on. For details, refer to descriptions in *I2C Trigger*.
- Overload: triggers on the overload frames.
- Frame ID: triggers on the data frames with the specified ID. After you select **Frame ID**, you can refer to the "Remote ID" mentioned above to set the **Extended ID** and **ID**.
- Frame Data: triggers on the data frames with the specified Data. When you select **Frame Data**, you need to set the following parameters.
  - Click or tap the input field of **Data**, and then the "Format" interface is displayed. You can set the data bit that needs to be operated on. For details, refer to descriptions in *I2C Trigger*.
  - Click or tap the input field of **Bytes**, and then use the pop-up numeric keypad to set the length of the data. You can also use the corresponding multifunction knob to set the value. Its range is from 1 to 8.
- Data & ID: triggers on the data frames with the specified ID and data. When you select **Data & ID**, you need to set the **ID**, **Extended ID**, **Data**, and **Bytes**.
- Frame Error: triggers on the error frame.
- Bit Fill: triggers on the error frame with the bit fill.
- Answer Error: triggers on the answer error frame.
- Check Error: triggers on the check error frame.
- Format Error: triggers on the format error frame.
- Random Error: triggers on the random error frame, such as the format error frame, answer error frame, etc.

### 8.7.17 FlexRay Trigger (Option)

This series can trigger on the specified frame, symbol, error, or position of the FlexRay bus. FlexRay is a type of differential serial bus configured with three consecutive segments (i.e. packet header, payload, and packet trailer). Its data transmission rate is up to 10 Mb/s. Each frame contains a static segment and a dynamic segment, with each frame ending with the bus idle time.

Its format is as shown in the figure below.

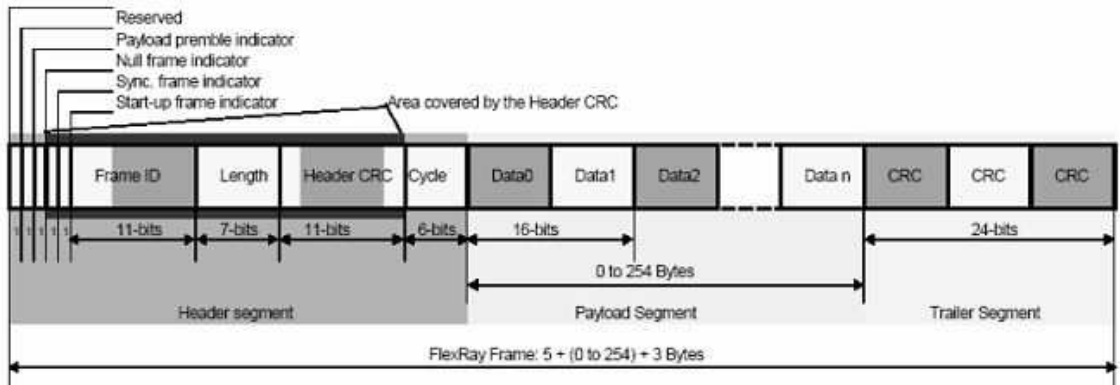

Figure 8.37 Frame Format of FlexRay Bus

#### Trigger Type

Click or tap the drop-down button of **Type** to select "FlexRay" from the drop-down list. Then set the parameters for FlexRay trigger.

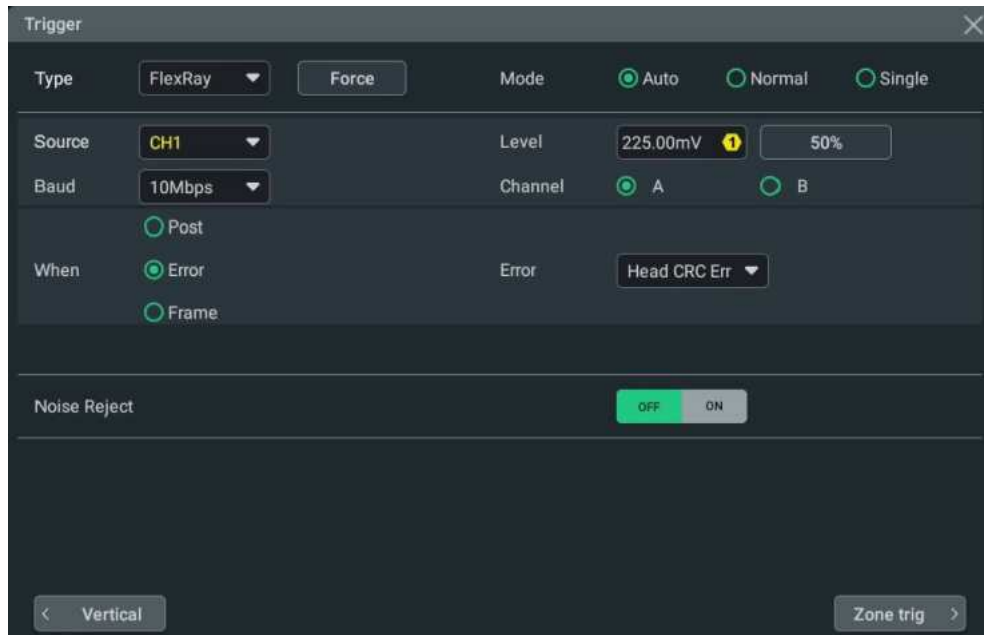
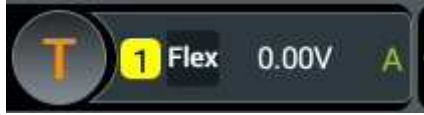

Figure 8.38 FlexRay Trigger Setting Menu

After selecting the trigger type, and then the current trigger setting information (including trigger type, trigger source, and trigger level) is displayed in the trigger information label at the top of the screen, as shown in the figure below. The information will change based on the trigger settings.



### Select the Source

Click or tap the drop-down button of **Source** to select the analog channel or the digital channel as the trigger source. For available channels, refer to descriptions in *Trigger Source*. The selected trigger source is indicated in the trigger information label at the top of the screen.

Only when you select the channel (that has been input with signals) as the trigger source, can you obtain a stable trigger.

### Baud Rate

You can set the baud rate of the signal. Click or tap the drop-down button **Baud** to select a FlexRay baud rate that matches the FlexRay bus signal. The available baud rates include 2.5 Mbps, 5 Mbps, and 10 Mbps.

### Trigger Condition

Select the trigger condition in the **When** menu.

- **Post:** triggers on the specified position of the FlexRay bus. Select **Post** as the trigger condition, and then click or tap its drop-down button to select "TSS End", "FSS\_BSS End", "FES End", or "DTS End" from the drop-down list.
- **Error:** triggers when an error occurs to the FlexRay bus. Click or tap the drop-down button of **Error** to select the error type. It includes Head CRC Err, Tail CRC Err, Decode Err, and Random Err.
- **Frame:** triggers on the frame of FlexRay bus.
  - Click or tap the drop-down button of **Frame** to select the frame type. The types of frames include null, Sync, Start, and All.
  - Select "Cyc Count" or "ID" under the **Define** menu.

When you select "Cyc Count", set the following parameters: Cyc Comp, Count Min, and Count Max. Click or tap the drop-down button of **Cyc Comp** to select the comparison conditions. The available choices include =, ≠, >, <, > <, and < >. When a certain condition is selected, click or tap the input field of **Count Min** or **Count Max**.

When you select "ID", set the following parameters: ID Comp, ID Min, and ID Max. Click or tap the drop-down button of **ID Comp** to select the comparison conditions. The available choices include =, ≠, >, <, > <, and <

>. When a certain condition is selected, click or tap the input field of **ID Max** or **ID Min**.

As the occurrence possibility of specified FlaxRay frame is very low, it is recommended that you set the oscilloscope to Normal trigger mode when the trigger condition is set to "Frame", so as to prevent the instrument from triggering automatically while waiting for the specified frame. The same goes for "Error" trigger condition.

## 8.7.18 LIN Trigger (Option)

This series can trigger on the sync field of LIN signal, and can also trigger on the specified identifier, data, or frame.

The data frame format of the LIN bus is as shown in the figure below.



Figure 8.39 Data Frame Format of the LIN Bus

### Trigger Type

Click or tap the drop-down button of **Type** to select "LIN" from the drop-down list. Then set the parameters for LIN trigger.

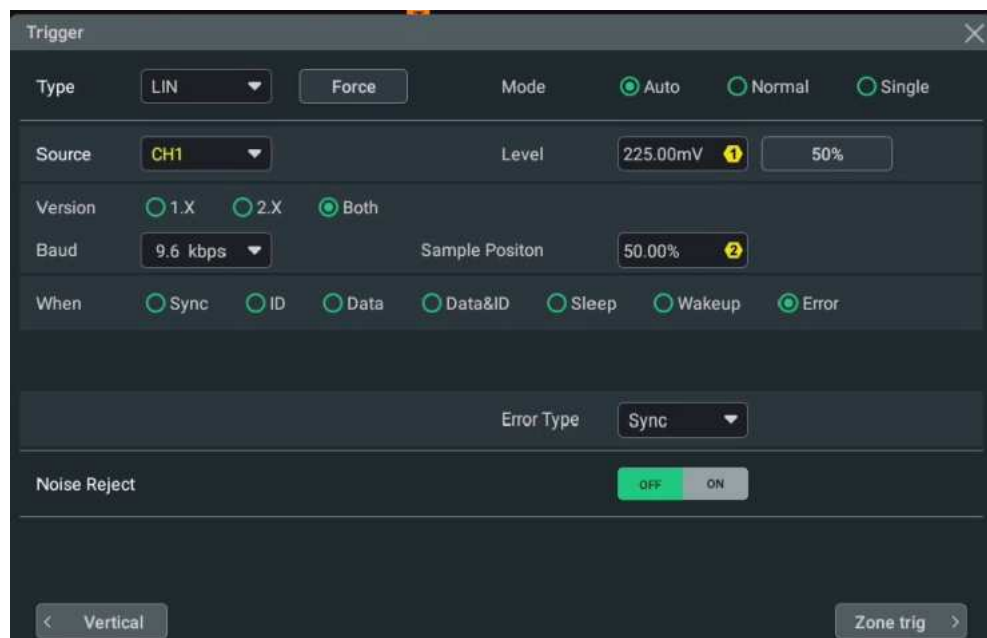

Figure 8.40 LIN Trigger Setting Menu

After a trigger type is selected, the current trigger setting information (including the trigger type, source, and level) is displayed in the trigger information label at the top

of the screen, as shown in the figure below. The information will change based on the trigger settings.



### Select the Source

Click or tap the drop-down button of **Source** to select the analog channel or the digital channel as the trigger source. For available channels, refer to descriptions in *Trigger Source*. The selected trigger source is indicated in the trigger information label at the top of the screen.

Only when you select the channel (that has been input with signals) as the trigger source, can you obtain a stable trigger.

### Protocol Version

In **Version**, select the protocol version that matches the signal under test. The available versions include 1.X, 2.X and Both.

### Baud Rate

Click or tap the drop-down button of **Baud** to select the preset baud rate. The available baud rates include 1.2 kbps, 2.4 kbps, 4.8 kbps, 9.6 kbps, 19.2 kbps, and etc. You can also self-define the baud rate.

### Sample Position

Sample position is a point within a bit's time. The oscilloscope samples the bit level at this point. The sample position is represented by the proportion of "the time from the start of the bit to the sample position" to the "bit time", as shown in the figure below.

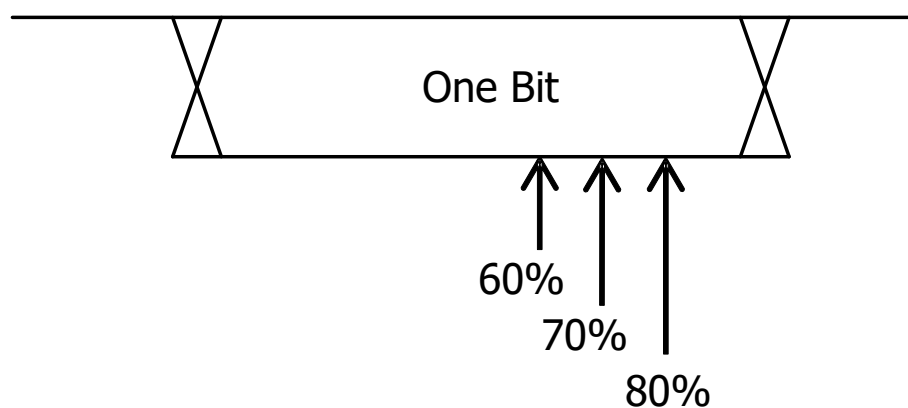

Figure 8.41 Sample Position

Click or tap the input field of **Sample Position** to set it by using the pop-up numeric keypad. You can also use the specified multifunction knob to set the value. The settable range is from 10% to 90%.

### Trigger Condition

Click or tap the drop-down button of **When** to select the desired trigger condition.

- **Sync:** triggers on the last bit of the sync field.
- **ID:** triggers when the frames with the specified ID are found.

Click or tap the input field of **ID**, and then use the pop-up numeric keypad to set ID. You can also use the corresponding multifunction knob to set the value.

- **Data:** triggers when the data that meet the preset conditions are found.
  - Click or tap the input field of **Data**, and then the "Format" interface is displayed. You can set the data bit that needs to be operated on. For details, refer to descriptions in *I2C Trigger*.
  - Click or tap the input field of **Bytes**, and then use the pop-up numeric keypad to set the length of the data. You can also use the corresponding multifunction knob to set the value. Its range is from 1 to 8.
- **Data&ID:** triggers when the frames with the specified ID and data that meet the preset conditions are both found.

When **Data&ID** is selected, you need to set the **Data**, **Bytes**, and **ID**.
- **Sleep:** triggers when the sleep frame is found.
- **Wakeup:** triggers when the wakeup frame is found.
- **Error:** triggers on the specified type of error frame. Click or tap the drop-down button of **Error Type** to select the error type: Sync, Even Odd, or Check Sum.

## 8.7.19 I2S Trigger (Option)

In I2S trigger, the oscilloscope searches for the specified data value and take it as the condition for identifying the trigger. You need to specify the serial clock line (SCLK, 1 pulse is found on the clock line once 1 bit of digital audio data is sent), frame clock line (WS, used for switch the audio channel data), and serial data line (SDA, used for transmit audio data represented in binary (2's complement)).

The figure below shows the sequential chart of I2S bus.

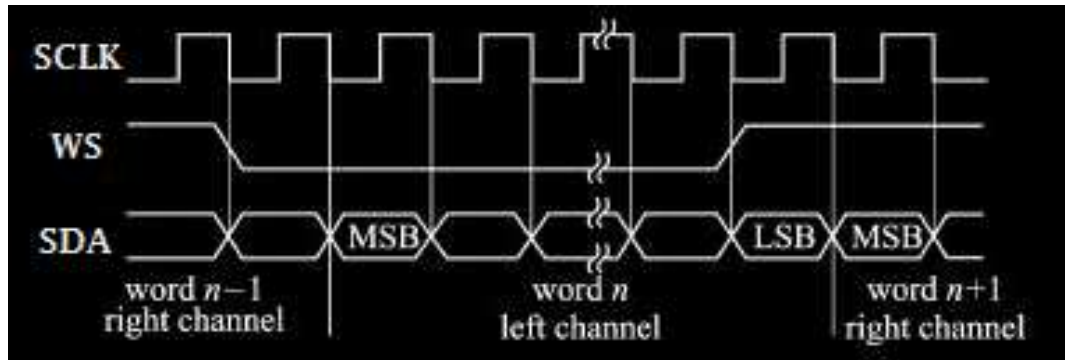

Figure 8.42 Sequential Chart of I2S Bus

### Trigger Type

Click or tap the drop-down button of **Type** to select "I2S".

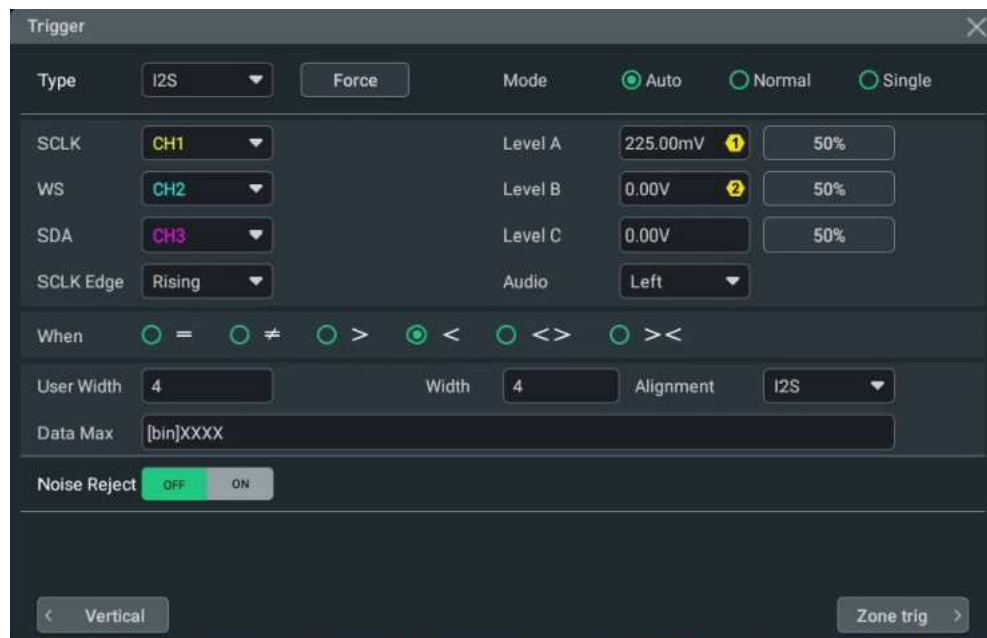
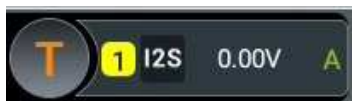

Figure 8.43 I2S Trigger Setting Menu

After a trigger type is selected, the current trigger setting information (including the trigger type, source, and level) is displayed in the trigger information label at the top of the screen, as shown in the figure below. The information will change based on the trigger settings.



## Source Selection

Click or tap the drop-down button of **SCLK**, **WS**, and **SDA** to select an analog channel or a digital channel as the source of SCLK, WS, and SDA respectively. For available channels, refer to descriptions in *Trigger Source*. The current trigger source is displayed in the trigger information label at the top of the screen.

Only when you select the channel (that has been input with signals) as the trigger source, can you obtain a stable trigger.

## Edge Type

Select the desired clock edge from the drop-down list of **SCLK Edge**.

- Rising: samples the SDA data on the rising edge of the clock.
- Falling: samples the SDA data on the falling edge of the clock.

## Audio

Click or tap the drop-down button of **Audio** to select the audio channel ("Left", "Right", or "Either").

## Trigger Condition

Click or tap the drop-down button of **When** to select the desired trigger condition.

- =: triggers when the channel's data equal the set data value. Click or tap the input field of **Data**, and then the "Format" interface is displayed. You can set the data bit that needs to be operated on. For details, refer to descriptions in *I2C Trigger*.
- ≠: triggers when the channel's data do not equal the set data value. Click or tap the input field of **Data**, and then the "Format" interface is displayed. You can set the data bit that needs to be operated on. For details, refer to descriptions in *I2C Trigger*.
- >: triggers when the channel's data are greater than the set data value. Click or tap the input field of **Data Min**, and then the "Format" interface is displayed. You can set the lower limit of the data Bits. For details, refer to descriptions in *I2C Trigger*.
- <: triggers on when the channel's data are smaller than the set data value. Click or tap the input field of **Data Max**, and then the "Format" interface is displayed. You can set the lower limit of the data Bits. For details, refer to descriptions in *I2C Trigger*.
- < >: triggers when the channel's data are smaller than the upper limit of the data value and greater than the lower limit of the data value.. Click or tap the input field of **Data Max** and **Data Min**, and then the "Format" interface is displayed. You can set the upper limit and lower limit of the data bit. For details, refer to descriptions in *I2C Trigger*.

- **> <**: triggers when the channel's data are greater than the upper limit of the data value and smaller than the lower limit of the data value. Click or tap the input field of **Data Max** and **Data Min**, and then the "Format" interface is displayed. You can set the upper limit and lower limit of the data bit. For details, refer to descriptions in *I2C Trigger*.

### User Width

Click or tap the input field of **User Width** to set it by using the pop-up numeric keypad. You can also use the specified multifunction knob to set the value. Its range is from 4 to 32.

The user width is smaller than or equal to the width.

### Width

Click or tap the input field of **Width** to set it by using the pop-up numeric keypad. You can also use the corresponding multifunction knob to set the value. Its range is from 4 to 32.

### Alignment

Click or tap the drop-down button of **Alignment** to select the alignment way for data signal.

- **I2S**: data transmission (MSB first) begins at the second edge of the WS transition.
- **LJ**: data transmission (MSB first) begins at the edge of the WS transition.
- **RJ**: data transmission (MSB first) is right-justified to the WS transition.

### Trigger Level

- **Level A**

Sets the trigger level of SCLK. Click or tap the input field of **Level A** to set the trigger level with the pop-up numeric keypad. You can also use the specified multifunction knob or the trigger level knob to adjust the specified trigger level. For details, refer to descriptions in *Trigger Level*. The current trigger level is displayed in the trigger information label at the top of the screen.

- **Level B**

Sets the trigger level of WS. Click or tap the input field of **Level B** to set the trigger level with the pop-up numeric keypad. You can also use the specified multifunction knob or the trigger level knob to adjust the specified trigger level. For details, refer to descriptions in *Trigger Level*. The current trigger level is displayed in the trigger information label at the top of the screen.

- **Level C**

Sets the trigger level of SDA. Click or tap the input field of **Level C** to set the trigger level with the pop-up numeric keypad. You can also use the specified multifunction knob or the trigger level knob to adjust the specified trigger level. For details, refer to descriptions in *Trigger Level*. The current trigger level is displayed in the trigger information label at the top of the screen.

### 8.7.20 MIL-STD-1553 Trigger (Option)

1553B is the abbreviation for the MIL-STD-1553 bus. This series can trigger on the sync field of 1553B bus, and can also trigger on the specified data word, command word, status word, or error type.

The command word, data word, and status word format of the 1553B bus is as shown in the figure below.

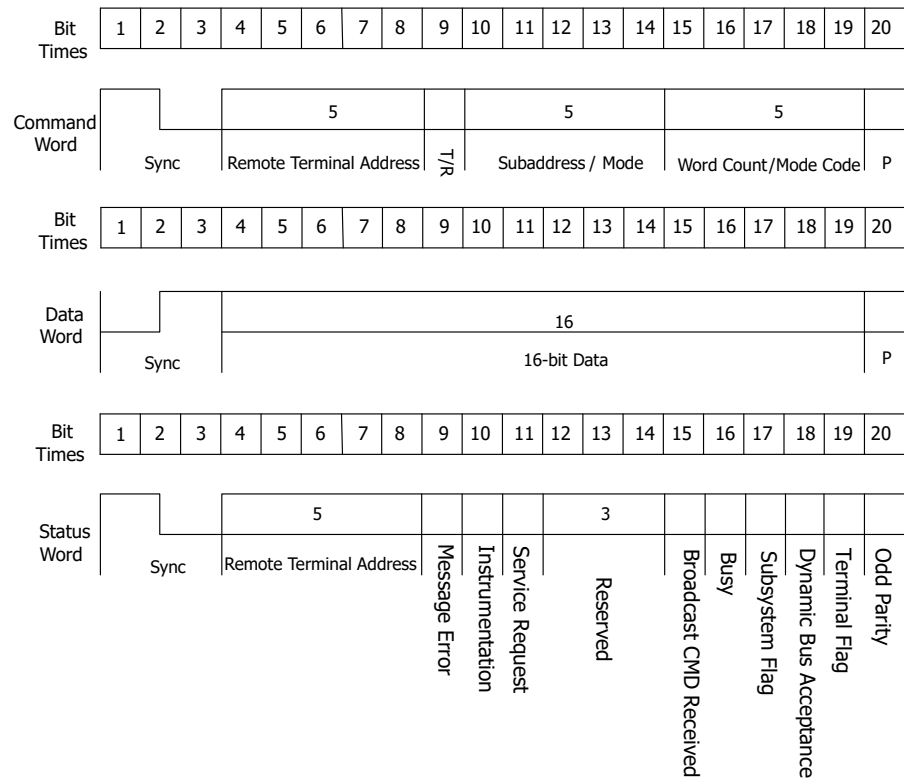

**Figure 8.44 Formats of the Command Word, Data Word, and Status Word of the 1553B Bus**

#### Trigger Type

Click or tap the drop-down button of **Type** to select "1553B" from the drop-down list. Then set the parameters for MIL-STD-1553 trigger.

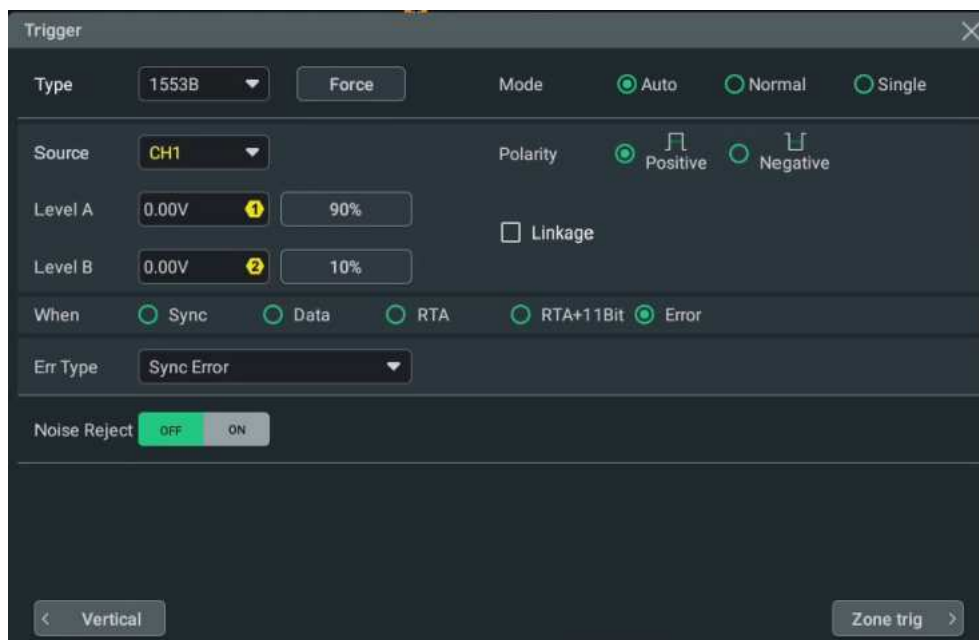

**Figure 8.45 MIL-STD-1553 Trigger Setting Menu**

After a trigger type is selected, the current trigger setting information (including trigger type, trigger source, and trigger level) is displayed in the trigger information label at the top of the screen, as shown in the figure below. The information will change based on the trigger settings.

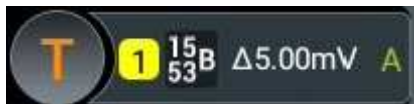



### Select the Source

Click or tap the drop-down button of **Source** to select the analog channel or the digital channel as the trigger source. For available channels, refer to descriptions in *Trigger Source*. The selected trigger source is indicated in the trigger information label at the top of the screen.

Only when you select the channel (that has been input with signals) as the trigger source, can you obtain a stable trigger.

### Polarity

In the **Polarity** item, select the desired polarity: positive polarity () or negative polarity ()

### Level Selection and Setting

After the trigger condition setting is completed, you need to adjust the trigger level to correctly trigger the signal and obtain a stable waveform.

Click or tap the **Level A/Level B** input field to set the level A/level B with the pop-up numeric keypad. You can also use the trigger level knob or use the specified multifunction knob to adjust level A/level B. Check the checkbox of **Linkage** to link Level A and Level B. The Level A and Level B will be adjusted synchronously. The upper limit and lower limit values change at the same time. The difference between upper and lower limit remains unchanged. For details, refer to descriptions in *Trigger Level*. The current trigger level is displayed in the trigger information label at the top of the screen.

### TIP

Press down the trigger level knob and rotate it to adjust Level A, Level B, and Level AB (when linkage is enabled) in sequence.

### Trigger Condition

Click or tap the drop-down button of **When** to select the desired trigger condition.

- **Sync:** triggers on the specified sync type. After this trigger condition is selected, click or tap the drop-down button of **Sync** to select the desired sync type: Data Sync, C/S Sync, or All Sync.
- **Data:** triggers on the specified data word. After this trigger condition is selected, click or tap the comparison conditions from the **Comp** menu. The available choices include =, ≠, >, <, > <, and < >.
  - =: triggers when the channel's data word equals the set data word. Click or tap the input field of **Min**, and then the "Format" interface is displayed. You can set the lower limit of the data word. For details, refer to descriptions in *I2C Trigger*.
  - ≠: triggers when the channel's data word does not equal the set data word. Click or tap the input field of **Min**, and then the "Format" interface is displayed. You can set the lower limit of the data word. For details, refer to descriptions in *I2C Trigger*.
  - >: triggers when the channel's data word is greater than the set data word. Click or tap the input field of **Min**, and then the "Format" interface is displayed. You can set the lower limit of the data word. For details, refer to descriptions in *I2C Trigger*.
  - <: triggers when the channel's data word is smaller than the set data word. Click or tap the input field of **Min**, and then the "Format" interface is displayed. You can set the lower limit of the data word. For details, refer to descriptions in *I2C Trigger*.
  - < >: triggers when the channel's data word is smaller than the upper limit of the data word and greater than the lower limit of the data word. Click or tap the input field of **Max** and **Min**, and then the "Format" interface is displayed. You can set the upper limit and lower limit of the data word. For details, refer to descriptions in *I2C Trigger*.

- > <: triggers when the channel's data word is greater than the upper limit of the data word or smaller than the trigger lower limit of the data word. Click or tap the input field of **Max** and **Min**, and then the "Format" interface is displayed. You can set the upper limit and lower limit of the data word. For details, refer to descriptions in *I2C Trigger*.
- **RTA**: triggers on the specified remote terminal address. After this trigger condition is selected, click or tap the input field of **RTA**, then the "Format" interface is displayed. You can set the remote terminal address. For details, refer to descriptions in *I2C Trigger*.
- **RTA+11Bit**: triggers on the RTA and the remaining 11 bits.  
After this trigger condition is selected:
  - Click or tap the input field of **RTA**, and then the "Format" interface is displayed. You can set the remote terminal address. For details, refer to descriptions in *I2C Trigger*.
  - Click or tap the input field of **Bit Time**, and then the "Format" interface is displayed. You can set the bit time position value to 0 (low), 1 (high), or X (don't care). For details, refer to descriptions in *I2C Trigger*.
- **Error**: triggers on the specified error type. After this trigger condition is selected, click or tap the drop-down button of **Err Type** to select the error type.
  - **Sync Error**: triggers when an invalid sync pulse is found.
  - **Check Error**: triggers when the parity bit is incorrect for the data in the word.

## 8.8 Zone Trigger

This series oscilloscope supports the zone trigger and provides two rectangle areas: Trigger zone A and Trigger zone B. You can set the trigger conditions to "Intersect" or "Not intersect". Refer to "*Rectangle Drawing*" to draw a rectangular in the waveform view. When you move your finger away from the screen, the sub-menus are displayed. Click or tap to select "Trigger zone A" or "Trigger zone B". Double-click the area to enter the specified zone trigger interface. Also, in the Trigger menu, you can click or tap **Zone trig** to enter the zone trigger interface.

### Set the Trigger Zone

In the rectangle drawing mode, the region that you draw in the waveform view called the trigger zone. In the trigger zone interface, you can set "Center X" and "Center Y" to adjust the position of the trigger zone. Set "Width" and "Height" to adjust the area of the trigger zone.

### Enable or Disable the Trigger Zone

Click or tap the ON/OFF tab for **Zone A** and **Zone B** to enable or disable the specified trigger zone in the waveform view. They can be controlled independently.

### Select the Source

Selects the source for trigger zone A and B. The available sources are CH1-CH8. The color of the zone name and the zone region are the same as that of the selected channel.

### Select the Trigger Condition

If you enable Zone A, select CH1 as the source for Zone A, select "Intersect" as the condition, the following figure is displayed.



If you enable Zone A, select CH1 as the source for Zone A, select "Not intersect" as the condition, the following figure is displayed.

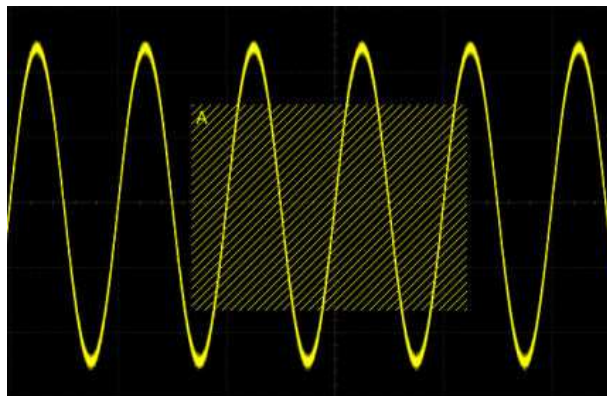

### TIP

If both trigger zone A and trigger zone B are enabled, the logic "And" operation is the final trigger condition.

### Set the Trigger Logic for the Zone Trigger

- **A or B:** triggers when one of the trigger conditions set for Zone A and Zone B is met.
- **A& B:** triggers when both of the trigger conditions set for Zone A and Zone B are met.

## 8.9 Trigger Output Connector

The trigger output connector ([**AUX OUT**]) on the rear panel of this series oscilloscope can output trigger signals (trigger hardware) based on the current setting.

Click or tap the function navigation icon  > **Utility**. Click or tap **Setup**, and then in the **AUX Out** menu, select "TrigOut". A signal which reflects the current oscilloscope capture rate can be output from [**AUX OUT**] connector each time a trigger is generated by the oscilloscope. If this signal is connected to a waveform display device to measure the frequency, the measurement result is the same as the current capture rate.

If "PassFail" is selected for the **AUX Out** menu, the instrument can output a pulse from the [**AUX OUT**] connector when a pass/failed event is detected during the pass/fail test.

## 9 Math Operation

This series of oscilloscopes can realize multiple math operations between waveforms of different channels, including arithmetic operation, spectrum operation, logic operation, function operation, and digital filter. To enter the **Math** menu, perform any of the following operations:

- Click or tap the function navigation icon  at the lower-left corner of the screen, and then select **Math** to enter the "Math" menu.
- Click or tap **Math** on the toolbar at the upper-right of the interface to enter the "Math" menu.
- Click or tap the math label (M) at the bottom of the screen. Then the math operation label is displayed below.

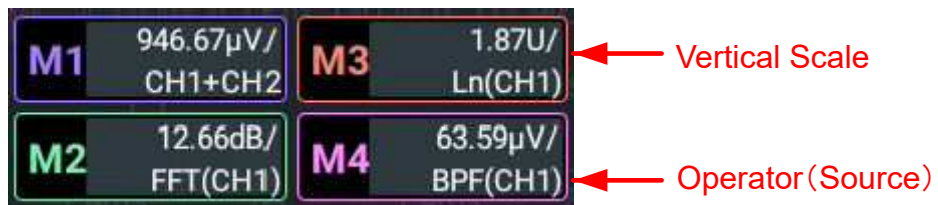

Click or tap the specified math operation label to enable the specified math operation, and the specified math operation window is displayed on the screen, as shown in *Figure 9.2*. Click or tap the specified math label again or click/tap  at the upper-right corner of the math operation window to enter the math operation setting menu.

- Press the front-panel  key to enter the math operation menu.

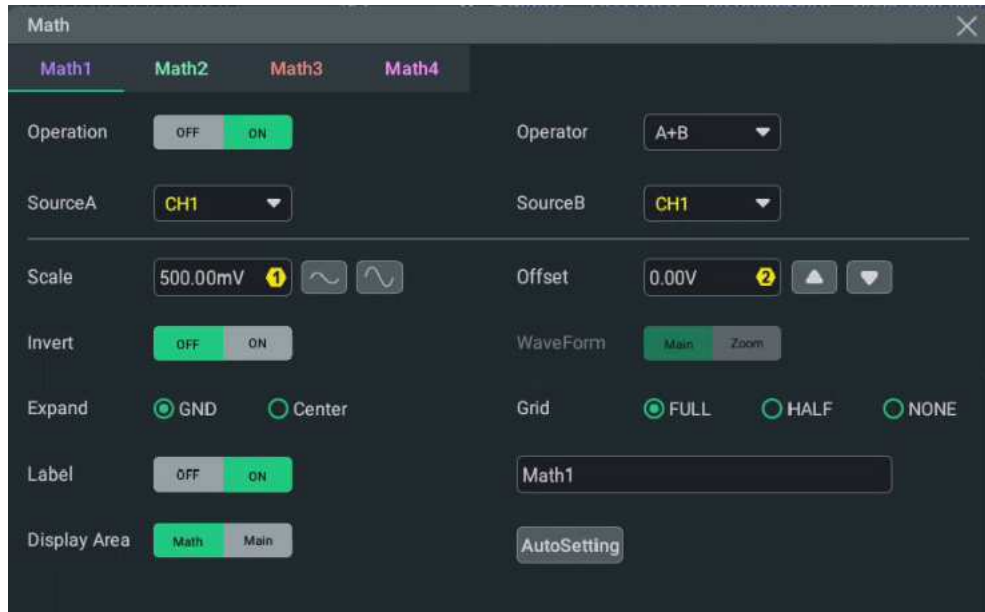

Figure 9.1 Math Operation Menu

This oscilloscope provides four math operations: Math1, Math2, Math3, and Math4. Click or tap the **Math1**, **Math2**, **Math3**, or **Math4** tab to enter the specified math operation menu. You can also slide on the current math operation menu to switch among different math operation tabs. This manual takes Math1 as an example to introduce math operation.

By default, the math operation is disabled. When the specified math operation is enabled respectively, the corresponding math operation is displayed on the screen, as shown in the figure below.

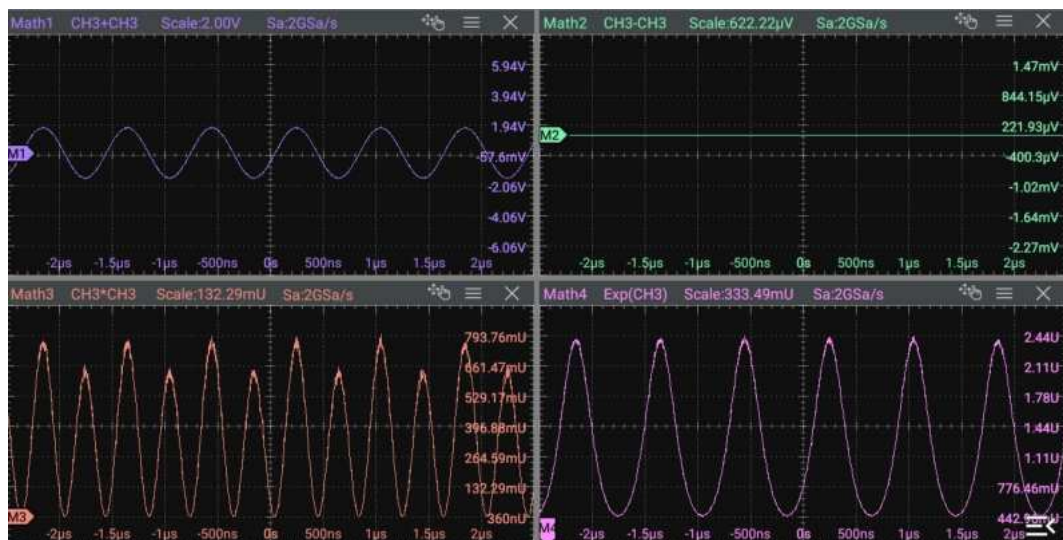



Figure 9.2 Math Operation Result Display Window

Users can drag the title bar of the display window to change the position of the window. You can also click/tap the close button  at the upper-right corner of the window to close it.

## 9.1 Arithmetic Operation

In the **Math** menu, click or tap the drop-down button of **Operator** to select the desired math operation. The arithmetic operations supported by this oscilloscope include  $A+B$ ,  $A-B$ ,  $A \times B$ , and  $A \div B$ .

- **$A+B$**  adds the waveform voltage values of signal source A and B point by point and displays the results.
- **$A-B$**  subtracts the waveform voltage values of signal source B from that of source A point by point and displays the results.
- **$A \times B$**  multiplies the waveform voltage values of signal source A and B point by point and displays the results.
- **$A \div B$**  divides the waveform voltage values of signal source A by that of source B point by point and displays the results. It can be used to analyze the Multiple relation of the two channels waveforms.

For the arithmetic operation menu, refer to [Figure 9.1](#).

### Arithmetic Operation Result Display Window

Click or tap the ON/OFF tab for **Operation** to enable or disable the display of the arithmetic operation result window. The source and the vertical scale parameters are displayed at the top of the window, as shown in the figure below.

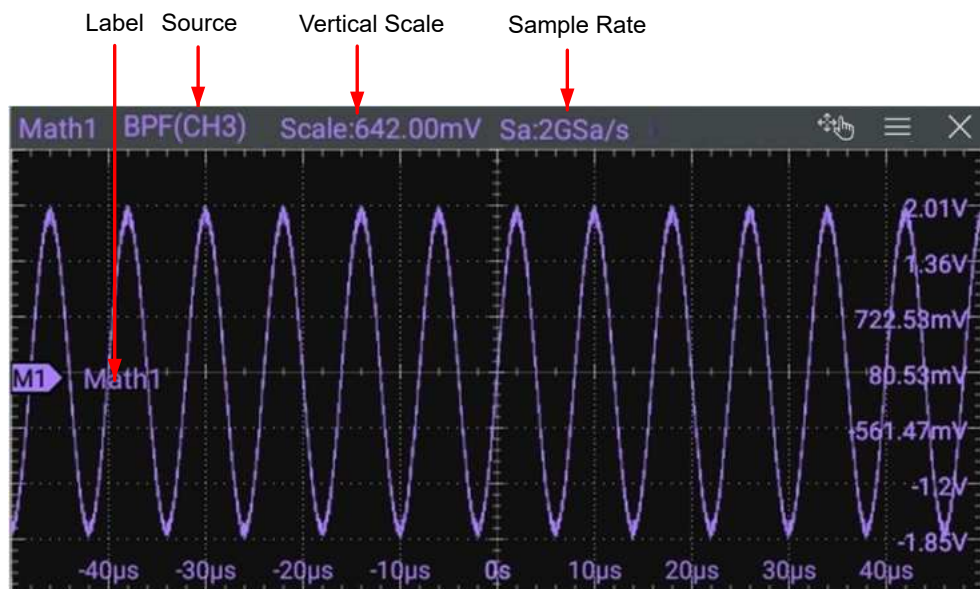

**Figure 9.3 Arithmetic Operation Result Display Window**

### Source

Click or tap the drop-down button of **SourceA** or **SourceB** to select CH1~CH8 or Ref1~Ref10. When a source channel is selected, the selected channel automatically switches to the ON state.



### TIP

In addition to CH1~CH8 and Ref1~Ref10, the available sources for Math2 also include Math1; the sources for Math3 also include Math1 and Math2; the sources for Math4 also include Math1, Math2, and Math3. The selected Math channel and operation status will automatically be enabled.

## 9.2 Function Operation

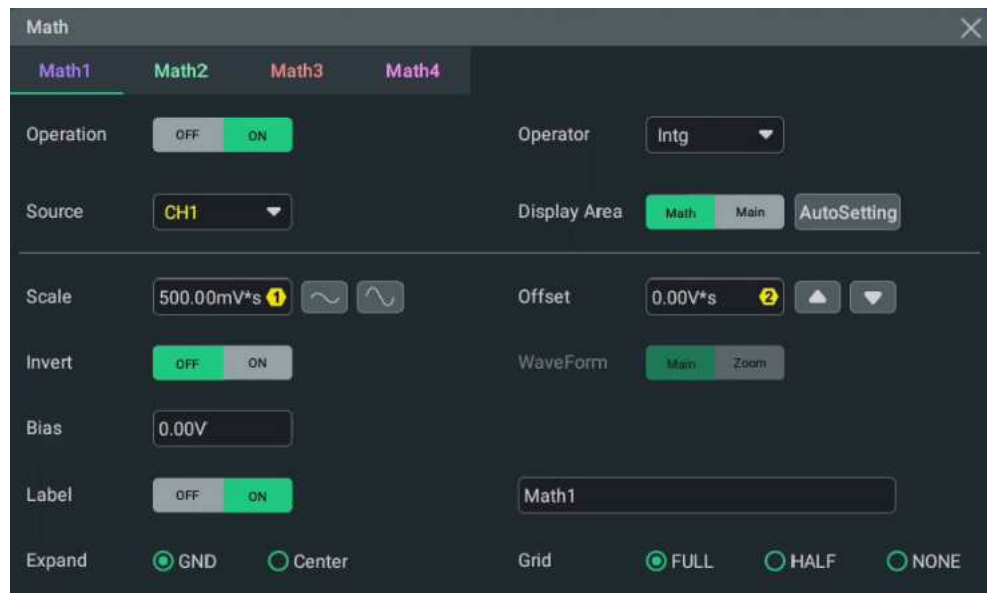

Figure 9.4 Function Operation Menu

### Function Operation Result Display Window

Click or tap the ON/OFF tab for **Operation** to enable or disable the display of the operation result window. The parameters such as source and the vertical scale are displayed at the top of the window, as shown in the figure below.

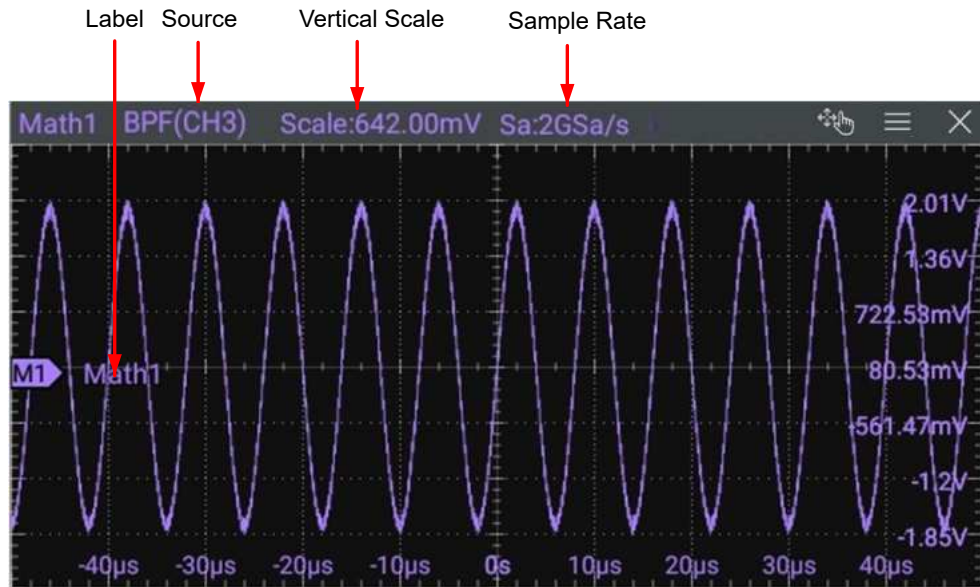

Figure 9.5 Function Operation Result Display Window

### Source

Click or tap the drop-down button of **Source** to select CH1~CH8 or Ref1~Ref10. When a source channel is selected, the selected channel automatically switches to the ON state.

### TIP

In addition to CH1~CH8 and Ref1~Ref10, the available sources for Math2 also include Math1; the sources for Math3 also include Math1 and Math2; the sources for Math4 also include Math1, Math2, and Math3. The selected Math channel and operation status will automatically be enabled.

### Auto Set

Click or tap **AutoSetting** to adjust the vertical scale and the offset of the operation results to the optimal value according to the current configuration for you to better observe.

### Parameter Setting

- When the operator is "Intg", click or tap the input field of **Offset** and use the pop-up numeric keypad to set the DC offset calibration factor of the input signal. You can also use the specified multifunction knob to set the value.
- When the operator is "Diff", click or tap the input field of **Smooth** and use the pop-up numeric keypad to set the number of smooth times for the differential operation. You can also use the specified multifunction knob to set the value.

## 9.3 FFT Operation

FFT (Fast Fourier Transform) is used to transform time-domain signals to frequency-domain components (frequency spectrum). This oscilloscope provides FFT operation function which enables you to observe the time-domain waveform and spectrum of the signal at the same time. FFT operation can facilitate the following works:

- Measure harmonic components and distortion in the system;
- Display the characteristics of the noise in DC power;
- Analyze vibration.

In the **Math** menu, click or tap the drop-down button of **Operator** to select **FFT** to go to the FFT operation menu. Then configure the parameters of FFT.

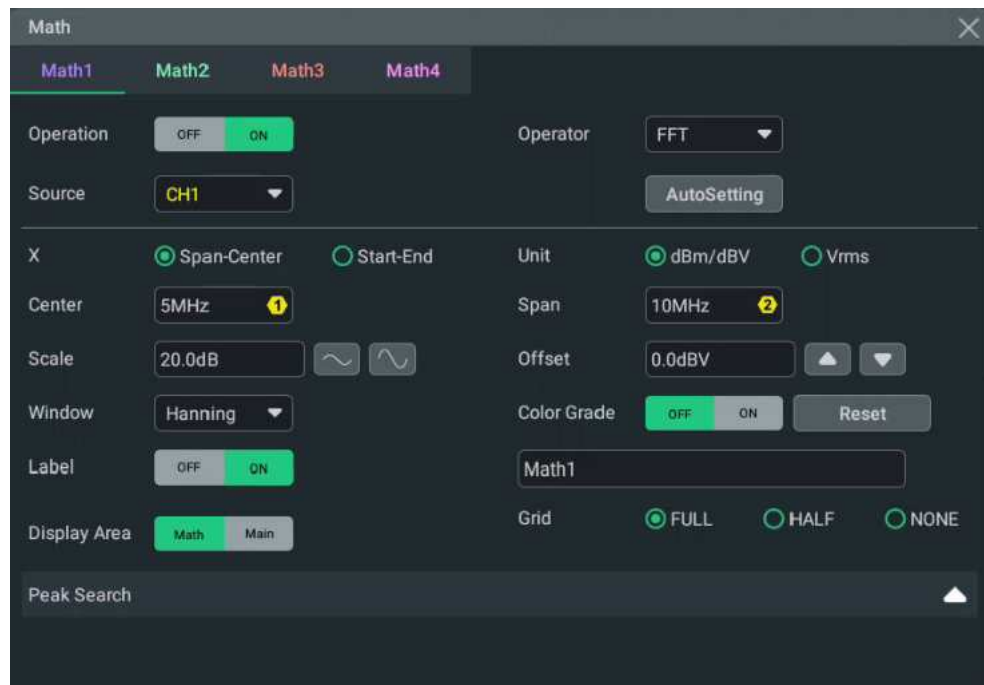

Figure 9.6 FFT Operation Menu

### Operation

Click or tap the ON/OFF tab for **Operation** to enable or disable the FFT operation result window. The parameters such as center frequency, frequency span, and resolution are displayed at the top of the window, as shown in the figure below. Of which, FFT resolution is the quotient of the sample rate and the number of FFT points. If the number of FFT points is a fixed value (65535 at most), then the higher the sample rate, the higher the resolution.

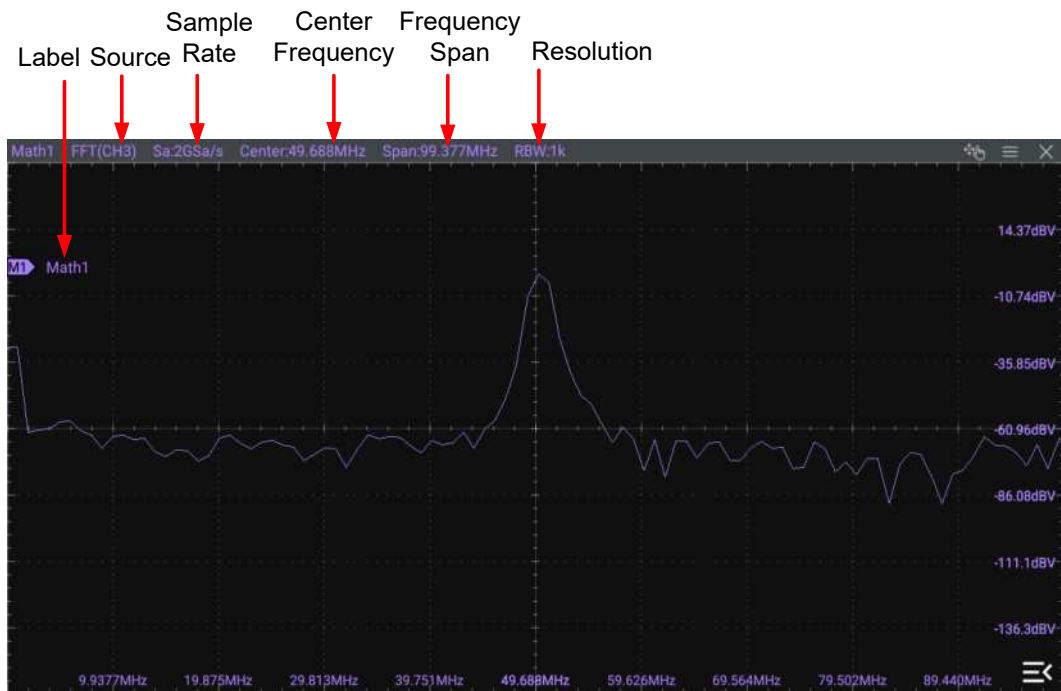

Figure 9.7 FFT Operation Result Display Window

### Source

Click or tap the drop-down button of **Source** to select CH1~CH8. When a source channel is selected, the selected channel automatically switches to the ON state.

### Frequency Range

In **X**, select "Span-Center" or "Start-End" mode and then configure the frequency range setting.

- **Span-Center (frequency span to center frequency):** Span specifies the frequency range represented by the width from the frequency at the left side of the window to the frequency at the right side of the window. Divide the frequency span by 10 to obtain the frequency per division.

Click or tap the input field of **Center Freq** to set the frequency of the frequency-domain waveform relative to the horizontal center of the screen. You can also use the specified multifunction knob to set the value. Its range is from 5 Hz to 1 GHz. Click or tap the input field of **Span** to set the frequency span with the pop-up numeric keypad. You can also use the specified multifunction knob to set the value. Its range is from 10 Hz to 1 GHz.

- **Start-End (start frequency to stop frequency):** Start frequency specifies the frequency at the left side of the window. Click or tap the input field of **Start Freq** to set the start frequency with the pop-up numeric keypad or use the specified multifunction knob to set the value. Its range is from 0 Hz to (stop frequency - 10 Hz). Stop frequency specifies the frequency at the right side of the window. Click or tap the input field of **End Freq** to set the stop frequency with the pop-

up numeric keypad or use the specified multifunction knob to set the value. Its range is from (start frequency + 10 Hz) to 1 GHz. By default, it is 10 MHz.

### Vertical Scale/Offset

Selects **dBm/dBV** or **Vrms** as the unit for **Vertical Scale** and **Offset**.

### Window Function

Spectral leakage can be considerably minimized when a window function is used. The oscilloscope provides 6 FFT window functions which have different characteristics and are applicable to measure different waveforms, as shown in the table below. You need to select the window function according to the characteristics of the waveform to be measured. Click or tap the drop-down button of **Window** to select the desired window function.

**Table 9.1 Window Function**

| Window Function | Characteristics  | Waveforms Applicable to the Window Function   |
|-----------------|--|---|
| Rectangular     | Best frequency resolution<br>Poorest amplitude resolution<br>Similar to the situation when no window is applied. | Transient or short pulse, the signal levels before and after the multiplication are basically the same<br>Sine waveforms with the same amplitudes and rather similar frequencies<br>Wide band random noise with relatively slow change of waveform spectrum |
| Blackman-Harris | Best amplitude resolution<br>Poorest frequency resolution  | Single frequency signal, searching for higher order harmonics   |
| Hanning         | Better frequency resolution and poorer amplitude resolution compared with Rectangular                            | Sine, periodic, and narrow band random noise  |
| Hamming         | A little bit better frequency resolution than Hanning  | Transient or short pulse, the signal levels before and after the multiplication are rather different  |
| Flat Top        | Measure the signals accurately   | Measure the signal that has no accurate reference and requires an accurate measurement  |

| Window Function | Characteristics             | Waveforms Applicable to the Window Function                           |
|-----------------|-----------------------------|---|
| Triangle        | Better frequency resolution | Measure the narrow band signal and that has strong noise interference |

### Color Grade

Click or tap the ON/OFF tab for **Color Grade** to enable/disable the color grade display of FFT operation results. When enabled, different colors are displayed on the screen to indicate the times of data acquisition or acquisition probability. Click or tap the **Reset** button for the **Color Grade** menu to clear the color grade display and display the color grade again.

### Peak Search

Click or tap the icon  at the right side of **Peak Search** to enter the peak search menu, as shown in the figure below.

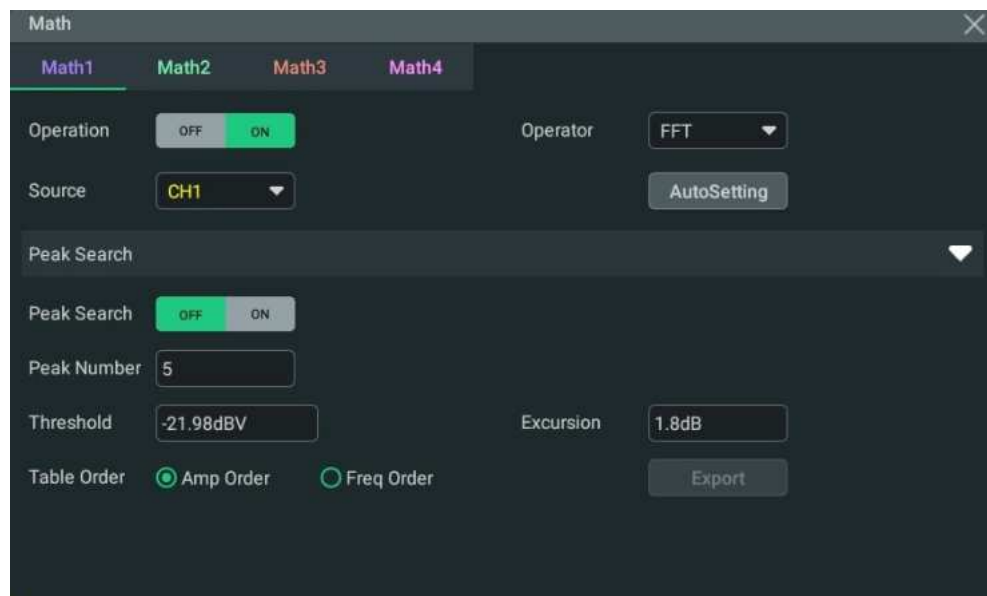



Figure 9.8 Peak Search

- **Peak Search ON/OFF:** click or tap the ON/OFF tab for **Peak Search** to enable or disable the display of the peak search window. By default, it is OFF.
- **Peak Number:** click or tap the input field of **Peak Number** and use the pop-up numeric keypad to set the number of peaks. You can also use the multifunction menu to set the value. Its range is from 1 to 15. Its default value is 5.
- **Threshold:** click or tap the input field of **Threshold** to set the threshold of the peak with the pop-up numeric keypad. You can also use the multifunction menu

to set the value. The range of the threshold is related to the current FFT scale and offset.

- **Excursion:** click or tap the input field of **Excursion** to set the excursion of the peak or use the specified multifunction knob to set the value. The minimum value of Excursion is 0 and its unit is consistent with that of FFT.
- **Table Order:** click or tap to select **Amp Order** or **Freq Order** as the sorting mode. By default, it is "Amp Order".

Click or tap **Export**, then the save setting interface is displayed. You can export the peak search results to the internal memory or the external USB storage device in CSV format. In the menu, click or tap the input field of **File Name** to set the file name; click or tap the input field of **File Path**, then the disk management menu (Disk Management) *Disk Management* is displayed. Select the desired location to save the file and then click or tap **Save** to save the peak search results.

Clicking or tapping the icon  at the right side of **Peak Search** can close the the peak search menu.

## 9.4 Logic Operation

In the **Math** menu, click or tap the drop-down button of **Operator** to select the desired math operation. The logic operations supported by this oscilloscope include  $A \& B$ ,  $A || B$ ,  $A - B$ ,  $A \wedge B$ , and  $!A$ . After selecting the desired logic operation from the drop-down button of **Operator**, you can configure its settings for the selected logic operation type.

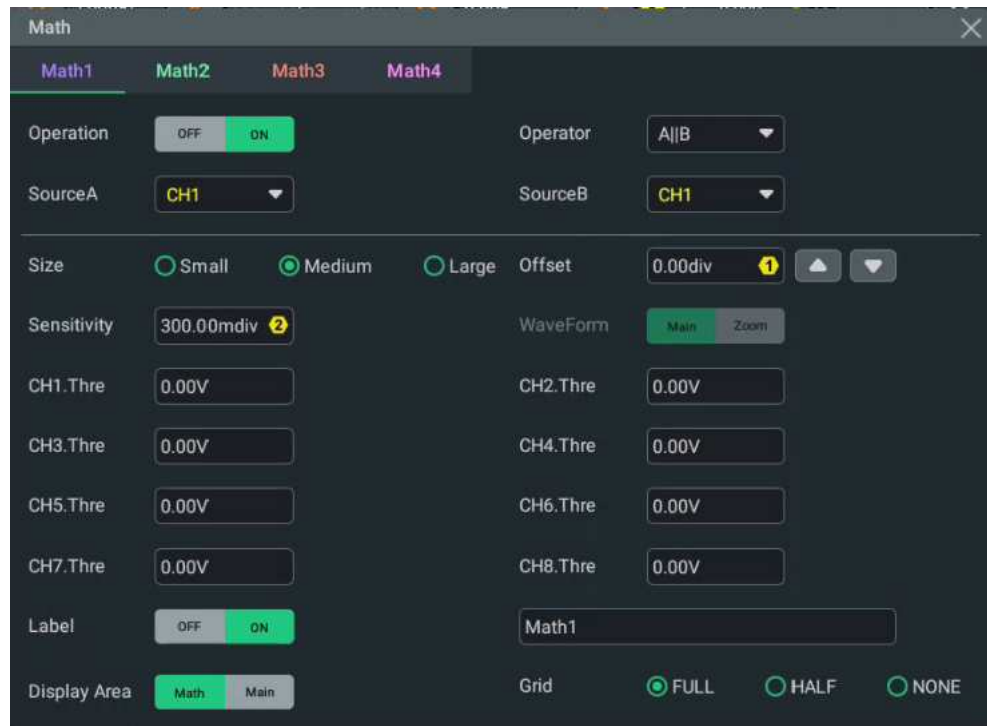

**Figure 9.9 Logic Operation Menu**

- **A&&B:** Performs logic "AND" operation on the waveform voltage values of the specified sources point by point and displays the results. In operation, when the voltage value of the source channel is greater than the threshold of the corresponding channel, it is regarded as logic "1"; otherwise it is logic "0".
- **A||B:** Performs logic "OR" operation on the waveform voltage values of the specified sources point by point and displays the results. In operation, when the voltage value of the source channel is greater than the threshold of the corresponding channel, it is regarded as logic "1"; otherwise it is logic "0".
- **A^B:** Performs logic "XOR" operation on the waveform voltage values of the specified sources point by point and displays the results. In operation, when the voltage value of the source channel is greater than the threshold of the corresponding channel, it is regarded as logic "1"; otherwise it is logic "0".
- **!A:** Performs logic "NOT" operation on the waveform voltage values of the specified sources point by point and displays the results. In operation, when the voltage value of the source channel is greater than the threshold of the corresponding channel, it is regarded as logic "1"; otherwise it is logic "0".

**Table 9.2 Logic Operation**

| A | B | A&&B | A  B | A^B | !A |
|---|---|------|------|-----|----|
| 0 | 0 | 0    | 0    | 0   | 1  |
| 0 | 1 | 0    | 1    | 1   | 1  |

| A | B | A&&B | A  B | A^B | !A |
|---|---|------|------|-----|----|
| 1 | 0 | 0    | 1    | 1   | 0  |
| 1 | 1 | 1    | 1    | 0   | 0  |

**Logic Operation Result Display Window**

Click or tap the ON/OFF tab for **Operation** to enable or disable the display of the logic operation result window. The source and the waveform sizes parameters are displayed at the top of the window, as shown in the figure below.

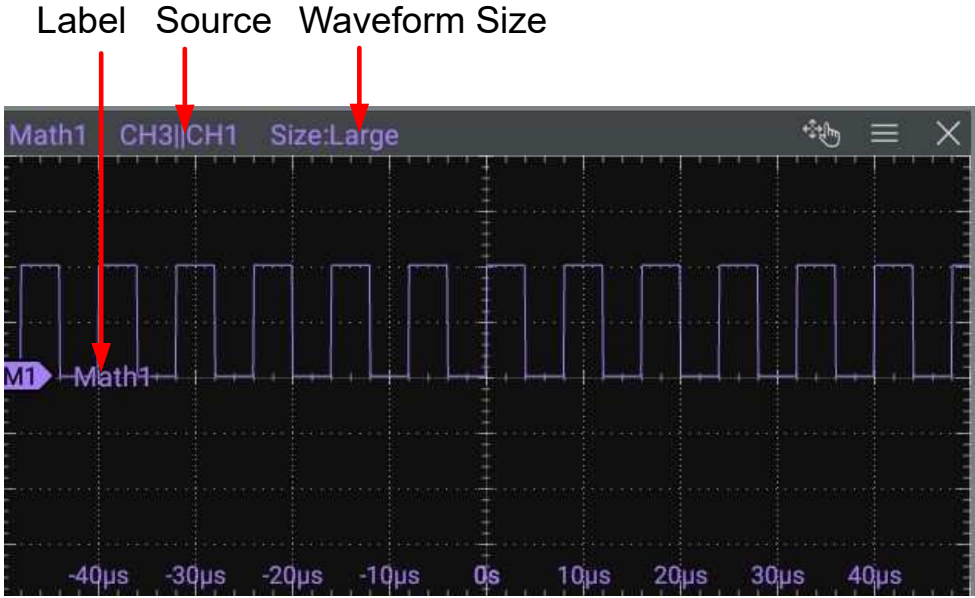

**Figure 9.10 Logic Operation Result Display Window**

**Source**

Click or tap the drop-down button of **SourceA** or **SourceB** to select the analog channels or digital channels. When a source channel is selected, the selected channel automatically switches to the ON state.



**NOTE**

For the channel sources supported by different models, refer to *Content Conventions in this Manual*.

**Waveform Size**

You can select "Small", "Medium", or "Large" as the waveform display mode.



### Sensitivity

Sets the sensitivity of the digital signal converted from the analog signal on the source. Click or tap the input field of **Sensitivity** to set the sensitivity with the pop-up numeric keypad. You can also use the specified knob to set it.

### Threshold

Sets the threshold of the channel source. Click or tap the input field of the specified channel threshold to set the threshold with the pop-up numeric keypad. You can also use the specified knob to set it.

## 9.5 Digital Filter

In the **Math** menu, click or tap the drop-down button of **Operator** to select the desired math operation. The digital filter supported by this oscilloscope includes: low-pass filter, high-pass filter, band-pass filter, and band-stop filter.

- **LowPass** only allows the signals whose frequencies are lower than the current upper limit frequency to pass.
- **HighPass** only allows the signals whose frequencies are higher than the current lower limit frequency to pass.
- **BandPass** only allows the signals whose frequencies are higher than the current lower limit frequency and lower than the current upper limit frequency to pass.
- **BandStop** only allows the signals whose frequencies are lower than the current lower limit frequency or higher than the current upper limit frequency to pass.

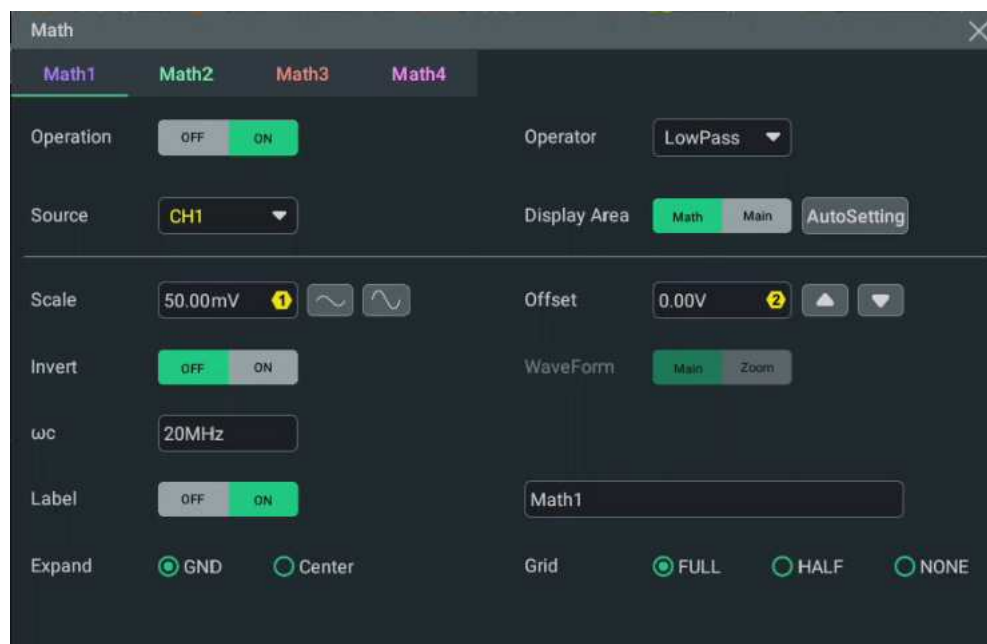

Figure 9.11 Digital Filter Menu

## Digital Filter Operation Result Display Window

Click or tap the on/off tab for the **Operation** menu to enable or disable the display of the operation result window. The source and the vertical scale parameters are displayed at the top of the window, as shown in the figure below.

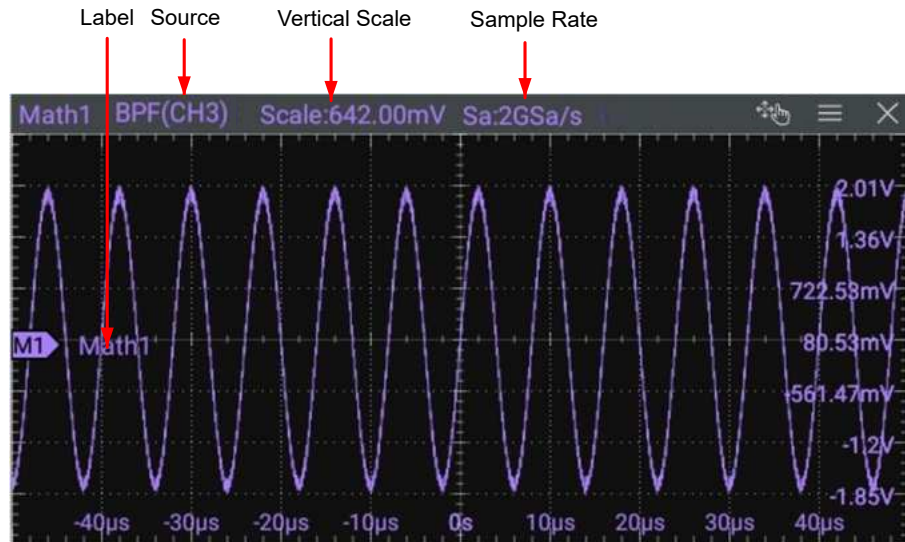

Figure 9.12 Digital Filter Operation Result Display Window

### Source

Click or tap the drop-down button of **Source** to select CH1~CH8 or Ref1~Ref10. When a source channel is selected, the selected channel automatically switches to the ON state.

### TIP

In addition to CH1~CH8 and Ref1~Ref10, the available sources for Math2 also include Math1; the sources for Math3 also include Math1 and Math2; the sources for Math4 also include Math1, Math2, and Math3. The selected Math channel and operation status will automatically be enabled.

### Frequency Limit

- **LowPass:** click or tap the input field of **wc** and use the pop-up numeric keypad to set the upper frequency limit or use the specified multifunction knob to set the value.
- **HighPass:** click or tap the input field of **wc** and use the pop-up numeric keypad to set the lower frequency limit or use the specified multifunction knob to set the value.
- **BandPass:** click or tap the input field of **wc1** and use the pop-up numeric keypad to set the lower frequency limit. Click or tap the input field of **wc2** and use the pop-up numeric keypad to set the upper frequency limit. You can also

use the specified multifunction knob to set the value to set the lower/upper frequency limit.

- **BandStop:** click or tap the input field of **ωc1** and use the pop-up numeric keypad to set the lower frequency limit. Click or tap the input field of **ωc2** and use the pop-up numeric keypad to set the upper frequency limit. You can also use the specified multifunction knob to set the value to set the lower/upper frequency limit.

The settable ranges of the upper and lower limit of frequencies are related to the Math sample rate (displayed at the bottom of the screen when the Math function is enabled). The sample rate of the analog channel or the changes of the memory depth can affect the Math sample rate.

## 9.6 Parameter Settings of the Math Operation Result

After configuring the operator and source, you can adjust the math operation result waveforms with the following methods to get better view effects.

### Display Area

Sets where the math operation result is displayed.

- **Math:** By default, the waveforms of math operation are displayed in the math operation result window.
- **Main:** displays the math operation result waveforms in the waveform view.

### Scale

Sets the vertical scale of the math operation result window. To set the vertical scale, perform the following operations:

- In the "Math" menu, rotate the specified front-panel multifunction knob indicated in the input field of **Scale** or click/tap the icon at the right side of the input field of **Scale** to increase or decrease the vertical scale. You can also click or tap the input field of Scale to input a specific value with the pop-up numeric keypad.
- When you close the Math menu, you can use the pinch & stretch gesture to adjust the vertical scale. You can also use the multifunction knob to adjust the value.

### Offset

Sets the vertical offset of the operation result window. To set the vertical offset, perform the following operations:

- In the "Math" menu, rotate the specified front-panel multifunction knob indicated in the input field of **Offset** or click/tap the icon at the right side of the input field of **Offset** to increase or decrease the vertical offset. You can also click

or tap the input field of Scale to input a specific value with the pop-up numeric keypad.

- When you close the Math menu, you can use the drag gesture to adjust the vertical offset. To use the multifunction knob to adjust the value, you should move the cursor to the input field before you close the menu, then the specified knob appears so that you can use the specified knob to adjust the value.

### Auto Setting

Click or tap **Auto Setting**, and then the vertical scale and offset of the math operation result window will be automatically adjusted to optimal values based on the current configurations, so that users can get a better observation of the results.

### Invert

Sets to enable or disable the inverted display of the waveform. For setting methods, refer to descriptions in *Waveform Invert*.

FFT operation does not support Invert.

### Waveform

Sets the time base region of the math operation waveform.

- **Main:** the waveform is within the main time base region. By default, it is Main.
- **Zoom:** the waveform is within the zoomed time base region.

When you select "Zoom", you need to enable *Zoom Mode (Delayed Sweep)* in *Horizontal System*.

FFT does not support zoom region display.

### Vertical Expansion

Sets the vertical expansion of the math operation result window.

- **GND:** when the vertical scale is changed, the math operation waveform will be expanded or compressed around the signal ground level position.
- **Center:** when the vertical scale is changed, the math operation waveform will be expanded or compressed around the screen center.

FFT does not support Center expansion.

### Label

Sets whether to enable or disable the display of the math operation label of the waveform. For setting methods, refer to descriptions in *Channel Label*.

**Grid**

When the Display Area is set to "Math", you can set the screen grid. For setting methods, refer to *To Set the Screen Grid*.

## 10 Measurements

This series oscilloscope provides the quick measurements after "Auto" is selected, auto measurements for 41 waveform parameters, as well as the cursor measurement function.

### 10.1 Measurement Parameter

This oscilloscope supports the measurement of 41 waveform parameters, including time parameters, count values, delay and phase parameters, voltage parameters and other parameters.

#### 10.1.1 Time Parameters

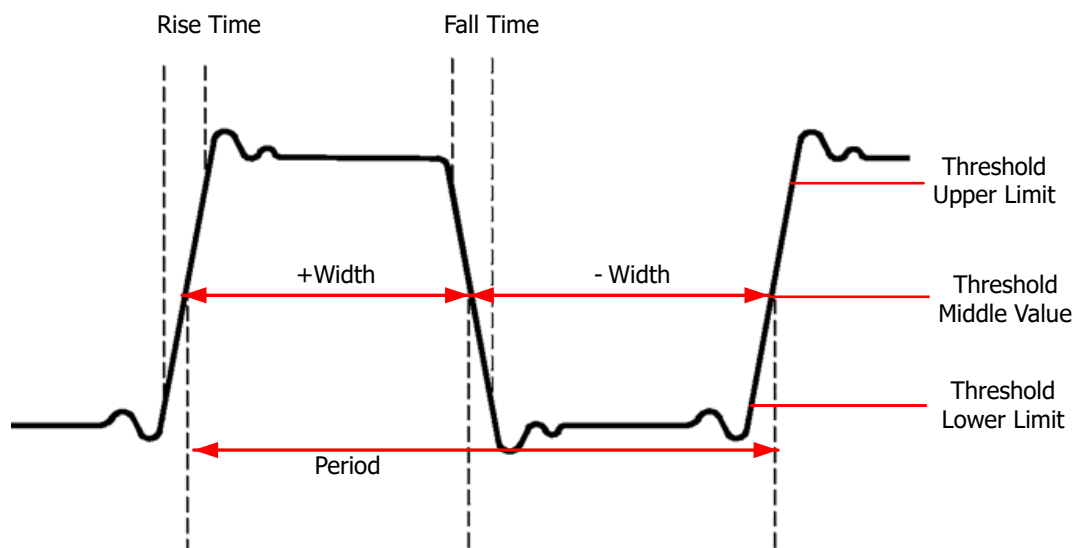

Figure 10.1 Time Parameters

- **Period:** defined as the time between the middle threshold points of two consecutive, like-polarity edges.
- **Frequency:** defined as the reciprocal of period.
- **Rise Time:** indicates the time for the signal amplitude to rise from the threshold lower limit to the threshold upper limit.
- **Fall Time:** indicates the time for the signal amplitude to rise from the threshold upper limit to the threshold lower limit.
- **+Width:** indicates the time between the threshold middle value of a rising edge to the threshold middle value of the next falling edge.
- **-Width:** indicates the time between the threshold middle value of a falling edge to the threshold middle value of the next rising edge.

- **+Duty:** indicates the ratio of the positive pulse width to the period.
- **-Duty:** indicates the ratio of the negative pulse width to the period.
- **Tvmax:** indicates the time that corresponds to the maximum value of the waveform (Vmax).
- **Tvmin:** indicates the time that corresponds to the minimum value of the waveform (Vmin).

The default values for threshold upper limit, threshold middle value, and threshold lower limit are 90%, 50%, and 10%, respectively.

## 10.1.2 Count Values

The default values for threshold upper limit and threshold lower limit are 90% and 10%, respectively.

### Positive Pulse Count

It is specified as the number of positive pulses that rise from under the threshold lower limit to above the threshold upper limit.

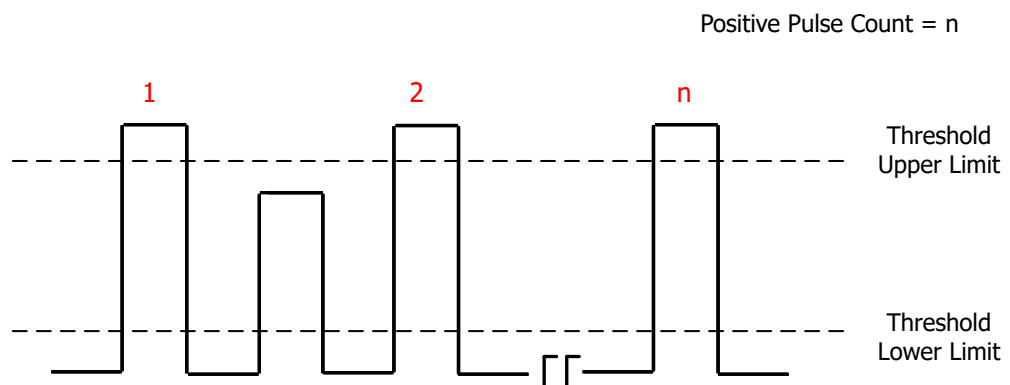

### Negative Pulse Count

It is specified as the number of negative pulses that fall from above the threshold upper limit to below the threshold lower limit.

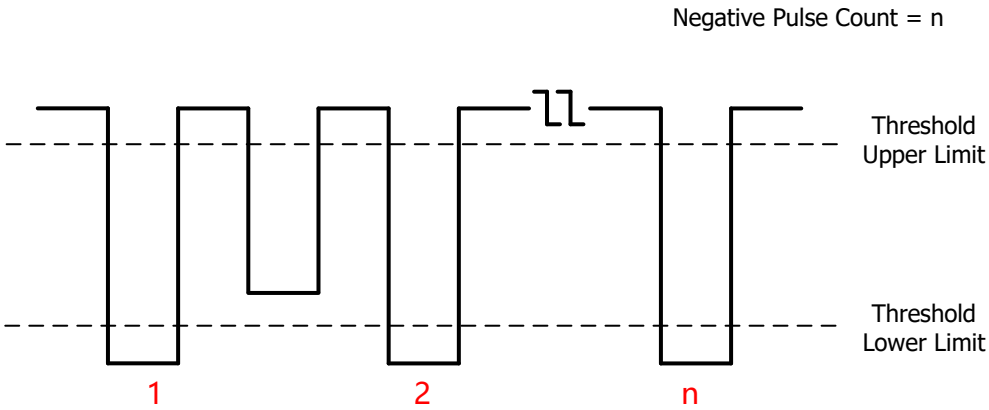

**Rising Edge Count**

It is specified as the number of rising edges that rise from under the threshold lower limit to above the threshold upper limit.

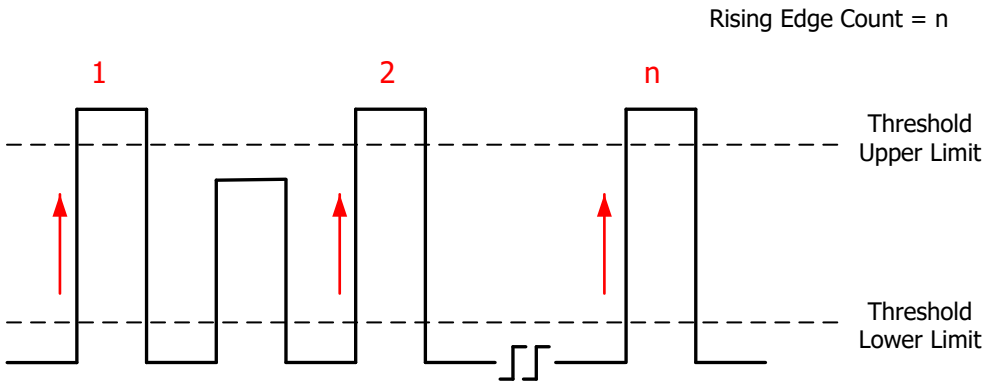

**Falling Edge Count**

It is specified as the number of falling edges that fall from above the threshold upper limit to below the threshold lower limit.

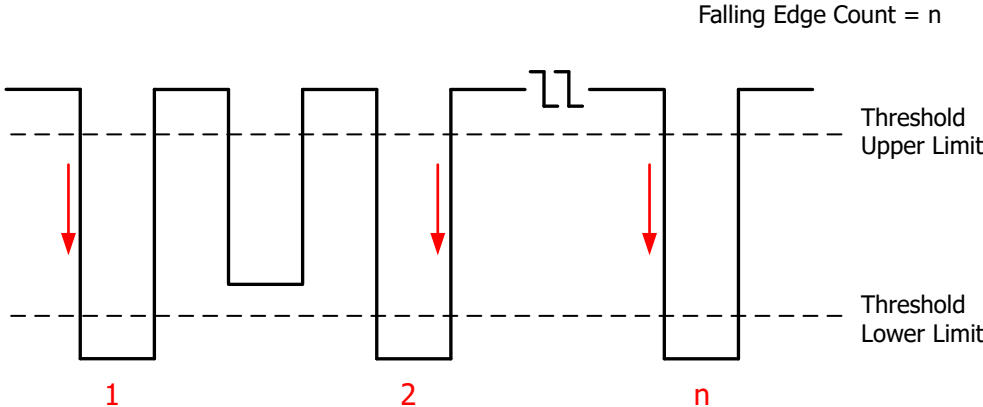

### 10.1.3 Delay and Phase Parameters

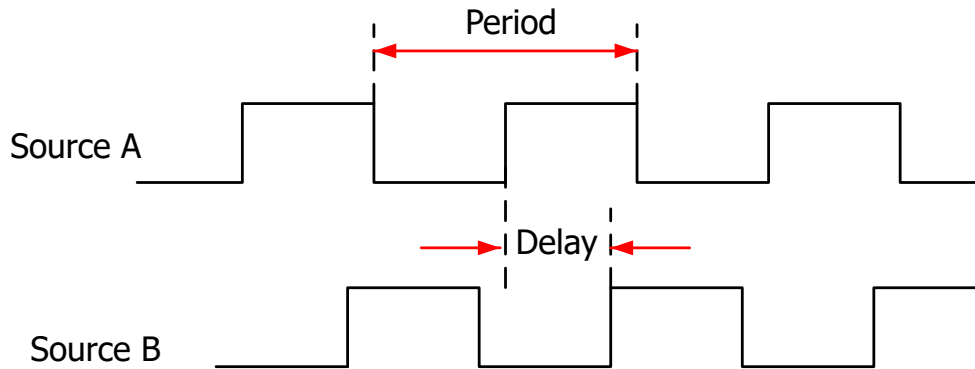

**Figure 10.2 Delay and Phase Parameters**

1. **Delay(r-r):** indicates the time difference between the threshold middle values of the rising edge of Source A and that of Source B. Negative delay indicates that the rising edge of Source A occurred after that of Source B.
2. **Delay(f-f):** indicates the time difference between the threshold middle values of the falling edge of Source A and that of Source B. Negative delay indicates that the falling edge of Source A occurred after that of Source B.
3. **Delay(r-f):** indicates the time difference between the threshold middle values of the rising edge of Source A and the falling edge of Source B. Negative delay indicates that the rising edge of Source A occurred after the falling edge of Source B.
4. **Delay(f-r):** indicates the time difference between the threshold middle values of the falling edge of Source A and the rising edge of Source B. Negative delay indicates that the falling edge of Source A occurred after the rising edge of Source B.
5. **Phase(r-r):** indicates the phase deviation between the threshold middle values of the rising edge of Source A and that of Source B. The phase formula is as follows:

$$PhaseA_{RB_R} = \frac{DelayA_{RB_R}}{Period_{sourceA}} \times 360^\circ$$

Wherein,  $PhaseA_{RB_R}$  represents Phase(r-r),  $DelayA_{RB_R}$  represents Delay(r-r), and  $Period_{sourceA}$  represents the period of Source A.

6. **Phase(f-f):** indicates the phase deviation between the threshold middle values of the falling edge of Source A and that of Source B. The phase formula is as follows:

$$PhaseA_{FB_F} = \frac{DelayA_{FB_F}}{Period_{sourceA}} \times 360^\circ$$

Wherein,  $Phase_{A_F B_F}$  represents Phase (f-f),  $Delay_{A_F B_F}$  represents Delay(f-f), and  $Period_{sourceA}$  represents the period of Source A.

- 7. Phase(r-f):** indicates the phase deviation between the threshold middle values of the rising edge of Source A and the falling edge of Source B. The phase formula is as follows:

$$Phase_{A_R B_F} = \frac{Delay_{A_R B_F}}{Period_{sourceA}} \times 360^\circ$$

Wherein,  $Phase_{A_R B_R}$  represents Phase (r-r),  $Delay_{A_R B_R}$  represents Delay(r-r), and  $Period_{sourceA}$  represents the period of Source A.

- 8. Phase(f-r):** indicates the phase deviation between the threshold middle values of the falling edge of Source A and the rising edge of Source B. The phase formula is as follows:

$$Phase_{A_F B_R} = \frac{Delay_{A_F B_R}}{Period_{sourceA}} \times 360^\circ$$

Wherein,  $Phase_{A_F B_R}$  represents Phase (f-r),  $Delay_{A_F B_R}$  represents Delay(f-r), and  $Period_{sourceA}$  represents the period of Source A.



#### TIP

- Source A and Source B can be any analog channels and Math1~Math4.
- The default threshold middle value is 50%.

## 10.1.4 Voltage Parameters

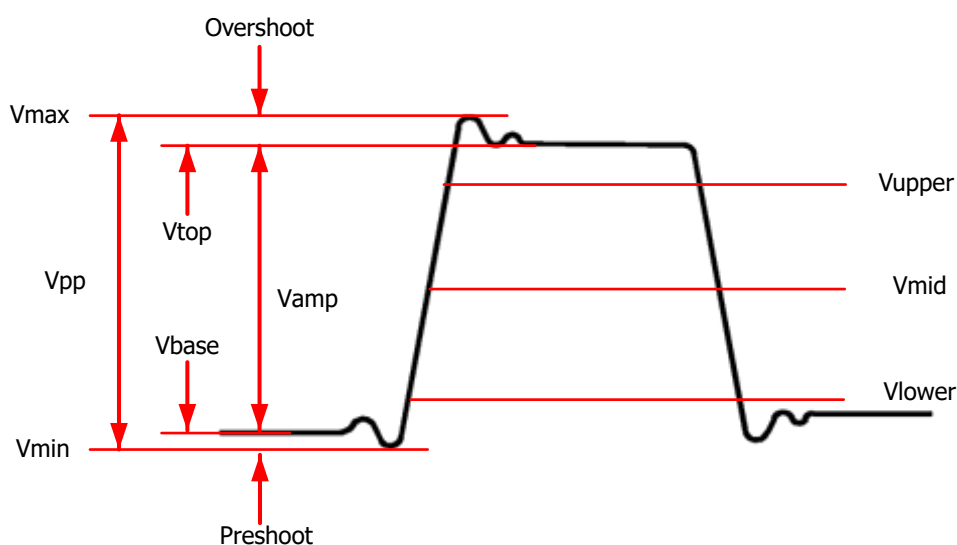

Figure 10.3 Voltage Parameters

1. **Vmax:** indicates the voltage value from the highest point of the waveform to the GND.
2. **Vmin:** indicates the voltage value from the lowest point of the waveform to the GND.
3. **Vpp:** indicates the voltage value from the highest point to the lowest point of the waveform.
4. **Vtop:** indicates the voltage value from the flat top of the waveform to the GND.
5. **Vbase:** indicates the voltage value from the flat base of the waveform to the GND.
6. **Vamp:** indicates the voltage value from the top of the waveform to the base of the waveform.
7. **Vupper:** indicates the actual voltage value that corresponds to the threshold maximum value.
8. **Vmid:** indicates the actual voltage value that corresponds to the threshold middle value.
9. **Vlower:** indicates the actual voltage value that corresponds to the threshold minimum value.
10. **Vavg:** indicates the arithmetic average value on the whole waveform or in the gating area. The formula is shown as follows:

$$Average = \frac{\sum_{i=1}^n x_i}{n}$$

Wherein,  $x_i$  is the  $i$ th point, and  $n$  is the number of points being measured.

11. **VRMS:** indicates the root mean square value on the whole waveform or in the gating area. The formula is as follows:

$$RMS = \sqrt{\frac{\sum_{i=1}^n x_i^2}{n}}$$

Wherein,  $x_i$  is the measurement result of the  $i$ th point, and  $n$  is the number of points being measured.

12. **Per.VRMS:** indicates the root mean square value within a period. The formula is as shown above.
13. **Overshoot:** indicates the ratio of the difference between the maximum value and the top value of the waveform to the amplitude value.
14. **Preshoot:** indicates the ratio of the difference between the minimum value and the base value of the waveform to the amplitude value.

**15. AC RMS:** indicates the root-mean-square value of the waveforms, with the DC component removed. The formula is shown as follows:

$$\text{Std.Dev} = \sqrt{\frac{\sum_{i=1}^n (x_i - \text{Average})^2}{n}}$$

Wherein,  $x_i$  is the amplitude of the  $i$ th point, *Average* is the waveform average value, and  $n$  is the number of points being measured.

## 10.1.5 Other Parameters

- **Positive Slew Rate:** On the rising edge, first calculate the difference between the high value and the low value, then use the difference to divide the corresponding time value to obtain the positive slew rate.
- **Negative Slew Rate:** On the falling edge, first calculate the difference between the low value and the high value, then use the difference to divide the corresponding time value to obtain the negative slew rate.
- **Area:** indicates the area of the whole waveform within the screen. The unit is V\*s. The area of the waveform above the zero reference (namely the vertical offset) is positive, and the area of the waveform below the zero reference is negative. The area measured is the algebraic sum of the area of the whole waveform within the screen.
- **Period Area:** indicates the area of the first period of waveform on the screen. The unit is V\*s. The area of the waveform above the zero reference (namely the vertical offset) is positive, and the area of the waveform below the zero reference is negative. The area measured is the algebraic sum of the whole period area.

## 10.2 To Select the Measurement Item

In the **Measure** menu, click or tap **Horizontal**, **Vertical**, or **Other** to go to the desired menu. You can also slide to select the measurement item to enter the corresponding interface. Click or tap any of the measurement items to enable the measurements. This series oscilloscope allows you to enable measurements of up to 14 items at the same time.

### TIP

You can also refer to *Multi-pane Windowing* to enable all measurements.

- **Vertical:** Vmax, Vmin, Vpp, Vtop, Vbase, Vamp, Vupper, Vmid, Vlower, Vavg, VRMS, Per. VRMS, Overshoot, Preshoot, Area, Per.Area, and AC.RMS.



- **Horizontal:** Period, Frequency, Rise Time, Fall Time, +Width, -Width, +Duty, -Duty, Positive Pulse Count, Negative Pulse Count, Rising Edge Count, Falling Edge Count, Tvmax, Tvmin, +Slew Rate, and -Slew Rate.
- **Other:** Delay (r-r), Delay (r-f), Delay (f-r), Delay (f-f), Phase (r-r), Phase (r-f), Phase(f-r), and Phase (f-f).

After selecting the specified measurement item, the "Result" sidebar on the right side of the screen displays the measurement results of the specified measurement item. You can click or tap the measurement results of the specified item, then its sub-menus are displayed. You can perform relevant settings, such as setting the measurement parameters and removing the measurement results.

## 10.3 Measurement Settings

You can enter the measurement setting menu in the following ways:

- In the **Measure** menu, click or tap the **Setting** button to enter the measurement setting menu.
- Click or tap the measurement results labels on the "Result" sidebar on the right side of the screen and then select **Setting** in the pop-up window.

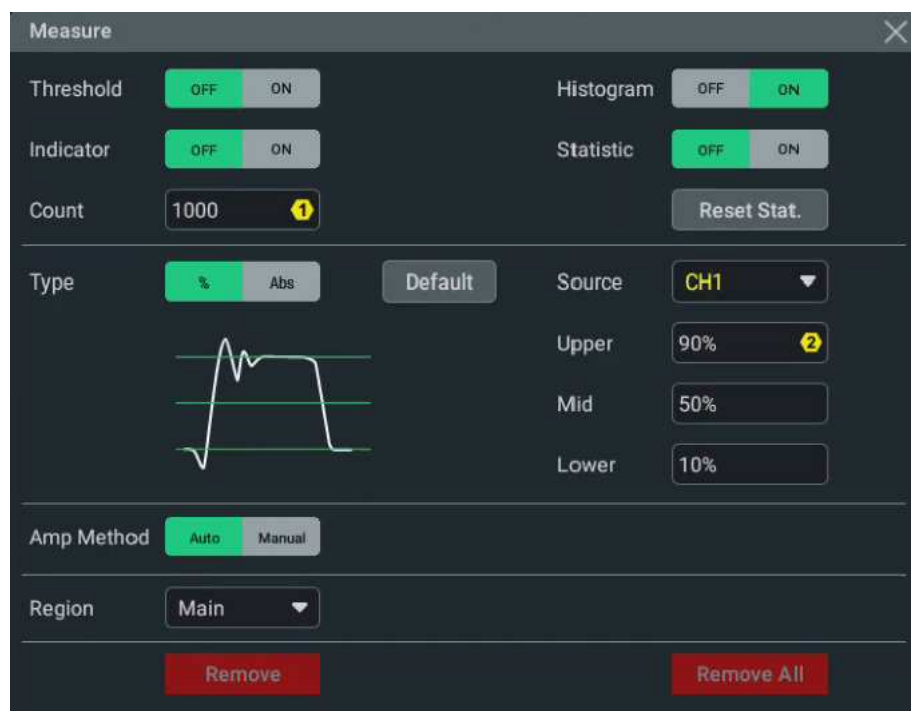

Figure 10.4 Measurement Settings Menu

## Histogram

When completing the measurement of specified parameters, you can view the data distribution of measurement results through the "Histogram" function.

Click or tap the ON/OFF tab for **Histogram** to enable (**ON**) or disable (**OFF**) the histogram function.

When the histogram function is enabled, the histogram window opens and displays the histogram waveform, and the measurement histogram label is displayed in the **Result** sidebar on the right side of the screen. The histogram measurement results include the following parameters.

- Type: indicates the measurement items.
- Sum: indicates the sum of all bins (buckets) in the histogram.
- Peaks: indicates the maximum number of hits in any single bin.
- Max: indicates the value that corresponds to the maximum bin that has any hits.
- Min: indicates the value that corresponds to the minimum bin that has any hits.
- Pk\_Pk: indicates the Delta between the max. value and the min. value.
- Mean: indicates the average value of the histogram.
- Median: indicates the median value of the histogram.
- Mode: indicates the mode value of the histogram.
- Bin width: indicates the width of each bin (bucket) in the histogram.
- Sigma: indicates the standard deviation of the histogram.
- XScale: indicates the horizontal scale of the histogram. It is 100 times the value of Bin width.

## Indicator

Click or tap the ON/OFF tab for **Indicator** to enable (**ON**) or disable (**OFF**) the indicator function.

If enabled, one or more cursors will be displayed on the screen. Before enabling the indicator, you need to enable at least one auto measurement parameter and the number of cursors will change with the measurement parameter enabled.

### TIP

When no measurement parameter is selected or there is no source input, the indicator is not available. The indicator changes when the waveform is expanded or compressed horizontally.



## Measurement Threshold

- First, select **%** or **Abs** as the display type.
- Click or tap the drop-down button of **Source** to select the desired channel. You can select from analog channel or Math1 to Math4.



### NOTE

For the supported channels of each model, refer to *Content Conventions in this Manual*

- Click or tap the input field of **Upper** and use the pop-up numeric keypad to set the upper limit of the measurement or use the corresponding multifunction knob to set the value. When the upper limit is set to be smaller than or equal to the current middle value, a prompt message "Set at lower limit" is displayed. Then, the oscilloscope will automatically adjust the upper limit and make it greater than the middle value. By default, it is 90%. The default absolute value varies with the vertical setting of the channel.
- Click or tap the input field of **Mid** and use the pop-up numeric keypad to set the middle value of the measurement or use the corresponding multifunction knob to set the value. The middle value is limited by the settings of the upper limit and lower limit. By default, it is 50%. The default absolute value varies with the vertical setting of the channel.
- Click or tap the input field of **Lower** and use the pop-up numeric keypad to set the lower limit of the measurement or use the corresponding multifunction knob to set the value. When the lower limit is set to be greater than or equal to the current middle value, a prompt message "Set at upper limit" is displayed. Then, the oscilloscope will automatically adjust the lower limit and make it smaller than the middle value. By default, it is 10%. The default absolute value varies with the vertical setting of the channel.
- Click or tap **Default** to return the upper, middle, and lower limits to their default values.

Click or tap the ON/OFF tab for **Threshold** to enable or disable the threshold settings.



### TIP

Modifying the threshold will affect the measurement results of time, delay, and phase parameters.

## Measurement Range

Click or tap the drop-down button of the **Region** to select "Main" or "Zoom".

- **Main:** indicates that the measurement range is within the main time base region.
- **Zoom:** indicates that the measurement range is within the zoomed time base region.

To use "Zoom", you need to enable the *Zoom Mode (Delayed Sweep)* first.

- **Cursor** When **CursorAB** is set to ON, the two cursors will be displayed on the screen. At this time, click or tap the input field of **CursorA** and **CursorB** respectively and use the pop-up numeric keypad to modify the cursor position and determine the measurement range.

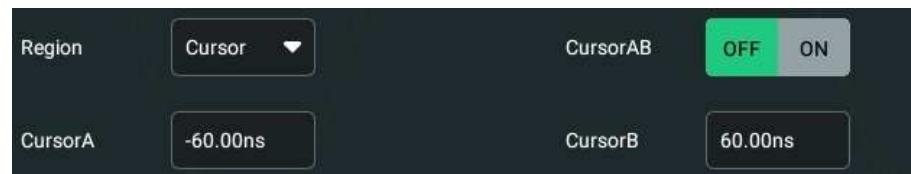

### Amplitude Measurement Method

Click or tap **Auto** or **Manual** as the amplitude measurement method, which affects the measurement method for the top and base values.

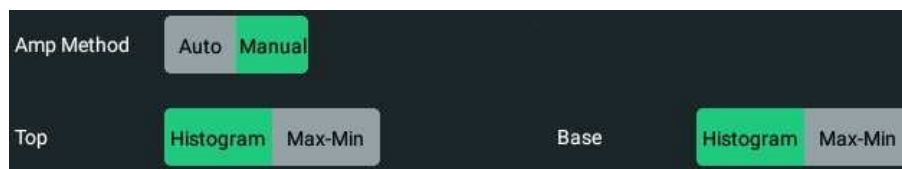

If you select "Manual", set the following parameters:

- Click or tap the **Top** toggle button to select **Histogram** or **Max-Min** as the top value measurement method.
- Click or tap the **Base** toggle button to select **Histogram** or **Max-Min** as the base value measurement method.



#### TIP

If you select "Manual" for the amplitude method, the measurement results of other parameters may be affected.



"Histogram" and "Max-Min" are the internal measurement algorithm for the oscilloscope.

## 10.4 Statistical Measurement Results

The measurement results of all current measurement items are displayed in the Result sidebar.



### Display measurement results of all statistical items

Click or tap  at the lower-right of the measurement item in the Result sidebar to expand the label to display all the statistical items. Click or tap  to collapse the label to display the current value.

In a setting menu of the specified measurement item, you can click or tap the ON/OFF tab for **Statistic** to display all statistics or only the current value of the measurement item on the Result sidebar.

### Set the measurement statistics counts

Click or tap the input field of **Count** and use the pop-up numeric keypad to set the count value. You can also use the corresponding multifunction knob to set the value. Its range is from 2 to 100000. Its default value is 1000.

### Reset the statistics results

Click or tap any measurement item in the Result sidebar at the right side of the screen and a window is displayed. Click or tap **Reset Stat.** to clear the history statistics data and makes statistics again. You can also click or tap **Reset Stat.** in the measurement setting menu.

## 10.5 To Remove the Measurement Results

After completing the measurement, you can remove the specified measurement item or remove all the measurement items.

### Remove the Specified Measurement Item



- In the **Setting** menu of the specified measurement item, click or tap **Remove** to remove the current measurement item.
- Click or tap the specified measurement item result list. Then the sub-menu is displayed. Click or **Remove** to remove the current measurement item.

- Click or tap to drag the specified measurement item result list to the right to remove it quickly.

#### Remove All Measurement Items

- In the **Setting** menu, click or tap **Remove All** to remove all of the measurement items.
- Click or tap any measurement item shown in the result list. Then the sub-menu is displayed. Click or tap **Remove All** to remove results of all the measurement items.

## 10.6 Auto Measurement

When the oscilloscope is properly connected and received a valid signal, click or tap the function navigation icon  at the lower-left corner of the screen to select the **Auto** icon to enable the waveform auto setting function and open the auto setting function menu. You can also press  on the front panel to enable the waveform auto setting and open the auto setting interface.



- Click or tap the first icon, and then signal in two periods is displayed automatically on the screen. Meanwhile, the system will make measurements for the "period" and "frequency" of the currently displayed waveforms. The measurement results are displayed at the right side of the screen under the "Result" list.
- Click or tap the second icon, and then multiple periods of the signal are displayed automatically on the screen. Meanwhile, the system will make measurements for the "period" and "frequency" of the currently displayed waveforms in a multiple periods. The measurement results are displayed at the right side of the screen under the "Result" list.
- Click or tap the third icon, and then "rise time" measurement item is enabled. Its measurement results are displayed at the right side of the screen under the "Result" list. By default, it is intended for the fast edge signal.
- Click or tap the fourth icon, and then "fall time" measurement item is enabled. Its measurement results are displayed at the right side of the screen under the "Result" list. By default, it is intended for the fast edge signal.
- Click or tap the fifth icon to cancel the auto setting and recovers to the parameter settings prior to pressing the **Auto** key.

- Click or tap the sixth icon to enter the **Auto Config** sub-menu under the **Utility** menu. For details on how to operate this menu, please refer to *Auto Config*.



### TIP

The waveform auto setting function requires that the frequency of the signal should be greater than or equal to 35 Hz, the amplitude greater than or equal to 10 mV. If not meeting the conditions, the waveform auto setting function may be invalid.

## 10.7 Cursor Measurements

Cursor measurement can measure the X axis values (e.g. Time) and Y axis values (e.g. Voltage) of the selected waveform. Before making cursor measurements, connect the signal to the oscilloscope to acquire stable display. The cursor measurement function provides the following two cursors.

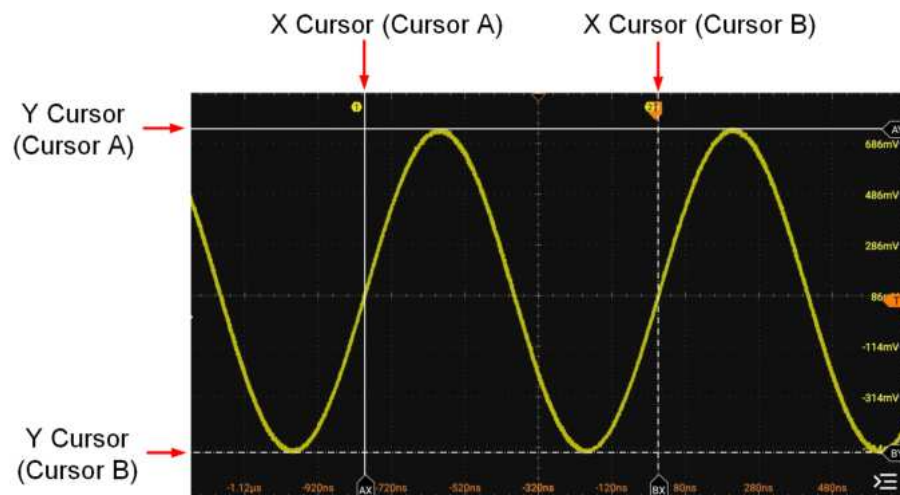



Figure 10.5 Cursors

- X Cursor**



X cursor is a vertical solid/dotted line that is used to make horizontal adjustments. It can be used to measure time (s) and frequency (Hz).

  - Cursor A is a vertical solid line (AX is displayed at the bottom of the screen), and Cursor B is a vertical dotted line (BX is displayed at the bottom of the screen).
  - In the XY cursor mode, X cursor is used to measure the waveform amplitude of Source X.
- Y Cursor**

Y cursor is a horizontal solid/dotted line that is used to make vertical adjustments. It can be used to measure amplitude (the unit is the same as that of the source channel amplitude).

- Cursor A is a horizontal solid line ( is displayed at the right section of the screen), and Cursor B is a horizontal dotted line ( is displayed at the right section of the screen).
- In XY cursor mode, Y cursor is used to measure the waveform amplitude of Source Y.

You can enable cursor measurements in the following ways.

- Click or tap the function navigation icon  > **Cursors** to enable cursor measurements.
- Click or tap the **Cursors** button on the toolbar to enable cursor measurements.
- Press the front-panel  key to enable cursor measurements.

The measurement results are displayed in the "Result" bar at the right side of the screen.



- AX: indicates the X value at Cursor A.
- AY: indicates the Y value at Cursor A.
- BX: indicates the X value at Cursor B.
- BY: indicates the Y value at Cursor B.
- ΔX: indicates the horizontal spacing between Cursor A and Cursor B.
- ΔY: indicates the vertical spacing between Cursor A and Cursor B.
- 1/ΔX: indicates the reciprocal of the horizontal spacing between Cursor A and Cursor B.

Click or tap the result bar and then select **Remove** or **Setting** in the pop-up window.

- Click or tap **Remove**. Then the current cursor measurement results will be cleared.
- Click or tap **Setting**. Then the "Cursors" menu is displayed. You can select the cursor mode: Manual, Track, and XY.

### 10.7.1 Manual Mode

In the manual cursor mode, you can adjust the cursor manually to measure the value of the waveforms of the specified source at the current cursor. If the settings for the parameter such as the cursor type and measurement source are different, the measurement results will be different for cursor measurement.

In the **Cursors** menu, click or tap **Manual** for the **Mode** item to enable the Manual cursor measurement function. The measurement results are displayed in the Result bar at the right side of the screen. When you change the cursor position, the measurement results will be changed accordingly.

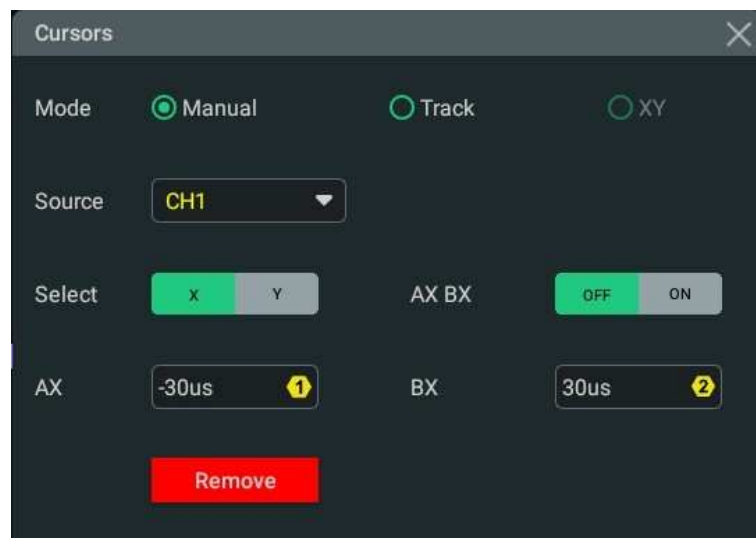

Figure 10.6 Manual Mode Setting Menu

#### Select the Measurement Source

Click or tap the drop-down button of **Source** to select the desired channel (None, Analog Channel CH1 to CH8 or Math1-Math4).

When a specified channel is selected as the source, it will be automatically turned on.

#### Select Cursor Type

Click or tap the **Select** toggle button to select "X" or "Y".

- **X**: It is a pair of vertical solid (Cursor A)/dotted (Cursor B) lines, used for measuring time parameters. The measurement results include AX, BX,  $\Delta X$ , and  $1/\Delta X$ .

- **Y:** It is a pair of horizontal solid (Cursor A)/dotted (Cursor B) lines, used for measuring voltage parameters. The measurement results include AY, BY, and  $\Delta Y$ .

### Adjust Cursor Position

1. When "X" is selected, you can adjust the position of X cursor.

- Click or tap the input field of **AX** and use the pop-up numeric keypad to set the horizontal position of Cursor A (X cursors). The horizontal axis indicates time, and the unit of its setting value is the same as that of the horizontal unit. Its adjustable range is limited within the screen.
- Click or tap the input field of **BX** and use the pop-up numeric keypad to set the horizontal position of Cursor B (X cursors). The horizontal axis indicates time, and the unit of its setting value is the same as that of the horizontal unit. Its adjustable range is limited within the screen.
- Click or tap the ON/OFF tab for **AX BX** to turn on/off adjusting the horizontal position of Cursor A and Cursor B (X cursors) simultaneously. The horizontal spacing between Cursor A and Cursor B (X cursors) remains unchanged.

2. When "Y" is selected, you can adjust the position of Y cursor.

- Click or tap the input field of **AY**, and then use the pop-up numeric keypad to set the vertical position of Cursor A (Y cursors). The vertical axis indicates voltage, and the unit of its setting value is the same as that of the vertical unit.
- Click or tap the input field of **BY** and use the pop-up numeric keypad to set the vertical position of Cursor B (Y cursor). The vertical axis indicates voltage, and the unit of its setting value is the same as that of the vertical unit.
- Click or tap the ON/OFF tab for **AY BY** to turn on/off adjusting the vertical position of Cursor A and Cursor B (Y cursors) simultaneously. The vertical spacing between Cursor A and Cursor B (Y cursors) remains unchanged.

You can also use the front-panel multifunction knob  to adjust the cursor position.

### Measurement Example

Measure the period of a sine wave by using the manual cursor measurement and auto measurement respectively. The measurement results are both 8  $\mu\text{s}$ .

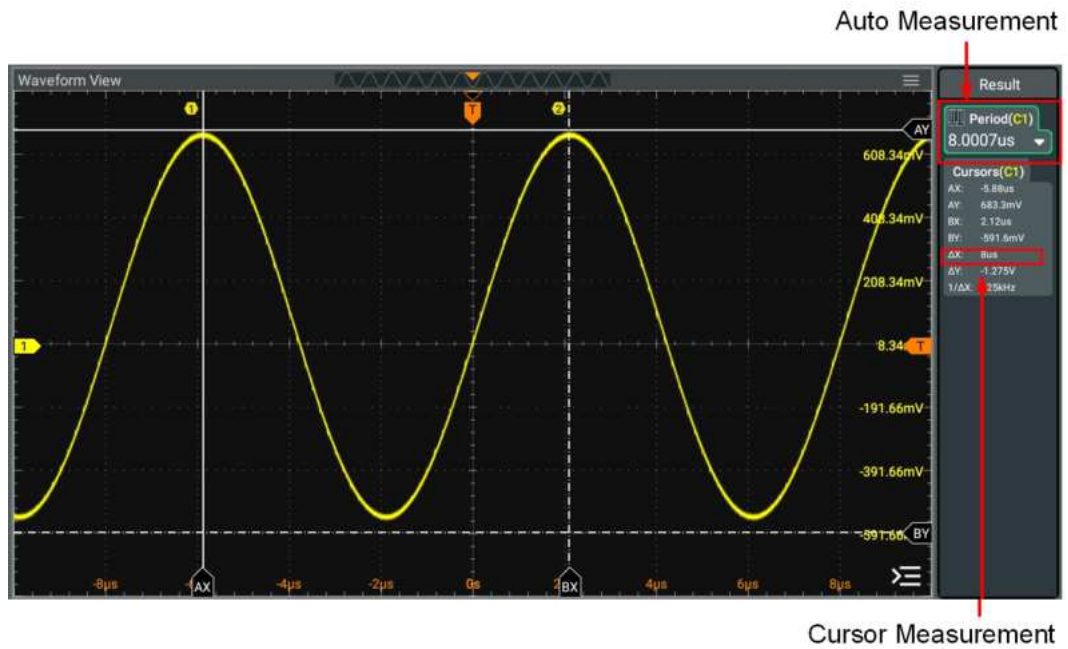
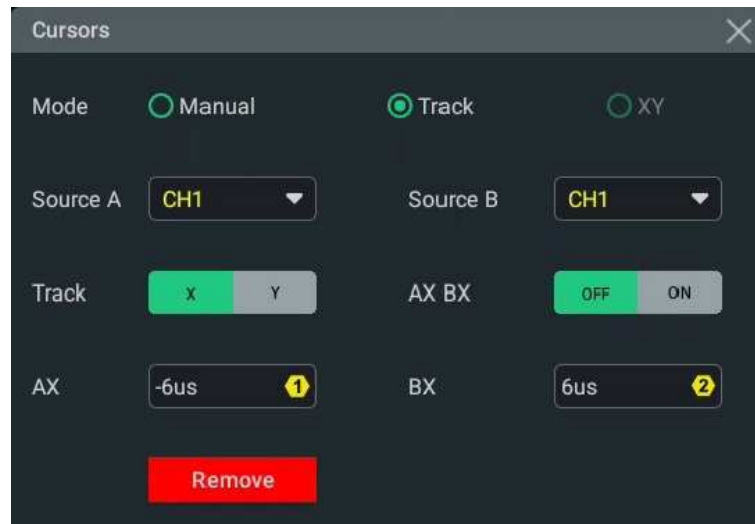

Figure 10.7 Manual Cursor Measurement Example

## 10.7.2 Track Mode

In the Track mode, you can adjust the two pairs of cursors (Cursor A and Cursor B) to measure the X and Y values on two different sources respectively. When the cursors are moved horizontally/vertically, the markers will position on the waveform automatically. When the waveform is expanded or compressed horizontally/vertically, the markers will track the points being marked at the last adjustment of the cursors.

In the **Cursors** menu, click or tap **Track** for the **Mode** item to enable the Track cursor measurement function. The measurement results are displayed in the "Result" bar at the right section of the screen.



**Figure 10.8 Track Mode Setting Menu**

#### Select the Measurement Source

- Click or tap the drop-down button of **Source A** to select the desired channel (None, Analog Channel CH1 to CH8, or Math1-Math4).
- Click or tap the drop-down button of **Source B** to select the desired channel (None, Analog Channel CH1 to CH8, or Math1-Math4).

When a specified channel is selected as the source, it will be automatically turned on.

#### Select the Track Mode

Click or tap the **Track** toggle button to select "X" or "Y" as the current track axis. By default, it is "X".

- **X:** When the X cursor position is adjusted, Y cursor will automatically track the intersection point between X cursor and source signal
- **Y:** When the Y cursor position is adjusted, X cursor will automatically track the intersection point between Y cursor and source signal.

#### Adjust Cursor Position

- When "X" is selected, you can adjust the position of X cursor.
  - Click or tap the input field of **AX** and use the pop-up numeric keypad to set the horizontal position of Cursor A (X cursor). Its adjustable range is limited within the screen.
  - Click or tap the input field of **BX** and use the pop-up numeric keypad to set the horizontal position of Cursor B (X cursors). Its adjustable range is limited within the screen.
  - Click or tap the ON/OFF tab for **AX BX** to turn on/off adjusting the horizontal position of Cursor A and Cursor B (X cursors) simultaneously. The

horizontal spacing between Cursor A and Cursor B (X cursors) remains unchanged.

- When "Y" is selected, you can adjust the position of Y cursor.
  - Click or tap the input field of **AY**, and then use the pop-up numeric keypad to set the vertical position of Cursor A (Y cursors).
  - Click or tap the input field of **BY** and use the pop-up numeric keypad to set the vertical position of Cursor B (Y cursor).
  - Click or tap the ON/OFF tab for **AY BY** to turn on/off adjusting the vertical position of Cursor A and Cursor B (Y cursors) simultaneously. The vertical spacing between Cursor A and Cursor B (Y cursors) remains unchanged.

You can also use the front-panel multifunction knob  to adjust the cursor position.

### Measurement Example

Set the **AX Source** to CH1, **BX Source** to CH2, and **Track** to "X".

When the AX cursor position is adjusted, AY cursor will automatically track the intersection point between AX cursor and source signal (CH1); When the BX cursor position is adjusted, BY cursor will automatically track the intersection point between BX cursor and source signal (CH2). The measurement results are displayed in the Result bar, as shown in *Figure 10.9*. Then, expand the waveforms horizontally, and you will find that the cursor will track the point that has been marked, as shown in *Figure 10.10*.



**Figure 10.9 Track Measurement (before Horizontal Expansion)**



Figure 10.10 Track Measurement (after Horizontal Expansion)

### 10.7.3 XY Mode

In the **Cursors** menu, click or tap **XY** for the **Mode** item to enable the XY cursor measurement function. The measurement results are displayed in the Result bar at the right side of the screen.

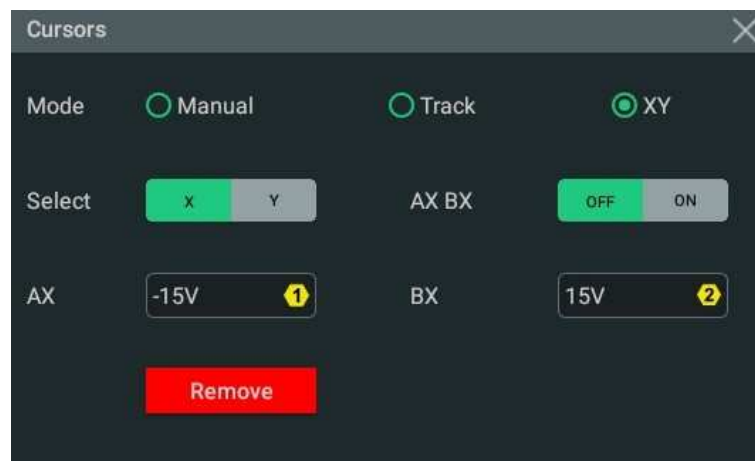

Figure 10.11 XY Mode Setting Menu



#### TIP

By default, XY mode is unavailable. It is available only when the horizontal time base mode is "XY". To enable the XY mode, please refer to *XY Mode*.

#### Adjust Cursor Position

- Click or tap to select the "X" tab under the **Select** menu item to set the X value for the specified cursor.
  - Click or tap the input field of **AX** and use the pop-up numeric keypad to set the X value at Cursor A.

- Click or tap the input field of **BX** and use the pop-up numeric keypad to set the X value at Cursor B.
- Click or tap the ON/OFF tab for **AX BX** to turn on/off adjusting the X value at Cursor A and the X value at Cursor B simultaneously.
- Click or tap to select "Y" under the **Select** item to set the Y value for the specified cursor.
  - Click or tap the input field of **AY** and use the pop-up numeric keypad to set the Y value at Cursor A.
  - Click or tap the input field of **BY** and use the pop-up numeric keypad to set the Y value at Cursor B.
  - Click or tap the ON/OFF tab for **AY BY** to turn on/off adjusting the Y value at Cursor A and the Y value at Cursor B simultaneously.



You can also use the front-panel multifunction knob  to adjust the cursor position.

# 11 Digital Voltmeter (DVM) and Frequency Counter

This series oscilloscope provides a built-in digital voltmeter (DVM) and frequency counter, which enable you to perform more accurate measurements, improving user experience in counter and frequency measurement.

## 11.1 Digital Voltmeter (DVM)

The built-in DVM of this series oscilloscope provides 4-digit voltage measurements on any analog channel. DVM measurements are asynchronous from the oscilloscope's acquisition system and are always acquiring. You can enable the DVM measurement in the following method:

- Click or tap the function navigation icon  > **DVM** to enable DVM measurements.
- Click or tap the **DVM** button on the toolbar to enable DVM measurements.
- Press the front-panel  key and then select **DVM** in the displayed "Analyse" menu to enable the DVM measurements.

After the DVM measurement is enabled, the "DVM" label displaying the current voltage value and voltage mode appears in the "Result" list at the right section of the screen, as shown in the figure below.

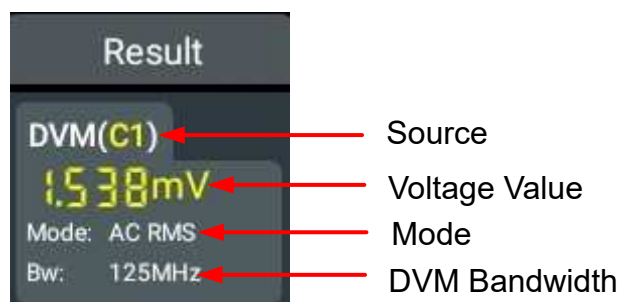

The voltage value above shows the measurement extrema over the last 3 seconds.

Click or tap the "DVM" label and then a window is displayed. Click or tap **Setting** to enter the DVM setting menu. Click or tap **Remove** to remove the DVM measurement results and exit the DVM measurement.

### 11.1.1 Measurement Settings

After the DVM measurement is enabled, the DVM result list is displayed at the right section of the screen. Click or tap the result list, the sub-menus are displayed. Click or tap **Setting** to enter the DVM setting menu.

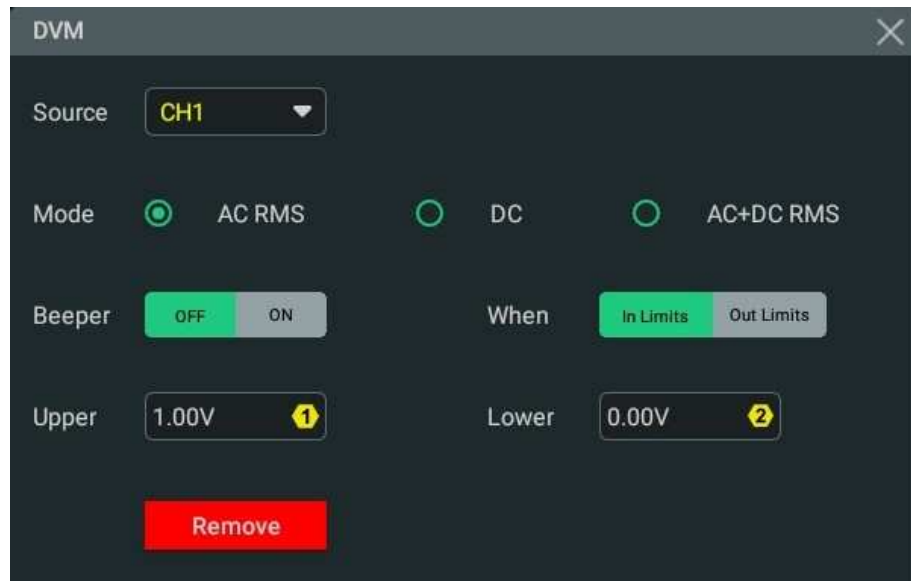

Figure 11.1 DVM Setting Menu

### Select the Measurement Source

Click or tap the drop-down button of **Source** to select the desired source from the drop-down list. The analog channel (CH1 to CH8) can be selected to be the measurement source.

Even if the analog channel (CH1 to CH8) is not enabled, you can still perform the DVM measurement.

### Select the Measurement Mode

In the **Mode** item, you can select the DVM mode. The DVM measurement modes include AC RMS, DC, and AC+DC RMS.

- AC RMS: displays the root-mean-square value of the acquired data, with the DC component removed.
- DC: displays the average value of the acquired data.
- AC+DC RMS: displays the root-mean-square value of the acquired data.

### Set the Limits

Click or tap the ON/OFF tab for **Beeper** to enable or disable the beeper. When enabled, you can set when ("In Limits" or "Out Limits") to sound an alarm.

- Limits Condition Setting

Click or tap to select "In Limits" or "Out Limits" under **When**.

- In Limits: when the voltage value is inside the limited range, you can enable or disable the beeper to sound an alarm.

- Out Limits: when the voltage value is outside the limited range, you can enable or disable the beeper to sound an alarm.
- Upper/Lower Limit Setting
 

Click or tap the input field of **Upper**, then use the pop-up numeric keypad to set the upper limit of the voltage or use the specified multifunction knob to set the value.

Click or tap the input field of **Lower**, and then use the pop-up numeric keypad to set the lower limit of the voltage or use the specified multifunction knob to set the value.

The available range of the upper limit is from 1 nV to 500 V. By default, it is 1 V. The available range of the lower limit is from -500 V to 990.00 mV. By default, it is 0 V.



### 11.1.2 To Remove the Measurement

Click or tap the DVM label in the result list, then the sub-menus are displayed. Click or tap **Remove** to remove the measurement results and exit the DVM measurement. You can also click or tap **Remove** in the DVM setting menu to remove the measurement results.

## 11.2 Frequency Counter

The frequency counter analysis function provides frequency, period, or edge event counter measurements on any analog channel.

You can enable the counter in the following ways:

- Click or tap  > **Counter** to enable the counter.
- Click or tap the **Counter** button on the toolbar to enable the counter.
- Press the front-panel  key and then select **Counter** in the displayed "Analyse" menu to enable the counter.

After the counter is enabled, the "Counter" label displaying the counter measurement results appears in the "Result" bar at the right section of the screen, as shown in the figure below.

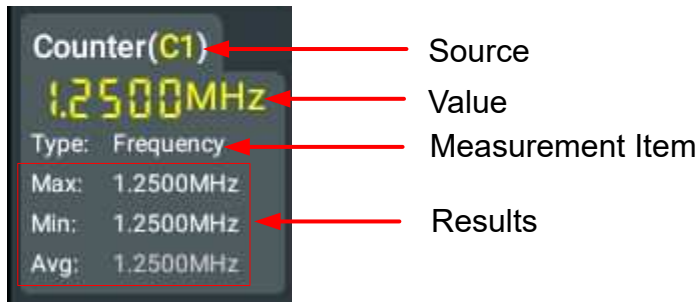

You can click or tap the "Counter" label in the "Result" bar and select **Reset Stat**, **Setting**, or **Remove** in the displayed window.

## 11.2.1 Measurement Settings

After the frequency counter is enabled, the frequency counter result list is displayed at the right section of the screen. Click or tap the result list, and then select **Setting**. Then the frequency counter interface is displayed.

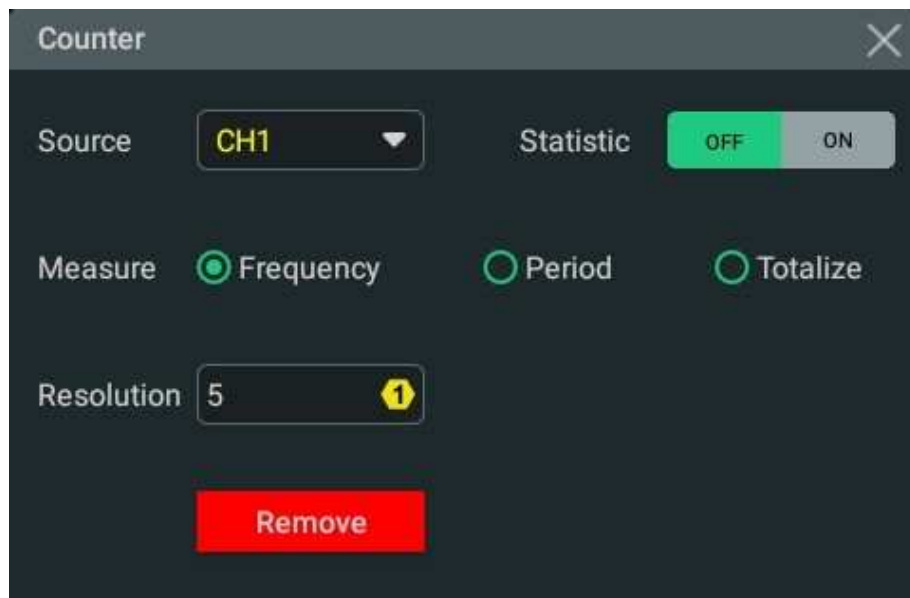

Figure 11.2 Frequency Counter Setting Menu

### Select the Measurement Source

Click or tap the drop-down button of **Source** to select the desired source from the drop-down list. Analog channels, digital channels, and EXT can all be selected as the source of the frequency counter.

### NOTE

For the channel sources supported by different models, refer to *Content Conventions in this Manual*



### Select the Measurement Item

In the **Measure** item, you can select the desired measurement item. Available options include Frequency, Period, and Totalize. Wherein, Totalize indicates the count of edge events on the signal.

### Set Resolution

For Period and Frequency measurements, you need to set the readout resolution. Click or tap the input field of **Resolution** to set the resolution by using the pop-up numeric keypad. You can also use the corresponding multifunction knob to set the value. The range of resolution is from 3 bits to 6 bits. By default, it is 4 bits.

The greater the resolution, the longer the gate time. In this way, the measurement time will be longer.

### Clear Count

When "Totalize" is selected as the measurement item, the oscilloscope measures the count of edge events on the signal. At this time, click or tap **Clear Count** to clear the measurement results and start the measurements again.

### Disable the Frequency Counter

After completing the measurement, click or tap **Remove** in the frequency counter setting interface to disable the frequency counter. All the frequency counter menu and statistics results are closed.

You can also click or tap the result list, then click or tap **Remove** from the displayed sub-menus to clear the measurement result. The frequency counter result list disappears.

## 11.2.2 To Reset Statistics

### Statistics Results

In the Counter setting menu, click or tap the ON/OFF tab for **Statistic** to enable or disable the display of the counter statistics. When enabled, all the statistical results will be displayed in the "Counter" result list.

### Reset Statistics

Click or tap **Reset Stat.** in the Counter setting interface to reset the statistics of the counter measurement results. You can also click or tap the Counter result list first. Then the sub-menus are displayed. Click or tap **Reset Stat.** to reset the statistics of the counter measurement results.

## 12 Digital Channels (Available Only for MHO Series)

Only the MHO series oscilloscope provides the standard configuration of the logic analyzer (LA) function. The MHO series has 16 digital channels, with D3-D0 as one group, D7-D4 as one group, D11-D8 as one group, D15-D12 as one group.

The oscilloscope compares the voltages acquired in each sample with the preset logic threshold. If the voltage of the sample point is greater than the threshold, it will be stored as logic 1; otherwise, it will be stored as logic 0. The oscilloscope displays logic levels ("1" and "0") in the form of a graph for you to easily detect and analyze the errors in circuit design (hardware design and software design).

To enter Logic Analyzer (LA) menu, perform one of the following operations:

- Press  on the front panel to enter the LA menu.
- Click or tap the "L" label at the bottom of the screen to enter the logic analyzer (LA) menu.

Before using the digital channels, connect the PLA3204 active logic analyzer probe (option, required to purchase by yourself) to the oscilloscope and the device under test (DUT). For details about how to use the PLA3204 probe, refer to *PLA3204 Active Logic Probe User Guide*.

### 12.1 Basic Settings

In the **Basic Settings** tab, you can enable or disable the specified digital channel, set the channel label, and set the threshold for the channel.

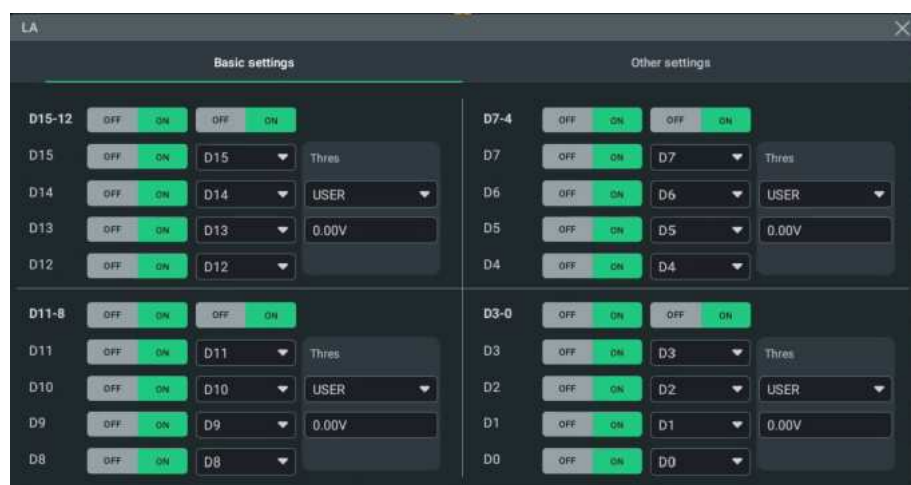
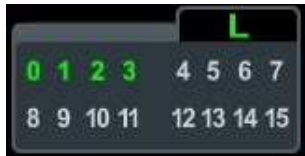

Figure 12.1 Basic Settings Tab of Logic Analyzer Interface

## 12.1.1 To Enable or Disable the Digital Channel

The LA function allows you to enable or disable all the channels of the specified group; enable or disable each single digital channel. The digital channel label at the bottom of the screen displays the on/off status of the digital channel. The channels indicated in gray are disabled and those indicated in green are enabled.



### Enable or Disable a Single Channel

You can click or tap the **ON/OFF** tab following the specified digital channel to enable or disable any of the 15 digital channels (D0 ~ D15).

#### TIP

When the specified group of digital channels is enabled or disabled, you can still set the on/off status independently for the specified channel in this group.

### Enable or Disable the Channels of a Specified Group

In the LA interface, you can enable or disable all the digital channels in the specified group with the global on/off tab for the specified group (**D15-D12**, **D11-D8**, **D7-D4**, or **D3-D0**).

### On/Off Control of All Channels

When some digital channels have been enabled and you want to disable all the enabled channels, click to drag the digital channel label downward. You can also drag it downward on the touch screen to disable all the enabled digital channels.

## 12.1.2 To Set the Label

By default, the instrument takes D0-D15 as the channel label of the 16 digital channels. You can set a user-defined label for each digital channel to differentiate the channel and their input signal.

### Enable or Disable the Label Display

Click or tap the ON/OFF tab for the channel label to display or hide the channel label of the specified group channel. If enabled, the labels of the specified channel group will be displayed at the leftmost side of the waveform view.

### Use Preset Labels

This oscilloscope presets the common signal type names for the channel label, including ACK, ADO, ADDR, BIT, CAS, CLK, and DATA.

Click or tap the drop-down button of the specified channel label name to select the preset channel label for the channel.

#### Set the User-defined Label

To set a user-defined label for the channel, click or tap the drop-down button of User, then you can use the pop-up numeric keypad to set the channel label.

### 12.1.3 To Select the Digital Channel

When the digital channels are enabled, click or tap the digital channel label or the channel waveforms on the screen to select the specified channel. By default, the waveforms of the digital channels are displayed in green. When you click or tap the specified channel label or waveform of the specified channel, the selected waveform of the channel is displayed in red.



#### TIP

Only the enabled digital channels can be selected.

### 12.1.4 To Set the Threshold

The MHO series oscilloscope allows you to set the threshold for each group of digital channels. The threshold levels for the four groups (D15-D12, D11-D8, D7-D4, and D3-D0) of digital channels are set independently. When the voltage of the input signal is greater than the currently set threshold, it is treated as logic 1; otherwise, it is treated as logic 0.

#### Use the Preset Threshold

To facilitate operation, the system has preset the threshold for the common signals, including TTL(1.4 V), CMOS5.0(2.5 V), CMOS3.3(1.65 V), CMOS2.5(1.25 V), CMOS1.8(0.9 V), ECL(-1.3 V), PECL(3.7 V), and LVDS(1.2 V).

Click or tap the drop-down button of **Thres** to select the desired preset threshold for the channel group.

#### Set the User-defined Threshold

To set a user-defined threshold for the channel, click or tap the drop-down button of **Thres** to select "User". Then set the threshold with the pop-up numeric keypad. The range of the threshold is from -15 V to 15 V.

## 12.2 Other Settings

In the **Other settings** tab, you can set the waveform size of the digital channels, the channel sequence, probe delay, and probe calibration.

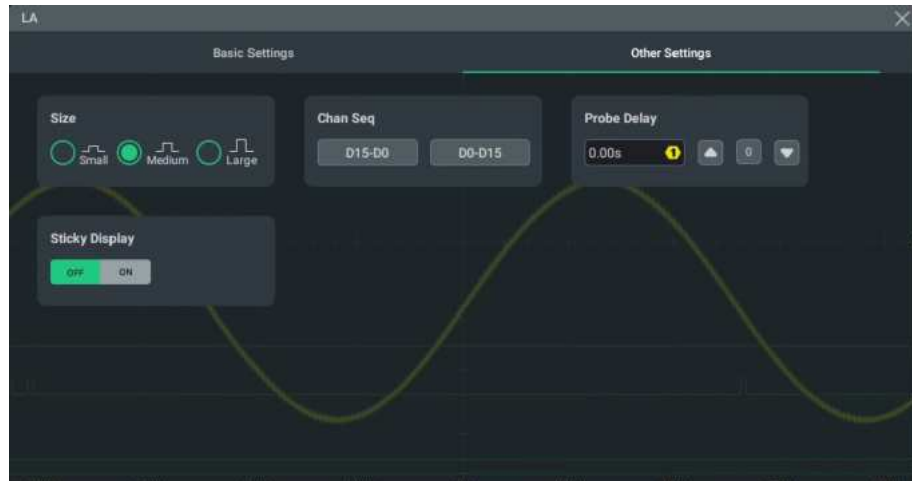

Figure 12.2 Other Settings Tab of Logic Analyzer Interface

### 12.2.1 To Set the Waveform Size

This series oscilloscope allows you to set the waveform size for the digital channels. If you need to observe several waveforms of the digital channels, you can set the waveform size to small, medium, and large to make them easy to observe.



#### TIP

"Large" is only available when the number of currently enabled digital channels is less than or equal to 8.

### 12.2.2 To Set the Channel Sequence

You can set the waveform sequence for the enabled channels according to your needs.

- D0-D15: the waveforms of channels (D0 to D15) are displayed on the screen in sequence from top to bottom in the waveform view.
- D15-D0: the waveforms of channels (D15 to D0) are displayed on the screen in sequence from top to bottom in the waveform view.

You can also drag the waveform of the specified digital channel to a specified position to adjust the channel waveform sequence.

### 12.2.3 Sticky Display of the Waveform

When the waveform of the digital channel and that of the analog channel are overlapped, you can enable sticky display to sticky the preferred waveforms to the top position.

- When set to OFF, the waveform of the analog channel is displayed at the top.

- When set to ON, the waveform of the digital channel is displayed at the top.

## 12.2.4 To Set the Probe Delay

To avoid measurement result errors arising from the transmission delay of the probe cable, you can set the probe delay on the oscilloscope.

In the LA interface, click or tap the **Other Settings** tab to enter the other settings interface. Click or tap the input field of **Probe Delay** to set the probe delay with the pop-up numeric keypad. Its range is from -200 ns to 200 ns. By default, it is set to 0 s. You can also use the Up/Down arrow to adjust the probe delay. Also, if no probe delay is required, you can directly click or tap 0 to reset it to zero.

## 13 Histogram Analysis

The histogram analysis function provides you a statistical view of the waveforms or measurement results, enabling you to judge the trend of waveforms, and quickly locate the potential problems of the signal. This series oscilloscope supports horizontal histogram, vertical histogram and and measurement histogram.

Click or tap the function navigation icon  at the lower-left corner of the screen, and then select **Histogram** to enter the histogram setting menu.

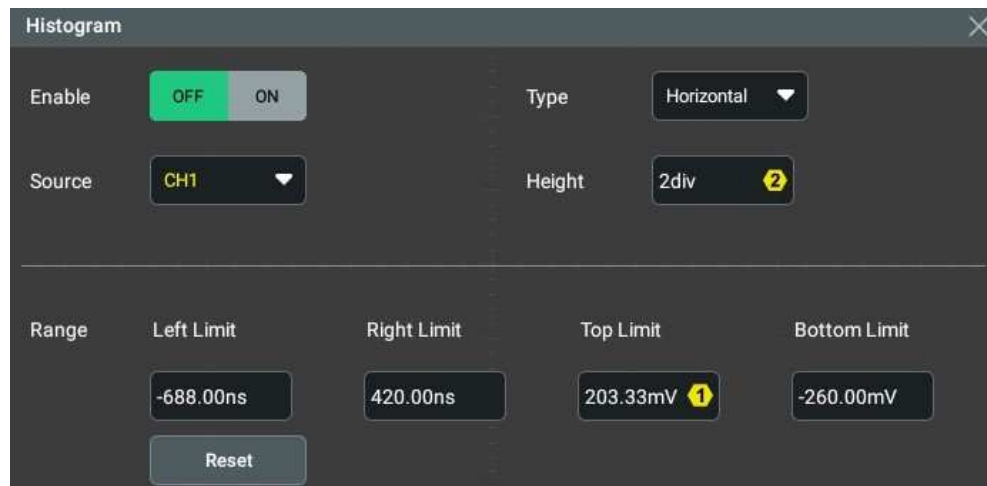

Figure 13.1 Histogram Setting Menu

### 13.1 To Enable or Disable the Histogram

In the "Histogram" setting menu, click or tap the ON/OFF tab for **Enable** to enable or disable the histogram analysis function. When enabled, with the on-going acquisition and measurement of the waveforms, the height of the bar graph of the histogram will change within the set range of the histogram window to indicate the number of times for data statistics.

Here takes the horizontal histogram as an example. When enabled, the histogram is displayed on the screen as shown in the figure below. The histogram result is displayed in the "Result" list at the right section of the screen.

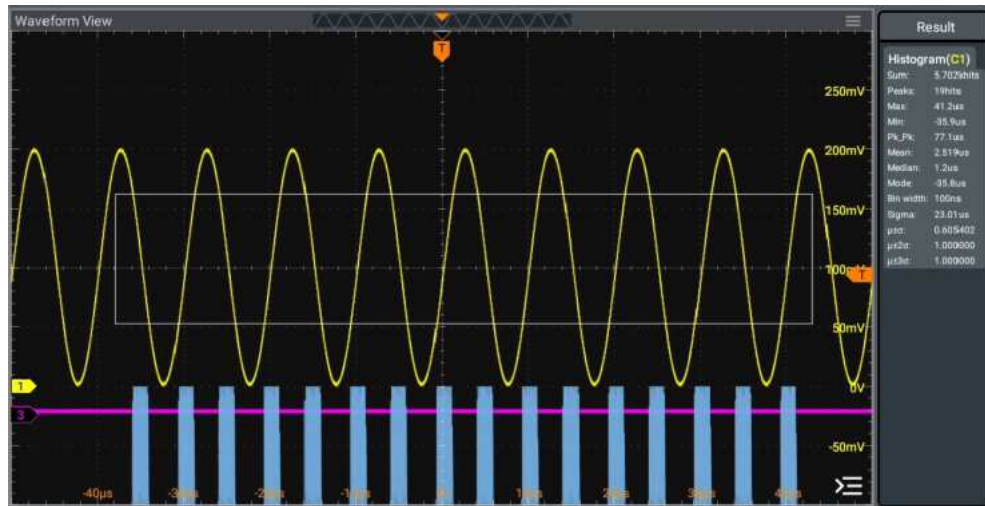

Figure 13.2 Histogram Analysis Interface

When the histogram is enabled, click or tap the histogram result list, the sub-menus of histogram are displayed. Click or tap **Setting** to enter the histogram setting interface.

#### TIP

For the definitions of the measurement items in the histogram result, refer to *Histogram Analysis Results*.

## 13.2 To Select the Histogram Type

In the "Histogram" setting menu, click or tap the drop-down button of **Type** to select the histogram type from the drop-down list.

- Horizontal: displays the number of times for statistics making in the forms of columns in the histogram bar graph at the bottom of the graticule.
- Vertical: displays the number of times for statistics making in the forms of rows in the histogram bar graph at the left of the graticule.

## 13.3 To Select the Histogram Source

In the "Histogram" setting menu, click or tap the drop-down button of **Source** to select the desired source from the drop-down list. All the analog channels can be selected to be the Histogram source.

For the channel sources supported by different models, refer to *Content Conventions in this Manual*.

## 13.4 To Set the Histogram Height

The histogram height indicates the number of grids the histogram bar graph should use on the screen.

In the histogram setting interface, click or tap the input field of **Height** to set the the height of the histogram with the pop-up numeric keypad.. The range of the histogram height is from 1 div to 4 div. By default, it is 2 div.

## 13.5 To Set the Histogram Range

When the histogram type is set to Vertical or Horizontal, you need to sets the histogram range. Set "Left Limit", "Right Limit", "Top Limit", and "Bottom Limit" respectively to adjust the size and position of the histogram.

Click or tap the input field of the specified limit to set the specified limit of the histogram with the pop-up numeric keypad. You can also use the specified knob indicated in the input field to set it. You also directly drag the left, right, top, or bottom edge of the white histogram diagram window to adjust the position and size the histogram.

### NOTE

The adjustment for the horizontal time base and vertical scale will not affect the histogram range, but only shows variation with the change of the scale.



## 13.6 Histogram Analysis Results

When the histogram function is enabled, the histogram result is displayed in the "Result" list at the right section of the screen. The test result includes the following test items:

- Sum: indicates the sum of all bins (buckets) in the histogram.
- Peaks: indicates the maximum number of hits in any single bin.
- Max: indicates the value that corresponds to the maximum bin that has any hits.
- Min: indicates the value that corresponds to the minimum bin that has any hits.
- Pk\_Pk: indicates the Delta between the max. value and the min. value.
- Mean: indicates the average value of the histogram.
- Median: indicates the median value of the histogram.
- Mode: indicates the mode value of the histogram.
- Bin width: indicates the width of each bin (bucket) in the histogram.
- Sigma: indicates the standard deviation of the histogram.
- $\mu \pm \sigma$ : indicates the proportion of the number of frequencies or counts of the histogram hits that lie within one standard deviation of the mean to the total number of histogram hits.  $\mu$  indicates the mean value in normal distribution. It is

the average of the numbers.  $\sigma$  indicates the standard deviation in the normal distribution.

- $\mu \pm 2\sigma$ : indicates the proportion of the number of frequencies or counts of the histogram hits that lie within two standard deviations of the mean to the total number of histogram hits.  $\mu$  indicates the mean value in normal distribution. It is the average of the numbers.  $\sigma$  indicates the standard deviation in the normal distribution.
- $\mu \pm 3\sigma$ : indicates the proportion of the number of frequencies or counts of the histogram hits that lie within three standard deviations of the mean to the total number of histogram hits.  $\mu$  indicates the mean value in normal distribution. It is the average of the numbers.  $\sigma$  indicates the standard deviation in the normal distribution.

## 13.7 To Remove the Measurement

---

- Click or tap the histogram result list, then the sub-menus of the histogram function are displayed. Click or tap **Remove** to remove the measurement results and close the histogram result list and exit the histogram function.
- Click and drag the result list to the right to remove the measurement results and exit the histogram function.

## 13.8 To Clear Statistics

---

Click or tap the histogram result list, then the sub-menus of the histogram function are displayed. Click or tap **Clear** to clear the statistics.

## 14 Function/Arbitrary Waveform Generator (Available Only for MHO5054/5104)

With an optional configuration of built-in dual-channel, 50 MHz Function/Arbitrary Waveform Generator, the MHO5054 and MHO5104 series integrates the Function/Arbitrary Waveform Generator and the oscilloscope into one, thus providing great convenience for engineers who need to use the Function/Arbitrary Waveform Generator and oscilloscope at the same time. This chapter introduces how to use the built-in Function/Arbitrary Waveform Generator option.

To enable the AFG function, perform any of the following operations:

- Press **GI** or **GII** on the front panel to enable GI or GII, then enter the specified setting interface.
- Click or tap the GI or GII label at the bottom of the screen to enter the specified AFG setting interface.

The on/off status of the specified AFG channel is indicated in its label color. When enabled, the label is highlighted in orange, with output waveform information on it. When disabled, the label is gray out.

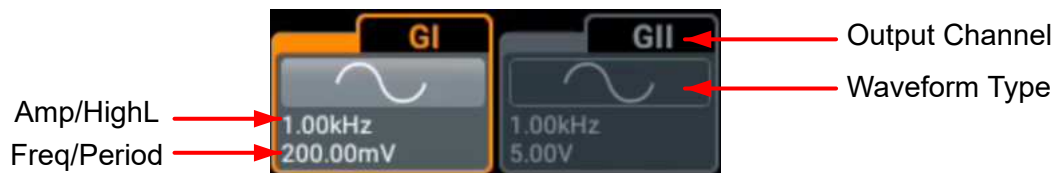

To disable the AFG function, press **GI** or **GII** on the front panel to disable GI or GII. You can also click or tap the enabled GI or GII label at the bottom of the screen to exit the specified AFG interface. Also, you can drag the label downward to disable the enabled AFG channel and exit the specified AFG interface.

## 14.1 To Output Basic Waveforms

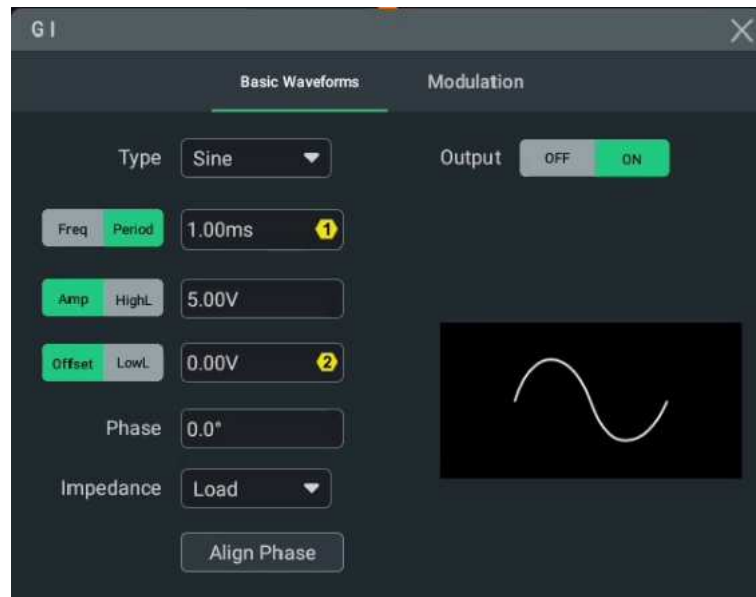

Figure 14.1 AFG Menu

The front-panel G1 and GII can output different waveform types at the same time. You can set parameters for G1 and GII output channels respectively.

The built-in AFG (G1 and GII) can output various types of waveforms.

- Standard waveforms: Sine, Square, Ramp, and Noise
- Built-in waveforms: DC, Sinc, Exp.Rise, Exp.Fall, ECG1, Gauss, Lorentz, and Haversine

After completing the waveform parameter settings, set **Output** to "ON". The waveforms set in the AFG interface can be output from the specified front-panel AFG channel (G1 or GII).

### 14.1.1 Sine

In the Basic Waveforms tab, click or tap the drop-down button of **Type** to select "Sine". Then you can set the Sine parameters. At this time, you can set the parameters for the Sine waveform.

#### Set the Frequency/Period

Click or tap the input field of **Freq/Period** to set the frequency or period of the current Sine signal with the pop-up numeric keypad. You can also use the specified knob indicated in the field to set it. Different waveforms have different frequency or period (reciprocal of the frequency) ranges.

- Sine: 1  $\mu$ Hz to 50 MHz
- Square/Pulse: 1  $\mu$ Hz to 30 MHz
- Ramp: 1  $\mu$ Hz to 2 MHz
- DC and Noise: no frequency parameter.

### Set the Amplitude

Click or tap the input field of **Amp** to set the amplitude of the current Sine signal with the pop-up numeric keypad. You can also use the specified knob indicated in the field to set it. The amplitude range of the Sine waveform is as follows:

- 2 mVpp to 10 Vpp (1 M $\Omega$ )
- 1 mVpp to 5 Vpp (50  $\Omega$ )

### Set the Offset

Click or tap the input field of **Offset** to set the offset of the current Sine signal with the pop-up numeric keypad. You can also use the specified knob indicated in the field to set it. The offset range is from 1 nV to 1  $\mu$ V.

- -9 V to 9 V (1 M $\Omega$ )
- -4.5 V to 4.5 V (50  $\Omega$ )

### Set the High/Low Level

In the amplitude and offset setting of the output waveform, you can also click or tap to select **HighL** or **LowL** to set the high level and low level of the output waveforms.

- Amplitude = (High Level - Low Level)/2
- Offset = (High Level + Low Level)/2

The available range of high level is from -2.5 V to +10 V. By default, it is 1 V. The available range of low level is from -10 V to +2.5 V. By default, it is -1 V.

### Set the Start Phase

Click or tap the input field of **Phase** to set the start phase with the pop-up numeric keypad. You can also use the specified knob indicated in the field to set it. The available range of start phase is from 0° to 360°. By default, it is 0°.

### Align Phase

Click or tap **Align Phase** to re-configure the two channels to output according to the set frequency and phase. If these two signals whose frequencies are identical or in multiple, you can click or tap this menu to align their phases.

Use the oscilloscope to acquire the waveforms of the two channels and stably display the waveforms. After switching the channel status, the phase deviation between the

(Available Only for MHO5054/5104)

two waveforms is changed. At this time, click or tap **Align Phase**, then the phase deviation shown on the oscilloscope will restore to the current phase deviation between the two waveforms automatically.

## 14.1.2 Square

In the Basic Waveforms tab, click or tap the drop-down button of **Type** to select "Square". Then you can set the Square parameters. At this time, you can set the parameters for the Square waveform.

Refer to *Sine* to set the frequency, phase, amplitude, and offset parameters. This section will only elaborate on how to set the duty cycle.

### Set the Duty Cycle

Duty cycle is defined as the percentage that the high level takes up in the whole period, as shown in the figure below. This parameter is only available when Square is selected.

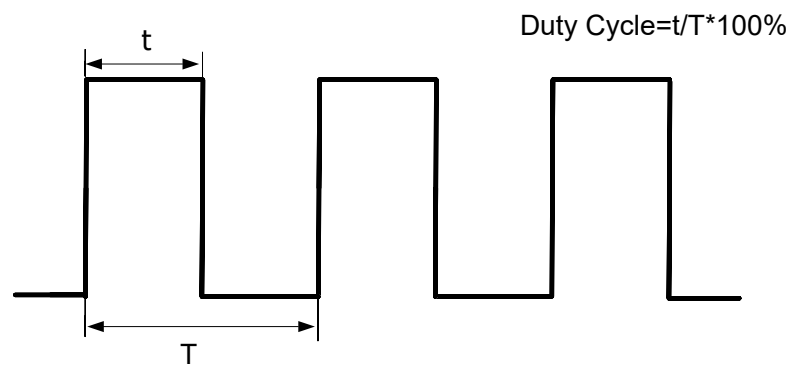

Click or tap the of input field of **Duty** to set the duty cycle with the pop-up numeric keypad. You can also use the specified knob indicated in the field to set it. The available range of duty cycle is from 1% to 99%. By default, it is 50%.

## 14.1.3 Ramp

In the Basic Waveforms tab, click or tap the drop-down button of **Type** to select "Ramp". Then you can set the Ramp parameters. At this time, you can set the parameters for the ramp waveform.

Refer to *Sine* to set the frequency, phase, amplitude, and offset parameters. This section will only elaborate on how to set the symmetry.

### Symmetry

Symmetry is defined as the percentage of the amount of time Ramp wave is rising in the period, as shown in the figure below. This parameter is only available when Ramp is selected.

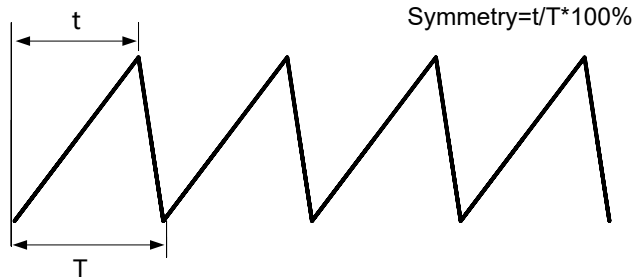

Click or tap the of input field of **Symm** to set the symmetry with the pop-up numeric keypad. You can also use the specified knob indicated in the field to set it. The available range of symmetry is from 0.1% to 99.9%. By default, it is 50%.

#### 14.1.4 Pulse

In the Basic Waveforms tab, click or tap the drop-down button of **Type** to select "Pulse". Then you can set the Pulse parameters. Refer to *Sine* to set the frequency, phase, amplitude, and offset parameters. For the duty cycle, refer to descriptions in *Square*. This section only elaborates on how to set the rising edge and falling edge.

The rising edge time is defined as the duration of the pulse amplitude rising from 10% to 90% threshold, while falling edge time is defined as the duration of the pulse amplitude moving down from 90% to 10% threshold.

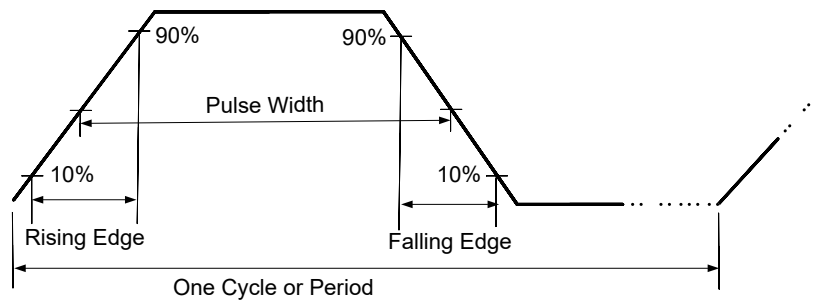

Click or tap the input field of **Rise Edge** to set the pulse rising edge time. Click or tap the input field of **Fall Edge** to set the pulse falling edge time with the pop-up numeric keypad. You also use the specified knob indicated in the input field to set the rising and falling edge time. The rising/falling edge time ranges from 1 ps to 1 s. By default, it is 300 ps.

#### 14.1.5 Noise

In the Basic Waveforms tab, click or tap the drop-down button of **Type** to select "Noise". Then you can set Noise parameters.

You can click or tap **Amp** to set the amplitude of Noise waveform. Its available range is from 2 mV to 2 V. Click or tap **Offset** to set the offset of the Noise waveform. The range of the offset is related to its amplitude value.

(Available Only for MHO5054/5104)

You can also click or tap to switch to the **HighL** and **LowL** tab to set the high level and low level of the Noise waveform. For details, refer to descriptions in *Sine*.

### 14.1.6 DC

In the Basic Waveforms tab, click or tap the drop-down button of **Type** to select "DC". Then you can set the DC parameters.

Click or tap the input field of **Offset** to set the offset of the DC signal with the pop-up numeric keypad. You can also use the specified knob indicated in the field to set it. The available range of offset is from -10 V to 10 V.

### 14.1.7 Exp.Rise

The Exp.Rise waveform is as shown in the figure below

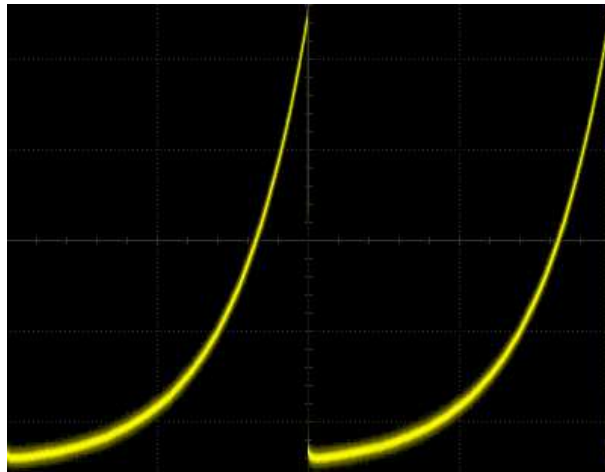

Figure 14.2 Exp.Rise

In the Basic Waveforms tab, click or tap the drop-down button of **Type** to select "Exp.Rise". Then set the Exp.Rise parameters. For setting methods, refer to descriptions in "*Sine*".

### 14.1.8 Exp.Fall

The Exp.Fall waveform is as shown in the figure below.

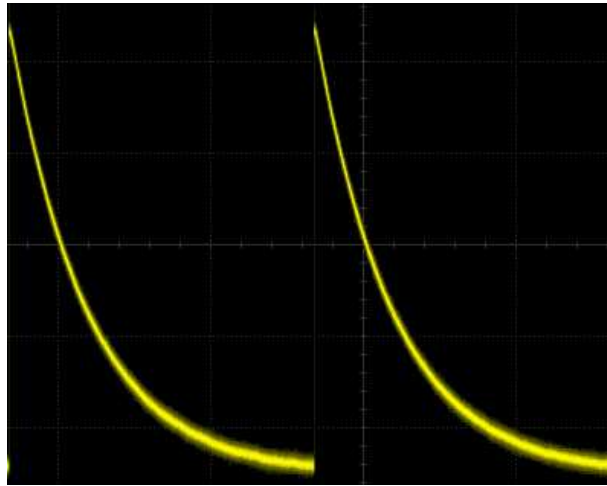

Figure 14.3 Exp.Fall

In the Basic Waveforms tab, click or tap the drop-down button of **Type** to select "Exp.Fall". Then set the Exp.Fall parameters. For setting methods, refer to descriptions in "*Sine*".

### 14.1.9 ECG1

The ECG1 waveform is as shown in the figure below

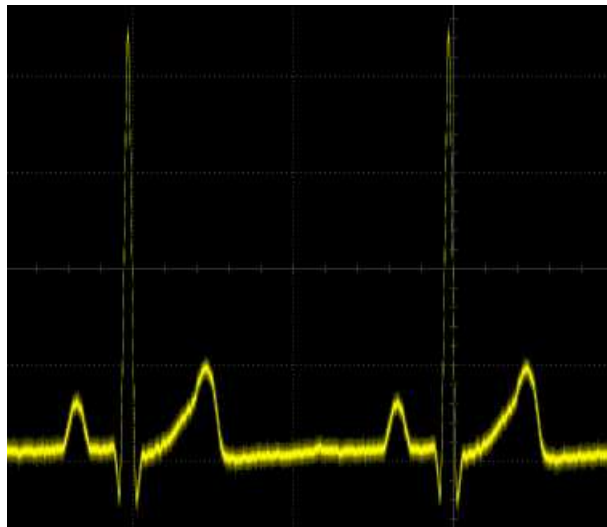

Figure 14.4 ECG1

In the Basic Waveforms tab, click or tap the drop-down button of **Type** to select "ECG1". Then set the ECG1 parameters. For setting methods, refer to descriptions in "*Sine*".

### 14.1.10 Gauss

The Gauss waveform is as shown in the figure below:

(Available Only for MHO5054/5104)

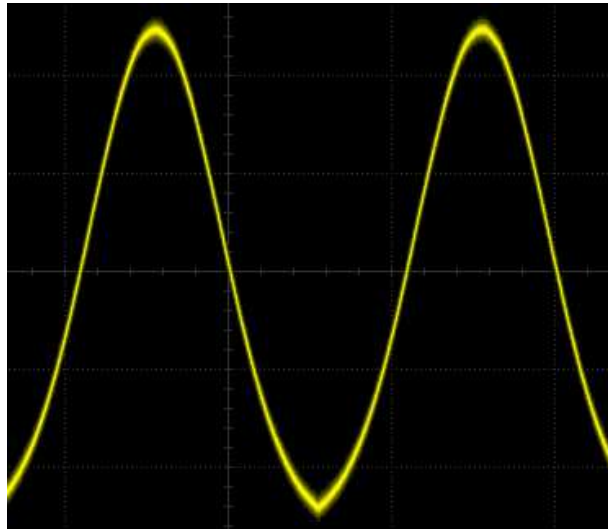
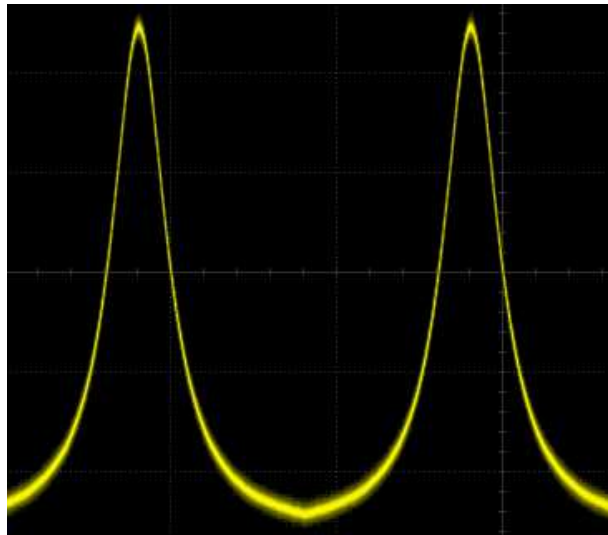

**Figure 14.5 Gauss**

In the Basic Waveforms tab, click or tap the drop-down button of **Type** to select "Gauss". Then set the Gauss parameters. For detailed setting methods, refer to descriptions in *Sine*.

### 14.1.11 Lorentz

The Lorentz waveform is as shown in the figure below:



**Figure 14.6 Lorentz**

In the Basic Waveforms tab, click or tap the drop-down button of **Type** to select "Lorentz". Then set the Lorentz parameters. For detailed setting methods, refer to descriptions in *Sine*.

### 14.1.12 Haversine

The Haversine waveform is as shown in the figure below:

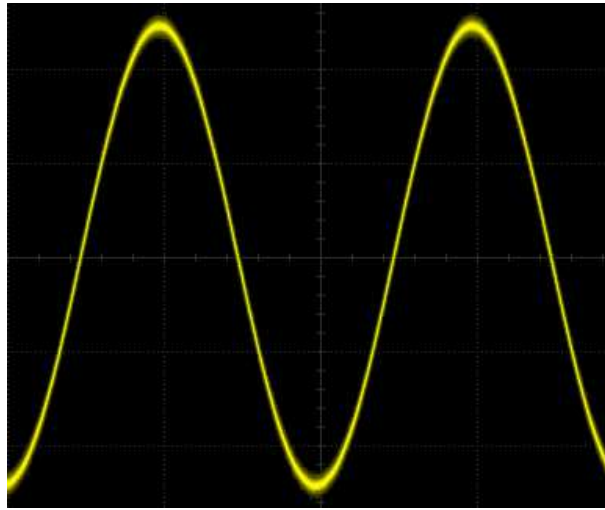

Figure 14.7 Haversine

In the Basic Waveforms tab, click or tap the drop-down button of **Type** to select "Haversine". Then set the Haversine parameters. For detailed setting methods, refer to descriptions in *Sine*.

### 14.1.13 Sinc

The Sinc waveform is as shown in the figure below

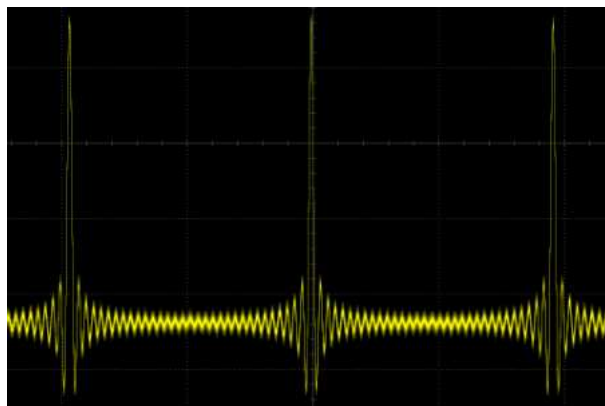

Figure 14.8 Sinc

In the Basic Waveforms tab, click or tap the drop-down button of **Type** to select "Sinc". Then set the Sinc parameters. For setting methods, refer to descriptions in *Sine*.

## 14.2 Modulation

Modulation is a process of converting analog or digital signals into high-frequency signals that are suitable for transmission. We called the original signal as the modulating waveform; the high-frequency signal used to carry the modulating signal is called the carrier waveform.

The MHO/DHO5000 series oscilloscope is equipped with the function/arbitrary waveform generator as the standard or optional configuration. The AFG function supports AM, FM, and PM modulation types. The modulating signal is the built-in waveform of AFG; the carrier waveform signal is the basic waveform output by the AFG.

In the AFG interface (G1 or G2), click or tap the **Modulation** tab to enter the modulation setting menu.

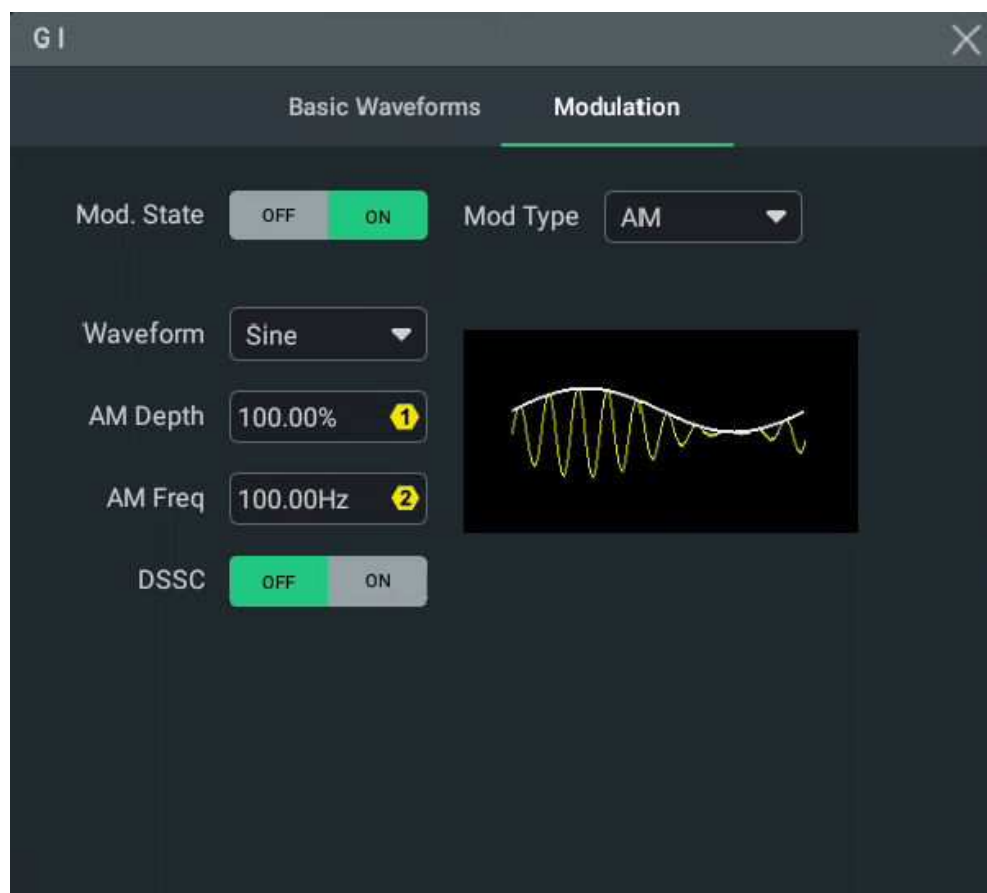

**Figure 14.9 Modulation Setting Interface**

Please configure the modulation settings according to the following procedures.

1. In the Basic Waveforms tab, click or tap **ON** to enable the output for the specified channel.

2. Click or tap the drop-down button of **Type** to select the desired waveform type. Then configure the parameter settings for the selected waveform type. For details of the parameter configurations, refer to *To Output Basic Waveforms*. The DC, Noise, and Pulse waveforms are not supported as carrier waveforms. If you select those waveforms that are not supported as the carrier waveforms, the modulation function is unavailable.
3. Click or tap the drop-down button of **Mod Type** to select the desired modulation type. Then configure the parameter settings for the selected modulation type.
4. Set the **Mod. State** to "ON". The modulated signal can be output from the specified front-panel AFG channel (G1 or G2).

The following section introduces the three modulation types.

### 14.2.1 AM

AM (Amplitude Modulation), namely the amplitude of the carrier waveform changes with that of the modulating waveform, as shown in the figure below.

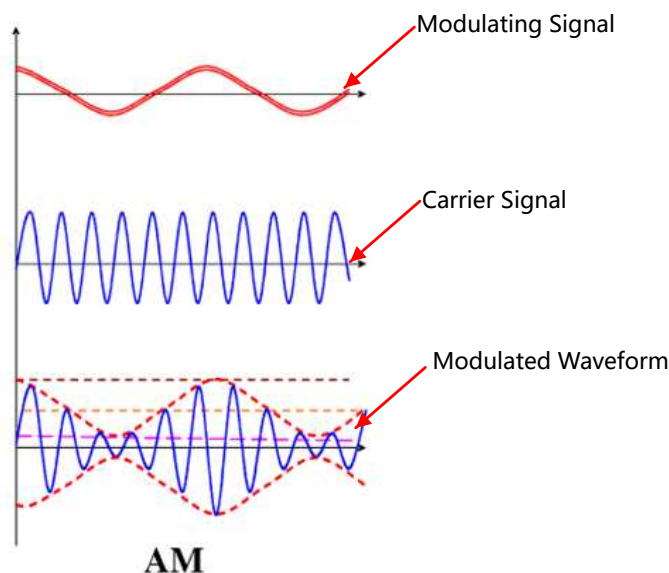

Figure 14.10 AM

#### Select the Modulation Type

Click or tap the drop-down button of **Mod. Type** to select "AM".

(Available Only for MHO5054/5104)

### Select the Modulating Waveform

The instrument uses the built-in signal to perform waveform modulation. Click or tap the drop-down button of **Waveform** to select the modulating waveform. The available waveform types include:

- Sine
- Square with 50% duty cycle
- Triangle with 50% symmetry
- UpRamp with 100% symmetry
- DnRamp with 0% symmetry
- Noise - white gaussian noise

### Set the Modulation Depth

Modulation depth is a percentage that represents the amplitude variation. Click or tap the input field of **Mod. Depth** to set the modulation depth with the pop-up numeric keypad. You can also use the specified knob indicated in the field to set it. The available range of the modulation depth is from 0% to 120%. By default, it is 100%.

- At 0% depth, the output amplitude is half of the carrier waveform amplitude.
- At 100% depth, the amplitude is identical to the carrier's amplitude setting.
- At >100% depth, the output amplitude of the instrument will not exceed 10 Vpp.

### Set the Modulation Frequency

When you select the modulating waveforms other than Noise, you can set the modulation frequency. Click or tap the input field of **Mod. Freq** to set the modulation frequency with the pop-up numeric keypad. You can also use the specified knob indicated in the field to set it. The available range of the AM frequency is from 2 mHz to 1 MHz.

### Enable the Modulation Output

Click or tap ON for **Mod. State** to enable the modulation function. In the Basic Waveforms interface, click or tap ON for **Output** to enable the waveform output. Then the modulated waveforms will be output from the specified AFG terminal based on the settings.

### DSSC

Click or tap ON for **DSSC** to enable the DSSC function. It can remove the carrier components from the output signal, improve the bandwidth usage, and improve the efficiency of transmission power.

## 14.2.2 FM

FM (Frequency Modulation), namely the frequency of the carrier waveform changes with the voltage of the modulating waveform.

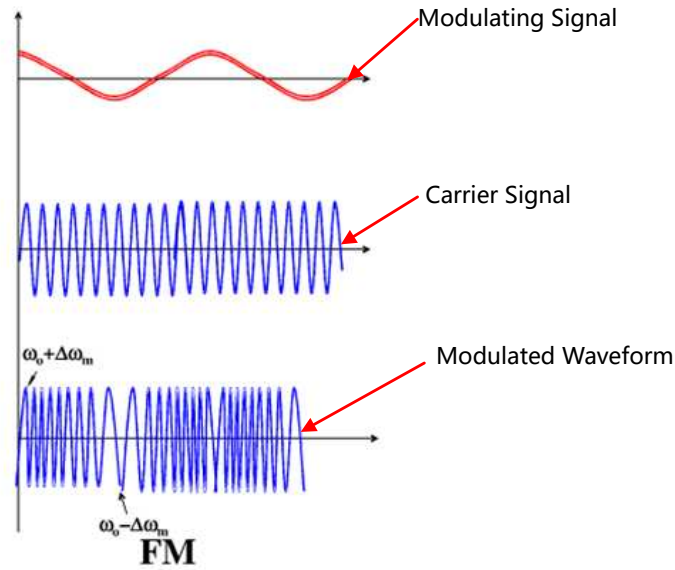

Figure 14.11 FM

### Select the Modulation Type

Click or tap the drop-down button of **Mod. Type** to select "FM".

### Select the Modulating Waveform

The instrument uses the built-in signal to perform waveform modulation. Click or tap the drop-down button of **Waveform** to select the modulating waveform. The available waveform types include:

- Sine
- Square with 50% duty cycle
- Triangle with 50% symmetry
- UpRamp with 100% symmetry
- DnRamp with 0% symmetry
- Noise - white gaussian noise

### Set the Frequency Deviation

It represents the peak variation in frequency of the modulated waveform from the carrier frequency. Click or tap the input field of **Deviation** to set the frequency deviation with the pop-up numeric keypad. You can also use the specified knob indicated in the field to set it. The settable FM frequency deviation range is from 2 mHz to the current frequency of the carrier waveform.

(Available Only for MHO5054/5104)

**TIP**

The frequency deviation plus the carrier frequency must be less than or equal to the selected carrier's maximum frequency.

**Set the Modulation Frequency**

When you select the modulating waveforms other than Noise, you can set the modulation frequency. Click or tap the input field of **Mod. Freq** to set the modulation frequency with the pop-up numeric keypad. You can also use the specified knob indicated in the field to set it. The available range of the FM frequency is from 2 mHz to 1 MHz.

**Enable the Modulation Output**

Click or tap ON for **Mod. State** to enable the modulation function. In the Basic Waveforms interface, click or tap ON for **Output** to enable the waveform output. Then the modulated waveforms will be output from the specified AFG terminal based on the settings.

### 14.2.3 PM

PM (Frequency Modulation), namely the phase of the carrier waveform changes with the voltage of the modulating waveform.

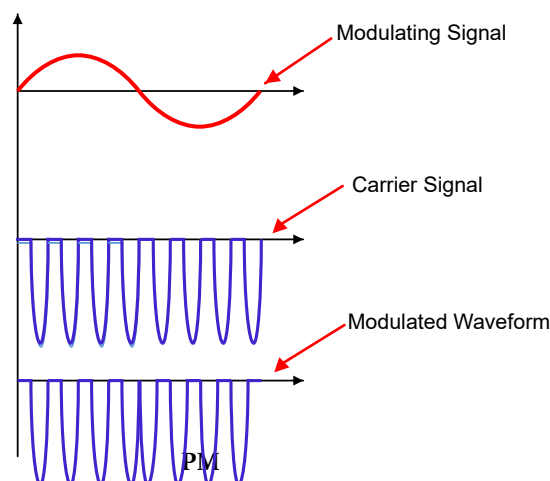
**Figure 14.12 PM****Select the Modulation Type**

Click or tap the drop-down button of **Mod. Type** to select "PM".

### Select the Modulating Waveform

The instrument uses the built-in signal to perform waveform modulation. Click or tap the drop-down button of **Waveform** to select the modulating waveform. The available waveform types include:

- Sine
- Square with 50% duty cycle
- Triangle with 50% symmetry
- UpRamp with 100% symmetry
- DnRamp with 0% symmetry
- Noise - white gaussian noise

### To Set the Phase Deviation

The phase deviation represents the peak variation in phase of the modulated waveform from the carrier waveform. Click or tap the input field of **Phase Dev** to set the phase deviation with the pop-up numeric keypad. You can also use the specified knob indicated in the field to set it. The available setting range of the phase deviation is from 0° to 360°. By default, it is 90°.

### Set the Modulation Frequency

When you select the modulating waveforms other than Noise, you can set the modulation frequency. Click or tap the input field of **Mod. Freq** to set the modulation frequency with the pop-up numeric keypad. You can also use the specified knob indicated in the field to set it. The available range of the PM frequency is from 2 mHz to 1 MHz.

### Enable the Modulation Output

Click or tap ON for **Mod. State** to enable the modulation function. In the Basic Waveforms interface, click or tap ON for **Output** to enable the waveform output. Then the modulated waveforms will be output from the specified AFG terminal based on the settings.

## 15 Bode Plot (Available Only for MHO5054/5104)

Bode plot is a way of graphically displaying the frequency response of a system. In the switch power supply and operational amplifier's circuit feedback network, the Bode plot provides the curves displaying the variation of gain and phase with the frequency for a loop analysis. Through the analysis on the system's gain and phase margins, you can determine the stability of the system.

With the built-in signal generator module, the digital oscilloscope generates the sweep signal of a specified frequency range and outputs to the switch power supply circuit under test. Then, the oscilloscope draws a Bode plot displaying the variation of phase and gain with different frequencies. Click or tap the function navigation icon

 and select **Bode Plots** to enter the Bode Plots setting menu.

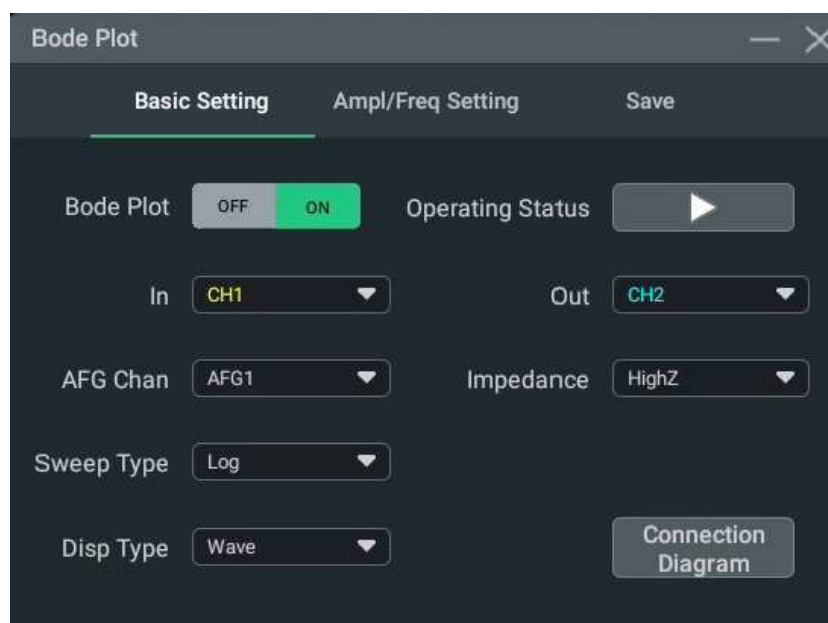



Figure 15.1 Bode Plots Setting Menu

Click or tap  to minimize the Bode Plots menu for a simplified interface.

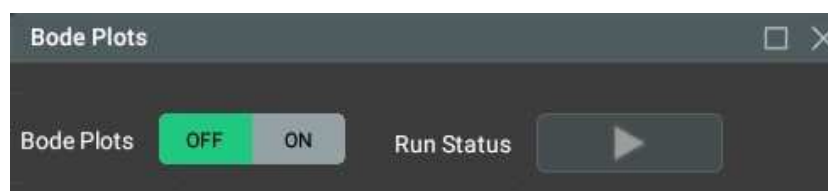

Figure 15.2 Bode Plots Setting Menu-Simplified Mode

**NOTE**

The Bode plot function can only test the response of basic devices such as amplifiers, but cannot test circuits with greater noise.

## 15.1 Basic Setting



Click or tap the **Basic Setting** tab to enter the basic setting menu. In this menu, you can enable or disable the Bode plot function, start or stop the Bode plot operation, set the input/output source, set the sweep type and display type, enable the filter, and check the connection diagram.

In the Bode Plots setting menu, click or tap the ON/OFF tab for **Bode Plots** to enable or disable the Bode function. After the Bode plot function is enabled, the Bode plot window will be displayed on the screen.

### 15.1.1 To Enable or Disable the Bode Plot Function

In the Bode Plots setting menu, click or tap the ON/OFF tab for **Bode Plots** to enable or disable the Bode function. After the Bode plot function is enabled, the Bode plot window will be displayed on the screen. For the Bode plot display interface, refer to *To Set the Display Type*.

### 15.1.2 To Start or Stop the Operation

After the Bode function is enabled, in the setting menu, click or tap the  button of **Run Status** to launch or stop the loop analysis test and bode plot drawing operation. The oscilloscope will perform a test on the loop based on the current bode setting and draw the Bode plot. In running status, the button of **Run Status** is displayed as . After the Bode plot drawing is finished, the **Run Status** button restores to .

During the Bode plot drawing process, if you want to stop the drawing, you can click or tap .

**NOTE**

Enabling the bode plot test automatically disables the bode plot setting menu. You can click or tap  at the upper-right side to open the setting menu.

### 15.1.3 To Set the Input/Output Source

- **Input Source:**

The input source indicates the channel input with the reference signal. The current frequency takes the frequency of this channel as the reference. You can optionally set the analog channel as the input source. The default analog channel is CH1. Before selecting the input source, connect the signal under test to the analog channel input terminal of the oscilloscope.

- **Output Source:**

The output source indicates the channel that connects the feedback output signal. You can optionally set the analog channel as the output source. The default analog channel is CH2. Before selecting the output source, connect the signal under test to the analog channel output terminal of the oscilloscope.

Analog channels are available as input and output sources. For channel numbers, refer to *Content Conventions in this Manual*.

## 15.1.4 To Set the Sweep Signal

### Sweep Source

You can optionally set **AFG channels** as the source to output the sweep signal. The default channel is AFG1.

### Sweep Type

Click or tap the **Sweep Type** drop-down button to select "Log" or "Line".

- **Line:** the frequency of the swept sine wave varies linearly with the time.
- **Log:** the frequency of the swept sine wave varies logarithmically with the time.

## 15.1.5 To Set the Display Type

Click or tap the **Display Type** drop-down button to select "Wave" or "Chart".



### Waveform Display

The Bode plot waveform display is as shown in the figure below. The X-axis value in the Bode plot represents the frequency and the Y-axis value represents the gain (red) and phase (green). The magnitude-frequency curve (red) represents the gain between system input and output. The phase-frequency curve (green) represents the phase deviation between system input and output.





**Figure 15.3 Bode Plot Waveform Display**

1. Cursor: rotate the multifunction knob 1 to move the cursor. The cursor information is displayed in the upper left corner.
2. Bode plot curves: magnitude-frequency curve (red) and phase-frequency curve (green).
3. Cursor information display:
  - Freq: X-axis value of the cursor.
  - Gain: Y-axis value of the crossover point between the cursor and the red magnitude-frequency curve.
  - Phase: Y-axis value of the crossover point between the cursor and the green phase-frequency curve.

The cursor appears as a white vertical line in the Bode plot waveform display. You can rotate the multifunction knob 1 to adjust the cursor position to view information about each point.
4. Margin result (displayed when the Bode plot operation stops):
  - PM: phase margin. It is the phase difference between the phase at 0 dB gain frequency point and 0-degree.
  - GM: gain margin. It is the gain measurement difference between the value at 0 dB and the frequency point at 0-degree phase. That is,  $GM = 0 \text{ dB} - \text{Gain Measurement Value}$ .
5. Operation button: click or tap  to open the Bode plot setting menu. Click or tap  to close the Bode plot waveform display and disable the Bode function.

## Chart Display

The Bode plot chart display is as shown in the figure below. It shows the frequency, gain, and phase of all sample points. Click or tap  to open the bode plot setting menu. Click or tap  to close the Bode plot chart and disable the Bode function.



| Index | Freq      | Gain    | Phase   |
|-------|-----------|---------|---------|
| 1     | 50.118kHz | -76.72  | -175.57 |
| 2     | 63.095kHz | -76.38  | 178.93  |
| 3     | 79.432kHz | -74.89  | 178.43  |
| 4     | 100kHz    | -64.44  | 179.04  |
| 5     | 158.48kHz | -69.26  | 178.31  |
| 6     | 199.52kHz | -112.25 | 136.40  |
| 7     | 251.18kHz | -79.00  | 178.47  |
| 8     | 316.22kHz | -71.33  | 177.20  |
| 9     | 398.10kHz | -75.46  | -178.16 |
| 10    | 501.18kHz | -101.27 | 166.63  |
| 11    | 794.32kHz | -84.24  | -178.96 |
| 12    | 1MHz      | -119.93 | -135.00 |
| 13    | 1.2589MHz | -116.12 | 159.97  |

Figure 15.4 Bode Plot Chart Display

## 15.1.6 To View the Connection Diagram

Before enabling the Bode plot function, make a proper loop connection. Click or tap **Connection Diagram** to view the circuit connection diagram in the pop-up window. See the connection diagram. Connect the front-panel AFG output interface of the oscilloscope to the isolation transformer. Inject the output signal of the isolation transformer to the terminals of the injection resistor of the circuit under test. Then measure the signals at the injection terminal and the output terminal.

## 15.2 Ampl/Freq Setting

Click or tap the **Ampl/Freq setting** tab to enter the ampl/freq setting menu, you can set the following ampl/freq parameters.

- **Start Frequency:** click or tap the **Start Freq** input field to set the start frequency of the sine wave with the pop-up keypad. You can also use the multifunction knob to set the value. The setting range is from 10 Hz to 24.99 MHz.

- **Stop Frequency:** click or tap the **Stop Freq** input field to set the stop frequency of the sine wave with the pop-up keypad. You can also use the multifunction knob to set the value. The setting range is from 100 Hz to 25 MHz.
- **Points/Decade:** click or tap the **Points/Decade** input field to set the number of displayed points per decade. You can also use the multifunction knob to set the value. The setting range is from 10 to 300. By default, it is 10.
- **Amplitude:** click or tap the **Amp** input field to set the voltage amplitude of the sine wave when the **Var.Amp.** is set to "OFF".
- **Variable Amplitude:** click or tap the ON/OFF tab for **Var.Amp.** to turn on or off the variable amplitude function. When it is on, you can set the voltage amplitude of the sine wave in different frequency ranges.

**TIP**

The "Stop Freq" must be greater than the "Start Freq".

## 15.3 To Store and Load

Click or tap the **Save** tab to enter the save menu, you can save and load the Bode plot data.

### Save the Test Data



1. Click or tap the **Format** drop-down button to select the format of the saved Bode plot. Available file types include "\*.csv" and "\*.html".
2. Click or tap the **File Name** input field to set the filename with the pop-up virtual keypad.
3. Click or tap the **File Path** input field and the "Disk" menu is displayed. Select the desired target path and then click or tap **OK** to set the path. For details about the Disk menu, refer to *Disk Management*.
4. Click or tap **save** to save the Bode plot file according to the settings.

### Load the Test Data

1. The **File Type** item displays the file type that can be loaded. It is specified as \*.csv.
2. Click or tap the **File Path** input field and the "Disk" menu is displayed. Select the desired target file and then click or tap **OK** to select the file. For details about the Disk menu, refer to *Disk Management*.
3. Click or tap **Load** to load the file. The saved test data will be displayed on the screen in a wave/chart format (depending on the display type setting).

## 16 Power Analysis (Option)

This series oscilloscope supports power analysis function, which can help you easily analyze the efficiency and reliability of the switching power supply. With the power analysis function, you can analyze the power quality and output ripple noise of the input power. To enter the **UPA** interface, perform any of the following operations:

- Click or tap  and select **UPA** to enter the "UPA" menu.
- Press the front-panel  key and then select **UPA** to enter the "UPA" menu.

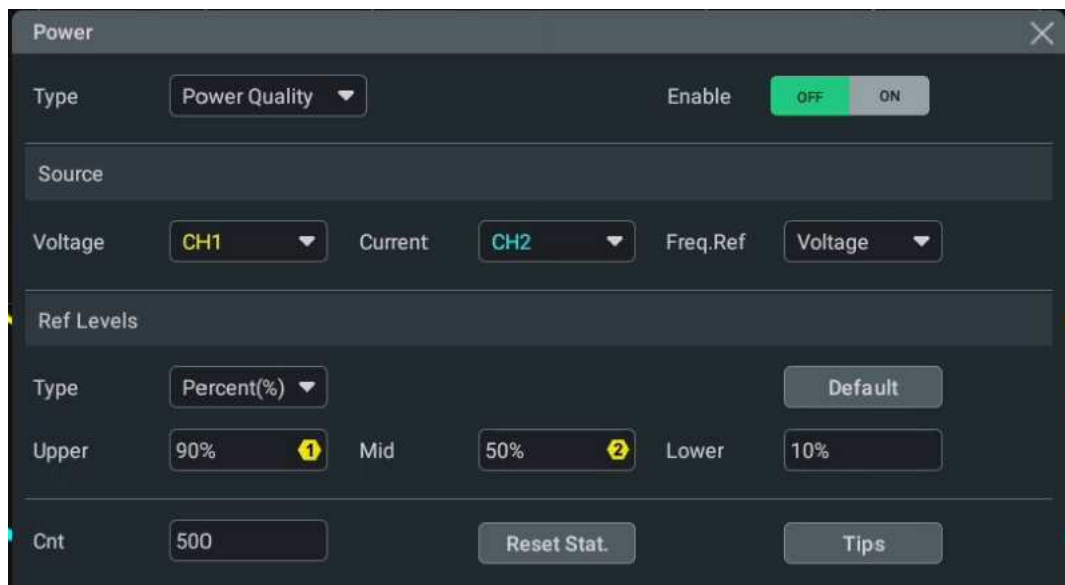

Figure 16.1 Power Analysis Interface

### 16.1 Power Quality

By analyzing the power quality, you can test the quality of AC input lines. The specific measurement parameters for power quality analysis include reference frequency,  $V_{RMS}$ ,  $I_{RMS}$ , real power, apparent power, reactive power, power factor, phase angle, impedance, voltage crest factor, and current crest factor.

In the power analysis interface, click or tap **Type** to select **Power Quality**.

#### Set Power Quality Analysis Source

- Click or tap the drop-down button of **Voltage** to select the desired voltage source from the drop-down list. The sources include CH1 to CH8.
- Click or tap the drop-down button of **Current** to select the desired current source from the drop-down list. The sources include CH1 to CH8.

- Click or tap the drop-down button of **Freq.Ref** to select "Voltage" or "Current" as the frequency reference.

#### Set the Reference Level

- Click or tap the **Type** drop-down button to set the reference level display type to "Percent(%)" or "Absolute".
- Click or tap the **Upper** drop-down button to set the upper limit value with the pop-up numeric keypad. You can also use the corresponding multifunction knob to set the value. The upper limit value should be greater than the middle value.
- Click or tap the **Mid** drop-down button to set the middle value with the pop-up numeric keypad. You can also use the corresponding multifunction knob to set the value. The middle value should be less than the upper limit value and greater than the lower limit value.
- Click or tap the **Lower** drop-down button to set the lower limit value with the pop-up numeric keypad. You can also use the corresponding multifunction knob to set the value. The lower limit value should be less than the middle value.
- Click or tap **Default**, and then the upper limit, middle value, and lower limit will be restored to the defaults.

#### Set the Count

Click or tap the input field of **Count** to set the statistical count of the power quality analysis with the pop-up virtual numeric keypad. You can also use the specified knob indicated in the input field to set it. The value range of the count is from 1 to 1,000. By default, it is 500.

Click or tap **Reset Stat.** to clear the current data and execute statistics on the measurement results again.

#### Enable the Power Analysis

Click or tap the ON/OFF tab for **Enable** to enable or disable the power quality analysis. When enabled, the statistical results of the power quality analysis will be displayed on the screen. Click or tap the close icon  at the upper-right corner of the power analysis result interface to close the window.

| Index | Name        | Source | Current    | Average    | Maximum    | Minimum    | Deviation  | Count |
|-------|-------------|--------|------------|------------|------------|------------|------------|-------|
| 1     | Ref_Freq    | Chan1  | 1.25...Hz  | 1.250...Hz | 1.25...Hz  | 1.248...Hz | 1.25...kHz | 261   |
| 2     | Vrms        | Chan1  | 190....mV  | 190....mV  | 190....mV  | 190....mV  | 0.0000V    | 261   |
| 3     | Irms        | Chan2  | 741.67uA   | 710.34uA   | 774.90uA   | 649.79uA   | 22.561uA   | 261   |
| 4     | Real_P      | Math1  | -12.9...uW | -11.7...uW | -8.72...uW | -13.8...uW | 965....nW  | 261   |
| 5     | App...t_P   | Chan1  | 140...uVA  | 135....uVA | 147...uVA  | 123....uVA | 4.2...uVA  | 261   |
| 6     | Rea...e_P   | Chan1  | 140...VAR  | 134...VAR  | 146...VAR  | 123...VAR  | 4.2...VAR  | 261   |
| 7     | P_Factor    | Chan1  | -91.991m   | -86.669m   | -65.903m   | -100.15m   | 5.4106m    | 261   |
| 8     | Pha...ngle  | Chan1  | 95.278°    | 94.972°    | 95.748°    | 93.778°    | 302.98m°   | 261   |
| 9     | Imp         | Chan1  | 256.25Ω    | 267.81Ω    | 292.47Ω    | 245.25Ω    | 8.5096Ω    | 261   |
| 10    | V Cr...ctor | Chan1  | 1.1493     | 1.1494     | 1.1494     | 1.1493     | 0.0000     | 261   |
| 11    | I Cr...ctor | Chan2  | 1.8876     | 2.3279     | 3.3320     | 1.8199     | 257.73m    | 261   |

Figure 16.2 Power Quality Analysis Result Display

#### TIP

When the power quality analysis is enabled, its result is displayed on the screen. Meanwhile, the multiplication operation is also enabled automatically.

#### View the Connection Diagram

Click or tap **Diagram**, and then the connection diagram of the power quality analysis is displayed on the screen. Please connect the cables according to the connection method in the diagram. To close the connection diagram window, click or tap the close icon  at the upper-right corner of the connection diagram window.

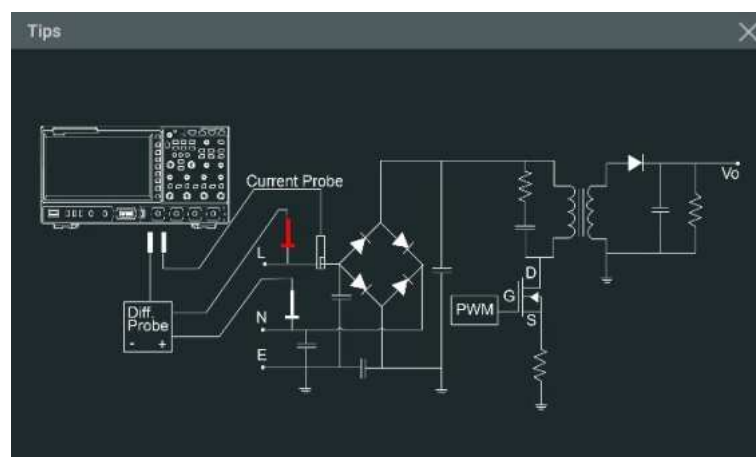

Figure 16.3 Connection Diagram of Power Quality Analysis

## 16.2 Ripple

Power ripple is an important parameter for evaluating DC power supply, which indicates the ripple quantity of the output DC voltage. The ripple analysis can measure the current value, average value, minimum value, maximum value, standard deviation, and count value of the ripples on the power output terminal.

### TIP

1:1 probe is recommended for ripple measurement. For example, PVP2150 and PVP2350.

Click or tap the drop-down button of **Type** to select "Ripple".

### Set Rippler Analysis Source

Click or tap the drop-down button of **Source** to select the desired source from the drop-down list. The sources include CH1 to CH8.

### Set Count

Click or tap the input field of **Count** to set the ripple count value with the pop-up virtual numeric keypad. You can also use the specified knob indicated in the input field to set it. The range of the count is from 1 to 1,000. By default, it is 500.

### Reset Statistics

Click or tap **Reset Stat.** to clear the current data and execute statistics on the measurement results again.

### View the Statistics of the Results

Click or tap the ON/OFF tab for **Enable** to enable or disable the display of the ripple results. When enabled, the statistical results will be displayed on the screen, as shown in the following figure. Click or tap the close icon  at the upper-right corner of the power analysis result interface to close the window.

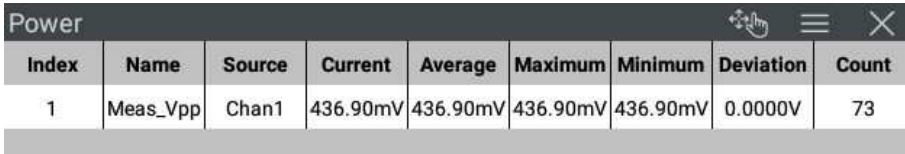

| Index | Name     | Source | Current  | Average  | Maximum  | Minimum  | Deviation | Count |
|-------|----------|--------|----------|----------|----------|----------|-----------|-------|
| 1     | Meas_Vpp | Chan1  | 436.90mV | 436.90mV | 436.90mV | 436.90mV | 0.0000V   | 73    |

Figure 16.4 Ripple Analysis Result Display

### View the Connection Diagram

Click or tap **Diagram**, and then the connection diagram of the ripple analysis is displayed on the screen. Please connect the cables according to the connection method as shown in the diagram. To close the connection diagram window, click or tap the close icon  at the upper-right corner of the connection diagram window.

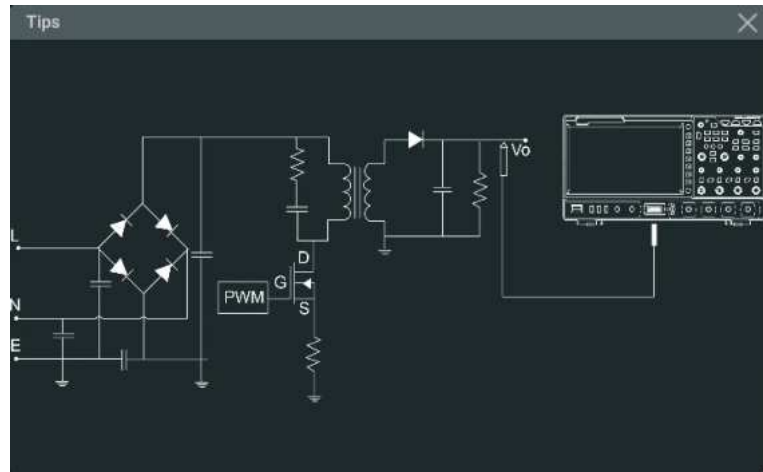



Figure 16.5 Connection Diagram of Ripple Analysis

## 17 Reference Waveform

This series oscilloscope provides 10 reference waveform positions (Ref1~Ref10). In the actual test process, you can compare the signal waveform with the reference waveform to locate the failure.

### 17.1 To Enable the Ref Function

To enter the **Ref** interface, perform any of the following operations:

- Click or tap the function navigation icon  at the lower-left corner of the screen, and then select **Ref** to enter the reference waveform function menu.
- Press the front-panel  key to enter the reference waveform function menu.

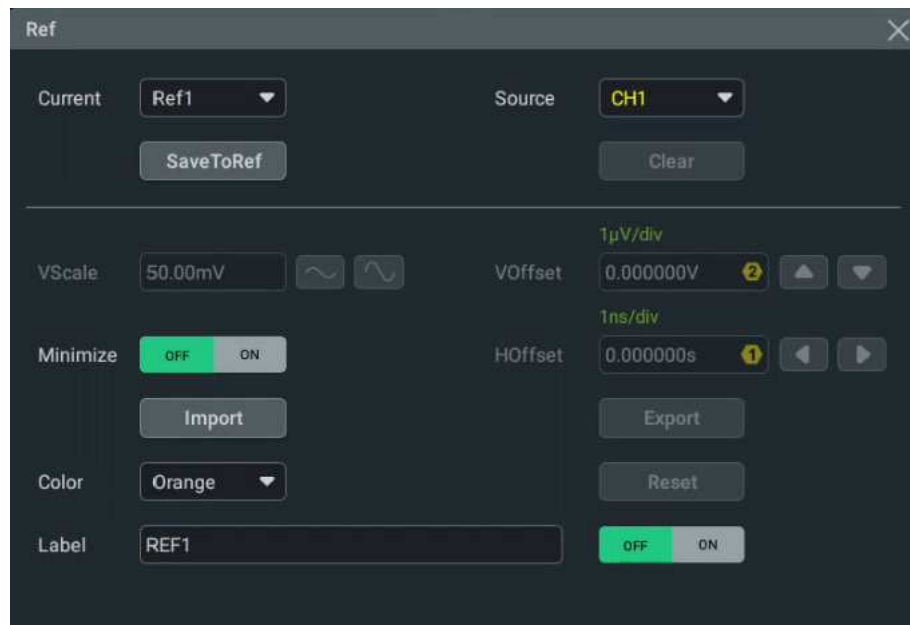

Figure 17.1 Reference Waveform Menu

### 17.2 To Set the Reference Waveform

In the **Ref** menu, you can specify a channel to serve as the reference channel, save and clear the reference channel.

#### To Select the Reference Channel

Click or tap the drop-down button of **Current** to select the reference waveform channel (Ref1-Ref10). By default, Ref1 is enabled.

### Select the Ref Source

Click or tap the drop-down button of **Source** to select the desired source of the reference waveform. The available sources include analog channels, digital channels, and Math1~Math4.



#### NOTE

For the channel sources supported by different models, refer to *Content Conventions in this Manual*

### To Save the Reference Waveform to Internal Memory

Click or tap **SaveToRef** to save the displayed waveform for the specified source to the internal memory as the reference waveform.



#### CAUTION

This operation only saves the reference waveform to the volatile memory, and the waveform will be cleared at power-off or restoring to the default settings. If you want to store reference waveforms that can be recalled when necessary, please export the waveform to internal or external memory (*To Export to Internal or External Memory*).

### To Clear the Specified Reference Waveform

Click or tap **Clear** to clear the specified reference waveform for the "current channel".

You can also click or tap the **Clear** button in the function navigation menu or press the front-panel  key to clear the reference waveforms of all the reference channels.

## 17.3 To Set the Ref Waveform Display

After pressing **SaveToRef**, you can adjust the vertical scale, vertical offset, and horizontal offset of the reference waveform specified under **Current**.

### Adjust the Vertical Scale

Click or tap the input field of **VScale** to input the vertical scale of the reference waveform with the pop-up numeric keypad. You can also click or tap the icon  at the right of the input field of **Vscale** to increase or decrease the vertical scale. Also, you can use the specified multifunction knob indicated in the input field to set the value.

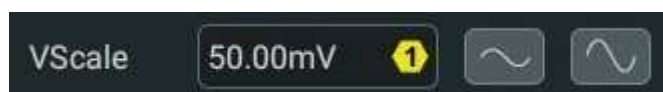

### Modify the Vertical Offset

Click or tap the input field of **VOffset** to set the vertical offset of the reference waveform with the pop-up numeric keypad. You can also click or tap the icon  at the right of the input field of **VOffset** to increase or decrease the vertical offset. Also, you can use the specified multifunction knob indicated in the input field to set the value.

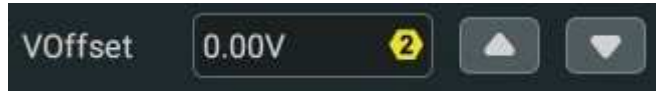

### Horizontal Offset

Click or tap the input field of **HOffset** to set the horizontal offset of the reference waveform with the pop-up numeric keypad. You can also click or tap the icon  at the right of the input field of **HOffset** to increase or decrease the horizontal offset. Also, you can use the specified multifunction knob indicated in the input field to set the value.

### Reset the Reference Waveform

After you have done the save operation for the reference waveform and you want to restore the reference waveform to the position prior to its last **Save** operation, Click or tap **Reset**.

### Set the Reference Waveform Color

This series oscilloscope provides five colors (gray, green, light blue, red, and orange) to mark the reference waveforms of different channels in order to distinguish them.

Click or tap the drop-down button of **Color** to select the color of the reference waveform of the channel.

### Set the Reference Waveform Label

Click or tap the ON/OFF tab for **Label** to enable or disable the label display of the specified reference waveform.

Click or tap the input field of **Label** to set the label of the specified reference waveform with the pop-up keypad.

## 17.4 Export and Import Operation

### To Export to Internal or External Memory

You can save the current reference waveform to the internal memory or external USB storage device. The file format of the reference waveform is "\*.ref\*.bin", "\*.csv".

Click or tap **Export** to enter the reference waveform file saving interface.

- **Set the Format**

In the file saving interface, click or tap the drop-down button of **Format** to select "\*.ref", "\*.bin", or "\*.csv" as the saving format.

- **Set the Filename**

Click or tap the input field of **File Name**, then the filename editing interface is displayed. Input the filename with the pop-up numeric keypad.

- **Set the Save Path**

Click or tap the **File Path** input field, then the disk management Menu is displayed. Through the disk management menu, you can save the current reference waveform to the internal memory or external USB storage device. Then click or tap **Save** to complete the save operation. For details about the disk management operation, refer to the *Disk Management* section in *Store and Load*.

**TIP**

- Only when the reference waveform is saved, can this export function be valid.
- This series only supports the flash memory USB storage device of FAT32 format.
- For the ".bin" format file, refer to *Binary Data Format (.bin)*.

**To Import from Internal or External Memory**

You can import the stored reference waveform file from the internal memory or external USB storage device to the instrument and display the file on the screen.

Click or tap **Import** to enter the reference waveform file loading interface.

- **Set the Format**

In the file loading interface, click or tap the drop-down button of **Format** to select "\*.ref" as the loading format.



- **Set the Load Path**

Click or tap the input field of **File Path**, then the disk management interface is displayed.

Through the disk management menu, you can load the current reference waveform to the waveform view of the oscilloscope. Then click or tap **Load** to complete the load operation. For details about the disk management operation, refer to the *Disk Management* section in *Store and Load*.

## 18 Pass/Fail Test

During the product design and manufacturing process, you usually need to monitor the variations of the signal or judge whether the product is up to standard. The pass/fail test function of this series oscilloscope can accomplish this task perfectly. With this function, you can set the test mask based on the known "basic" waveforms, then compare the signal under test with the "basic" waveforms to display the test result. When a successful or failed event is detected, you can set the error action performed by the instrument, such as stopping immediately, enabling the beeper to sound, and capturing the current screen shot.

Click or tap the function navigation icon  at the lower-left corner of the screen to open the function navigation menu. Click or tap to select **Pass/Fail** to enter the pass/fail test interface. You can also press  on the front panel, then click or tap **Pass/Fail** to enter the pass/fail test interface.

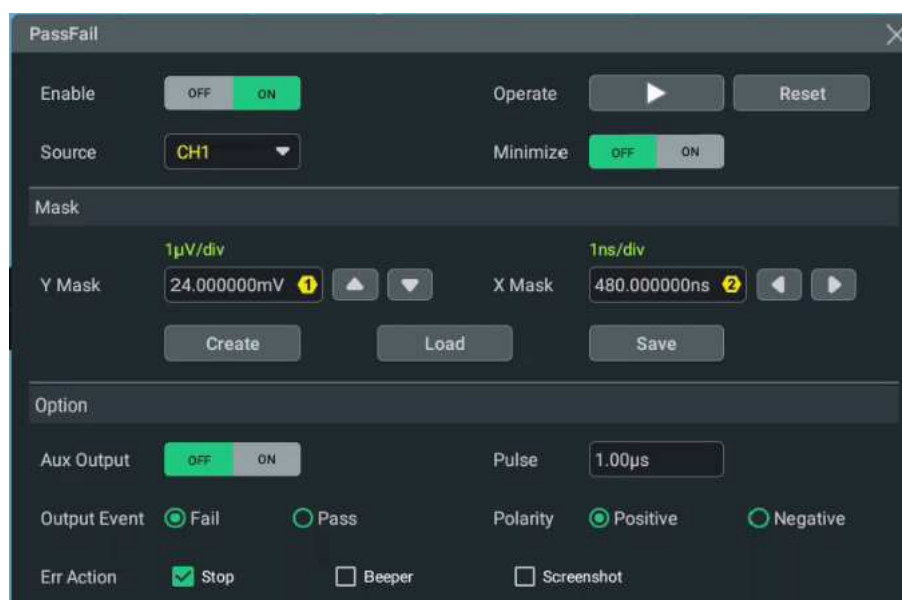



Figure 18.1 Pass/Fail Test Menu

### 18.1 To Start or Stop the Pass/Fail Test Operation

After you have enabled the pass/fail test and completed the settings in the **Pass/Fail** menu, click or tap  for the **Operate** menu item to start the test. During testing, click or tap  to suspend testing at any time.

During the test process, the oscilloscope will test the waveforms, display the test information, and output the test information based on the current of settings. The

"Pass/Fail" measurement results are displayed at the right side of the screen under the "Result" list. The test Interface is as shown in the figure below.

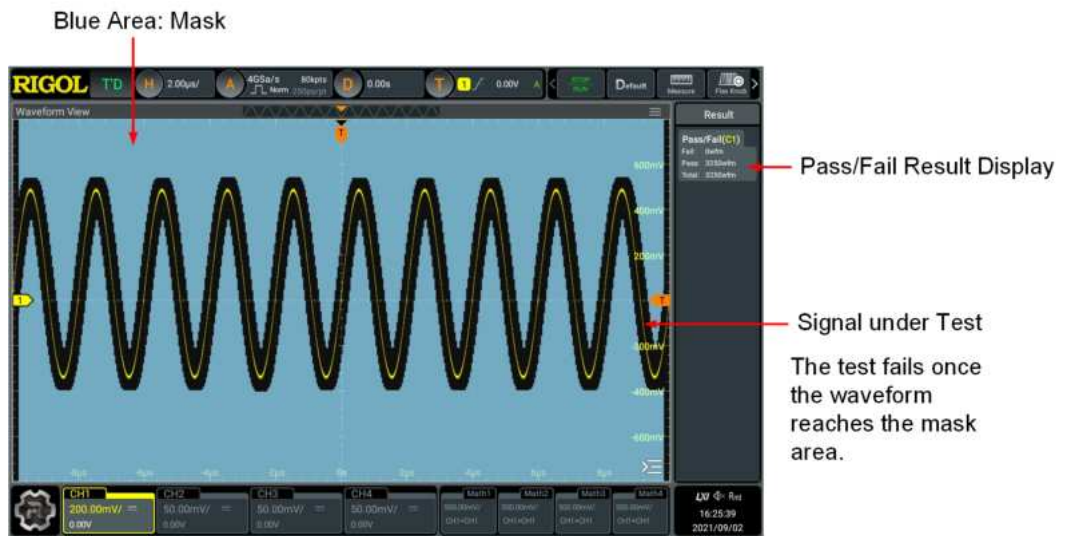

Figure 18.2 Pass/Fail Test Interface



#### TIP

- Only when the pass/fail test function is enabled, can you start or stop the pass/fail test operation, save and load the test mask.
- After starting the test operation, you can neither modify the source channel nor adjust the test mask.

## 18.2 To Select the Source

Click or tap the drop-down button of **Source** to select the desired source from the drop-down list. The available channels include CH1 to CH8.



#### TIP

When the disabled channel is selected as the source, it will be enabled automatically.

## 18.3 To Set the Test Mask

In the **Pass/Fail** menu, you can self-define the pass/fail test mask, save and load the test mask.

### Create a Mask

Click or tap the input field of **X Mask** and **Y Mask** respectively to set the horizontal tolerance range and vertical tolerance range with the pop-up numeric keypad. You can also use the Up/Down arrow at the right side of the input field of **Y Mask** to adjust the value of Y Mask; use the Left/Right arrow at the right side of the input field

of **X Mask** to adjust the value of X Mask. Also, you can use the specified knob indicated in the input field of Y Mask and X Mask to set it respectively. After configuring the settings, click or tap **Create** to apply the currently created mask (the region not covered by blue within the screen).

### Load a Mask

When the pass/fail test function is enabled, you can load the test mask files from the internal memory or external USB storage device (when detected) and apply them to the current pass/fail test function.

Click or tap **Load** to enter the file loading interface. Click or tap the input field of **File Path** to load the specified test mask files (in \*.pf format) and apply them to the current pass/fail test function. For detailed operations, refer to descriptions of *Disk Management* in *Storage*.

### Save a Mask

When the pass/fail test function is enabled, you can save the current test mask range to the internal memory or external USB storage device (when detected) in "\*.pf" format.

Click or tap **Save** to enter the file saving interface. Click or tap the input field of **File Name** and **File Path** to input the filename and select the desired file path to save the test mask file to the internal or external memory. For detailed operations, refer to descriptions of *Disk Management* in *Storage*.

## 18.4 To Set the Output Form of the Test Results

In the "Option" menu of the pass/fail test interface, you can set the follow-up operations that the oscilloscope will do when test results are generated according to your needs.

### Set the Output Event and Aux Output

- Click or tap the ON/OFF tab for **Aux Output** to enable or disable the Aux output.
  - When enabled, in the **Utility** menu, the sub-menu **AUX Out** under the **Setup** menu is automatically set to "PassFail". When a successful or failed event is detected, a pulse will be output from the **[AUX OUT]** connector.
  - If disabled, in the **Utility** menu, the sub-menu **AUX Out** under the **Setup** menu is automatically set to "TrigOut". The output of the **[AUX OUT]** connector is irrelevant with the pass/fail test.
- Click or tap to select "Pass" or "Fail" for the **Output Event** menu. Then when the specified output event is detected, a pulse will be output from the **[AUX OUT]** connector.

### Set the Output Polarity and Output Pulse Width

Click or tap to select "Positive" or "Negative" for the **Polarity** menu. Then click or tap the input field of **Pulse** to set the pulse width with the pop-up numeric keypad. You can also use the specified knob indicated in the field to set the value. The available range is from 100 ns to 10 ms. By default, it is 1  $\mu$ s.



### Set the Error Action

In the **Err Action** menu, you can set the follow-up operations that the oscilloscope will do when a failed event is detected.

- **Stop:** indicates stopping sampling when a failed test event is detected.
- **Beeper:** indicates that the beeper sounds an alarm (irrelevant with the on/off status of the beeper of the instrument) when a failed test event is detected.
- **Screenshot:** captures the screen when a failed test event is detected. If an external storage device is detected, the screenshot will be saved to the external storage device directly. Otherwise, it will be saved to the local disk.

If "Screenshot" is selected, "Stop" action will be executed forcibly. The sampling operation will be stopped automatically. After the Screenshot operation is completed, the sampling will continue.

## 18.5 To Start or Stop the Pass/Fail Test Operation

After you have enabled the pass/fail test and completed the settings in the **Pass/Fail** menu, click or tap  for the **Operate** menu item to start the test. During testing, click or tap  to suspend testing at any time.

During the test process, the oscilloscope will test the waveforms, display the test information, and output the test information based on the current of settings. The "**Pass/Fail**" measurement results are displayed at the right side of the screen under the "Result" list. The test Interface is as shown in the figure below.

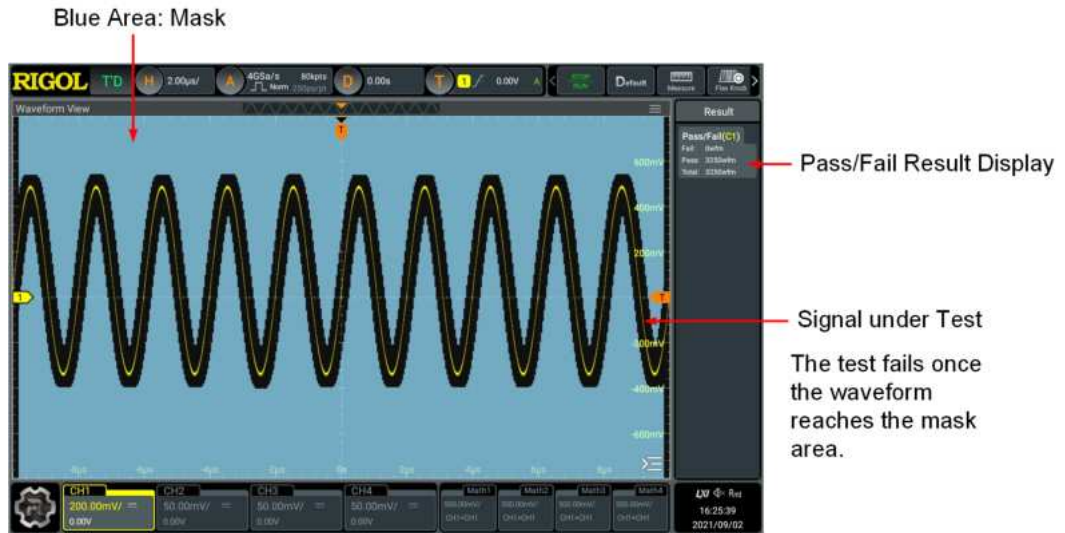



Figure 18.3 Pass/Fail Test Interface

**TIP**

- Only when the pass/fail test function is enabled, can you start or stop the pass/fail test operation, save and load the test mask.
- After starting the test operation, you can neither modify the source channel nor adjust the test mask.

## 18.6 To Display the Statistics Information of the Test Results

When the "Pass/Fail" test is enabled, the test results are displayed under the "Result" list at the right side of the screen. Click or tap the icon  at the lower-right part of the waveform view to fold the result list.

The statistics information in the pass/fail test results includes number of failed frames, number of passed frames, and the total number of frames, as shown in the figure below.

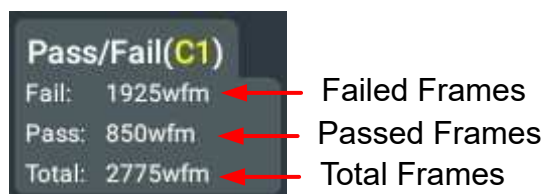

Click or tap the test results under the result list, then the sub-menus are displayed. You can perform the following operations:

- Click or tap **Reset Stat.** to reset the test results to zero.

- Click or tap **Setting** to enter the pass/fail setting interface.
- Click or tap **Remove** to disable the pass/fail function and exit the current interface.

## 19 Protocol Decoding

You can use the protocol analysis to discover errors, debug hardware, and accelerate development easily, ensuring you to accomplish the projects with high speed and good quality. Protocol decoding is the basis of protocol analysis. Only protocol analyses with correct protocol decoding are acceptable, and only correct protocol decoding can identify more error information. This oscilloscope provides four bus decoding modules (Decode 1, Decode 2, Decode 3, and Decode 4) to make common protocol decoding for the input signals of the analog channels. It provides standard serial decodes including Parallel, RS232/UART, I2C, SPI, and CAN and optional serial decodes including LIN, CAN-FD, FlexRay, I2S and MIL-STD1553. As the decoding functions and setting methods of Decode1, Decode2, Decode3, and Decode4 are the same, this chapter takes Decode1 as an example for illustration.

- Click or tap  > **Decode** to enter the "Decode" menu.
- Click or tap the **Decode** button on the toolbar to enter the "Decode" menu.

To get the decoding option information, refer to descriptions in [Appendix A: Options and Accessories](#).

If you have purchased the decoding option, activate it according the descriptions in [Appendix A: Options and Accessories](#).

### 19.1 Parallel Decoding

Parallel bus consists of clock line and data line. As shown in the figure below, CLK is the clock line, whereas Bit0 and Bit1 are the 0 bit and 1st bit on the data line respectively. The oscilloscope will sample the channel data on the rising edge, falling edge, or the rising/falling edge of the clock and judge each data point (logic "1" or logic "0") according to the preset threshold level.

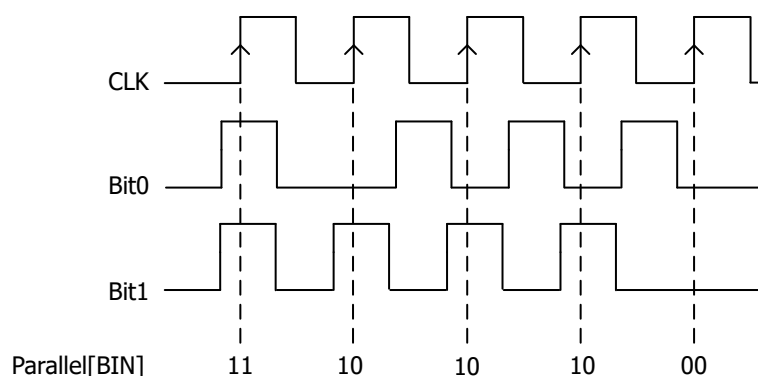

**Figure 19.1 Schematic Diagram of Parallel Decoding**

In the **Decode** menu, click or tap the drop-down button of **Bus Type** to select **Parallel**, then configure the parameters for Parallel decoding.

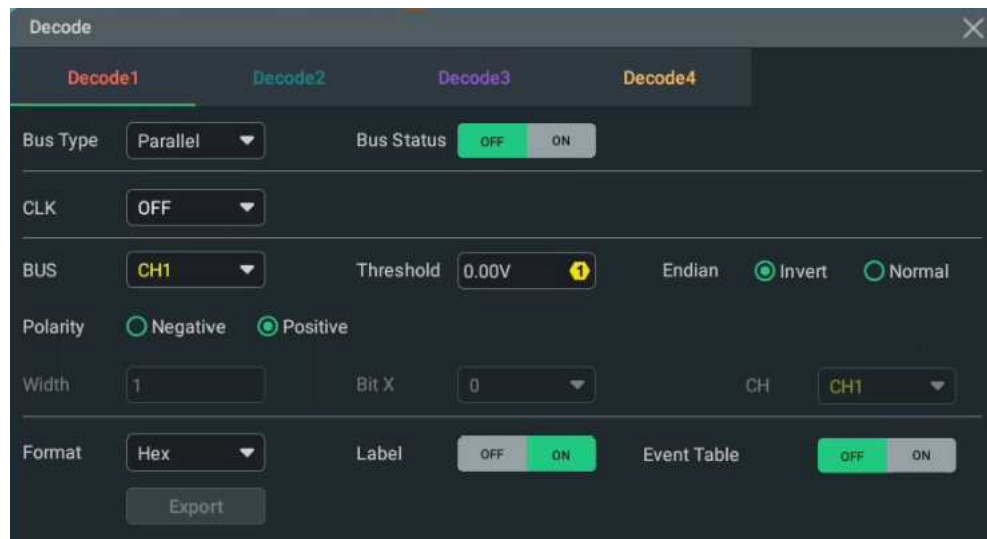

Figure 19.2 Parallel Decoding Menu

### Bus Status

Click or tap the ON/OFF tab for **Bus Status** to enable or disable the bus decoding.

## 19.1.1 Clock Setting (CLK)

### Clock Setting (CLK)

Click or tap the drop-down button of **CLK** to select the analog channels or digital channels as the clock channel. If "OFF" is selected, no clock channel is set, and sampling is performed when a hop occurs to the data of the data channel during decoding.

#### NOTE

For the supported channels of each model, refer to *Content Conventions in this Manual*

### Threshold

You need to set a threshold when configuring the clock channel. Click or tap the input field of **Threshold**, and then use the pop-up numeric keypad to set the threshold. You can also use the corresponding multifunction knob to set the value. The range of the threshold is related to the current vertical scale and offset.

### CLK Edge

You can select "Rising", "Falling", or "Both" in **CLK Edge** when configuring the clock channel.

- **Rising:** samples the channel data on the rising edge of the clock.
- **Falling:** samples the channel data on the falling edge of the clock.
- **Both:** samples the channel data on the rising edge or the falling edge of the clock.

## 19.1.2 Bus Setting

### Set the Bus

You can select analog channels or digital channels for Parallel decoding bus from the drop-down list of **BUS**. For the supported channels of each model, refer to *Content Conventions in this Manual*.

**Table 19.1 Bus Setting of DHO Series 8-CH Model**

| Bus | Width | Bit X | Channel | Remarks   |
|-----|-------|-------|---------|---|
| CH1 | 1     | 0     | CH1     | Width, Bit X, and CH are set automatically, and you cannot modify them. |
| CH2 | 1     | 0     | CH2     | Width, Bit X, and CH are set automatically, and you cannot modify them. |
| CH3 | 1     | 0     | CH3     | Width, Bit X, and CH are set automatically, and you cannot modify them. |
| CH4 | 1     | 0     | CH4     | Width, Bit X, and CH are set automatically, and you cannot modify them. |
| CH5 | 1     | 0     | CH5     | Width, Bit X, and CH are set automatically, and you cannot modify them. |
| CH6 | 1     | 0     | CH6     | Width, Bit X, and CH are set automatically, and you cannot modify them. |
| CH7 | 1     | 0     | CH7     | Width, Bit X, and CH are set automatically, and you cannot modify them. |

| Bus  | Width                 | Bit X       | Channel | Remarks   |
|------|-----------------------|-------------|---------|---|
| CH8  | 1                     | 0           | CH8     | Width, Bit X, and CH are set automatically, and you cannot modify them. |
| User | 1 to 8, 1 for default | 0 (Default) | CH1-CH8 | When the bus is set to "User", you can set the bus width.               |

Table 19.2 Bus Setting of MHO Series 4-CH Model

| Bus    | Width | Bit X       | Channel      | Remarks   |
|--------|-------|-------------|--------------|---|
| CH1    | 1     | 0           | CH1          | Width, Bit X, and CH are set automatically, and you cannot modify them.   |
| CH2    | 1     | 0           | CH2          | Width, Bit X, and CH are set automatically, and you cannot modify them.   |
| CH3    | 1     | 0           | CH3          | Width, Bit X, and CH are set automatically, and you cannot modify them.   |
| CH4    | 1     | 0           | CH4          | Width, Bit X, and CH are set automatically, and you cannot modify them.   |
| D7-D0  | 8     | 0 (Default) | D0 (Default) | Bit0 to Bit7 are set to D7 to D0 respectively. <b>Width</b> is set automatically, and you cannot modify them.   |
| D15-D8 | 8     | 0 (Default) | D8 (Default) | Bit0 to Bit7 are set to D15 to D8 respectively. <b>Width</b> is set automatically, and you cannot modify them.  |
| D15-D0 | 16    | 0 (Default) | D0 (Default) | Bit0 to Bit15 are set to D15 to D0 respectively. <b>Width</b> is set automatically, and you cannot modify them. |
| D0-D7  | 8     | 0 (Default) | D7 (Default) | Bit0 to Bit7 are set to D0 to D7 respectively. <b>Width</b> is set  |

| Bus    | Width                 | Bit X       | Channel         | Remarks   |
|--------|-----------------------|-------------|-----------------|---|
|        |                       |             |                 | automatically, and you cannot modify them.  |
| D8-D15 | 8                     | 0 (Default) | D15 (Default)   | Bit0 to Bit7 are set to D8 to D15 respectively. <b>Width</b> is set automatically, and you cannot modify them.  |
| D0-D15 | 16                    | 0 (Default) | D15 (Default)   | Bit0 to Bit15 are set to D0 to D15 respectively. <b>Width</b> is set automatically, and you cannot modify them. |
| User   | 1 to 4, 1 for default | 0 (Default) | CH1-CH4, D0-D15 | When the bus is set to "User", you can set the bus width.   |

### Set the Threshold Level

When the analog channel is set as the bus source, to judge logic "1" and logic "0" of the buses, you need to set a threshold for each analog channel. When the channel signal amplitude is greater than the preset threshold, it is judged as logic "1"; otherwise logic "0".

Click or tap the input field of **Threshold**, and then use the pop-up numeric keypad to set the threshold. You can also use the corresponding multifunction knob to set the value. The range of the threshold is related to the current vertical scale and offset.

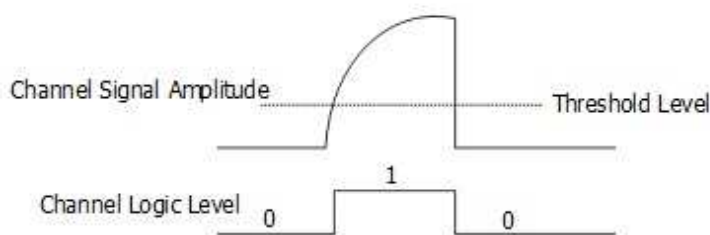

### Endian

In **Endian**, select "Invert" or "Normal" as the endian of the bus.

### Polarity

In **Polarity**, select "Positive" or "Negative" as the data polarity.

## 19.1.3 Display-related Setting

In the **Decode** menu, set the following display-related parameters.

### Set the Display Format

Click or tap the drop-down button of **Format** to select the display format of the bus data and the event table. The available formats include "Hex", "Dec", "Bin", and "ASCII".

### Set the Label Display

Click or tap the ON/OFF tab for **Label** to enable or disable the label display of the decoding bus. When enabled, the bus label will be displayed at the upper-left side of the bus (when the bus display is enabled). The label shows the current bus type.

## 19.1.4 Event Table

The event table displays the decoded data and the corresponding decoding information in time order in the form of a table. It can be used to observe relatively longer decoded data. The decoding information includes the decoded data, the corresponding line number, and time information.

### Open or Close the Event Table

Click or tap the ON/OFF tab for **Event Table** to enable or disable the display of the event table. When enabled, the event table is displayed as shown in the figure below.

You can also click or tap the icon  at the upper-right corner of the table to close the event table.



Figure 19.3 Parallel Decoding Event Table



### TIP

- When you adjust the horizontal time base, the waveform displayed on the screen will also change, and the total number of lines containing the decoding information in the event table will also be changed.

- The displayed decoded data information in the bus is related to the value of the horizontal time base. Reducing the horizontal time base can help you view the detailed information.

### Set the Event Table Format

In the Decode menu, click or tap the drop-down button of **Format** to select the display format of the event table. The available options include "**Hex**", "**Dec**", "**Bin**", and "**ASCII**".

### Export

When the oscilloscope is in STOP state, you can export the time and its corresponding decoded data in the event table.

In Decode menu, click or tap **Export**, then the save setting interface is displayed. You can export the data to the internal memory or the external USB storage device (only when detected) in \*.csv format. For details, refer to *To Store and Load*.

## 19.2 RS232 Decoding

RS232 serial bus consists of the transmitting data line (TX) and the receiving data line (RX).

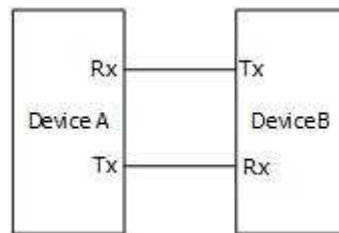

**Figure 19.4 Schematic Diagram of RS232 Serial Bus**

In RS232, baud rate is used to represent the transmission rate (namely bits per second) of the data. You need to set the start bit, data bits, check bit (optional), and stop bits for each frame of data.

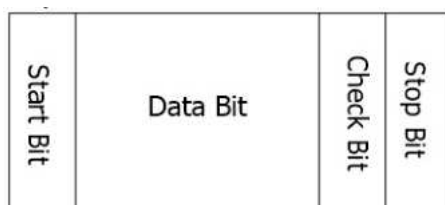

- **Start Bit:** indicates when to output data.
- **Data Bit:** indicates the number of data bits actually contained in each frame of data.
- **Check Bit:** used to check whether the data are properly transmitted.

- **Stop Bit:** indicates when to stop outputting data.

In the **Decode** menu, click or tap the drop-down button of **Bus Type** to select **RS232**, then configure the parameters for RS232 decoding.

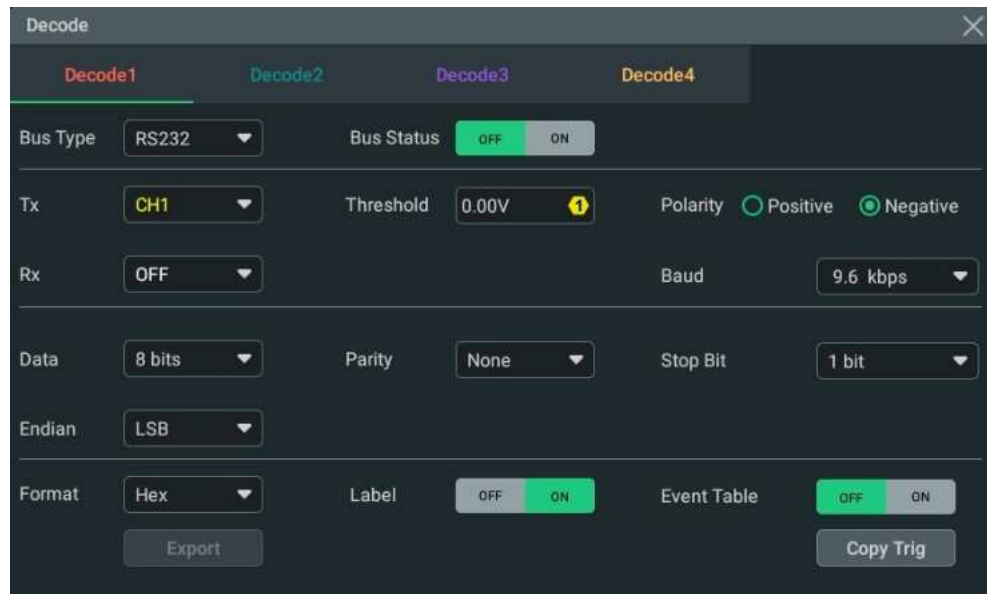

Figure 19.5 RS232 Decoding Menu

### Bus Status

Click or tap the **Bus Status** on/off switch to enable or disable the bus decoding.

### Quickly Apply Trigger Settings to Decoding

Copy trig indicates applying the trigger settings to the specified decoding setting.

Click or tap **Copy Trig** to apply the trigger settings to the specified decoding setting.

## 19.2.1 Source Setting

### Set the Tx source and the threshold

Click or tap the drop-down button of **Tx** to select the desired source. The options include analog channels, digital channels or OFF.

When the source is set to the analog channel, click or tap the input field of **Threshold**, and then use the pop-up numeric keypad to set the threshold of Tx source. You can also use the corresponding multifunction knob to set the value. The range of the threshold is related to the current vertical scale and offset.

When you modify the threshold of the Tx source channel, a dotted line displaying the current threshold level is displayed on the screen. It disappears in about 2 s after you stop modifying the threshold.

**NOTE**

For the supported channels of each model, refer to *Content Conventions in this Manual*

**Set the Rx source and the threshold**

Use the same method to select the **Rx** source and set the threshold. The default state of **Rx** is OFF.

**TIP**

The sources of **Tx** and **Rx** cannot be set to OFF at the same time.

**Polarity**

Click or tap "**Positive**" or "**Negative**" in **Polarity**.

- **Positive:** High level is logic "1" and low level is logic "0".
- **Negative:** High level is logic "0" and low level is logic "1".

**Set the baud rate**

Click or tap the drop-down button of **Baud** to select the baud rate. The available baud rates include 50 bps, 75 bps, 110 bps, 134 bps, 150 bps, and etc.

The oscilloscope allows you to self-define the baud rate. Click or tap the drop-down button of **Baud** to select "User" and then set the baud rate with the pop-up numeric keypad.

## 19.2.2 To Set Data Package

**Data**

Click or tap the drop-down button of **Data** to select the data bits. The available data bits are 5 bits, 6 bits, 7 bits, 8 bits, and 9 bits.

**Parity**

It is used to check whether the data transmission is correct. Click or tap the drop-down button of **Parity** to select the desired parity mode.

- **None:** indicates that no check bit appears during the transmission.
- **Even:** indicates that the total number of "1" in the data bit and check bit is an even number. For example, when 0x55 (01010101) is sent, "0" should be added to the check bit.
- **Odd:** indicates that the total number of "1" in the data bit and check bit is an odd number. For example, when 0x55 (01010101) is sent, "1" should be added to the check bit.

### Stop Bit

Click or tap the drop-down button of **Stop Bit** to set the stop bits after each frame of data. It can be set to 1 bit, 1.5 bits, or 2 bits.

### Endian

Click or tap the drop-down button of **Endian** to select the desired endian.

- **LSB:** indicates Least Significant Bit transmission sequence, i.e. the lowest bit of the data is transmitted first.
- **MSB:** indicates Most Significant Bit transmission sequence, i.e. the highest bit of the data is transmitted first.

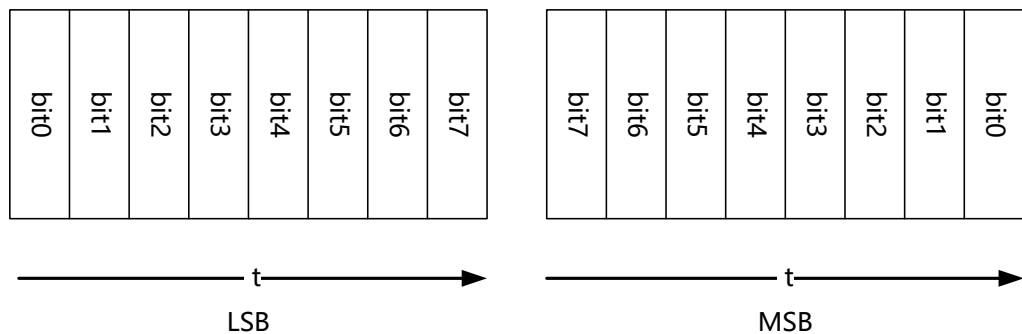

## 19.2.3 Display-related Setting

In the **Decode** menu, set the following display-related parameters.

### Set the Display Format

Click or tap the drop-down button of **Format** to select the display format of the bus data and the event table. The available formats include "**Hex**", "**Dec**", "**Bin**", and "**ASCII**".

### Set the Label Display

Click or tap the ON/OFF tab for **Label** to enable or disable the label display of the decoding bus. When enabled, the bus label will be displayed at the upper-left side of the bus (when the bus display is enabled). The label shows the current bus type.

## 19.2.4 Event Table

Click or tap the ON/OFF tab for **Event Table** to enable or disable the display of the event table. When enabled, the event table is displayed as shown in the figure below.

You can also click or tap the icon  at the upper-right corner of the table to close the event table.



Figure 19.6 RS232 Decoding Event Table



#### TIP

- When you adjust the horizontal time base, the waveform displayed on the screen will also change, and the total number of lines containing the decoding information in the event table will also be changed.
- The displayed decoded data information in the bus is related to the value of the horizontal time base. Reducing the horizontal time base can help you view the detailed information.

#### Set the Event Table Format

In the Decode menu, click or tap the drop-down button of **Format** to select the display format of the event table. The available options include "Hex", "Dec", "Bin", and "ASCII".

#### Export

When the oscilloscope is in STOP state, you can export the time and its corresponding decoded data in the event table.

In Decode menu, click or tap **Export**, then the save setting interface is displayed. You can export the data to the internal memory or the external USB storage device (only when detected) in \*.csv format. For details, refer to *To Store and Load*.

## 19.3 I2C Decoding

I2C serial bus consists of the clock line (SCL) and the data line (SDA).

**SCL:** samples SDA on the rising or falling edge of the clock.

**SDA:** indicates the data channel.

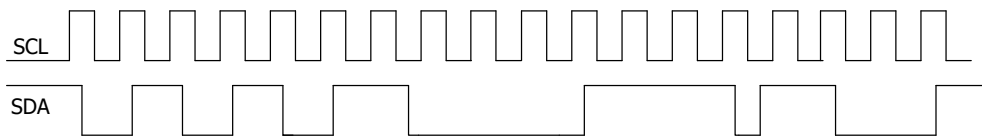

Figure 19.7 I2C Serial Bus

In the **Decode** menu, click or tap the drop-down button of **Bus Type** to select **I2C**, then configure the parameters for I2C decoding.

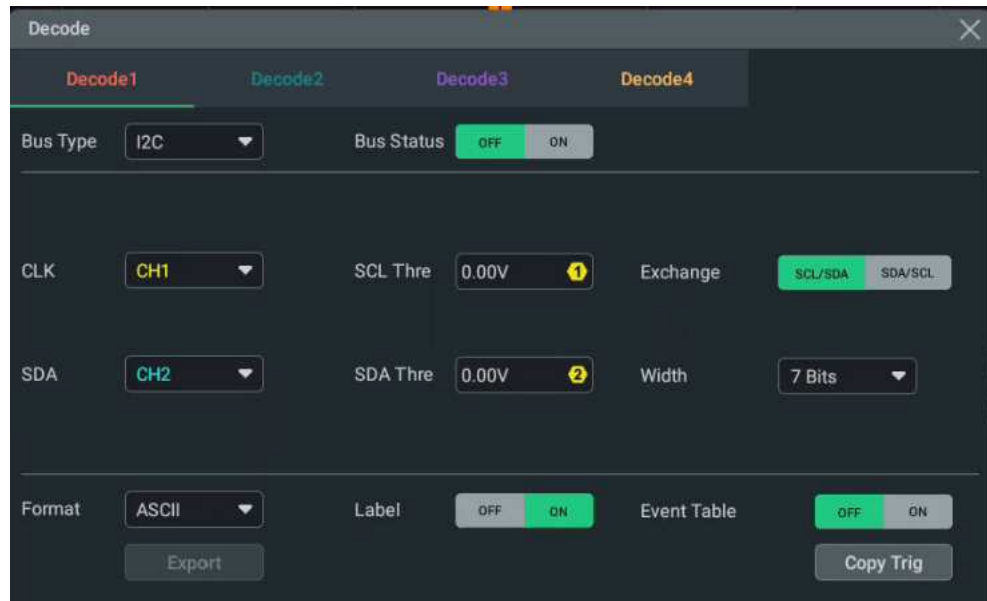

Figure 19.8 I2C Decoding Menu

### Bus Status

Click or tap the ON/OFF tab for **Bus Status** to enable or disable the bus decoding.

### Quickly Apply Trigger Settings to Decoding

Copy trig indicates applying the trigger settings to the specified decoding setting.

Click or tap **Copy Trig** to apply the trigger settings to the specified decoding setting.

## 19.3.1 Source Setting

### Set the Clock Channel and Data Channel

- You can select analog channels or digital channels as the source for **CLK**. When the source is set to the analog channel, set the **SCL Thre** value with the numeric keypad or multifunction knob.

When you modify the threshold of the clock channel, a dotted line displaying the current threshold level is displayed on the screen. It disappears in about 2 s after you stop modifying the threshold.

- You can select analog channels or digital channels as the source for **SDA**. When the source is set to the analog channel, set the **SDA Thre** with the numeric keypad or the multifunction knob.

For optional channel numbers of each model, refer to *Content Conventions in this Manual*.

### Exchange sources

Select "SCL/SDA" or "SDA/SCL" in **Exchange** to exchange the sources of the current clock channel and data channel.

### Set the Address Width

Click or tap the drop-down button of **Width** to select the address width. The available options include 7 Bits, 8 Bits, or 10 Bits. When "7 Bits" is selected, R/W bit is not included in the address. When "8 Bits" or "10 Bits" is selected, R/W bit is included in the address.

- 7:** In 7-bit addressing, after the START condition, a slave address is sent. The address starts to transfer from the first byte, as shown in the figure below. The first seven bits of the first byte make up the slave address, and the eighth bit is the LSB (least significant bit) which determines the direction of the message, also called a data direction bit (R/W). A "zero" indicates a transmission (WRITE), a "one" indicates a request for data (READ).

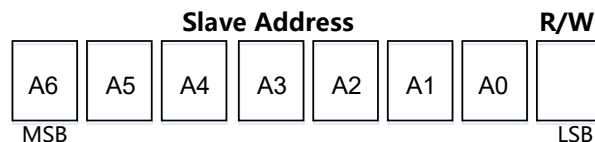

- 8:** same as the 7-bit addressing. A R/W bit is included in the 8-bit addressing for the slave address.
- 10:** 10-bit addressing is compatible with 7-bit addressing. As shown in the figure below, in 10-bit addressing, the first byte is the special reserved address 10-bit Address Indicator to indicate the current 10-bit address that is transferring.

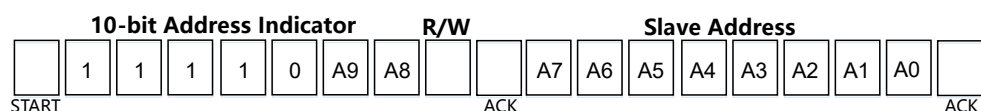

## 19.3.2 Display-related Setting

In the **Decode** menu, set the following display-related parameters.

### Set the Display Format

Click or tap the drop-down button of **Format** to select the display format of the bus data and the event table. The available formats include "Hex", "Dec", "Bin", and "ASCII".

### Set the Label Display

Click or tap the ON/OFF tab for **Label** to enable or disable the label display of the decoding bus. When enabled, the bus label will be displayed at the upper-left side of the bus (when the bus display is enabled). The label shows the current bus type.

## 19.3.3 Event Table

### Open or Close the Event Table

Click or tap the ON/OFF tab for **Event Table** to enable or disable the display of the event table. When enabled, the event table is displayed as shown in the figure below.

You can also click or tap the icon  at the upper-right corner of the table to close the event table.

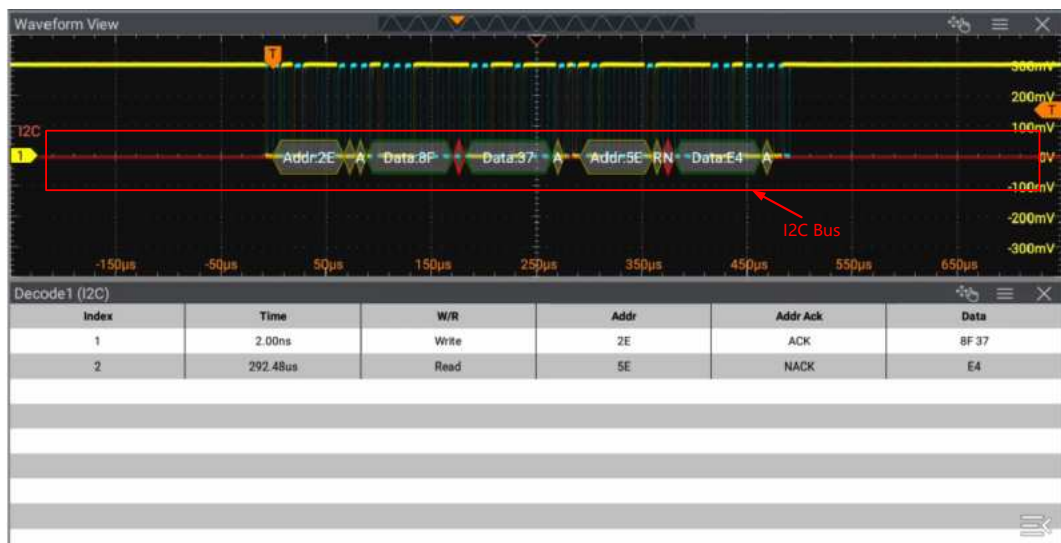

Figure 19.9 I2C Decoding Event Table



### TIP

- When you adjust the horizontal time base, the waveform displayed on the screen will also change, and the total number of lines containing the decoding information in the event table will also be changed.
- The displayed decoded data information in the bus is related to the value of the horizontal time base. Reducing the horizontal time base can help you view the detailed information.

### Set the Event Table Format

In the Decode menu, click or tap the drop-down button of **Format** to select the display format of the event table. The available options include "Hex", "Dec", "Bin", and "ASCII".

### Export



When the oscilloscope is in STOP state, you can export the time and its corresponding decoded data in the event table.

In Decode menu, click or tap **Export**, then the save setting interface is displayed. You can export the data to the internal memory or the external USB storage device (only when detected) in \*.csv format. For details, refer to *To Store and Load*.

### Address information in decoding

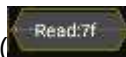
For I2C bus, each frame of data starts with the address information (read address and write address). In the address information, "Read" indicates the read address



() and "Write" indicates the write address () . You can decide whether to include or exclude the "R/W" bit for the address information.

### Error expressions in decoding

In I2C decoding, the response includes ACK (acknowledgment) and NACK (non-acknowledgment). When NACK is detected after "Write", red error report information



() is displayed.

## 19.4 SPI Decoding

SPI bus is based on the master— slave configuration and usually consists of chip select line (CS), clock line (CLK), and data line (SDA). Wherein, the data lines include the master input/slave output (MISO) data line and master output/slave input (MOSI) data line. The oscilloscope samples the channel data on the rising edge or falling edge of the clock signal and judges each data point (logic "1" or logic "0") according to the preset threshold level.

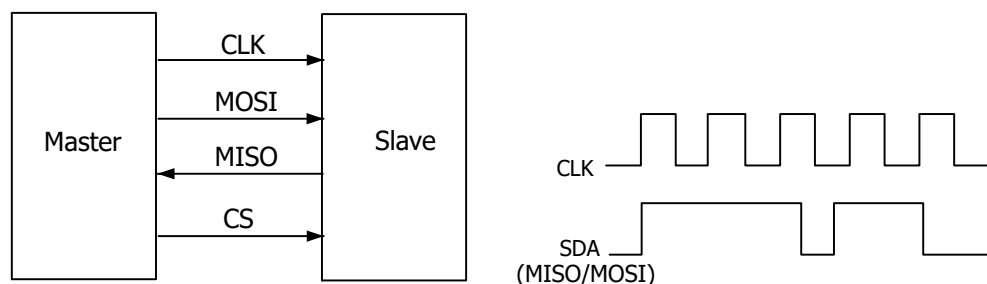

Figure 19.10 SPI Serial Bus

In the **Decode** menu, click or tap the drop-down button of **Bus Type** to select **SPI**, then configure the parameters for SPI decoding.

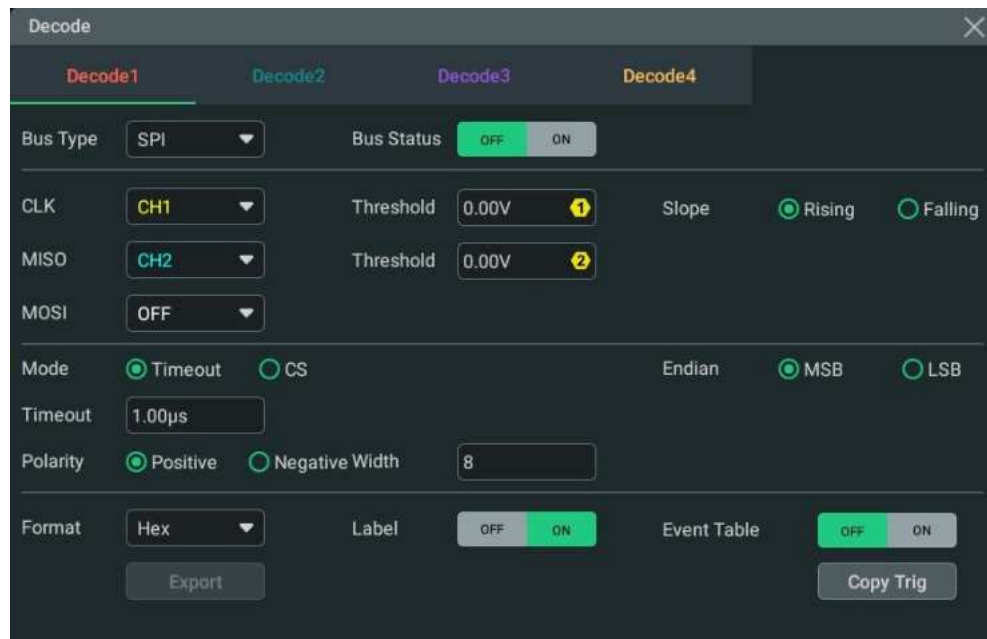

Figure 19.11 SPI Decoding Menu

### Bus Status

Click or tap the **Bus Status** on/off switch to enable or disable the bus decoding.

### Quickly Apply Trigger Settings to Decoding

Copy trig indicates applying the trigger settings to the specified decoding setting.

Click or tap **Copy Trig** to apply the trigger settings to the specified decoding setting.

## 19.4.1 Source Setting

### Set the Clock Signal

- Click or tap the drop-down button of **CLK** to select the analog channels or digital channels as the desired source.
- When the source is set to the analog channel, click or tap the input field of the **Threshold** to set the value with the pop-up numeric keypad. You can also use the corresponding multifunction knob to set the value.
- Click or tap "**Rising**" or "**Falling**" under **Slope** to set the instrument to sample MISO and MOSI on the CLK.

### MISO and MOSI Setting

- You can select the analog channels, digital channels or OFF as the desired source of **MISO**.

When the MISO source is set to the analog channel, you can set the **Threshold** for the MISO source channel with the numeric keypad or the multifunction knob.

- You can select the analog channels, digital channels or OFF as the desired source of **MOSI**.

When the MOSI source is set to the analog channel, you can set the **Threshold** for the MOSI source channel with the numeric keypad or the multifunction knob.



#### NOTE

The MISO and MOSI sources cannot be set to "OFF" at the same time.

For the supported channels of each model, refer to *Content Conventions in this Manual*

## 19.4.2 To Set the Mode and Data

### Mode

Select "**Timeout**" or "**CS**" in **Mode**.

- Timeout**

You can perform frame synchronization according to the timeout, and the timeout value must be greater than half of the clock cycle. Click or tap the input field of **Timeout**, and then use the pop-up numeric keypad to set the timeout value. You can also use the corresponding multifunction knob to set the value. The adjustable range of the timeout value is from 8 ns to 10 s. By default, it is 1  $\mu$ s.

- CS**

It contains a chip select line (CS). You can perform frame synchronization according to CS. When "CS" is selected,

- Click or tap the drop-down button of **CS** to select the desired source. You can select analog channels or digital channels.



#### NOTE

For the supported channels of each model, refer to *Content Conventions in this Manual*

- Click or tap the input field of the **Threshold** to set the threshold with the pop-up numeric keypad. You can also use the corresponding multifunction knob to set the threshold.
- In **CS Polarity**, select "**Positive**" or "**Negative**".

### Endian

Click or tap the drop-down button of **Endian** to select the desired endian.

- **LSB:** indicates Least Significant Bit transmission sequence, i.e. the lowest bit of the data is transmitted first.
- **MSB:** indicates Most Significant Bit transmission sequence, i.e. the highest bit of the data is transmitted first.

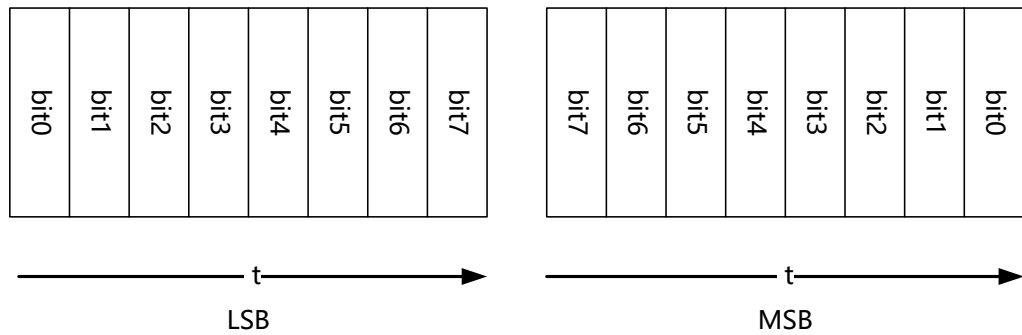

### Polarity

In **Polarity**, select "**Positive**" or "**Negative**".

### Width Setting

Click or tap the input field of **Width**, and then use the pop-up numeric keypad to set the bits of each frame of data. You can also use the corresponding multifunction knob to set the value. The setting range is from 4 to 32. By default, it is 8.

## 19.4.3 Display-related Setting

In the **Decode** menu, set the following display-related parameters.

### Set the Display Format

Click or tap the drop-down button of **Format** to select the display format of the bus data and the event table. The available formats include "**Hex**", "**Dec**", "**Bin**", and "**ASCII**".

### Set the Label Display

Click or tap the ON/OFF tab for **Label** to enable or disable the label display of the decoding bus. When enabled, the bus label will be displayed at the upper-left side of the bus (when the bus display is enabled). The label shows the current bus type.

## 19.4.4 Event Table

### Open or Close the Event Table

Click or tap the ON/OFF tab for **Event Table** to enable or disable the display of the event table. When enabled, the event table is displayed as shown in the figure below.

You can also click or tap the icon  at the upper-right corner of the table to close the event table.



Figure 19.12 SPI Decoding Event Table



### TIP

- When you adjust the horizontal time base, the waveform displayed on the screen will also change, and the total number of lines containing the decoding information in the event table will also be changed.
- The displayed decoded data information in the bus is related to the value of the horizontal time base. Reducing the horizontal time base can help you view the detailed information.

### Set the Event Table Format

In the Decode menu, click or tap the drop-down button of **Format** to select the display format of the event table. The available options include "Hex", "Dec", "Bin", and "ASCII".

## Export

When the oscilloscope is in STOP state, you can export the time and its corresponding decoded data in the event table.

In Decode menu, click or tap **Export**, then the save setting interface is displayed. You can export the data to the internal memory or the external USB storage device (only when detected) in \*.csv format. For details, refer to *To Store and Load*.

## 19.5 CAN Decoding (Option)

The oscilloscope samples the CAN or CAN-FD (option) signal at the specified sample position, and judges each data point to be logic "1" or logic "0" according to the preset threshold level. You need to specify the CAN or CAN-FD (option) signal type and sample position.

In the **Decode** menu, click or tap the drop-down button of **Bus Type** to select **CAN**, then configure the parameters for CAN decoding. The **CAN-FD Baud** and **FD Sample Position** items are available only when the CAN-FD option is installed and enabled. The CAN-FD Baud item specifies the baud rate of the CAN-FD bus.

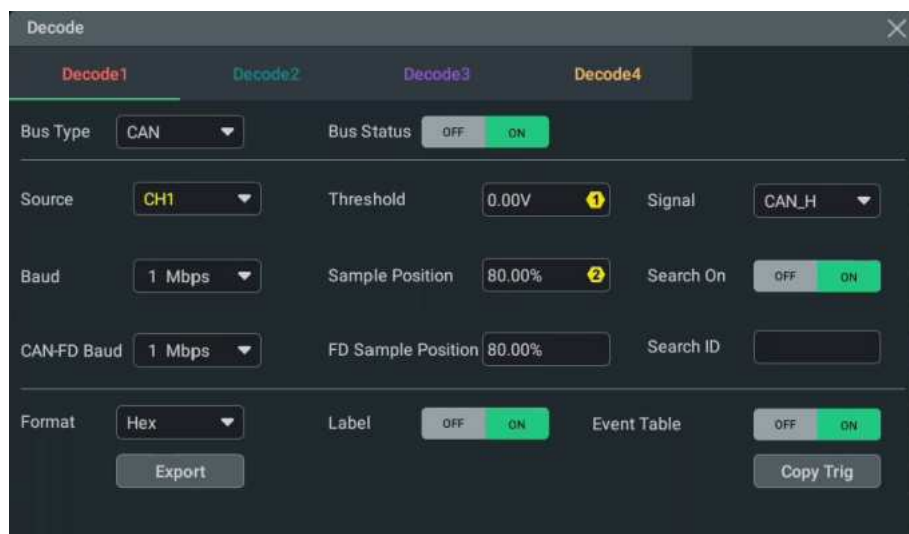

Figure 19.13 CAN Decoding Menu

### Bus Status

Click or tap the ON/OFF tab for **Bus Status** to enable or disable the bus decoding.

### Quickly Apply Trigger Settings to Decoding

Copy trig indicates applying the trigger settings to the specified decoding setting.

Click or tap **Copy Trig** to apply the trigger settings to the specified decoding setting.

## 19.5.1 Signal Configuration

### Set the Source and the Threshold

- Click or tap the drop-down button of **Source** to select the analog channel, digital channel or Math1-Math4 as the desired source. For the supported channels of each model refer to *Content Conventions in this Manual*.
- When the signal source is set to the analog channel or Math1-Math4, you can configure the **Threshold** with the pop-up numeric keypad. You can also use the corresponding multifunction knob to set the threshold.

When you modify the threshold of the signal source, a dotted line displaying the current threshold level is displayed on the screen. It disappears in about 2 s after you stop modifying the threshold.

### Select the Signal Type

Click or tap the drop-down button of **Signal** to select a signal type that matches the CAN bus signal. The available signal types include CAN\_H, CAN\_L, Rx, Tx, and Diff.

- **CAN\_H**: indicates the actual CAN\_H bus signal.
- **CAN\_L**: indicates the actual CAN\_L bus signal.
- **Rx**: indicates the Receive signal from the CAN bus transceiver.
- **Tx**: indicates the Transmit signal from the CAN bus transceiver.
- **DIFF**: indicates the CAN differential bus signals connected to an signal source channel by using a differential probe. Connect the probe's positive lead to the CAN\_H bus signal and connect the negative lead to the CAN\_L bus signal.

### Specify the Standard Signal Rate

Click or tap the drop-down button of **Baud** to select the preset baud rate. The available baud rates include 10.0 kbps, 19.2 kbps, 20.0 kbps, 33.3 kbps and etc.

### Sample Position

Sample position is a point within a bit's time. The oscilloscope samples the bit level at this point. The sample position is represented by the proportion of "the time from the start of the bit to the sample point" to the "bit time", as shown in the figure below.

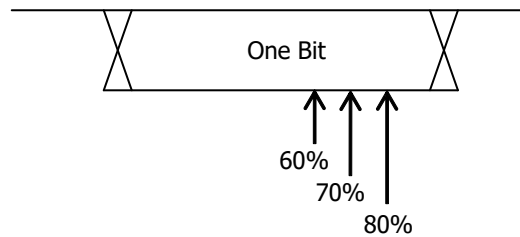

**Figure 19.14 Sample Position**

Click or tap the input field of **Sample Position** to set it by using the pop-up numeric keypad. You can also use the corresponding multifunction knob to set the value. The settable range is from 10% to 90%.

### Set the CAN-FD Baud

CAN-FD baud rate is a dedicated setting for the CAN-FD decoding. It is available only when the CAN-FD option is installed. Click or tap the drop-down button of **CAN-FD Baud** to select the variable baud rate from the drop-down list. The available baud rates include 1 Mbps, 2 Mbps, 3 Mbps, 4 Mbps, and etc.

### FD Sample Position

FD sample position is a dedicated setting for the CAN-FD decoding. It is available only when the CAN-FD option is installed. Click or tap the **FD Sample Position** input field and use the pop-up numeric keypad to set the value. You can also use the corresponding multifunction knob to set the value. The settable range is from 10% to 90%.

## 19.5.2 Display-related Setting

In the **Decode** menu, set the following display-related parameters.

### Set the Display Format

Click or tap the drop-down button of **Format** to select the display format of the bus data and the event table. The available formats include "Hex", "Dec", "Bin", and "ASCII".

### Set the Label Display

Click or tap the ON/OFF tab for **Label** to enable or disable the label display of the decoding bus. When enabled, the bus label will be displayed at the upper-left side of the bus (when the bus display is enabled). The label shows the current bus type.

## 19.5.3 Event Table

### Open or Close the Event Table

Click or tap the ON/OFF tab for **Event Table** to enable or disable the display of the event table. When enabled, the following event table as shown below is displayed.

You can also click or tap the icon  at the upper-right corner of the table to close the event table.

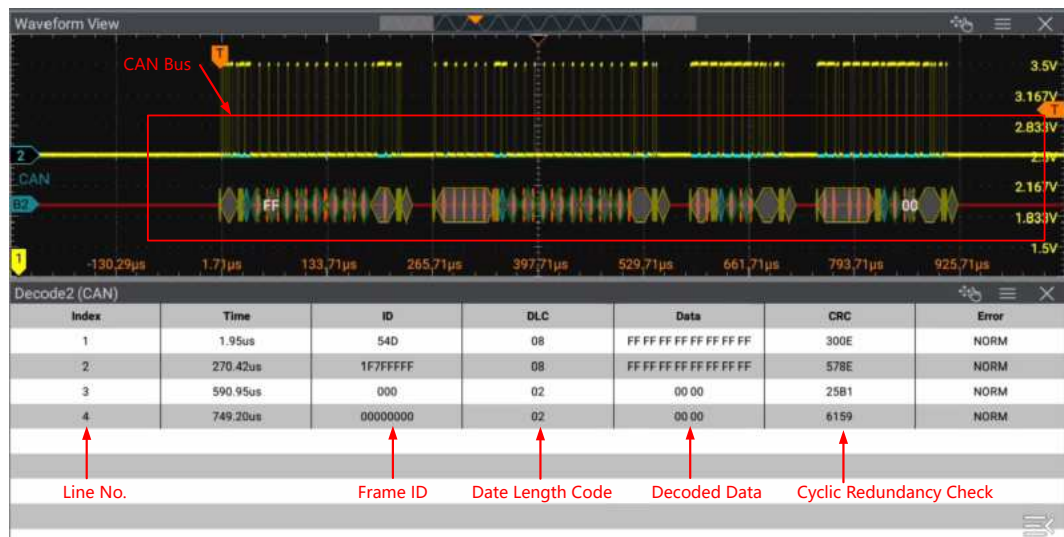

Figure 19.15 CAN Decoding Event Table



### TIP

- When you adjust the horizontal time base, the waveform displayed on the screen will also change, and the total number of lines containing the decoding information in the event table will also be changed.
- The displayed decoded data information in the bus is related to the value of the horizontal time base. Reducing the horizontal time base can help you view the detailed information.

### Search ID

When the event table is enabled and the operating status of the oscilloscope is STOP (stopping acquisition), you can search for the event with the specified ID from the current event table. When you enable "Search On" and input the specified search ID, the event table will only display the event with specified ID.

### Set the Event Table Format

In the Decode menu, click or tap the drop-down button of **Format** to select the display format of the event table. The available options include "Hex", "Dec", "Bin", and "ASCII".

## Export

When the oscilloscope is in STOP state, you can export the time and its corresponding decoded data in the event table.

In Decode menu, click or tap **Export**, then the save setting interface is displayed. You can export the data to the internal memory or the external USB storage device (only when detected) in \*.csv format. For details, refer to *To Store and Load*.

## Interpret the Decoded CAN Data

- Frame ID: expressed in Hex, identified as "ID:".
- DLC (Data Length Code): expressed in Hex, identified as "DLC:".
- Data: Its display format is the same as that of the bus data (Hex, Dec, Bin, or ASCII), identified as "Data:".
- CRC (Cyclic Redundancy Check): expressed in Hex, identified as "CRC:".
- ACK (Acknowledgement): identified as "ACK". When errors (ACK is detected to be 1) occur, displayed as a red patch.
- R (remote frame): identified as "R:".
- Stuff (Bit filling error): identified as "Stuff".

## 19.6 LIN Decoding (Option)

The oscilloscope samples the LIN signal, and judges each data point to be logic "1" or logic "0" according to the preset threshold level. The LIN decoding is required to specify the LIN signal protocol version.

In the **Decode** menu, click or tap the drop-down button of **Bus Type** to select **LIN**, then configure the parameters for LIN decoding.

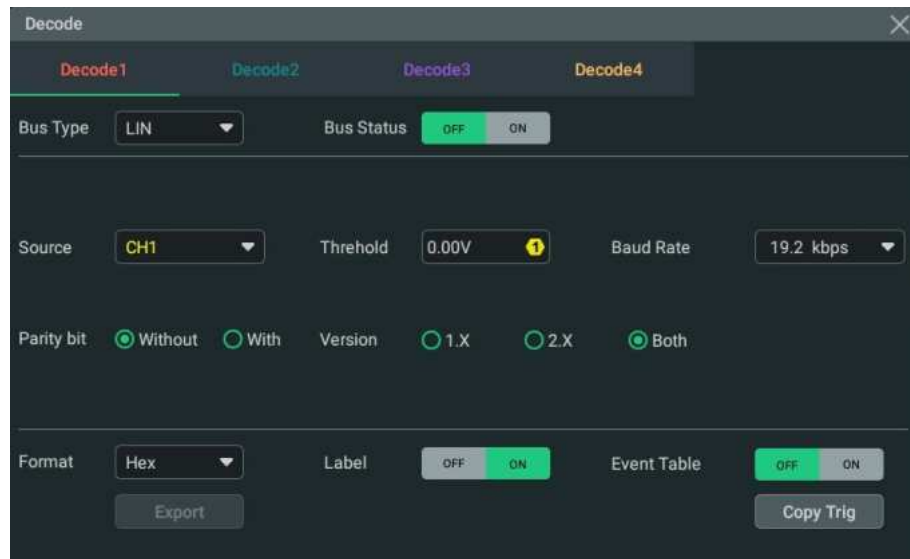

Figure 19.16 LIN Decoding Menu

### Bus Status

Click or tap the ON/OFF tab for **Bus Status** to enable or disable the bus decoding.

### Quickly Apply Trigger Settings to Decoding

Copy trig indicates applying the trigger settings to the specified decoding setting.

Click or tap **Copy Trig** to apply the trigger settings to the specified decoding setting.

## 19.6.1 Signal Configuration

### Set the Source and the Threshold

- Click or tap the drop-down button of **Source** to select the analog channels or digital channels as the desired source. For optional channel numbers of each model, refer to *Content Conventions in this Manual*.
- When the source is set to the analog channel, click or tap the input field of the **Threshold** to set the threshold with the pop-up numeric keypad. You can also use the corresponding multifunction knob to set the threshold.

When you modify the threshold of the signal source, a dotted line displaying the current threshold level is displayed on the screen. It disappears in about 2 s after you stop modifying the threshold.

### Set the Signal

- Click or tap the drop-down button of **Baud Rate** to select the baud rate. The available baud rates include 2.4 kbps, 4.8 kbps, 9.6 kbps, 10.0 kbps, 19.2 kbps, and etc. You can also self-define the baud rate.

- In **Parity bit**, click or tap **"With"** or **"Without"** to select whether the data contain the parity bit.
- In **Version**, select the protocol version that matches the LIN bus signal. The available versions include **"1.X"**, **"2.X"**, and **"Both"**.

### 19.6.2 Display-related Setting

In the **Decode** menu, set the following display-related parameters.

#### Set the Display Format

Click or tap the drop-down button of **Format** to select the display format of the bus data and the event table. The available formats include **"Hex"**, **"Dec"**, **"Bin"**, and **"ASCII"**.

#### Set the Label Display

Click or tap the ON/OFF tab for **Label** to enable or disable the label display of the decoding bus. When enabled, the bus label will be displayed at the upper-left side of the bus (when the bus display is enabled). The label shows the current bus type.

### 19.6.3 Event Table

#### Open or Close the Event Table

Click or tap the ON/OFF tab for **Event Table** to enable or disable the display of the event table. When enabled, the event table is displayed as shown in the figure below.

You can also click or tap the icon  at the upper-right corner of the table to close the event table.

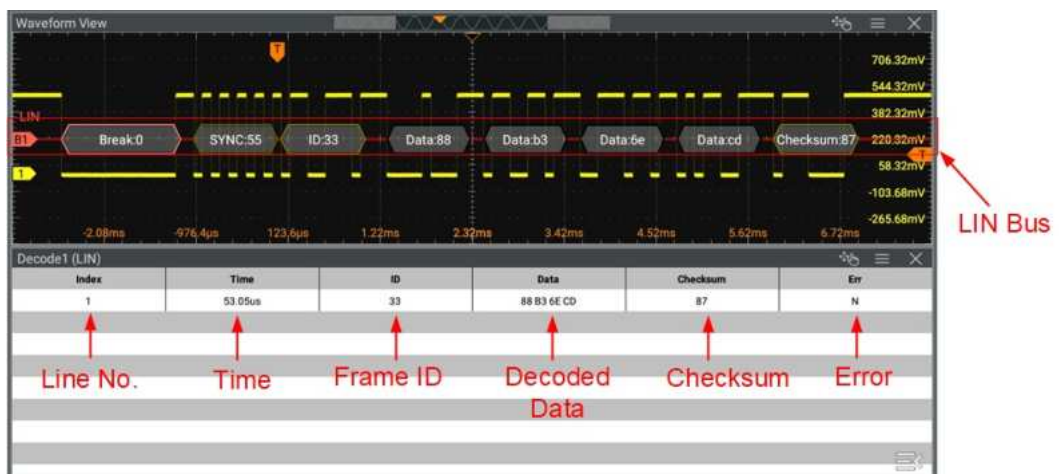

Figure 19.17 LIN Decoding Event Table

**TIP**

- When you adjust the horizontal time base, the waveform displayed on the screen will also change, and the total number of lines containing the decoding information in the event table will also be changed.
- The displayed decoded data information in the bus is related to the value of the horizontal time base. Reducing the horizontal time base can help you view the detailed information.

**Set the Event Table Format**

In the Decode menu, click or tap the drop-down button of **Format** to select the display format of the event table. The available options include **"Hex"**, **"Dec"**, **"Bin"**, and **"ASCII"**.

**Export**

When the oscilloscope is in STOP state, you can export the time and its corresponding decoded data in the event table.

In Decode menu, click or tap **Export**, then the save setting interface is displayed. You can export the data to the internal memory or the external USB storage device (only when detected) in \*.csv format. For details, refer to *To Store and Load*.

**Interpret the Decoded LIN Data**

- Break (Sync Break): expressed in Hex, identified as "Break:".
- SYNC (Sync): expressed in Hex, identified as "SYNC:".
- ID (Frame ID): expressed in Hex, identified as "ID:".
- Data (Data): Its display format is the same as that of the bus data (Hex, Dec, Bin, or ASCII), identified as "Data:".
- Checksum (check sum): expressed in Hex, identified as "Checksum:". When errors occur, it is displayed as a red patch.
- Wakeup (wake up symbol): identified as "Wakeup:".

## 19.7 I2S Decoding (Option)

The oscilloscope samples the I2S signal, and judges each data point to be logic "1" or logic "0" according to the preset threshold level. I2S decoding is required to specify the serial clock, channel signal, and the data's source channel. You need to set Alignment, WS Low, and other parameters.

In the **Decode** menu, click or tap the drop-down button of **Bus Type** to select **I2S**, then configure the parameters for I2S decoding.

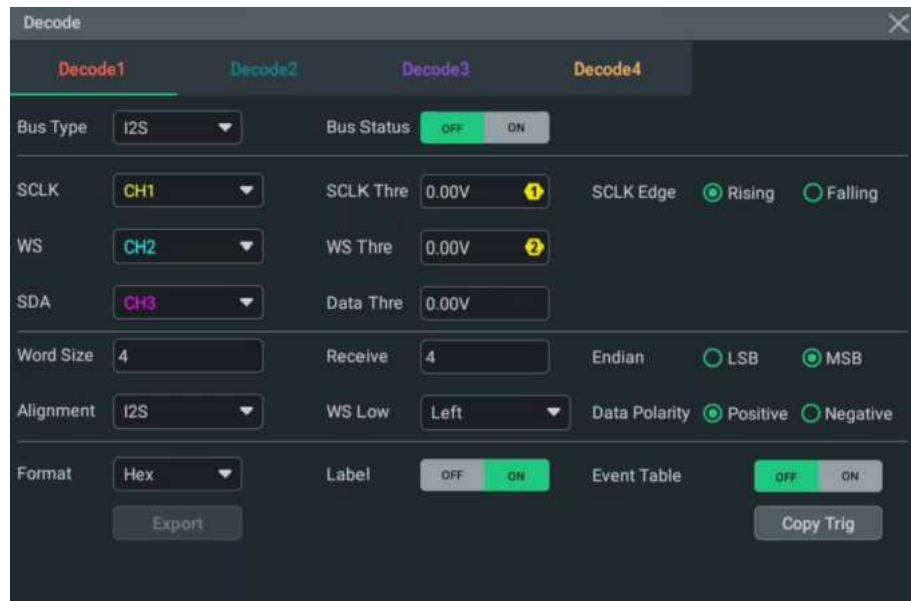

Figure 19.18 I2S Decoding Menu

### Bus Status

Click or tap the ON/OFF tab for **Bus Status** to enable/disable the bus decoding.

### Quickly Apply Trigger Settings to Decoding

Copy trig indicates applying the trigger settings to the specified decoding setting.

Click or tap **Copy Trig** to apply the trigger settings to the specified decoding setting.

## 19.7.1 Source Setting

### Set the SCLK Source and Threshold

- Click or tap the drop-down button of **SCLK** to select the analog channels or digital channels as the serial serial clock source.
- When the source is set to the analog channel, click or tap the input field of **Threshold** to set the threshold with the pop-up numeric keypad. You can also use multifunction knob to set the threshold. When you modify the threshold of the clock channel, a dotted line displaying the current threshold level is displayed on the screen. It disappears in about 2 s after you stop modifying the threshold.
- In **SCLK Edge** menu, click or tap to select "**Rising**" or "**Falling**" as the desired clock edge.

### Set the WS Source and Threshold

- Click or tap the drop-down button of **WS** to select the analog channels or digital channels as the WS source.

- Click or tap the input field of **WS Thre** to set the WS threshold with the pop-up numeric keypad. You can also use multifunction knob to set the WS threshold. When you modify the WS threshold, a dotted line displaying the current threshold level is displayed on the screen. It disappears in about 2 s after you stop modifying the threshold.

#### Set the SDA Source and Threshold

- Click or tap the drop-down button of **SDA** to select the analog channels or digital channels as the SDA source.
- Click or tap the input field of **Data Thre** to set the data threshold with the pop-up numeric keypad. You can also use multifunction knob to set the data threshold. When you modify the data threshold, a dotted line displaying the current threshold level is displayed on the screen. It disappears in about 2 s after you stop modifying the threshold.



#### NOTE

For the supported channels of each model, refer to *Content Conventions in this Manual*

## 19.7.2 Bus Setting

### Set the Word Size

You can use the pop-up numeric keypad to set **Word Size**. Its range is from 4 to 32. You can also use the specified knob indicated in the input field to set the value.

### Set the Receiver Word Size

You can use the pop-up numeric keypad to set **Receive**. Its range is from 4 to 32. Also, you can use the specified knob indicated in the input field to set the value.

### Set the Endian

In **Endian** menu, click or tap to select "**LSB**" or "**MSB**". By default, it is "MSB".

### Set the Alignment Mode

Click or tap the drop-down button of **Alignment** to select the alignment way for data signal. The available choices include "**I2S**", "**LJ**", and "**RJ**".

### Set the Audio Polarity

Click or tap the drop-down button of **WS Low** to select "**Left**" or "**Right**".

### Set the Data Polarity

In **Data Polarity** menu, click or tap to select "**Positive**" or "**Negative**".

## 19.7.3 Display-related Setting

In the **Decode** menu, set the following display-related parameters.

### Set the Display Format

Click or tap the drop-down button of **Format** to select the display format of the bus data and the event table. The available formats include "Hex", "Dec", "Bin", and "ASCII".

### Set the Label Display

Click or tap the ON/OFF tab for **Label** to enable or disable the label display of the decoding bus. When enabled, the bus label will be displayed at the upper-left side of the bus (when the bus display is enabled). The label shows the current bus type.

## 19.7.4 Event Table

When enabled the Event Table, the event table is displayed on the screen. The decoding information of the signal is displayed in the event table window.



Figure 19.19 I2S Decoding Event Table



### TIP

- When you adjust the horizontal time base, the waveform displayed on the screen will also change, and the total number of lines containing the decoding information in the event table will also be changed.
- The displayed decoded data information in the bus is related to the value of the horizontal time base. Reducing the horizontal time base can help you view the detailed information.

### Set the Event Table Format

In the Decode menu, click or tap the drop-down button of **Format** to select the display format of the event table. The available options include "Hex", "Dec", "Bin", and "ASCII".

### Export

When the oscilloscope is in STOP state, you can export the time and its corresponding decoded data in the event table.

In Decode menu, click or tap **Export**, then the save setting interface is displayed. You can export the data to the internal memory or the external USB storage device (only when detected) in \*.csv format. For details, refer to *To Store and Load*.

## 19.8 FlexRay Decoding (Option)

FlexRay is a type of differential serial bus configured with three consecutive segments (i.g. packet header, payload, and packet trailer). The oscilloscope samples the FlexRay signal at the specified sample position and judges each data point as logic "1" or logic "0" according to the preset threshold level. The FlexRay decoding is required to specify the signal type and baud rate.

In the **Decode** menu, click or tap the drop-down button of **Bus Type** to select **FlexRay**, then configure the parameters for FlexRay decoding.

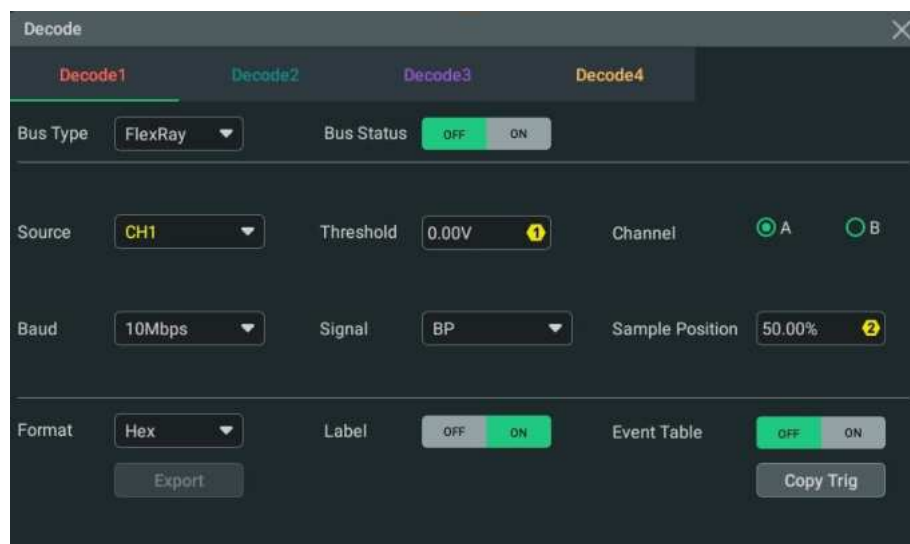

Figure 19.20 FlexRay Decoding Menu

### Bus Status

Click or tap the ON/OFF tab for **Bus Status** to enable/disable the bus decoding.

### Quickly Apply Trigger Settings to Decoding

Copy trig indicates applying the trigger settings to the specified decoding setting.

Click or tap **Copy Trig** to apply the trigger settings to the specified decoding setting.

## 19.8.1 Signal Configuration

### Set the Source and the Threshold

- Click or tap the drop-down button of **Source** to select the analog channels or digital channels as the desired source. For optional channel numbers of each model, refer to *Content Conventions in this Manual*.
- When the source is set to the analog channel, click or tap the input field of the **Threshold** to set the threshold with the pop-up numeric keypad. You can also use the corresponding multifunction knob to set the threshold.

When you modify the threshold of the signal source, a dotted line displaying the current threshold level is displayed on the screen. It disappears in about 2 s after you stop modifying the threshold.

### Select the Signal

Click or tap "A" or "B" in **Channel** to select a channel that matches the actual FlexRay bus signal.

### Specify the Signal Rate

Click or tap the drop-down button of **Baud** to select a FlexRay baud rate that matches the FlexRay bus signal. The available baud rates include "2.5 Mbps", "5 Mbps", and "10 Mbps".

### Set the Signal Type

Click or tap the drop-down button of **Signal** to select a signal type that matches the actual FlexRay bus signal. The available signal types include "BP", "BM", and "RX/TX".

### Sample Position

Sample position is a point within a bit's time. The oscilloscope samples the bit level at this point. The sample position is represented by the proportion of "the time from the start of the bit to the sample point" to the "bit time", as shown in the figure below.

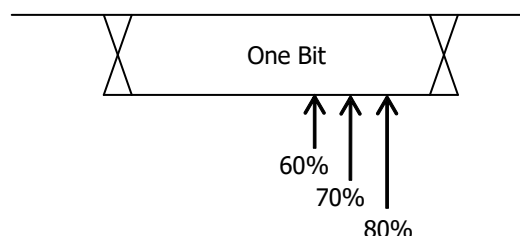

Figure 19.21 Sample Position

Click or tap the input field of **Sample Position** to set it by using the pop-up numeric keypad. You can also use the corresponding multifunction knob to set the value. The settable range is from 10% to 90%.

## 19.8.2 Display-related Setting

In the **Decode** menu, set the following display-related parameters.

### Set the Display Format

Click or tap the drop-down button of **Format** to select the display format of the bus data and the event table. The available formats include "Hex", "Dec", "Bin", and "ASCII".

### Set the Label Display

Click or tap the ON/OFF tab for **Label** to enable or disable the label display of the decoding bus. When enabled, the bus label will be displayed at the upper-left side of the bus (when the bus display is enabled). The label shows the current bus type.

## 19.8.3 Event Table

### Open or Close the Event Table

Click or tap the ON/OFF tab for **Event Table** to enable or disable the display of the event table. When enabled, the event table is displayed as shown in the figure below.

You can also click or tap the icon  at the upper-right corner of the table to close the event table.

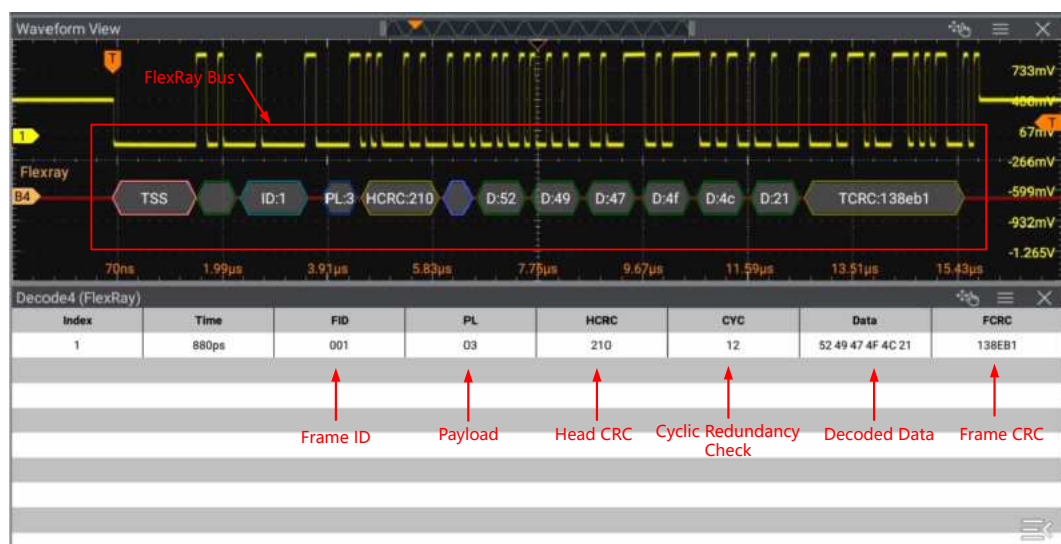

Figure 19.22 FlexRay Decoding Event Table

**TIP**

- When you adjust the horizontal time base, the waveform displayed on the screen will also change, and the total number of lines containing the decoding information in the event table will also be changed.
- The displayed decoded data information in the bus is related to the value of the horizontal time base. Reducing the horizontal time base can help you view the detailed information.

**Set the Event Table Format**

In the Decode menu, click or tap the drop-down button of **Format** to select the display format of the event table. The available options include "**Hex**", "**Dec**", "**Bin**", and "**ASCII**".

**Export**

When the oscilloscope is in STOP state, you can export the time and its corresponding decoded data in the event table.

In Decode menu, click or tap **Export**, then the save setting interface is displayed. You can export the data to the internal memory or the external USB storage device (only when detected) in \*.csv format. For details, refer to *To Store and Load*.

**Interpret the Decoded FlexRay Frame Data**

- TSS: transmission start sequence, identified as "TSS:".
- Sync Frame: identified as "SYNC:".
- ID (Frame ID): expressed in Hex, identified as "ID:".
- PL (Payload Length): expressed in Hex, identified as "PL:".
- HCRC (Header Cyclic Redundancy Check): expressed in Hex, identified as "HCRC:". When error occurs, it is displayed as a red patch.
- CYC (Cycle Number): expressed in Hex, identified as "CYC:".
- Data: Its display format is the same as that of the bus data (Hex, Dec, Bin, or ASCII), identified as "Data:".
- TCRC (Tail Cyclic Redundancy Check): expressed in Hex, identified as "TCRC:".

When error occurs, it is displayed as a red patch.

## 19.9 1553B Decoding (Option)

The oscilloscope samples the 1553B signal, and judges each data point to be logic "1" or logic "0" according to the preset threshold level. 1553B decoding is required to specify the data channel source and the threshold.

In the **Decode** menu, click or tap the drop-down button of **Bus Type** to select **1553B**, then configure the parameters for 1553B decoding.

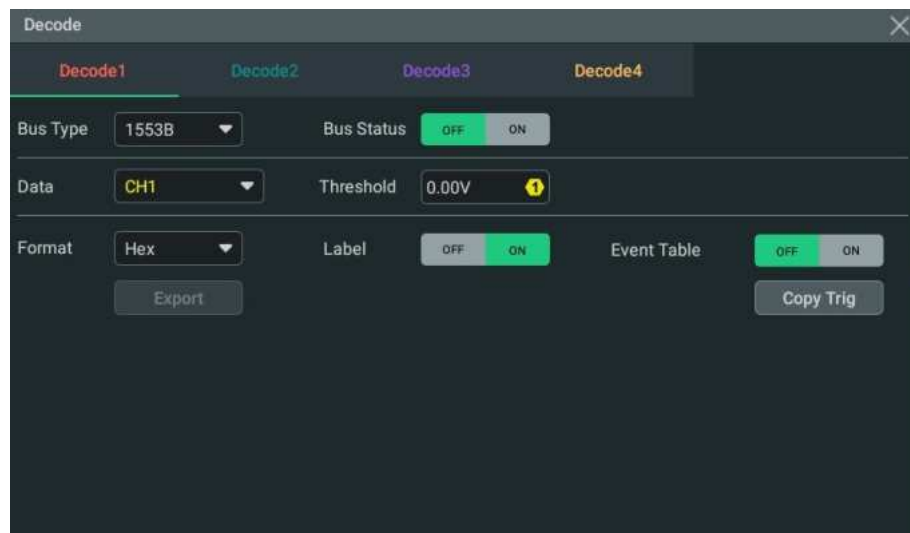

Figure 19.23 1553B Decoding Menu

### Bus Status

Click or tap the ON/OFF tab for **Bus Status** to enable/disable the bus decoding.

### Quickly Apply Trigger Settings to Decoding

Copy trig indicates applying the trigger settings to the specified decoding setting.

Click or tap **Copy Trig** to apply the trigger settings to the specified decoding setting.

## 19.9.1 To Set the Data Channel Source and the Threshold

### Select the Data Channel

You can select analog channels or digital channels as source for **SDA**. For the supported channels of each model refer to *Content Conventions in this Manual*.

### Set the Threshold

When the analog channel is set as the data channel source, you can configure the **Threshold** with the pop-up numeric keypad. You can also use the corresponding multifunction knob to set the threshold.

When you modify the threshold of the channel, a dotted line displaying the current threshold level is displayed on the screen. It disappears in about 2 s after you stop modifying the threshold.

## 19.9.2 Event Table

### Open or Close the Event Table

Click or tap the ON/OFF tab for **Event Table** to enable or disable the display of the event table. When enabled, the event table is displayed as shown in the figure below.

You can also click or tap the icon  at the upper-right corner of the table to close the event table.

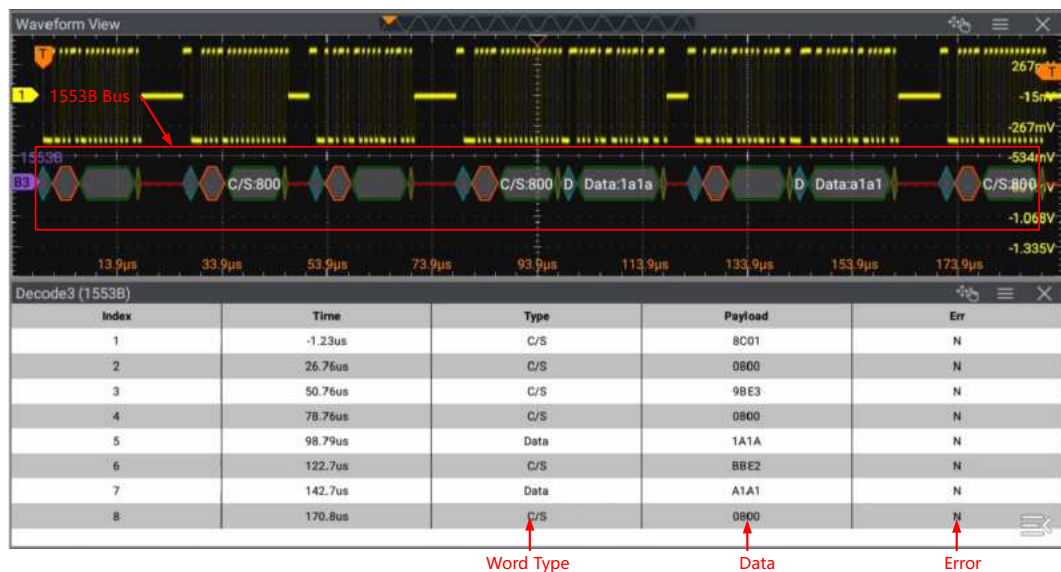

Figure 19.24 1553B Decoding Event Table

### TIP

- When you adjust the horizontal time base, the waveform displayed on the screen will also change, and the total number of lines containing the decoding information in the event table will also be changed.
- The displayed decoded data information in the bus is related to the value of the horizontal time base. Reducing the horizontal time base can help you view the detailed information.

### Set the Event Table Format

In the Decode menu, click or tap the drop-down button of **Format** to select the display format of the event table. The available options include "Hex", "Dec", "Bin", and "ASCII".



## Export

When the oscilloscope is in STOP state, you can export the time and its corresponding decoded data in the event table.

In Decode menu, click or tap **Export**, then the save setting interface is displayed. You can export the data to the internal memory or the external USB storage device (only when detected) in \*.csv format. For details, refer to *To Store and Load*.

### Interpret the Decoded 1553B Data

- C/S: command/status word. It is identified as "C/S".
- RTA: remote terminal address of the command/status word. It is identified as "RTA:".
- C/S data: the rest data value of the command/status word. Its display format is the same as that of the bus data (Hex, Dec, Bin, or ASCII), identified as "C/S:".
- Parity bit: displayed as a yellow-green patch; when errors occur, displayed as a red patch.
- Data word data: data of the data word. Its display format is the same as that of the bus data (Hex, Dec, Bin, or ASCII), identified as "Data:".

## 20 Multi-pane Windowing

This series oscilloscope supports multi-pane windowing. You can add multiple windows and result display windows for display and view.

Click or tap  > **Windows** to enter the "Add Window" menu. You can also click or tap the **Windows** button on the toolbar menu.

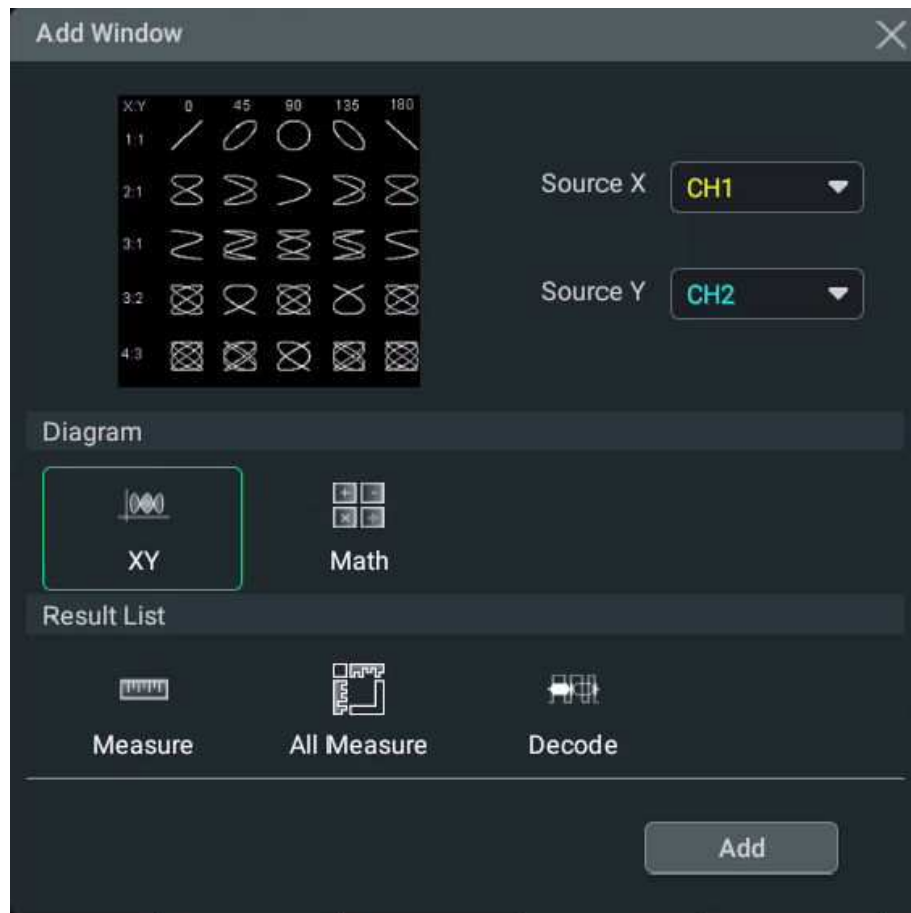

Figure 20.1 Add Window Menu

### Add Diagram Windows

1. First, select the desired waveform window in the **Diagram** menu, then you can preview the corresponding waveform and parameter settings at the top of the menu.
2. You can set parameters such as Source according to your needs. For details, refer to descriptions of relevant chapters.
3. Click or tap **Add** and then the selected diagram is displayed on the screen.



### Add Result List Window

Clip or tap **Measure**, **Measure All**, or **Decode** in the **Result List** menu to preview the corresponding measurement result list and parameter settings above the menu. Click or tap **Add**, the corresponding measurement results will be displayed on the screen.

## 21 Waveform Recording and Playing

Records the waveforms and plays back the recorded waveforms to make an analysis of the waveforms.

To enter the waveform recording menu, perform one of the following operations.

- Click or tap the function navigation icon  at the lower-left corner of the screen to open the function navigation menu. Click or tap to select **Record** to enter the waveform recording interface.
- Click or tap the **Record** icon on the quick operation toolbar to enter the waveform recording interface.
- Press  on the front panel, then the Analyse interface is displayed. Click or tap **Record** to enter the waveform recording interface.

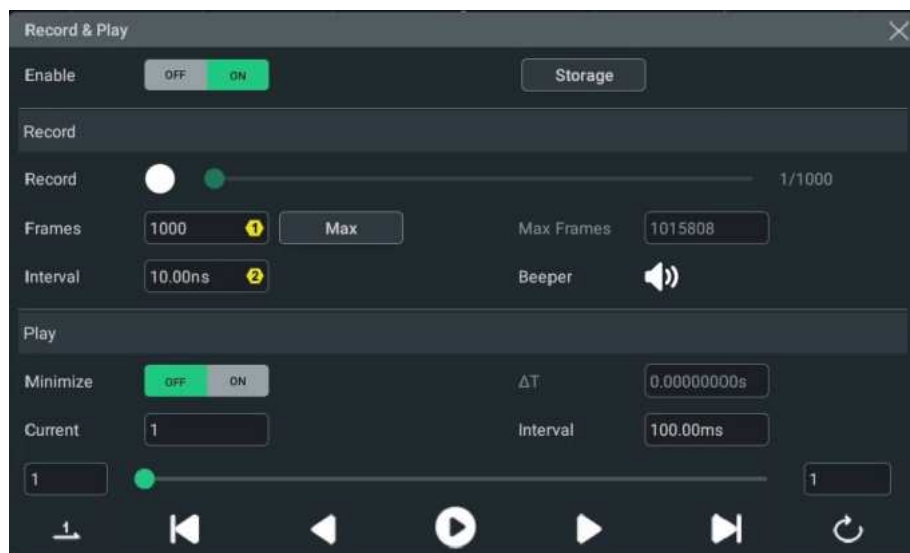





Figure 21.1 Waveform Recording Interface

### 21.1 Common Settings

#### Recording Operation





Click or tap the ON/OFF tab for the **Enable** menu in the Record & Play interface to enable or disable the waveform recording and playing function. Before recording the waveform, you can refer to descriptions in *Record Options* to set the waveform recording parameters.

- Click or tap the **Record** icon  to start recording the waveforms. Then the record icon turns from  to .

- The figure at the right side of the recording progress bar shows the number of currently recorded frames and the total number of frames that can be recorded (Number of Currently Recorded Frames/Total Number of Frames that can be Recorded). During the recording, the current recording information updates in a real-time manner on the screen, and the number of currently recorded frames changes constantly.
- After the recording is completed,  turns out to be  and recording stops automatically.
- During recording, you can also click or tap  to suspend recording manually.



### Play Operation

Click or tap the play icon  in the **Play** menu to start to play the recorded waveforms. The play icon turns from  to the pause action icon . For details about playing, refer to descriptions in *Play Options*. During waveform playing, the value of **Current** changes dynamically. During playing, you can also click or tap the icon  again to suspend playing manually.  $\Delta T$  indicates the time interval between the current frame played and the first frame.

### Storage

Click or tap **Storage**, then it goes to the storage interface. For the detailed operation, refer to descriptions in *To Save Wave* to save the recorded waveforms based on the settings.

## 21.2 Record Options

During the waveform recording, the oscilloscope records the waveforms of the currently enabled channel at a specified interval until you manually stops the recording operation or the number of recorded frames has reached the set value.

Before recording the waveforms, set the following parameters.

### 1. Interval

Indicates the time interval between the frames during the recording process.

Click or tap the input field of **Interval** to set the interval between frames with the pop-up numeric keypad. You can also rotate the specified multifunction knob indicated in the field to set the value. The available range is from 10 ns to 1 s.

## 2. Frames

Indicate the number of frames that can be recorded actually. After starting the recording operation, the oscilloscope will stop the recording operation automatically when the number of recorded frames reaches the set value.

Click or tap **Frames** to set the number of frames that can be recorded with the pop-up numeric keypad. You can also rotate the specified multifunction knob indicated in the field to set the value. The available range is from 1 to the maximum number of frames that can be recorded currently.

## 3. Max Frames

Indicates the maximum number of frames that can be recorded. Click or tap **Max** which is at the right of the field of **Frames**, and the maximum number of recorded waveform frames is automatically input into the input field of **Frames**.

As the capacity of the waveform memory is fixed, the more the number of points each frame of waveform has, the less the number of waveform frames that can be recorded. Therefore, the maximum number of recorded frames is related to the currently selected "memory depth" (refer to *Memory Depth*). The number of points per frame of waveform refers to the current memory depth.  $\text{Memory Depth} \geq \text{Sample Rate} \times \text{Horizontal Time Base} \times \text{Number of Grids in the Horizontal Direction on the Screen}$ . Therefore, the Max Frames value of waveform recording is also related to the "Sample Rate" and "Horizontal Time Base".

## 4. Beeper

Sets whether to enable the beeper after the recording process is completed. : the beeper sounds after recording is completed.

: the beeper does not sound after recording is completed.

## 21.3 Play Options

Play back the waveforms currently recorded. In the **Play** section, click or tap the ON/OFF tab for the **Minimize** menu to select whether to minimize the Play operation window. If you select **ON**, the play operation window is minimized, making the interface simple, distinctive, and easy to use, as shown in the figure below.

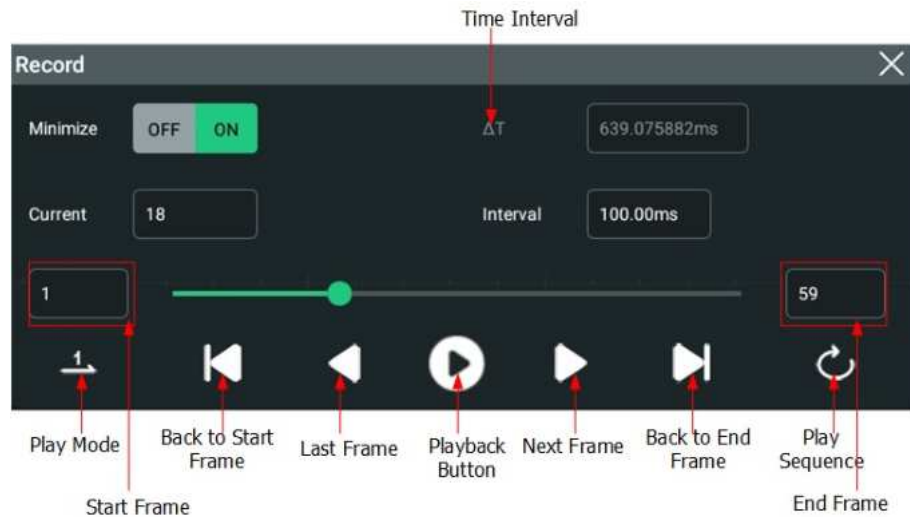

**Figure 21.2 Play Operation Interface**

Before playing the waveforms, set the following parameters.

### 1. Play Mode

Plays the waveforms in single mode (👉) or cycle mode (🔄). Click or tap the first icon at the bottom of the Play option menu to switch the play mode.

- 👉: plays from the start frame to the end frame, and then stops automatically.
- 🔄: plays from the start frame to the end frame, then such playback operation is repeated until you stop it manually.

### 2. Playback Sequence

Plays back the waveforms clockwise (🕒) or counterclockwise (🕒). Click or tap the last icon at the bottom of the Play option menu to switch the playback sequence.

- 🕒: plays from the start frame to the end frame.
- 🕒: plays from the end frame to the start frame.

### 3. Interval

Indicates the time interval between the frames during the playing process.

Click or tap the input field of **Interval** to set the interval between frames with the pop-up numeric keypad. You can also rotate the specified multifunction knob indicated in the field to set the value. The available range is from 1 ms to 1 s.

#### 4. Start Frame

Click or tap the input field of "Start Frame" shown in *Figure 21.2* to set the start frame of playback with the pop-up numeric keypad. You can also rotate the specified multifunction knob indicated in the field to set the value. The default is 1, and the maximum value is the maximum number of waveform frames that have been recorded.

#### 5. End Frame

Click or tap the input field of "End Frame" shown in *Figure 21.2* to set the end frame of playback with the pop-up numeric keypad. You can also rotate the specified multifunction knob indicated in the field to set the value. The default value is the number of waveform frames that have been recorded.

#### 6. Current Frame

When stopping playing back, click or tap the input field of **Current** shown in *Figure 21.2* to set the currently displayed frame with the pop-up numeric keypad. You can also rotate the specified multifunction knob indicated in the field to set the value. The max. value for the current frame is the max. number of frames that have been recorded.

## 22 Search and Navigation Function

The search function can help you quickly locate the concerned events and make a mark. Then, you can use the specific navigation arrow keys to quickly locate the specified event, time, or frame segment (currently unavailable). The search type can be set to Edge or Pulse.

The navigation function guides users to quickly locate and view the specified waveforms. You can navigate by time and event.

### 22.1 Search Function

The search function allows you to search the specified Edge or Pulse event, then marks it with an upside-down triangle icon (▼). To enter the search interface, click or tap the function navigation icon at the lower-left corner of the screen , then click or tap **Search**. You can also click or tap the **Navigate** icon on the quick operation toolbar to enter the navigation interface, then click or tap **Search** to go to the search interface.

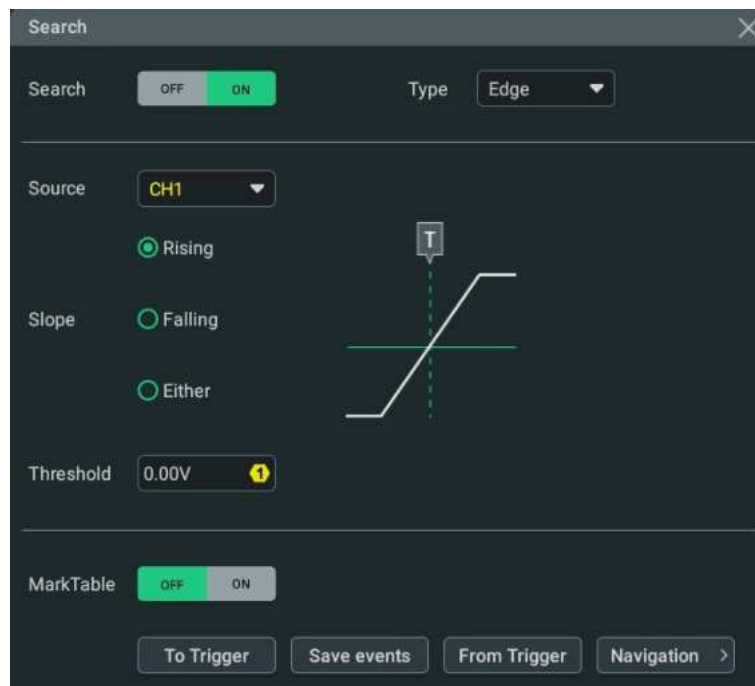

Figure 22.1 Search Menu

#### 1. Enable or disable the search function

Click or tap the ON/OFF tab for the **Search** menu to enable or disable the search function.

**TIP**

When the search function is enabled, *Zoom Mode (Delayed Sweep)* is automatically enabled.

**2. Select the search type and set the parameters**

Click or tap the drop-down button of **Type** to select the desired search type (Edge or Pulse). Click or tap the drop-down button of **Source** to select the desired source from the drop-down list.

- **Edge search:** when the search type is set to "Edge", you can set the edge type to "Rising", "Falling", or "Either". For details about the edge type settings, refer to descriptions in *Edge Trigger*. Click or tap the input field of **Threshold** to set the threshold with the pop-up numeric keypad. You can also use the specified knob indicated in the input field to set it.
- **Pulse search:** when the search type is set to "Pulse", you can set the pulse search condition. For details about the settings, refer to descriptions in *Pulse Trigger*. Click or tap the input field of **Threshold** to set the threshold with the pop-up numeric keypad. You can also use the specified knob indicated in the input field to set it.

**3. Copy Trigger****- Copy to Trigger**

Click or tap **To Trigger** to copy the selected search type settings to the same trigger type. For example, if the current search type is "Edge", click or tap **To Trigger** to copy the edge search settings to the "*Edge Trigger*" settings.

**- Copy from Trigger**

Click or tap **From Trigger** to copy the trigger settings of the selected search type to the search settings. For example, if the current trigger type is "*Edge Trigger*", click or tap **From Trigger** to copy the Edge trigger settings to the "Edge" search settings.



**NOTE**

If you select "From Trigger", you need to set the search type first, and then copy the trigger type settings from the trigger menu.

**4. Enable or disable the marker table**

Click or tap the ON/OFF tab for **MarkTable** to enable or disable the marker table. When enabled, the marker table is shown in the following figure. The marker table lists the marker events of the displayed waveforms in the current waveform view.

When you zoom or adjust the waveforms, the events in the marker table will change. You can perform the following operations on the marker table.

- When the instrument is in STOP status, click or tap any row in the marker table to select the specified event. The upside-down triangle that marks the selected event turns red (▲).
- Click or tap the icon  at the upper-right corner of the marker table to open the Search menu.
- Long clicking or tapping the marker table header in gray can move the position of the table on the screen.
- Click or tap the icon  at the upper-right corner of the table to close the marker table.

| Index | Time     | EventCount | Info        |
|-------|----------|------------|-------------|
| 1     | -50us    | 1          | Rising edge |
| 2     | -49.59us | 1          | Rising edge |
| 3     | -48.79us | 1          | Rising edge |
| 4     | -47.99us | 1          | Rising edge |
| 5     | -47.19us | 1          | Rising edge |
| 6     | -46.39us | 1          | Rising edge |
| 7     | -45.59us | 1          | Rising edge |
| 8     | -44.79us | 1          | Rising edge |
| 9     | -43.99us | 1          | Rising edge |
| 10    | -43.19us | 1          | Rising edge |

Figure 22.2 Marker Table

## 5. Navigation

Click or tap **Navigation** to go to the navigation interface. You can also refer to *Navigation Function* to learn more about the navigation operation.

## 6. Save events

You can save the event marker data to the internal memory or external USB storage device in "\*.csv" format.

Click or tap **Save events** to enter the event saving interface. Please refer to descriptions in *To Save a File* to save the event marker data to the internal or external memory.



### NOTE

This series oscilloscope only supports the flash memory USB storage device of FAT32 format.

## 22.2 Navigation Function

The navigation function includes the time navigation and search event navigation. To enter the **Navigation** interface, perform any of the following operations:

- Press  on the front panel to enter the "Navigation" menu.
- Click or tap the **Navigate** icon on the toolbar at the upper-right part of the screen to enter the Navigation menu.
- In the Search interface, click or tap the **Navigation** button to enter the Navigation setting menu.

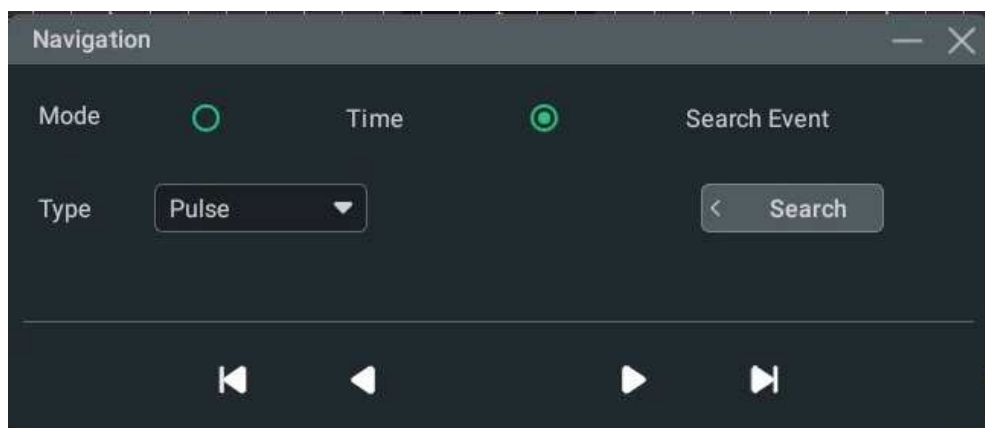



Figure 22.3 Navigation Menu

Clicking or tapping the icon  can minimize the Navigation window, making the interface simple and clear, as shown in the figure below.

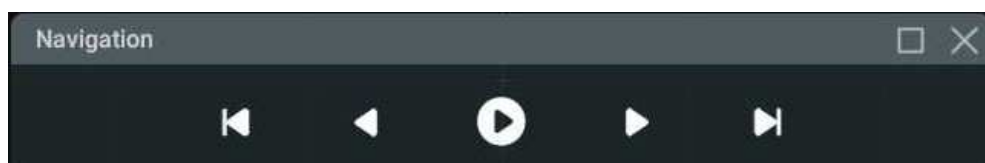

Figure 22.4 Navigation Menu-Simple Mode







### Notice

The navigation function is only available when the operating status is STOP.

### Time Navigation

After stopping data acquisition, use the navigation control buttons in the Navigation interface to play forward and backward the captured waveforms. You can also use the

navigation combination keys    on the horizontal control area on the front panel to control the waveforms.

- After selecting time navigation, click or tap  to start to play and pause the waveforms.
- During the play, click or tap  to play backward, then stops automatically until it reaches the end; click or tap  to play forward, then stops automatically until it reaches the end.
- When it stopped playing, click/tap  or  to move backward or forward the waveforms.
- Click or tap  to go to the start segment of the waveforms to be played. Click or tap  to go to the last segment of the waveforms to be played.

Click or tap the drop-down button of **Speed** to select the play speed of the waveforms.

### Search Event Navigation



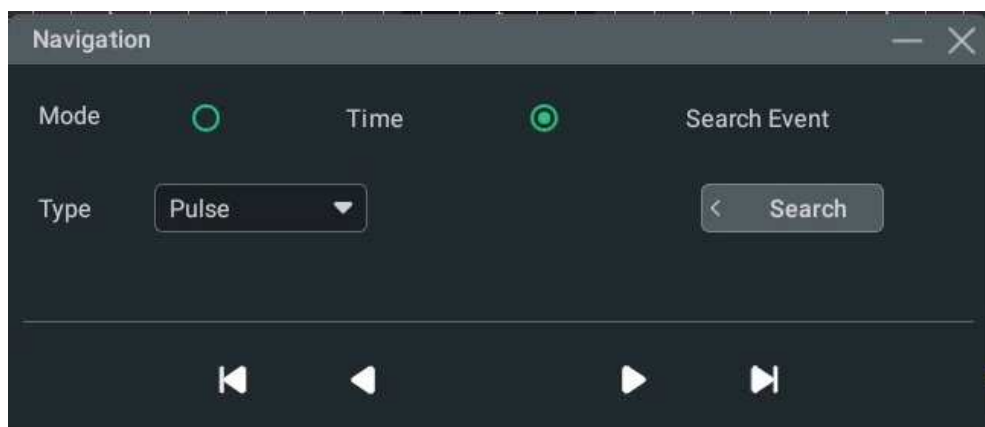

When you enable the navigation function and complete the event search, you can use the navigation combination keys to quickly navigate the specific event in the event mark table.



**Figure 22.5 Search Event Navigation Interface**

After selecting the "Search Event" navigation, click or tap **Search** to set the search conditions.

The search event type can be set to "Edge" or "Pulse", which shall be consistent with the search type specified in **Search** menu.

Click or tap  to navigate to the previous event (the serial number in the mark table decreases); click or tap  to navigate to the next event (the serial number in the mark table increases); click or tap  to go to the first event; click or tap  to go to the last event.

## 23 Display Control

In the **Display** setting menu, you can set the type, persistence time, waveform intensity, grid type, grid brightness, and etc. Click or tap the function navigation icon



at the lower-left corner of the screen, and then select **Display** to enter the

"Display" menu. You can also click or tap the icon at the upper-right of the Waveform View to enter the "Display" menu.

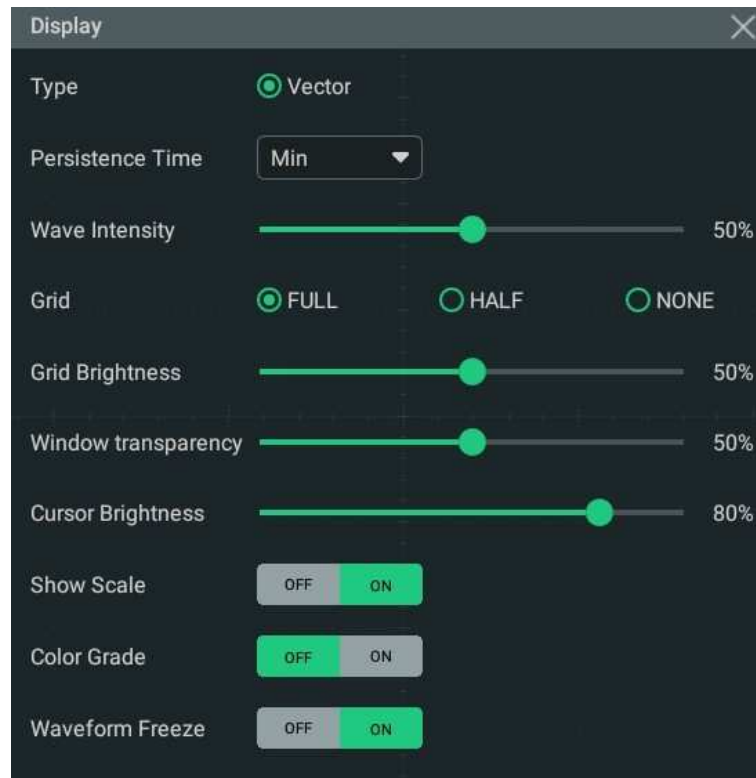

Figure 23.1 Display Setting Menu

### 23.1 Display Type

This series oscilloscope provides the "Vector" display mode in which the sample points are connected by lines and displayed. In most cases, this mode can provide the most vivid waveform for you to view the steep edge of the waveform (such as square waveform).

### 23.2 Persistence Time

In the **Display** setting menu, click or tap the drop-down button of **Persistence Time** to select the persistence time. The available values are Min, specific values (100 ms, 200 ms, 500 ms, 1 s, 2 s, 5 s, 10 s), and Infinite.

In the following part, a frequency sweep signal of the sine waveform is used to show the waveform effects in different persistence times.

- **Min**

Enables you to view waveform changing in high refresh rate.

- **Specific Values**

Enables you to view glitches that change relatively slowly or glitches with lower occurrence probability. The persistence time can be set to 100 ms, 200 ms, 500 ms, 1 s, 2 s, 5 s, or 10 s.

- **Infinite**

In this mode, the oscilloscope displays the waveform newly acquired without clearing the waveforms acquired formerly. The waveforms acquired formerly will be displayed in relatively low-brightness color and the newly acquired waveforms will be displayed in normal brightness and color. Infinite persistence can be used to measure noise and jitter and to capture incidental events.

## 23.3 Waveform Intensity

In **Display** menu, drag the slide bar of **Wave Intensity** to set the brightness of waveforms. The default is 50%, and the range available is from 1% to 100%.

## 23.4 To Set the Screen Grid

In the **Display** menu, select "FULL", "HALF", or "NONE" in **Grid**.



- **FULL:** turns the background grid on.
- **HALF:** turns part of the grid off, leaving only the main grid.
- **NONE:** turns the background grid off.

## 23.5 Display Settings

### Grid Brightness

In the **Display** setting menu, drag the slider of **Grid Brightness** to set the grid brightness. The default is 50%, and the range available is from 0% to 100%.

### Window Transparency

In the **Display** setting menu, drag the slider of **Window Transparency** to set the window transparency. The default is 50%, and the range available is from 0% to 100%.

### Cursor Brightness

In the **Display** setting menu, drag the slider of **Cursor Brightness** to set the cursor brightness. The default is 80%, and the range available is from 0% to 100%.

## 23.6 Show Scale

In the **Display** setting menu, click or tap the **Show Scale** on/off switch to enable or disable scale display on the screen. By default, it is ON.

## 23.7 Color Grade

In the "Display" setting menu, click or tap the ON/OFF tab for **Color Grade** to enable or disable the color grade. By default, it is OFF.

When enabled, different colors are displayed on the screen to indicate the times of data acquisition or acquisition probability.

## 23.8 Waveform Freeze

In the "Display" setting menu, click or tap the ON/OFF tab for **Waveform Freeze** to enable or disable the waveform freeze function. By default, it is ON.

When enabled, the oscilloscope displays the waveform that has undergone multiple samplings and superpositions after sampling is stopped when you click or tap the

**STOP/RUN** icon on the quick operation toolbar or press  on the front panel. If disabled, the last triggered waveform is displayed.

## 24 To Store and Load

---

You can save the current setups, waveforms, screen image, and parameters of the oscilloscope to the internal memory or external USB storage device (such as USB storage device) in various formats and recall the stored setups or waveforms when necessary. You can also load the upgrade software to the system and perform the upgrade operation for the instrument.

You can also copy, delete, or rename the specified type of file from the internal memory or external USB storage device via the disk management menu.

This oscilloscope provides two USB HOST interfaces on the front panel, which can all be connected to the USB storage device for external storage. The USB storage devices connected are marked as "Removable USB Disk (D)" and "Removable USB Disk (E)".

### TIP

This oscilloscope only supports the flash memory USB storage device of FAT32 format.



### 24.1 To Enter the Storage Menu

---

You can enter the storage setting menu in the following ways.

- Click or tap the function navigation icon  at the lower-left corner of the screen, and then select **Storage** to enter the storage setting menu.
- Click or tap the **Storage** button on the toolbar to enter the storage setting menu.

In the **Storage** setting menu, there are three sub-menus (Save, Load, and Upgrade) for you to choose. Select the specified sub-menu and configure the corresponding parameters.

### 24.2 To Save a File

---

In the **Storage** menu, click or tap the **Save** tab to enter the save setting menu. In this menu, you can save the image, waveform, or setup files.

#### 24.2.1 To Save Image

---

In the Storage interface, click or tap the **Save** tab to enter the Save interface. Click or tap the drop-down button of **Choose** to select **Save Image**. The screen image will be saved to the internal or external memory based on the settings.

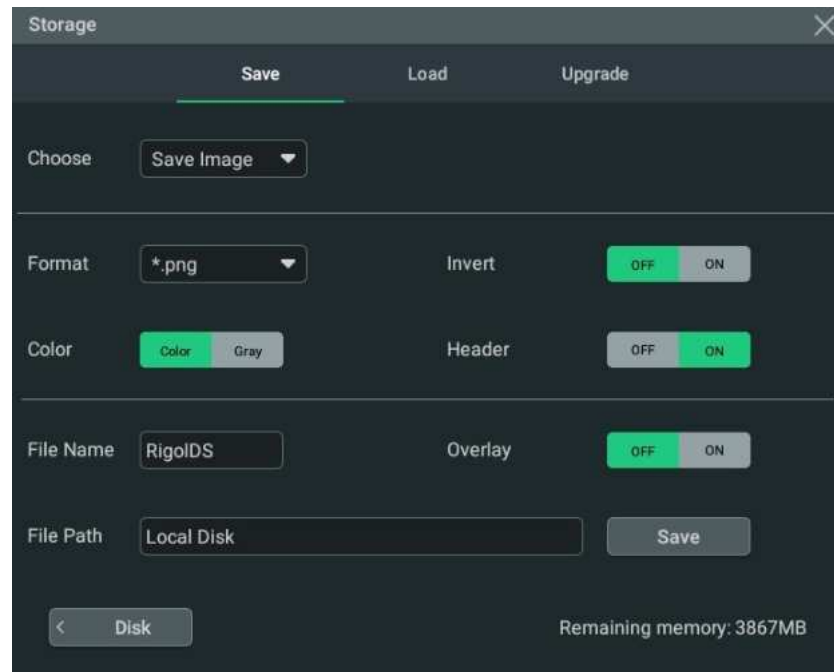

Figure 24.1 Image Saving Setting Menu

### Set the Image Format

- **Format:**

Click or tap the drop-down button of **Format** to select "\*.png", "\*.bmp", or "\*.jpg" from the drop-down list. Then the screen image will be saved to the internal or external memory in ".png", ".bmp", or ".jpg" format.

- **Invert:**

Click or tap the ON/OFF button for the **Invert** menu to enable or disable the waveform invert function.

- **Color:**

Click or tap "Color" or "Gray" for **Color** to select the desired storage color.

- **Header:**

Click or tap the ON/OFF tab for the **Header** menu to enable or disable the display of the header. If you select "ON", the instrument model and the image creation date will be displayed in the header of the image when you save the image file.

### Set the File Saving Parameters

- **Set the filename**

Click or tap the input field of **File Name** to input the file name to be saved with the pop-up virtual keypad.

- **Set the file path**

Click or tap the input field of **File Path**, then the disk management interface is displayed. In the disk management interface, select the destination storage path, then click or tap **OK** to set the storage path for the saved file. For the disk management operation, refer to descriptions in *Disk Management*.

When no USB storage device is inserted, by default, the storage path is "Local Disk". When a USB storage device is detected, "D:" is automatically showed in the file path.

- **Overlay**

Click or tap the ON/OFF button for the **Overlay** menu to enable or disable the overwriting function. When enabled, the existing file in the specified file path will be overwritten by the newly saved file that has the same filename as the existing one.

Click or tap **Save**, the screen image is saved based on the current settings and the storage menu is closed.

**TIP**

When the quick operation type is set to "Save Image", or set to "Save Group" with "Save

Image" being selected, pressing the front-panel quick operation key  can quickly save the image.



## 24.2.2 To Save Wave

In the **Storage** menu, click or tap the **Save** tab to enter the save operation menu. In this menu, click or tap the drop-down button of **Choose** to select "**Save Wave**" to enter the "Save Wave" setting menu. The main setting information (e.g. "On/Off" state of the channel, vertical scale, and horizontal time base) and waveform data of all enabled channel will be save to the internal or external memory.

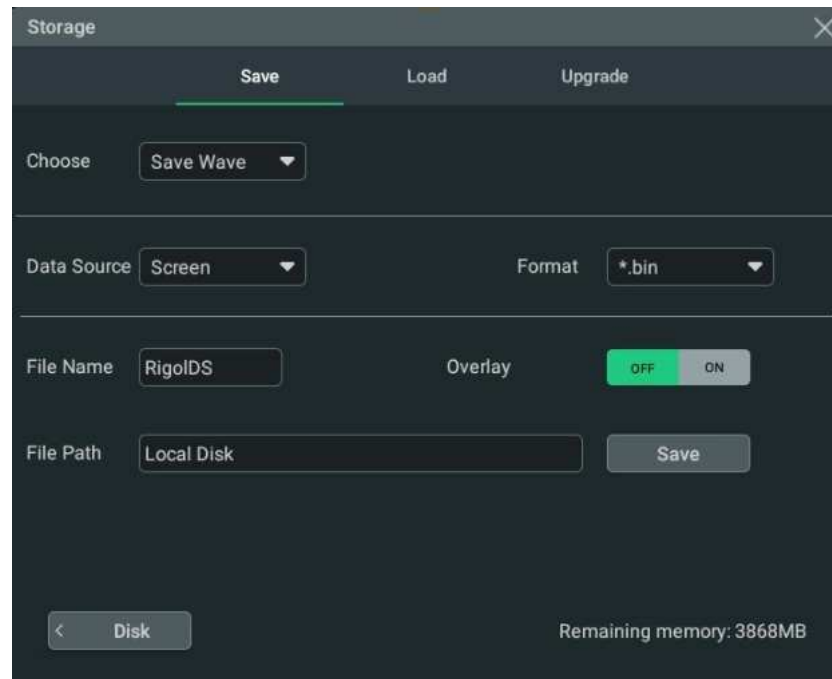

Figure 24.2 Waveform Saving Setting Menu

### Set the Source of the Waveform Data and the Format of the Saved Waveform

- **Data Source**

The waveforms on the screen, from the internal memory, or recorded waveforms in *Waveform Recording and Playing* can all be considered as the source of the waveform data. Click or tap the drop-down button of **Data Source** to select "Screen", "Memory", or "Record".

- **Set the Waveform Format**

Click or tap the drop-down button of **Format** to select the desired format of the saved waveform. When "Screen" is selected, the available formats include "\*.bin" and "\*.csv". When "Memory" is selected, the available formats include "\*.bin", "\*.csv", and "\*.wfm". When "Record" is selected, the available format includes "\*.csv".

### Set the File Saving Parameters

- **Set the filename**

Click or tap the input field of **File Name** to input the file name to be saved with the pop-up virtual keypad.

- **Set the file path**

Click or tap the input field of **File Path**, then the disk management interface is displayed. In the disk management interface, select the destination storage path,

then click or tap **OK** to set the storage path for the saved file. For the disk management operation, refer to descriptions in *Disk Management*.

When no USB storage device is inserted, by default, the storage path is "Local Disk". When a USB storage device is detected, "D:" is automatically showed in the file path.

- **Overlay**

Click or tap the ON/OFF button for the **Overlay** menu to enable or disable the overwriting function. When enabled, the existing file in the specified file path will be overwritten by the newly saved file that has the same filename as the existing one.

Click or tap **Save** to save the waveform file based on the current settings and the storage menu is closed.

**TIP**

When the quick operation type is set to "Save Wave", or set to "Save Group" with "Save Wave" being selected, pressing the front-panel quick operation key  can quickly save the waveform file.

### 24.2.3 Save Setup

In the **Storage** menu, click or tap the **Save** tab to enter the save operation menu. In this menu, click or tap the drop-down button of **Choose** to select "**Save Setup**" to enter the "Save Setup" setting menu. Save the settings of the oscilloscope to the internal or external memory in "\*.stp" format. When loading, the stored settings can be recalled.

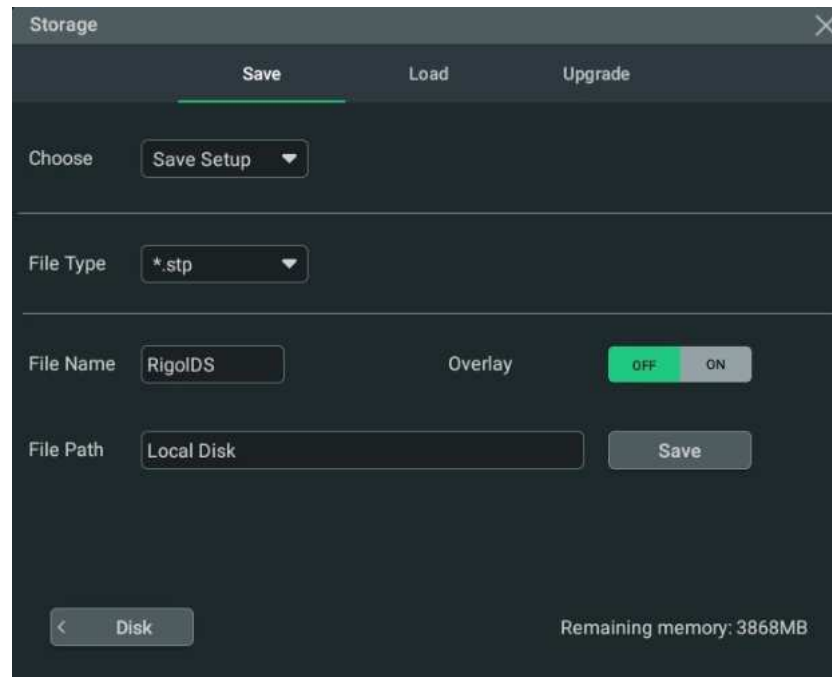

**Figure 24.3 Setup Saving Setting Menu**

### Set the File Saving Parameters

- **Set the filename**

Click or tap the input field of **File Name** to input the file name to be saved with the pop-up virtual keypad.

- **Set the file path**

Click or tap the input field of **File Path**, then the disk management interface is displayed. In the disk management interface, select the destination storage path, then click or tap **OK** to set the storage path for the saved file. For the disk management operation, refer to descriptions in *Disk Management*.

When no USB storage device is inserted, by default, the storage path is "Local Disk". When a USB storage device is detected, "D:" is automatically showed in the file path.

- **Overlay**

Click or tap the ON/OFF button for the **Overlay** menu to enable or disable the overwriting function. When enabled, the existing file in the specified file path will be overwritten by the newly saved file that has the same filename as the existing one.

Click or tap **Save** to save the setup file based on the current settings and the storage menu is closed.

**TIP**

When the quick operation type is set to "Save Setup", or set to "Save Group" with "Save Setup" being selected, pressing the front-panel quick operation key  can quickly save the setup file.

## 24.2.4 Binary Data Format (.bin)

Binary data format stores waveform data in binary format and provides data headers that describe these data. As data are displayed in binary format, its file size is much more smaller than that in ASCII format. If several channels are enabled, then all the displayed channels will be saved (save the first channel then save the second, and then it goes on like this until all the displayed channels are saved).

**Table 24.1 BIN File Format**

| File Header | Waveform Header | Waveform Data Header | Channel Data | Waveform Header | Waveform Data Header | Channel Data |
|-------------|-----------------|----------------------|--------------|-----------------|----------------------|--------------|
| 16 Bytes    | 140 Bytes       | 16 Bytes             | n Bytes      | 140 Bytes       | 16 Bytes             | n Bytes      |

In BIN file format, it contains the following channel data:

- CH1 Data
- CH2 Data
- CH3 Data
- CH4 Data
- Math Waveform Data

### Binary Header Format

#### 1. File Header

There is only one file header in a binary file. The file header contains the following information.

**Table 24.2 File Header**

|         |   |
|---------|---|
| Cookie  | Two-byte characters, RG, indicating that the file is the RIGOL binary data file format. |
| Version | Two-byte, indicating the file version.  |

|                     |   |
|---------------------|---|
| File Size           | An 8-byte long integer, indicating the number of bytes in the file. It includes the header. |
| Number of Waveforms | A 4-byte integer, indicating the number of waveforms that are stored in the file.           |

## 2. Waveform Header

It is possible to store several waveforms in the file. Each stored waveform has a waveform header. When several channels are stored, each channel can be considered as a separate waveform. The waveform header contains the information about the type of waveform data that are stored following the waveform data header.

**Table 24.3 Waveform Header**

|                            |  |
|----------------------------|--|
| Header Size                | A 4-byte integer, indicating the number of bytes in the header.  |
| Waveform Type              | A 4-byte integer, indicating the type of the waveform stored in the file. It is fixed to 1.<br><ul style="list-style-type: none"> <li>- 0 = Unknown</li> <li>- 1 = Normal</li> <li>- 2 = Peak Detection</li> <li>- 3 = Average</li> <li>- 4 = Not Used</li> <li>- 5 = Not Used</li> <li>- 6 = Logic</li> </ul>   |
| Number of Waveform Buffers | A 4-byte integer, indicating the number of waveform buffers required to read the data. It is fixed to 1.   |
| Number of Points           | A 4-byte integer, indicating the number of waveform points in the data.  |
| Count                      | A 4-byte integer. It is fixed to 0.  |
| X Display Range            | A 4-byte float, indicating the X-axis duration of the waveform that is displayed. For time-domain waveforms, it indicates the duration of the display. If the value is zero, then no data has been acquired.   |
| X Display Origin           | An 8-byte double-precision floating-point, indicating the X-axis value at the left edge of the screen. For time-domain waveforms, it indicates the time at the start of the display. The value is treated as a double precision 64-bit float point number. If the value is zero, then no data has been acquired. |

|              |   |
|--------------|---|
| X Increment  | An 8-byte double-precision floating-point, indicating the duration between data points on the X-axis. For time-domain waveforms, it indicates the time between points. If the value is zero, then no data has been acquired.  |
| X Origin     | An 8-byte double-precision floating-point, indicating the X-axis value of the first data point in the data recording. For time-domain waveforms, it indicates the time of the first point. The value is treated as a double precision 64-bit float point number. If the value is zero, then no data has been acquired.              |
| X Units      | A 4-byte integer, indicating the unit of measurement for X values in the acquired data. It is fixed to 2. <ul style="list-style-type: none"> <li>- 0 = Unknown</li> <li>- 1 = Volts (V)</li> <li>- 2 = Seconds (s)</li> <li>- 3 = Constant</li> <li>- 4 = Amps (A)</li> <li>- 5 = Decibel (dB)</li> <li>- 6 = Hertz (Hz)</li> </ul> |
| Y Units      | A 4-byte integer, indicating the unit of measurement for Y values in the acquired data. The possible values are listed above under X Units.   |
| Date         | A 16-byte character array, indicating the date when the file is saved.  |
| Time         | A 16-byte character array, indicating the time when the file is saved.  |
| Model        | A 24-byte character array in the format of MODEL#:SERIAL#, indicating the oscilloscope's model and serial number.   |
| Channel Name | A 16-byte character array that contains the label assigned to the waveform.   |

### 3. Waveform Data Header

A waveform may have multiple data sets. Each waveform data set has a waveform data header. The waveform data header consists of information about the waveform data set. The header is stored before the data set.

**Table 24.4 Waveform Data Header**

|             |   |
|-------------|---|
| Header Size | A 4-byte integer, indicating the number of bytes in the waveform data header. |
|-------------|---|

|                 |   |
|-----------------|---|
| Buffer Type     | <p>A 2-byte integer, indicating the type of the waveform data stored in the file.</p> <ul style="list-style-type: none"> <li>- 0 = Unknown</li> <li>- 1 = Normal 32-bit float data</li> <li>- 2 = Maximum float data</li> <li>- 3 = Minimum float data</li> <li>- 4 = Not Used</li> <li>- 5 = Digital unsigned 8-bit character data (for digital channels)</li> </ul> |
| Bytes Per Point | A 2-byte short integer, indicating the number of bytes per data point.  |
| Buffer Size     | An 8-byte long integer, indicating the number of bytes of the current channel waveform data.  |

## 24.3 To Load a File

In the storage setting menu, click or tap the **Load** tab to switch to the load menu. In this menu, you can load the local file to the instrument.

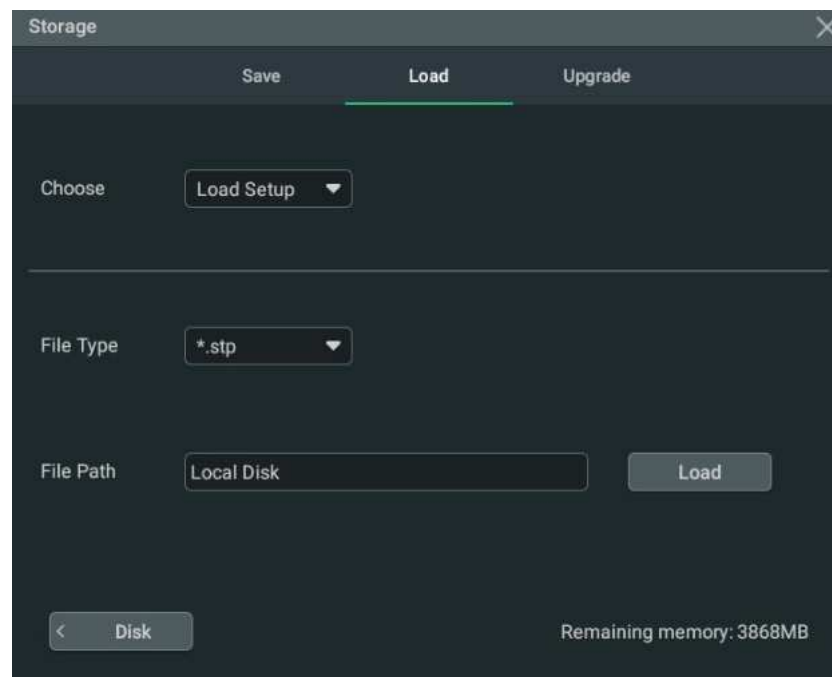

Figure 24.4 Load Setting Menu

### Load Setup

Click or tap the drop-down button of **Choose** to select "Load Setup". Then, click or tap **File Path** to load the setups from the internal memory or the external USB disk.

The default file type is "\*.stp", and no other options are available. Select the file to be loaded from the memory. Click or tap **Load** to load the selected file.

## 24.4 Firmware Upgrade

This instrument supports local upgrade and online upgrade.

### Local upgrade

1. In the storage setting menu, click or tap **Upgrade** to enter the local upgrade setting menu.

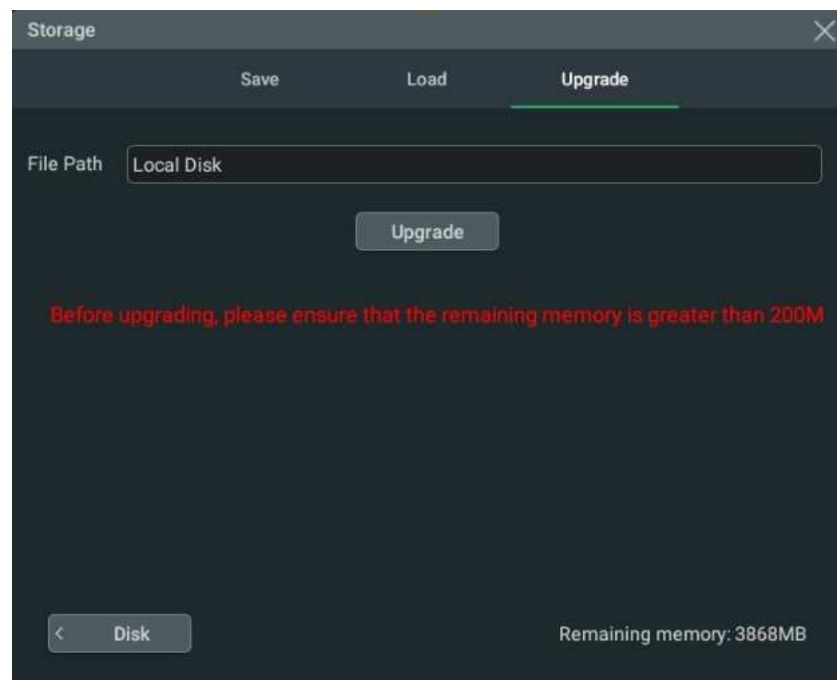



Figure 24.5 Upgrade Menu

2. Click or tap the input field of **File Path**, then the disk management interface is displayed. Select the upgrade file. For detailed operations, refer to *Disk Management*.
3. Click or tap **Upgrade** to complete the local upgrade.

### Online upgrade

1. First ensure that the rear-panel LAN interface is connected to the network (if you have limited access to the Internet, please ask the administrator for permission).
2. Click or tap the function navigation icon  at the lower-left corner of the screen to enter the function navigation.
3. Then click or tap the **Upgrade** icon to perform the upgrade operation.

## 24.5 Disk Management

To enter the storage setting interface, perform any of the following operations:

- Click or tap the function navigation icon  at the lower-left corner corner of the screen, and then select **Storage** to enter the storage setting interface.
- Click or tap the **Storage** icon on the quick operation toolbar to enter the storage setting interface.

In the storage setting interface, click or tap **Disk** to enter the disk management interface.

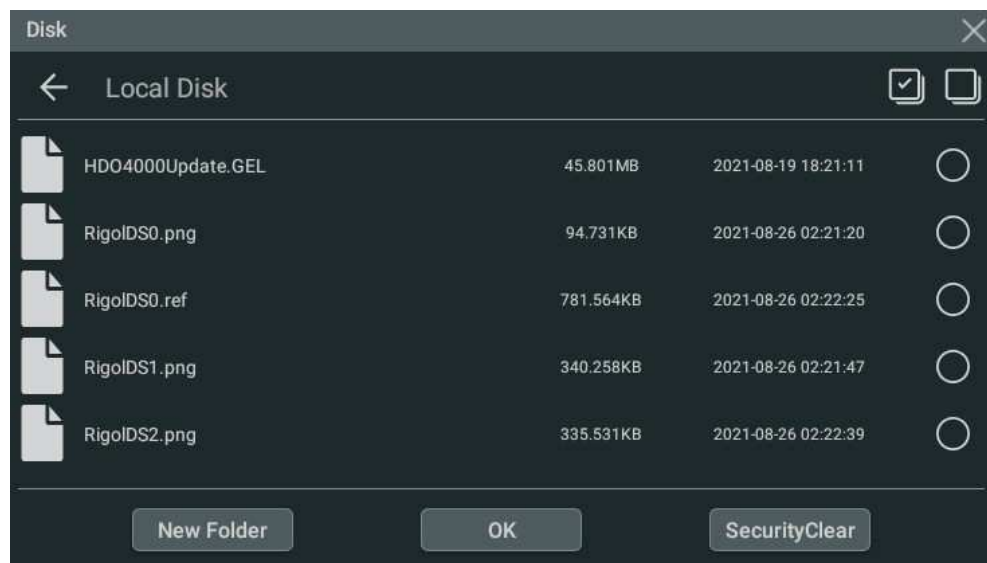

**Figure 24.6 Disk Management Interface**

In the disk management menu, you can perform the following operations:

### Select a Disk

Before using the external storage device, make sure that a USB storage device (FAT32 format, flash memory) is connected properly.

By default, Local Disk (Disk C) is displayed. If an external storage device is inserted, the available disks include "Local Disk (C)", "Removable USB Disk (D/E...)". If you select an external storage device, for example, Removable USB Disk (D), you can view the storage contents in it.

### Create a Folder

Click or tap **New Folder**, then a folder name input keyboard is displayed.



For the name input method, refer to descriptions in *Parameter Setting Method*. Click or tap any place on the Storage interface to exit the keyboard interface.



### Clear the Internal Memory Safely

Click or tap **SecurityClear**, then a prompt message "Execute secure memory wipe?" is displayed. Click or tap **OK** to clear all the files stored in the internal disk. Otherwise, click or tap **Cancel** to cancel security clear operation.

### Select a File

Before operating on the file or folder, first select the desired file or folder.

Click or tap the check box at the right side of the folder, if checked, it is selected, with an icon  being displayed. Click or tap the check box again or  to deselect it. The check box restores its original state.

This series supports selecting multiple files or folders to operate on. You can also click or tap the icon  at the upper-right corner of the interface to select all the files and folders under the current disk. Click or tap  to cancel the select-all operation.

### Cut, Copy, or Paste a File or a Folder

- **Cut a File to a Specified Folder**

Select a specified file or folder. Click or tap **Cut** to cut the specified file or folder. Then select the destination folder. Then click or tap **Paste** to paste the specified file or folder to the destination folder.

- **Copy a File to a Specified Folder**

Select a specified file or folder. Click or tap **Copy** to copy the specified file or folder. Then select the destination folder. Then click or tap **Paste** to paste the specified file or folder to the destination folder.

### Delete a File or Folder

In the current folder, select the file or folder to be deleted. Click or tap **Delete**, then a prompt message "Are you sure to delete the file?" is displayed. Click or tap **OK** to delete the file. Otherwise, click or tap **Cancel** to cancel the deletion operation.

### Rename a File or Folder

Select a specified file or folder, then click or tap **Rename** to input a new filename or folder name with the pop-up virtual keypad. Then, the rename operation is completed.

## 25 System Utility Function Setting

---

In the **Utility** menu, you can set the I/O parameters and the system-related function parameters. You can enter the "Utility" menu in the following ways.

- Click or tap the Notification Area at the lower-right corner of the screen. Then the **Utility** menu is displayed.
- Click or tap the function navigation icon  at the lower-left corner of the screen, and then select **Utility** to enter the **Utility** menu.

### 25.1 I/O Setting

---

In the **Utility** menu, click or tap **I/O** to enter the I/O setting menu to configure the following parameters.

#### Network Status

Different prompts will be displayed according to the current network connection status.

- Network Config Succeeded!
- Acquiring IP...
- IP Conflict!
- DISCONNECTED!
- DHCP Config Failed
- Read Status Fail!
- CONNECTED
- Invalid IP
- IP lost
- Please wait...

#### MAC Address

The MAC address of each oscilloscope is unique. When assigning the IP address for the oscilloscope, the system uses the MAC address to identify the instrument.

#### VISA Address

Displays the VISA address currently used by the the instrument.

## IP Configuration Type

The configuration type of the IP address can be DHCP, Auto IP, or Static IP. In different IP configuration types, the configurations for IP address and other network parameters are different.

- **DHCP**

If "DHCP" is selected, the DHCP server in the current network will assign the network parameters (e.g. IP address, Subnet, Gateway, and DNS) for the instrument.

- **Auto IP**

When "Auto IP" is selected, the instrument will acquire the IP address ranging from "169.254.0.1" to "169.254.255.254" and the subnet mask (255.255.0.0) automatically based on the current network configuration. The "Auto IP" works only when "DHCP" is not selected or connection is failed.

- **Static IP**

If "Static IP" is selected, the instrument is configured with static IP. In this case, you need to disable DHCP and Auto IP manually. At this time, you need to set the IP address, Subnet, Gateway, and DNS manually. At this time, you can self-define the network parameters (e.g. IP address) of the instrument.

- **Set the IP address**

The format of the IP address is nnn.nnn.nnn.nnn. The range of the first segment (nnn) of the address is from 0 to 255 (except 127); wherein, the valid range is from 0 to 223. The range for the other three segments is from 0 to 255. You are recommended to ask your network administrator for an IP address available.

This setting will be saved to the non-volatile memory; if "Load last" is set to "Last", then DHCP and Auto IP are disabled at the next power-on. The instrument will load the preset IP address automatically.

- **Set the subnet mask**

The format of the subnet mask is nnn.nnn.nnn.nnn. Wherein, the range of "nnn" is from 0 to 255. You are recommended to ask your network administrator for a subnet mask available.

This setting will be saved in the non-volatile memory; if "Load last" is set to "Last", then DHCP and Auto IP are disabled at the next power-on. The instrument will load the preset subnet mask automatically.

- **Set the default gateway**

You can set this parameter in Static IP mode. The format of the gateway is nnn.nnn.nnn.nnn. The range of the first segment (nnn) is from 0 to 223 (except 127), and the range for the other three segments is from 0 to 255.

You are recommended to ask your network administrator for a gate address available.

This setting will be saved in the non-volatile memory; if "Load last" is set to "Last", then DHCP and Auto IP are disabled at the next power-on. The instrument will load the preset gateway automatically.

- **Set the DNS address**

You can set this parameter in Static IP mode. The format of the DNS address is "nnn.nnn.nnn.nnn". The range for the first segment (nnn) of the address is from 0 to 223 (except 127); and the range for the other three segments is from 0 to 255. You are recommended to ask your network administrator for an address available.

Generally, you do not need to set the DNS, therefore this parameter setting can be ignored.



**TIP**

- When the three IP configuration types are all turned on, the priority of the parameter configuration from high to low is "DHCP", "Auto IP", and "Static IP".
- The three IP configuration types cannot be all turned off at the same time.

**mDNS**

Click or tap the ON/OFF tab for mDNS to enable or disable the multicast Domain Name System (mDNS). This system is used to provide the function of DNS server for service discovery in a small network without a DNS server.

**Host Name**

The length of the host name is a string of 26 characters at most.

**GPIB**

When controlling the instrument via the GPIB, first use the USB-GPIB module to extend a GPIB interface, then use the GPIB cable to connect it to the PC. Configure the GPIB address. Its settable range is from 1 to 30. By default, it is 1.

**Apply the Network Parameter Setting**

Click or tap **Apply** to validate the current network parameter setting.

## 25.2 Basic Settings

In the **Utility** menu, click or tap **Setup** to enter the basic setting menu.

**Language**

This product supports menus in multiple languages. The help information, prompt messages, and interface can be displayed in multiple languages. Click or tap the

drop-down button of **Language** to select the specified system language from the drop-down list.

### Screen Brightness

Drag the slide to set the screen brightness. Its range is from 1% to 100%.

### Load Last

You can set the system configuration to be recalled when the oscilloscope is powered on again after power-off. Click or tap "Default" or "Last" for **Load Last**.

- Last: restores the system to its last setting at last power-off.
- Default: restores the system to its factory setting.

### Power Status

- Switch Off: After the oscilloscope is connected to power, you need to press the Power key on the front panel to power on the instrument.
- Switch On: After the the oscilloscope is connected to power, it will be powered on automatically.

### Beeper

Click or tap the ON/OFF tab for the **Beeper** menu to enable/disable the beeper. When the beeper is enabled, you can hear the sound of the beeper when you perform the following operations:

- Press a key or a menu key on the front panel
- Operate on the touch screen
- When a prompt message is displayed

### AUX Out

Click or tap to select the desired signal type output from the rear-panel **[AUX OUT]** connector. The available signal types are "TrigOut" and "PassFail".

- **TrigOut:** After this type is selected, at each trigger (hardware trigger), the oscilloscope outputs a signal from the **[AUX OUT]** connector on the rear panel that can reflect the current capture rate of the oscilloscope. If this signal is connected to a waveform display device to measure the frequency, it can be found that the measurement result is the same as the current capture rate.

When the AUX Out menu is set to "TrigOut", then in the pass/fail test menu (click or tap  > **Pass/Fail** to enter the pass/fail test menu), the **Aux Output** menu item is automatically disabled.





- **PassFail:** After this type is selected, the instrument can output a positive or negative pulse via the **[AUX OUT]** connector when a successful or failed event is detected.

When the AUX Out menu is set to "PassFail", then in the pass/fail test menu

(click or tap  > **Pass/Fail** to enter the pass/fail test menu), the **Aux Output** menu item is automatically enabled. For the parameter settings such as pulse width, polarity, and output event of the pulse signal output from the connector, you can set it in the "Option" menu of the "PassFail" interface. For details, refer to *To Set the Output Form of the Test Results*.

### Input Lock

When enabled, the input operation is disabled. Both the touch screen operation and the front-panel keys except the Power key are disabled. You cannot operate with the touch screen and front-panel keys and knobs.

To unlock the keys, press the front-panel channel keys CH1 ()<sub>1</sub>, CH1 ()<sub>1</sub>, CH2 ()<sub>2</sub>, and CH2 ()<sub>2</sub> in sequence to unlock the keys.

### Vertical Expansion

Click or tap to select the way to expand or compress the waveform. It can be set to "Center" or "GND".

- Center: when the vertical scale is changed, the waveform will be expanded or compressed around the screen center.
- GND: when the vertical scale is changed, the waveform will be expanded or compressed around the signal ground level position.

### Display Time

Click or tap the ON/OFF tab for the **Display Time** menu to enable or disable the display of the system time. When enabled, the system time (date and time) is displayed in the Notification Area at the lower-right corner of the screen. The date is displayed in "yyyy/mm/dd" format, and the time is displayed in "hh:mm:ss" format. You can enable or disable the display of system time when saving the waveform. When enabled, the saved file will contain the system time information.

- **Date:** Click or tap the "Date" area, then the date setting interface is displayed. Drag the year, month, and day section up and down respectively to set the date. Click or tap **OK** to confirm the date modification. Click or tap the close window icon  to cancel the date modification and exit the menu. You can also click or tap any place other than the date setting interface to exit the date modification menu.

- **Time:** Click or tap the "Time" area, then the time setting interface is displayed. Drag the hour and minute section up and down respectively to set the time. Click or tap **OK** to confirm the time modification. Click or tap the close window icon  to cancel the time modification and exit the menu. You can also click or tap any place other than the time setting interface to exit the time modification.

## 25.3 About this Oscilloscope

In **Utility** menu, click or tap **About**, and then you can view the model, version, and other information about this instrument in **About** menu.

- **Model**  
Indicates the product model.
- **Serial Number**  
Indicates the serial number, the unique identification for the product.
- **Firmware**  
Indicates the firmware version number of the product.
- **Hardware**  
Indicates the hardware version number of the product.
- **Build**  
Indicates the creation time of the software version.
- **Android.Build**  
Indicates the creation time of the Android operating system.
- **Android.Version**  
Indicates the version number of the Android operating system. For example, 7.1.0.
- **Launcher**  
Indicates the desktop UI version number of the Android operating system.
- **WebControl**  
Indicates the version number of browser remote control module.

## 25.4 Other Settings

### EXT 10M IN

Indicates the rear-panel **[10MHz REF IN]** reference clock input interface. When ON, the interface is enabled; when OFF, the interface is disabled.

## Open Source Acknowledgment

Click or tap **Open Source Acknowledgment** to open the Open Source Acknowledgment of this series oscilloscope.

## 25.5 Auto Config

In the "Utility" menu, click or tap **Auto Config** to enter the Auto Config menu. You can configure the **Auto** function.

- Click or tap the ON/OFF tab for **Peak** to Peak to enable or disable the peak-peak priority setting. This function is intended for the shifted signal. If there is a large deviation, you can view the signal waveform in priority when you enable the function.
- Click or tap the ON/OFF tab for **Live CH** to enable or disable test the enabled channel.

If you select "OFF", the system will test all analog channels in sequence when performing AUTO operation. If no signal is found on the channel, then the channel is disabled. If a signal is found on the channel, the channel will be adjusted to an optimal scale to show the signal. If you select "ON", the system will only test the enabled channels when performing AUTO operation.

- Click or tap the ON/OFF tab for **Overlay** to enable or disable the waveform overlay display function. If enabled, waveforms of the different channels will be displayed in the same position of the screen when you perform auto setting. If disabled, waveforms of different channels will be displayed on the screen from top to bottom in sequence.
- Click or tap the ON/OFF tab for **Keep Coupling** to enable or disable the channel coupling keeping. If enabled, the settings for the channel coupling remain unchanged when you perform the auto setting operation. If disabled, the channel is DC-coupled by default.

## 25.6 SelfCal

The self-calibration program can quickly make the oscilloscope to work in an optimal state to get the precise measurement results. You can perform self-calibration at any time, especially when the changes of the ambient temperature reach or exceed 5°C. Make sure that the oscilloscope has been warmed up or operating for more than 30 minutes before the self-calibration.

In "Utility" menu, click or tap **SelfCal**, the self-calibration menu is as shown below.

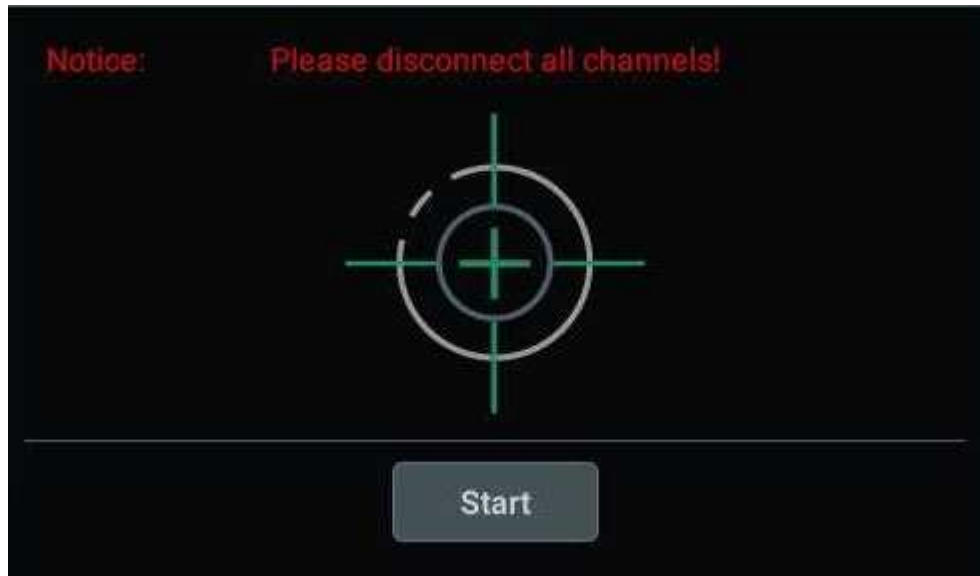

Figure 25.1 Self-calibration Menu

- Click or tap **Start**, and then the oscilloscope will start to execute the self-calibration program.
- After starting the self-calibration program, click or tap **Exit** to cancel self-calibration operation at any time.
- Click or tap **Close** to close the self-calibration information window.

## 25.7 Option List

In the **Utility** menu, click or tap **Options** to view all the options. For the procedures of installing the option, refer to descriptions in *To View the Option Information and the Option Installation*.

## 25.8 Quick Operation

In the **Utility** menu, click or tap **Quick** to enter the quick setting operation menu.

### To Save Image

- Click or tap **Save Image**, and the current **Operation** menu shows "Save Image".
- In the **Format** menu item, the available image type can be **".\*png"**, **".\*bmp"**, or **".\*jpg"**.
- Click or tap the ON/OFF tab for **Invert** to enable or disable the invert function.
- Click or tap **"Color"** or **"Gray"** for **Color** to select the desired storage color.

After configuring the settings, press  on the front panel to capture the current screen image and save it based on your settings of the image to be saved. The storage path is where you set the **File Path** under the **Storage** menu. For the settings of the storage path, refer to descriptions in *To Save a File*.

### To Save Wave

- Click or tap **Save Wave**, and the current **Operation** menu shows "Save Wave".
- Click or tap to select "**Memory**", "**Screen**", or "**Record**" (only available when Record function is enabled and recorded waveforms are available) under **Data Source** as the source of waveforms to be saved.
- The available choices under **Format** include "\*.bin" and "\*.csv".

After configuring the settings, press  on the front panel to capture the current waveform and save it based on your settings of the waveforms to be saved. The storage path is where you set the **File Path** under the **Storage** menu. For the settings of the storage path, refer to descriptions in *To Save a File*.

### Save Setup

Click or tap **Save Setup**, and the current **Operation** menu shows "Save Setup".

After configuring the settings, press  on the front panel to save the current settings of the oscilloscope as a file suffixed with "\*.stp". The storage path is where you set the **File Path** under the **Storage** menu. For the settings of the storage path, refer to descriptions in *To Save a File*.

### To Perform All Measurement

- Click or tap **All Measure**, and the current **Operation** menu shows "All Measure".
- The available channels under **All Measure** are CH1 to CH8.

After configuring the settings, press  on the front panel to perform the measurement for the specified channel.

### To Reset Statistics

- Click or tap **Stat Reset**, and the current **Operation** menu shows "Stat Reset".
- Under **Stat Reset**, click or tap "Measure" or "Pass/Fail" to reset the statistics of the specified function.

After configuring the settings, press  on the front panel to reset the result list of the specified function. Then the instrument restarts to make statistics.

### To Record Waveforms

Click or tap **Record**, and the current **Operation** menu shows "Record".

After configuring the settings, press  on the front panel to record the waveforms.

### To Save Group

- Click or tap **Save Group**, and the current **Operation** menu shows "Save Group".
- Under **Save Group**, select one or multiple items from "**Save Image**", "**Save Wave**", and "**Save Setup**".

After configuring the settings, press  on the front panel to save the specified type based on your choice. The storage path is where you set the **File Path** under the **Storage** menu. For the settings of the storage path, refer to descriptions in *To Save a File*.

## 25.9 Self-check

In the **Utility** menu, click or tap **Self Check** to enter the sub-menus of "Self Check". You can test the following self-check items for the device.

### Key Test

Click or tap **Key Test** to enter the key test interface (virtual front panel key), as shown in the figure below.

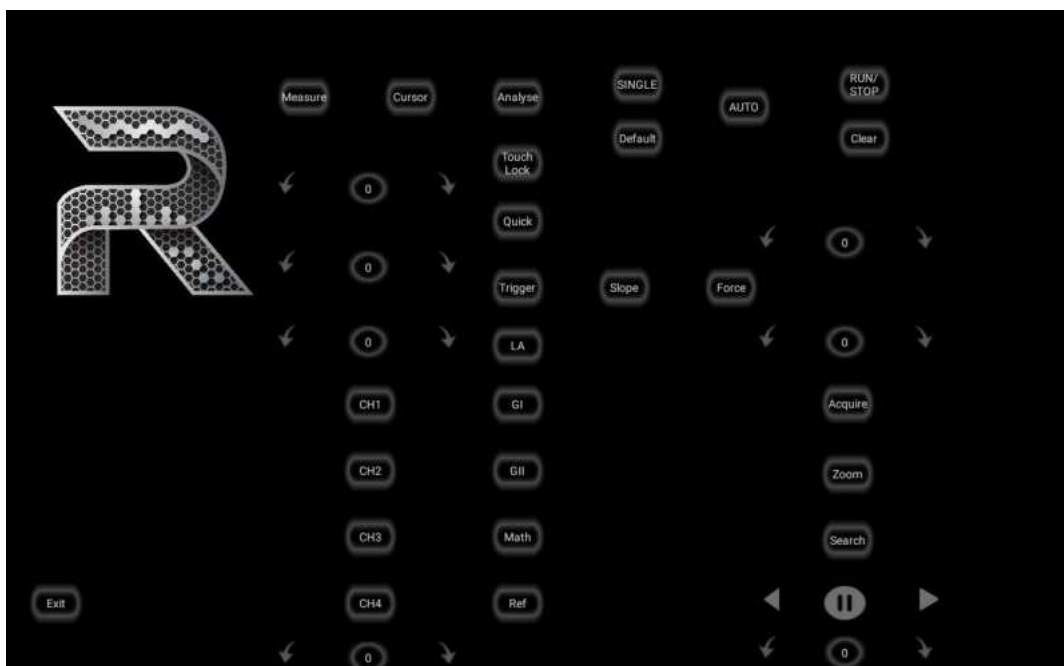



Figure 25.2 Key Test Interface

At this time, you can press the keys on the front panel to check whether the virtual keys are highlighted. If yes, it indicates that the keys work normally; if no, it indicates that there's something wrong with the keys. If the virtual key is not illuminated, the key may fail to work. Click or tap **Exit** at the lower-left corner of the key test interface

to exit the key test interface. You can also press  on the front panel for three consecutive times to exit the key test interface.

### Touch Test

Click or tap **Touch Test** to enter the touch screen test interface, as shown in the figure below.

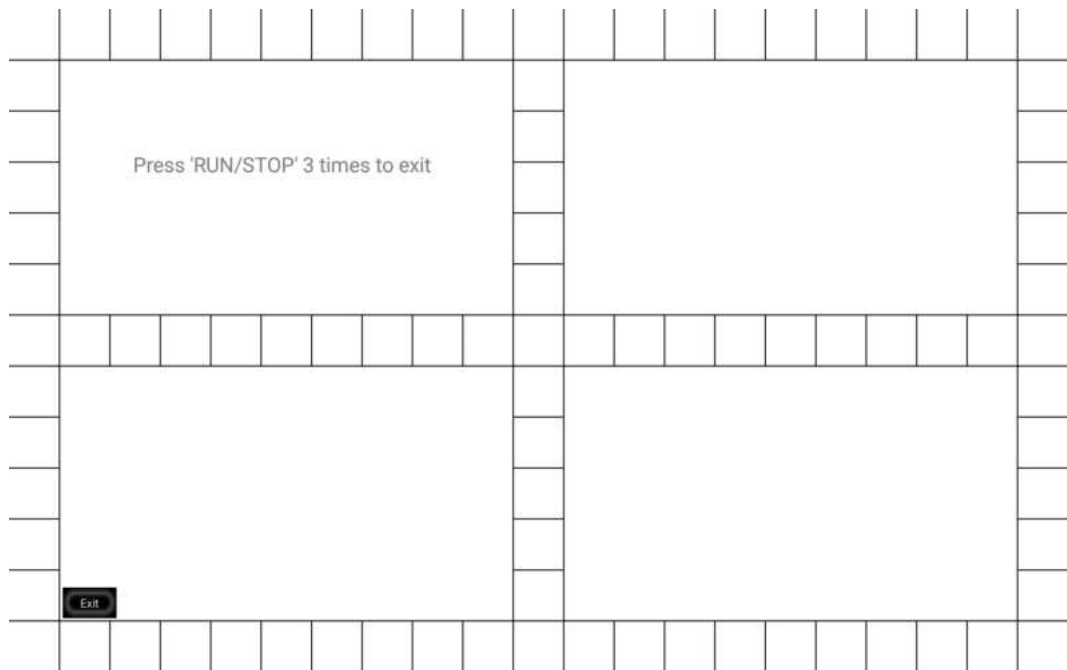

**Figure 25.3 Touch Screen Test Interface**

Slide with your finger on the screen. If there is a line displaying at the empty area where you slide on the screen and the box that you tap turns out to be filled with green background, it indicates that the touch function of this area is normal. Click or tap **Exit** at the lower-left corner of the touch screen test interface to exit the touch

screen test interface. You can also press  on the front panel for three consecutive times to exit the touch screen test interface.

### Screen Test

Click or tap **Screen Test** to enter the screen test interface and check whether the defective pixel exists.

There are 15 colors of test screens. Click on the screen to go to the next screen test interface. Click or tap **Exit** at the upper-left corner of the touch screen test interface to

exit the touch screen test interface. You can also press  on the front panel for three consecutive times to exit the touch screen test interface.

### Board Test

Click or tap **Board Test**, then the board test interface is displayed. Check whether the status of each module is in good condition.

## 26 Remote Control

The following ways of remote control are supported:

- **User-defined Programming**

Users can program and control the instrument by using the SCPI (Standard Commands for Programmable Instruments) commands. For details about the SCPI commands and programming, refer to *Programming Guide* of this product series.

- **PC Software**

Users can use the PC software to send commands to control the instrument remotely. RIGOL Ultra Sigma is recommended. You can download the software from RIGOL official website (<http://www.rigol.com>).

**Operation Procedures:**

- Set up communication between the instrument and PC.
- Run Ultra Sigma and search for the instrument resource.
- Open the remote command control panel to send commands.

- **Web Control**

This instrument supports Web Control. Connect the instrument to the network, then input the IP address of the instrument into the address bar of the browser of your computer. The web control interface is displayed. Click Web Control to enter the web control page. Then you can view the display of the real-time interface of the instrument. Through the Web Control method, you can migrate the device control to the control terminals (e.g. PC, Mobile, iPad, and other smart terminals) to realize remote control of the instrument.

This instrument can be connected to the PC via the USB, LAN, or GPIB interface to set up communication and realize remote control through the PC. The remote control can be realized by using SCPI (Standard Commands for Programmable Instruments) commands.

This chapter will illustrate how to use the RIGOL Ultra Sigma software to remotely control the instrument via various interfaces. Note: When communicating with the PC via GPIB, the instrument does not support large data transmission operation such as screen shot and waveform reading.

**CAUTION**

**Before connecting the communication cable, please turn off the instrument to avoid causing damage to the communication interfaces.**



## 26.1 Remote Control via USB

---

### 1. Connect the device

Use the USB cable to connect the rear-panel USB DEVICE interface of the instrument to the USB HOST interface of the PC.

### 2. Search for the device resource

Start up Ultra Sigma and the software will automatically search for the resource currently connected to the PC via the USB interface. You can also click **USB-TMC** to search for the resource.

### 3. View the device resource

The resources found will appear under the "RIGOL Online Resource" directory, and the model number and USB interface information of the instrument will also be displayed.

### 4. Control the instrument remotely

Right-click the device resource name and select "SCPI Panel Control" to open the remotely command control panel. Then you can send commands and read data through the panel. For details about the SCPI commands and programming, refer to the Programming Guide of this instrument.

## 26.2 Remote Control via LAN

---

### 1. Connect the device

Use the network cable to connect the instrument to your local area network (LAN).

### 2. Configure network parameters

Configure the network parameters of the instrument in **Utility>IO** menu.

### 3. Search for Search device resource

Start up Ultra Sigma and click **LAN** to open the panel as shown in the figure below. Click **Search** and the software searches for the instrument resources currently connected to the LAN and the resources found are displayed at the right section of the window as shown in the figure below. Click **OK** to add it.



Besides, you can input the IP address of the instrument manually into the text field under "Manual Input LAN Instrument IP", then click **TEST**. If the instrument passes the test, click **Add** to add the instrument to the LAN instrument resource list in the right section; if the instrument fails the test, please check whether the IP address that you input is correct, or use the auto search method to add the instrument resource.

#### 4. View the device resource

The resources found will appear under the "RIGOL Online Resource" directory.

#### 5. Control the instrument remotely

Right-click the device resource name and select "SCPI Panel Control" to open the remotely command control panel. Then you can send commands and read data through the panel.

#### 6. Load LXI webpage

As this instrument conforms to LXI CORE 2011 DEVICE standards, you can load LXI web page through Ultra Sigma (right-click the instrument resource name and select "LXI-Web"). Various important information about the instrument (including the model, manufacturer, serial number, description, MAC address, and IP address) will be displayed on the web page. You can also directly input the IP address of the instrument in the address bar of the PC browser to load the LXI web page.

## 26.3 Remote Control via GPIB

### 1. Connect the device

Use the USB-GPIB interface converter to extend the GPIB interface for the instrument, and then use the GPIB cable to connect the instrument to the PC to realize remote control.

### 2. Install the driver of GPIB card

Correctly install the driver of the GPIB card which has been connected to the PC.

### 3. Set the GPIB address

Click or tap the Notification Area at the lower-right corner of the screen, then the **Utility** menu is displayed. Click or tap **IO**, and then click or tap the input field of **GPIB** to input the GPIB address with the pop-up numeric keypad.

#### 4. Search for the device resource

Start Ultra Sigma, and then click **GPIB**. A window is displayed as shown in *Figure 26.1*. Click **Search** and the software searches for the instrument resource currently connected to the PC via the GPIB interface. The resource found is displayed at the right side of the window, as shown in *Figure 26.2*. Click **OK** to add it.



Figure 26.1 Search for the Available Device



Figure 26.2 Confirm the Available Device

#### 5. View the device resource

Click **OK** to go back to the main interface of Ultra Sigma. The searched instrument resource will be displayed under the directory of "RIGOL Online Resource".

#### 6. Control the instrument remotely

Right-click the device resource name. In the displayed menu, select "SCPI Panel Control" to open the programming command control panel. Then you can input commands to send commands and read data.

## 27 Troubleshooting

---

### 1. When I power on the instrument, the instrument stays black and does not display anything.

- a. Check whether the power supply has been connected correctly.
- b. Check whether the power key is really pressed.
- c. Check whether the fuse is blown. If you need to replace the fuse, use only the specified fuse that conforms to the product.
- d. Restart the instrument after finishing the above inspections.
- e. If the problem still persists, please contact RIGOL.

### 2. No waveform of the signal is displayed on the screen.

- a. Check whether the probe is properly connected to the item under test.
- b. Check whether there are signals generated from the item to be tested (you can connect the probe compensation output signal to the faulty channel to locate the problem, and then determine whether the channel or the item to be tested has a problem).
- c. Resample the signal.
- d. If the problem still persists, please contact RIGOL.

### 3. The USB storage device cannot be recognized.

- a. Check whether the USB storage device can work normally when connected to other instruments or PC.
- b. Make sure that the USB storage device is FAT32 format and flash type. The instrument doesn't support hardware USB storage device.
- c. After restarting the instrument, insert the USB storage device again to check whether it can work normally.
- d. If the USB storage device still cannot work normally, please contact RIGOL.

### 4. The touch-enabled operation does not work.

- a. Check whether you have locked the touch screen. If yes, unlock the touch screen.
- b. Check whether the screen or your finger is stained with oil or sweat. If yes, please clean the screen or dry your hands.
- c. Check whether there is a strong magnetic field around the instrument. If the instrument is close to the strong magnetic field (e.g. a magnet), please move the instrument away from the magnet field.

**d.** If the problem still persists, please contact RIGOL.

## 28 Appendix

### 28.1 Appendix A: Options and Accessories

| Order Information  | Order No.                          |
|--|------------------------------------|
| <b>Model</b>   |                                    |
| 500 MHz, 4 GSa/s, 12-bit, 4-CH                                       | DHO5054                            |
| 1 GHz, 4 GSa/s, 12-bit, 4-CH   | DHO5104                            |
| 500 MHz, 4 GSa/s, 12-bit, 4+16CH                                     | MHO5054                            |
| 1 GHz, 4 GSa/s, 12-bit, 4+16CH                                       | MHO5104                            |
| 500 MHz, 4 GSa/s, 12-bit, 6+16CH                                     | MHO5056                            |
| 1 GHz, 4 GSa/s, 12-bit, 6+16CH                                       | MHO5106                            |
| 500 MHz, 4 GSa/s, 12-bit, 8-CH                                       | DHO5058                            |
| 1 GHz, 4 GSa/s, 12-bit, 8-CH   | DHO5108                            |
| <b>Standard Accessories</b>  |                                    |
| Power Cord Conforming to the Standard of the Destination Country     | -- --                              |
| USB Cable  | -- --                              |
| DHO5054/DHO5104/MHO5054/MHO5104:<br>Passive HighZ Probe (500 MHz) x4 | RP3500A                            |
| MHO5056/MHO5106: Passive HighZ Probe (500 MHz) x6                    |                                    |
| DHO5058/DHO5108: Passive HighZ Probe (500 MHz) x8                    |                                    |
| <b>Recommended Accessory</b>   |                                    |
| 4 sets of 4-Channel Logic Analyzer Probe for MHO Series              | PLA3204                            |
| <b>Bandwidth Upgrade Option</b>                                      |                                    |
| 500 MHz-1 GHz Upgrade Option   | DHO5004-BWU05T10 (4-channel model) |

| Order Information  | Order No.  |
|--|--|
|  | DHO5008-BWU05T10 (8-channel model)<br>MHO5004-BWU05T10 (4-channel model)<br>MHO5006-BWU05T10 (6-channel model) |
| <b>Protocol Decoding Option</b>  |  |
| CAN/CAN-FD/LIN Bus Trigger and Analysis Option                                   | DHO5000-AUTOA<br>MHO5000-AUTOA   |
| MIL-STD-1553 Bus Trigger and Analysis Option                                     | DHO5000-AEROA<br>MHO5000-AEROA   |
| FlexRay Serial Bus Trigger and Analysis Option                                   | DHO5000-FLEXA<br>MHO5000-FLEXA   |
| I2S Bus Trigger and Analysis Option  | DHO5000-AUDIOA<br>MHO5000-AUDIOA   |
| <b>Optional Accessories</b>  |  |
| Built-in Dual-Channel 50 MHz Function Waveform Generator Option                  | MHO5000-AWG  |
| Power Analysis Option  | DHO5000-PWRA<br>MHO5000-PWRA   |
| Function and Application Bundle Option, including AUTOA/AEROA/FLEXA/AUDIOA/PWRA. | DHO5000-BND<br>MHO5000-BND   |

**Note:**

For all the mainframes, accessories, and options, please contact the local office of RIGOL.

## 28.2 Appendix B: Warranty

RIGOL TECHNOLOGIES CO., LTD. (hereinafter referred to as RIGOL) warrants that the product mainframe and product accessories will be free from defects in materials and workmanship within the warranty period. If a product proves defective within the warranty period, RIGOL guarantees free replacement or repair for the defective product.

To get repair service, please contact your nearest RIGOL sales or service office.

There is no other warranty, expressed or implied, except such as is expressly set forth herein or other applicable warranty card. There is no implied warranty of merchantability or fitness for a particular purpose. Under no circumstances shall RIGOL be liable for any consequential, indirect, ensuing, or special damages for any breach of warranty in any case.

## 28.3 Appendix C: Factory Settings

Press  on the front panel, then a message "Restore default settings?" is displayed. Click or tap **OK** to restore the instrument to its factory default settings, as shown in the table below. You can also click or tap **Default** on the quick operation toolbar to restore the instrument to its default settings.

**Table 28.2 Factory Settings**



| Parameter                | Factory Settings |
|--------------------------|------------------|
| <b>Horizontal</b>        |                  |
| Horizontal Scale         | 2 $\mu$ s        |
| Horizontal Position      | 0 s              |
| Delayed Sweep            | OFF              |
| Roll                     | Auto             |
| Fine                     | OFF              |
| Horizontal Expansion     | Center           |
| <b>Acquire</b>           |                  |
| Acquisition Mode         | Normal           |
| Memory Depth             | 10 Kpts          |
| <b>Vertical</b>          |                  |
| CH1                      | ON               |
| CH2                      | OFF              |
| CH3                      | OFF              |
| CH4                      | OFF              |
| CH5                      | OFF              |
| CH6                      | OFF              |
| CH7                      | OFF              |
| CH8                      | OFF              |
| Default selected channel | CH1              |
| Display                  | ON               |
| Impedance                | 1 M $\Omega$     |

| Parameter   | Factory Settings |
|---|------------------|
| Fine  | OFF              |
| Vertical Scale  | 50mV             |
| VOffset   | 0 V              |
| Channel Unit  | [V]              |
| Channel Coupling  | DC               |
| Bias  | 0 V              |
| BW Limit  | OFF              |
| Ch-Ch Skew  | 0 s              |
| Display Label   | OFF              |
| Invert  | OFF              |
| Attenuation   | 1X               |
| <b>Trigger</b>  |                  |
| Trigger Type  | Edge Trigger     |
| Trigger Mode  | Auto             |
| Source Selection  | CH1              |
| Trigger Level   | 0V               |
| Edge Type   | Rising           |
| Trigger Coupling  | DC               |
| Trigger Holdoff   | 8 ns             |
| Noise Rejection   | OFF              |
| <b>Display</b>  |                  |
| Display Type  | Vector           |
| Persistence Time  | Min              |
| Intensity   | 50%              |
| Grid  | FULL             |
| Grid Brightness   | 50%              |
| Window Transparency   | 50%              |
| Cursor Brightness   | 80%              |
| Show Scale  | ON               |
| Color Grade   | OFF              |
| Waveform Freeze   | ON               |
| <b>Dual-channel Function/Arbitrary Waveform Generator (AFG)<sup>[1]</sup></b> |                  |
| Channel Output  | OFF              |
| GI Waveform Type  | Sine             |
| Freq  | 1 GHz            |
| Amplitude   | 5V               |

| Parameter                                | Factory Settings |
|--|------------------|
| Offset                                   | 0 V              |
| Start Phase                              | 0°               |
| Modulation State                         | OFF              |
| Modulating Waveform                      | Sine             |
| Modulation Depth                         | 100%             |
| Modulation Frequency                     | 100 MHz          |
| <b>Logic Analyzer (LA)<sup>[2]</sup></b> |                  |
| Select                                   | N/A              |
| D15-D12                                  | Off              |
| D11-D8                                   | Off              |
| D7-D4                                    | Off              |
| D3-D0                                    | Off              |
| Wave Size                                | Medium           |
| Arrange                                  | D15-D0           |
| <b>Bode Plot<sup>[3]</sup></b>           |                  |
| Bode Plot                                | OFF              |
| Input Source                             | CH1              |
| Output Source                            | CH2              |
| AFG Channel                              | AFG1             |
| Output Impedance                         | HighZ            |
| Sweep Type                               | Log              |
| Display Type                             | Waveform         |
| Start Freq                               | 10 Hz            |
| Stop Freq                                | 1 MHz            |
| Points/Decade                            | 10               |
| Output Amplitude                         | 200 mV           |
| Var. Amplitude                           | OFF              |
| <b>Measure</b>                           |                  |
| Threshold                                | OFF              |
| Histogram                                | OFF              |
| Indicator                                | OFF              |
| Statistics                               | OFF              |
| Count                                    | 1,000            |
| Display Type                             | %                |
| Source                                   | CH1              |
| Upper                                    | 90%              |

| Parameter                    | Factory Settings |
|------------------------------|------------------|
| Vmid                         | 50%              |
| Lower                        | 10%              |
| Amplitude Measurement Method | Auto             |
| Region                       | Main             |
| <b>Cursor</b>                |                  |
| Mode                         | Off              |
| <b>Manual</b>                |                  |
| Source                       | CH1              |
| Select                       | X                |
| AX BX                        | OFF              |
| AY                           | -6 $\mu$ s       |
| BY                           | 6 $\mu$ s        |
| <b>Track</b>                 |                  |
| Source A                     | CH1              |
| Source B                     | CH1              |
| AX BX                        | OFF              |
| Track                        | X                |
| AX                           | -6 $\mu$ s       |
| BX                           | 6 $\mu$ s        |
| <b>XY</b>                    |                  |
| Select                       | X                |
| AX BX                        | OFF              |
| AX                           | -150mV           |
| BX                           | 150mV            |
| <b>Frequency Counter</b>     |                  |
| Source                       | CH1              |
| Statistics                   | OFF              |
| Measure                      | Frequency        |
| Resolution                   | 4                |
| <b>DVM</b>                   |                  |
| Source                       | CH1              |
| Mode                         | AC RMS           |
| Beeper                       | OFF              |
| When                         | In Limits        |
| Upper                        | 1 V              |
| Lower                        | 0 V              |
| <b>Save Image</b>            |                  |
| Format                       | *.png            |

| Parameter   | Factory Settings |
|---|------------------|
| Invert  | OFF              |
| Color   | Color            |
| Header  | ON               |
| Overlay   | OFF              |
| <b>Save Wave</b>                                    |                  |
| Data Source   | Screen           |
| Format  | *.bin            |
| <b>Save Setup</b>                                   |                  |
| File Type   | *.stp            |
| <b>Load Setup</b>                                   |                  |
| File Type   | *.stp            |
| <b>System Setting</b>                               |                  |
| Beeper  | OFF              |
| AUX Out   | TrigOut          |
| Input Lock  | OFF              |
| Vertical Expansion                                  | GND              |
| Show Time   | Display          |
| <b>Other Settings Related to the System Utility</b> |                  |
| EXT 10M IN  | OFF              |
| <b>Auto Config</b>                                  |                  |
| Peak to Peak  | ON               |
| Live CH   | OFF              |
| Overlay   | ON               |
| Coupling  | OFF              |
| <b>Quick Settings</b>                               |                  |
| Operation   | Save Image       |
| Format  | *.png            |
| Invert  | OFF              |
| Color   | Color            |
| <b>Pass/Fail Test</b>                               |                  |
| Enable  | OFF              |
| Source  | CH1              |
| Y Mask  | 480 mdiv         |
| X Mask  | 240 mdiv         |
| Format of the Mask File to be Loaded                | *.pf             |

| Parameter                           | Factory Settings  |
|-------------------------------------|---|
| Format of the Mask File to be Saved | *.pf  |
| File Name                           | RigolDS   |
| Aux Output                          | OFF   |
| Pulse                               | 1 $\mu$ s   |
| Output Event                        | Fail  |
| Polarity                            | Positive  |
| Error Action                        | N/A   |
| <b>Power Analysis</b>               |   |
| Enable                              | OFF   |
| Count                               | 500   |
| <b>Power Quality</b>                |   |
| Voltage Channel                     | CH1   |
| Current Channel                     | CH2   |
| Frequency Reference                 | Voltage   |
| Setting Type                        | Percent(%)  |
| Upper                               | 90%   |
| Mid                                 | 50%   |
| Lower                               | 10%   |
| <b>Ripple</b>                       |   |
| Source                              | CH1   |
| <b>Waveform Recording</b>           |   |
| Enable                              | OFF   |
| <b>Record</b>                       |   |
| Interval                            | 10 ns   |
| Frames                              | 1,000   |
| Beeper                              |  |
| <b>Play</b>                         |   |
| Minimize                            | OFF   |
| Play Mode                           |  |
| Play Sequence                       |  |
| Interval                            | 100 ms  |
| <b>Math Operation</b>               |   |
| Invert                              | OFF   |
| Vertical Expansion                  | GND   |
| Display Label                       | OFF   |
| Grid                                | FULL  |
| <b>A+B</b>                          |   |
| Operation                           | OFF   |

| Parameter           | Factory Settings |
|---------------------|------------------|
| SourceA             | CH1              |
| SourceB             | CH1              |
| Scale               | 500 mV           |
| Offset              | 0 V              |
| <b>A-B</b>          |                  |
| Operation           | OFF              |
| SourceA             | CH1              |
| SourceB             | CH1              |
| Scale               | 500 mV           |
| Offset              | 0 V              |
| <b>A×B</b>          |                  |
| Operation           | OFF              |
| SourceA             | CH1              |
| SourceB             | CH1              |
| Scale               | 500 mU           |
| Offset              | 0 U              |
| <b>A÷B</b>          |                  |
| Operation           | OFF              |
| SourceA             | CH1              |
| SourceB             | CH1              |
| Scale               | 500 mU           |
| Offset              | 0 U              |
| <b>FFT</b>          |                  |
| Operation           | OFF              |
| Source              | CH1              |
| X                   | Span-Center      |
| Unit                | dBm/dBV          |
| Center Freq         | 5 MHz            |
| Frequency Range     | 10 MHz           |
| Vertical Scale      | 20 dB            |
| Offset              | 0 dBV            |
| Window Function     | Hanning          |
| Color Grade         | OFF              |
| Peak Search         | OFF              |
| Peak Number         | 5                |
| Threshold           | 5.5 dBV          |
| Excursion           | 1.8 dB           |
| Table Order         | Amp Order        |
| <b>A&amp;&amp;B</b> |                  |
| Operation           | OFF              |
| SourceA             | CH1              |

| Parameter   | Factory Settings |
|-------------|------------------|
| SourceB     | CH1              |
| Wave Size   | Medium           |
| Offset      | 0 div            |
| Sensitivity | 300 mdiv         |
| Thre.CH1    | 0 V              |
| Thre.CH2    | 0 V              |
| Thre.CH3    | 0 V              |
| Thre.CH4    | 0 V              |
| Thre.CH5    | 0 V              |
| Thre.CH6    | 0 V              |
| Thre.CH7    | 0 V              |
| Thre.CH8    | 0 V              |
| <b>A  B</b> |                  |
| Operation   | OFF              |
| SourceA     | CH1              |
| SourceB     | CH1              |
| Wave Size   | Medium           |
| Offset      | 0 div            |
| Sensitivity | 300 mdiv         |
| Thre.CH1    | 0 V              |
| Thre.CH2    | 0 V              |
| Thre.CH3    | 0 V              |
| Thre.CH4    | 0 V              |
| Thre.CH5    | 0 V              |
| Thre.CH6    | 0 V              |
| Thre.CH7    | 0 V              |
| Thre.CH8    | 0 V              |
| <b>A^B</b>  |                  |
| Operation   | OFF              |
| SourceA     | CH1              |
| SourceB     | CH1              |
| Wave Size   | Medium           |
| Offset      | 0 div            |
| Sensitivity | 300 mdiv         |
| Thre.CH1    | 0 V              |
| Thre.CH2    | 0 V              |
| Thre.CH3    | 0 V              |
| Thre.CH4    | 0 V              |
| Thre.CH5    | 0 V              |
| Thre.CH6    | 0 V              |
| Thre.CH7    | 0 V              |

| Parameter   | Factory Settings |
|-------------|------------------|
| Thre.CH8    | 0 V              |
| <b>!A</b>   |                  |
| Operation   | OFF              |
| SourceA     | CH1              |
| Wave Size   | Medium           |
| Offset      | 0 div            |
| Sensitivity | 300 mdiv         |
| Thre.CH1    | 0 V              |
| Thre.CH2    | 0 V              |
| Thre.CH3    | 0 V              |
| Thre.CH4    | 0 V              |
| Thre.CH5    | 0 V              |
| Thre.CH6    | 0 V              |
| Thre.CH7    | 0 V              |
| Thre.CH8    | 0 V              |
| <b>Intg</b> |                  |
| Operation   | OFF              |
| Source      | CH1              |
| Scale       | 500 mV*s         |
| Offset      | 0 V*s            |
| Bias        | 0 V              |
| <b>Diff</b> |                  |
| Operation   | OFF              |
| Source      | CH1              |
| Scale       | 500 mV/s         |
| Offset      | 0 V/s            |
| Smooth      | 5                |
| <b>Sqrt</b> |                  |
| Operation   | OFF              |
| Source      | CH1              |
| Scale       | 500 mU           |
| Offset      | 0 U              |
| <b>Lg</b>   |                  |
| Operation   | OFF              |
| Source      | CH1              |
| Scale       | 500 mU           |
| Offset      | 0 U              |
| <b>Ln</b>   |                  |
| Operation   | OFF              |
| Source      | CH1              |
| Scale       | 500 mU           |

| Parameter        | Factory Settings |
|------------------|------------------|
| Offset           | 0 U              |
| <b>Exp</b>       |                  |
| Operation        | OFF              |
| Source           | CH1              |
| Scale            | 500 mU           |
| Offset           | 0 U              |
| <b>Abs</b>       |                  |
| Operation        | OFF              |
| Source           | CH1              |
| Scale            | 500 mV           |
| Offset           | 0 V              |
| <b>Low Pass</b>  |                  |
| Operation        | OFF              |
| Source           | CH1              |
| Scale            | 500 mV           |
| Offset           | 0 V              |
| $\omega c$       | 4 kHz            |
| <b>High Pass</b> |                  |
| Operation        | OFF              |
| Source           | CH1              |
| Scale            | 500 mV           |
| Offset           | 0 V              |
| $\omega c$       | 4 kHz            |
| <b>Band Pass</b> |                  |
| Operation        | OFF              |
| Source           | CH1              |
| Scale            | 500 mV           |
| Offset           | 0 V              |
| $\omega c1$      | 4 kHz            |
| $\omega c2$      | 8 kHz            |
| <b>Band Stop</b> |                  |
| Operation        | OFF              |
| Source           | CH1              |
| Scale            | 500 mV           |
| Offset           | 0 V              |
| $\omega c1$      | 4 kHz            |
| $\omega c2$      | 8 kHz            |
| <b>AX+B</b>      |                  |
| Operation        | OFF              |
| Source           | CH1              |
| Scale            | 500 mV           |

| Parameter       | Factory Settings |
|-----------------|------------------|
| Offset          | 0 V              |
| A               | 1                |
| B               | 0                |
| <b>Ref</b>      |                  |
| Current         | Ref1             |
| Source          | CH1              |
| Vertical Scale  | 50 mV            |
| VOffset         | 0 V              |
| Label           | REF1             |
| Label Display   | OFF              |
| Color           | Orange           |
| <b>Decode</b>   |                  |
| Bus Type        | Parallel         |
| Bus Status      | OFF              |
| Format          | Hex              |
| Label           | ON               |
| Event Table     | OFF              |
| <b>Parallel</b> |                  |
| CLK             | OFF              |
| Bus             | CH1              |
| Threshold       | 0V               |
| Endian          | Invert           |
| Polarity        | Positive         |
| <b>RS232</b>    |                  |
| Tx              | CH1              |
| Rx              | OFF              |
| Threshold       | 0 V              |
| Polarity        | Negative         |
| Baud            | 9.6 kbps         |
| Data Bits       | 8 bits           |
| Endian          | LSB              |
| Parity          | None             |
| Stop Bit        | 1 bit            |
| <b>I2C</b>      |                  |
| CLK             | CH1              |
| SCL Thre        | 0V               |
| Data            | CH2              |
| SDA Thre        | 0V               |
| Exchange        | SCL/SDA          |
| R/W             | Without          |

| Parameter          | Factory Settings |
|--------------------|------------------|
| <b>SPI</b>         |                  |
| CLK                | CH1              |
| Threshold          | 0 V              |
| Slope              | Rising           |
| MISO               | CH2              |
| Threshold          | 0 V              |
| MOSI               | OFF              |
| Mode               | Timeout          |
| Timeout Value      | 1 $\mu$ s        |
| Polarity           | Positive         |
| Width              | 8                |
| Endian             | MSB              |
| <b>LIN</b>         |                  |
| Source             | CH1              |
| Threshold          | 0 V              |
| Baud Rate          | 19.2 kbps        |
| Parity             | Without          |
| Version            | Both             |
| <b>CAN</b>         |                  |
| Source             | CH1              |
| Threshold          | 0 V              |
| Signal Type        | CAN_L            |
| Baud               | 1 Mbps           |
| Sample Position    | 50%              |
| CAN-FD Baud        | 1 Mbps           |
| FD Sample Position | 50%              |
| <b>FlexRay</b>     |                  |
| Source             | CH1              |
| Threshold          | 0V               |
| Channel Selection  | A                |
| Baud               | 10 Mbps          |
| Signal Type        | BP               |
| Sample Position    | 50%              |
| <b>I2S</b>         |                  |
| SCLK               | CH1              |
| SCLK Threshold     | 0 V              |
| SCLK Edge          | Rising           |
| WS                 | CH2              |
| WS Threshold       | 0 V              |
| SDA                | CH3              |
| Data Threshold     | 0 V              |

| Parameter     | Factory Settings |
|---------------|------------------|
| Word Size     | 4                |
| Receive       | 4                |
| Alignment     | I2S              |
| WS Low        | Left             |
| Endian        | MSB              |
| Data Polarity | Positive         |
| <b>1553B</b>  |                  |
| Data          | CH1              |
| Threshold     | 0 V              |

**NOTE**

[1]: The AFG function is the optional configuration for MHO5054 and MHO5104 models.

[2]: Digital channels are only supported by MHO5054, MHO5104, MHO5056, and MHO5106.

[3]: The Bode plot function is the standard configuration only for MHO5054 and MHO5104 models.

# Boost Smart World and Technology Innovation

Industrial Intelligent  
Manufacturing



Semiconductors

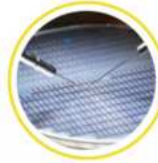

Education &  
Research



Communication

System Integration



New Energy



- 5G Cellular-5G/WIFI
- UWB/RFID/ ZIGBEE
- Digital Bus/Ethernet
- Optical Communication

- Digital/Analog/RF Chip
- Memory and MCU Chip
- Third-Generation Semiconductor
- Solar Photovoltaic Cells

- New Energy Automobile
- PV/Inverter
- Power Test
- Automotive Electronics

Provide Testing and Measuring Products  
and Solutions for Industry Customers

## HEADQUARTER

**RIGOL TECHNOLOGIES CO., LTD.**  
No.8 Keling Road, New District,  
Suzhou, JiangSu, P.R.China  
Tel: +86-400620002  
Email: info@rigol.com

## JAPAN

**RIGOL JAPAN CO., LTD.**  
5F, 3-45-6, Minamiotsuka, Toshima-Ku,  
Tokyo, 170-0005, Japan  
Tel: +81-3-6262-8932  
Fax: +81-3-6262-8933  
Email: info.jp@rigol.com

## EUROPE

**RIGOL TECHNOLOGIES EU GmbH**  
Carl-Benz-Str.11  
82205 Gilching  
Germany  
Tel: +49(0)8105-27292-0  
Email: info-europe@rigol.com

## KOREA

**RIGOL KOREA CO., LTD.**  
5F, 222, Gonghang-daero,  
Gangseo-gu, Seoul, Republic of Korea  
Tel: +82-2-6953-4466  
Fax: +82-2-6953-4422  
Email: info.kr@rigol.com

## NORTH AMERICA

**RIGOL TECHNOLOGIES, USA INC.**  
10220 SW Nimbus Ave.  
Suite K-7  
Portland, OR 97223  
Tel: +1-877-4-RIGOL-1  
Fax: +1-877-4-RIGOL-1  
Email: info@rigol.com