

SAFETY AND USER INSTRUCTIONS

RRC-SMB-2BC Series



www.rrc-ps.com/manualSMB-2BC

FCC Statement, Applicable in U.S.

NOTE: This equipment has been tested and found to comply with the limits for a Class B digital device, pursuant to part 15 of the FCC rules. These limits are designed to provide reasonable protection against harmful interference in a residential installation. This equipment generates, uses and can radiate frequency energy and, if not installed and used in accordance with the instructions, may cause harmful interference to radio communications. However, there is no guarantee that interference will not occur in a particular installation. If this equipment does cause harmful interference to radio or television reception, which can be determined by turning the equipment off and on, the user is encouraged to try to correct the interference by one or more of the following measures:

- Reorient or relocate the receiving antenna.
- Increase the separation between the equipment and the receiver.
- Connect the equipment into an outlet on a circuit different from that to which the receiver is connected.
- Consult the dealer or an experienced radio/TV technician for help.

Changes or modifications not expressly approved by RRC power solutions for compliance could void the user's authority to operate the equipment.



有毒有害物质或元素
中华人民共和国电子信息产品有毒有害物质限量标准
(依据SJ/T11364-2014 为标准)

部件名称	有毒有害物质或元素					
	铅	汞	镉	六价铬	多溴联苯	多溴二苯醚
外壳	0	0	0	0	0	0
螺丝	0	0	0	0	0	0
主集成电路板	X	0	0	0	0	0

0: 表示该有毒有害物质在该部件所有均质材料中的含量均在SJ/T11363-2006 标准规定的限量要求以下

X: 表示该有毒有害物质至少在该部件的某一均质材料中的含量超出SJ/T11363-2006 标准规定的限量要求



客户不可自行更换保险丝, 当保险丝熔断请放弃整个产品

Above information is required by the Chinese authorities as per China environmental regulation (SJ / T11364-2014) and need to be in Chinese language. This information is not applicable in other countries.

SAFETY AND USER INSTRUCTIONS

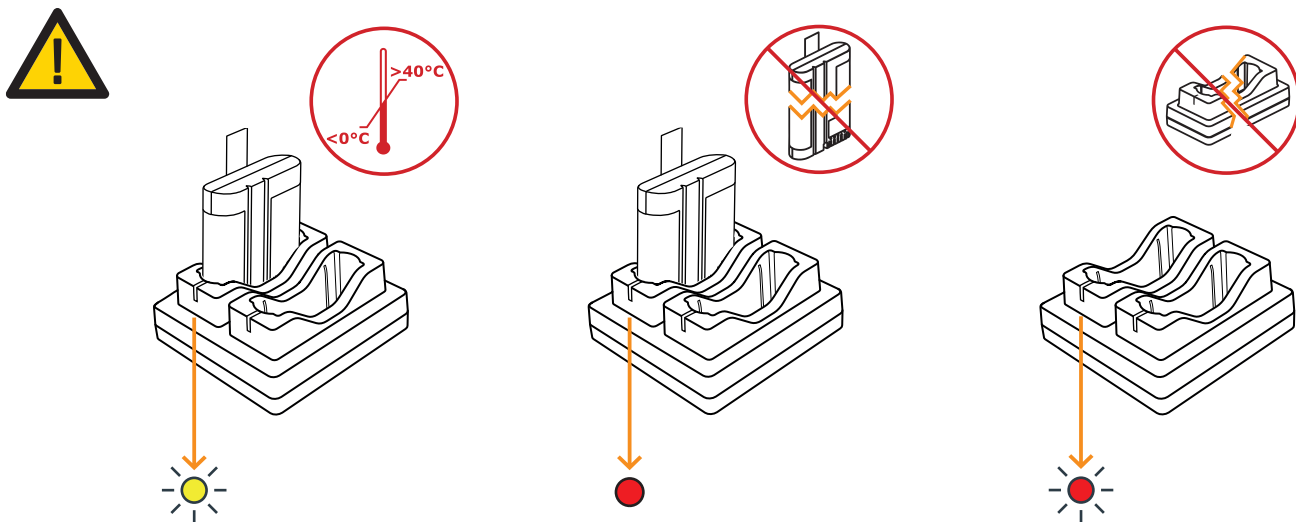
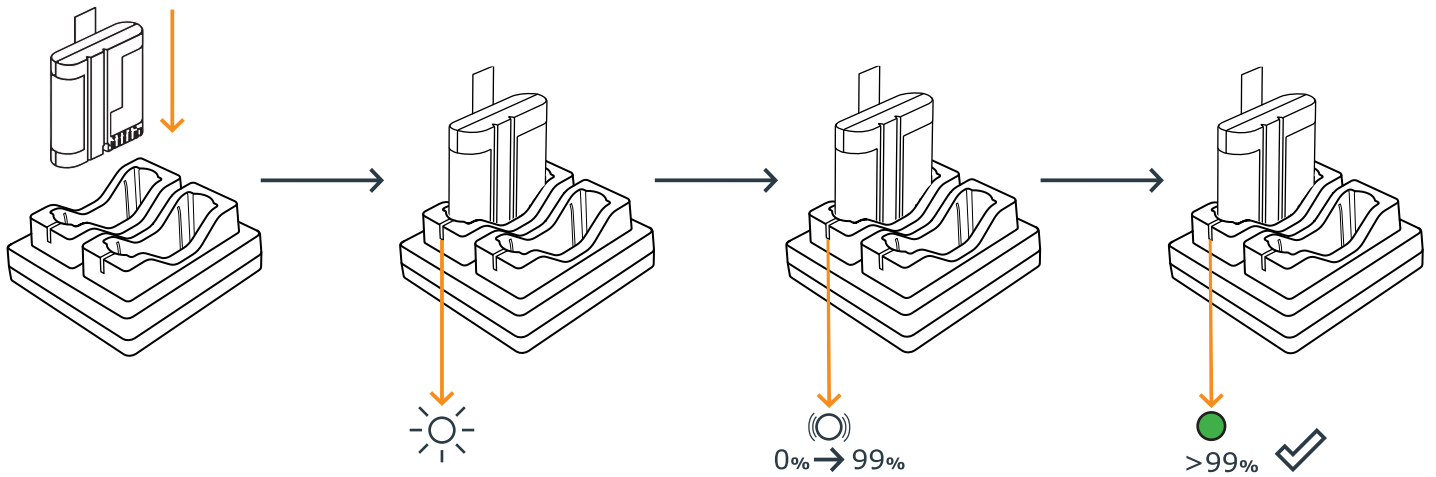
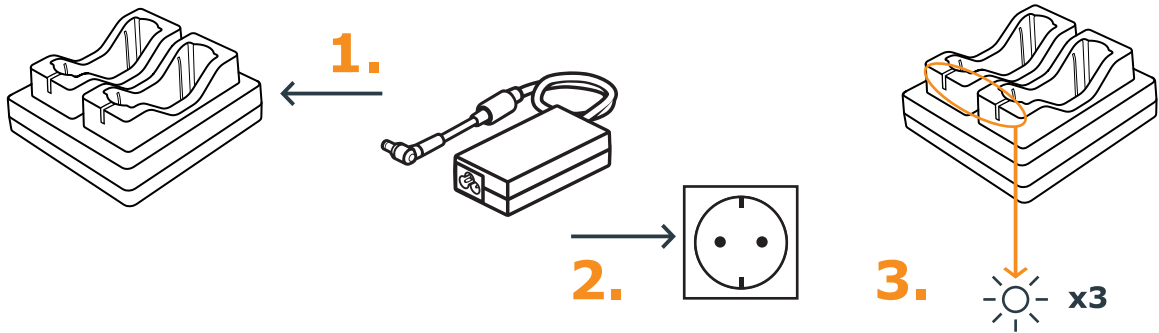
RRC-SMB-2BC Series



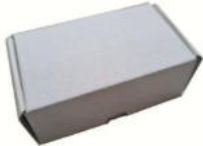
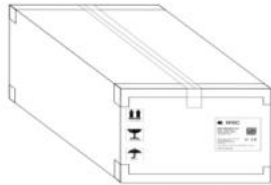











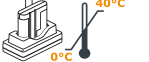

Products	
RRC-SBC2037	RRC-SMB-UBC
RRC-SCC1120	RRC-SMB-UBC-DIS
RRC-SCC1130	RRC-SMB-UBC-M
RRC-SMB-MBC	RRC-SMB-FPC
RRC-SMB-1BC	RRC-SMB-DBC
RRC-SMB-MBC-M	RRC-SMB-2BC
RRC-SMB-HBC	RRC-SMB-4BC
Material	Packaging component
LDPE 4 	PE-Bag 
PAP 20 	Single Box 
	Outer Box 

Pictures only for reference

RRC Standard Battery Charger



Further safety requirements & symbol explanation

- Do not short-circuit the connector.
- Do not drop the charger.
- Only use corresponding RRC power supplies for the chargers.

	Between charger and patient should be at least 1.5m		Do not use defective batteries or a broken connector.
	System for Indoor use only		Do not use defective power supplies.
	The charging temperature range lies between 0° and 40°C.		Do not use a defective charger cradle.
	Do not open or manipulate the charger or power supply.		System for Indoor use only, protection class IP30
	Mark of conformity to applicable European Directives		United Kingdom, UKCA
	Morocco, CMIM		Energy Efficiency product classification: battery charger
	China, RoHS		Dispose of this product according to local regulations.

Permitted operating parameters

Charger	Compatible batteries	Input voltage	Operating temp. Humidity (non-condensing)	Storage temp. Humidity (non-condensing)
RRC-SMB-MBC, RRC-SMB-1BC	RRC203x, RRC204x, RRC205x	19.00 – 26.00VDC	0°C to 40°C 8% to 90% r.H.	-30°C to 80°C 5% to 95% r.H.
RRC-SMB-MBC-M	RRC203x, RRC204x, RRC205x	19.00 – 26.00VDC	0°C to 40°C 20% to 80% r.H.	-20°C to 80°C 10% to 90% r.H.
RRC-SMB-UBC (-DIS)	RRC202x, RRC203x, RRC204x, RRC205x	19.00 – 26.00VDC	0°C to 40°C 8% to 90% r.H.	-30°C to 80°C 5% to 95% r.H.
RRC-SMB-UBC-M	RRC202x, RRC203x, RRC204x, RRC205x	19.00 – 26.00VDC	0°C to 40°C 20% to 80% r.H.	-20°C to 80°C 10% to 90% r.H.
RRC-SMB-FPC	RRC21xx	18.00 – 26.00VDC	0°C to 40°C 8% to 90% r.H.	-30°C to 80°C 5% to 95% r.H.
RRC-SMB-HBC	RRC35xx	19.00 – 24.00VDC	0°C to 40°C 8% to 90% r.H.	-30°C to 80°C 5% to 95% r.H.
RRC-SBC2037	RRC2037	11.00 – 14.00VDC	0°C to 40°C 10% to 90% r.H.	-20°C to 80°C 5% to 95% r.H.
RRC-SMB-DBC	RRC202x, RRC203x, RRC204x, RRC205x	19.00 – 26.00VDC	0°C to 40°C 8% to 90% r.H.	-30°C to 80°C 5% to 95% r.H.
RRC-SMB-2BC, RRC-SMB-4BC	RRC203x, RRC204x, RRC205x	19.00 – 24.00VDC	0°C to 40°C 8% to 90% r.H.	-30°C to 80°C 5% to 95% r.H.
RRC-SCC1120	RRC1120	5.00V nom.	0°C to 40°C 10% to 90% r.H.	-20°C to 80°C 10% to 90% r.H.
RRC-SCC1130	RRC1130	5.00V nom.	0°C to 40°C 10% to 90% r.H.	-20°C to 80°C 10% to 90% r.H.

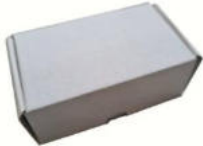
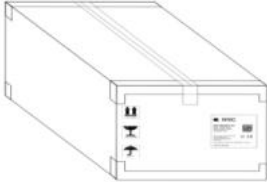
Productos	
RRC-SBC2037	RRC-SMB-UBC
RRC-SCC1120	RRC-SMB-UBC-DIS
RRC-SCC1130	RRC-SMB-UBC-M
RRC-SMB-MBC	RRC-SMB-FPC
RRC-SMB-1BC	RRC-SMB-DBC
RRC-SMB-MBC-M	RRC-SMB-2BC
RRC-SMB-HBC	RRC-SMB-4BC
Material	Componente de embalaje
LDPE 4 	PE-Bag 
PAP 20 	Caja individual 
	Caja exterior 

Fotos sólo como referencia

RRC Cargador de batería estándar



Otros requisitos de seguridad y explicación de los símbolos

- No ponga en cortocircuito el conector.
- No deje caer el cargador.
- Utilice únicamente las fuentes de alimentación RRC correspondientes para los cargadores.

	La distancia entre el cargador y el paciente debe ser de al menos 1,5 m.		No utilice pilas defectuosas ni un conector roto.
	Sistema sólo para uso interior		No utilice fuentes de alimentación defectuosas.
	La temperatura de carga oscila entre 0° y 40°C.		No utilice una base de carga defectuosa.
	No abra ni manipule el cargador ni la fuente de alimentación.		Sistema sólo para uso interior, clase de protección IP30
	Marca de conformidad con las directivas europeas aplicables		Reino Unido, UKCA
	Marruecos, CMIM		Clasificación de productos de eficiencia energética: cargador de baterías
	China, RoHS		Elimine este producto de acuerdo con la normativa local.

Parámetros de funcionamiento permitidos

Cargador	Baterías compatibles	Tensión de entrada	Temp. de funcionamiento Humedad (sin condensación)	Temp. de almacenamiento Humedad (sin condensación)
RRC-SMB-MBC, RRC-SMB-1BC	RRC203x, RRC204x, RRC205x	19.00 – 26.00VDC	0°C to 40°C 8% to 90% r.H.	-30°C to 80°C 5% to 95% r.H.
RRC-SMB-MBC-M	RRC203x, RRC204x, RRC205x	19.00 – 26.00VDC	0°C to 40°C 20% to 80% r.H.	-20°C to 80°C 10% to 90% r.H.
RRC-SMB-UBC (-DIS)	RRC202x, RRC203x, RRC204x, RRC205x	19.00 – 26.00VDC	0°C to 40°C 8% to 90% r.H.	-30°C to 80°C 5% to 95% r.H.
RRC-SMB-UBC-M	RRC202x, RRC203x, RRC204x, RRC205x	19.00 – 26.00VDC	0°C to 40°C 20% to 80% r.H.	-20°C to 80°C 10% to 90% r.H.
RRC-SMB-FPC	RRC21xx	18.00 – 26.00VDC	0°C to 40°C 8% to 90% r.H.	-30°C to 80°C 5% to 95% r.H.
RRC-SMB-HBC	RRC35xx	19.00 – 24.00VDC	0°C to 40°C 8% to 90% r.H.	-30°C to 80°C 5% to 95% r.H.
RRC-SBC2037	RRC2037	11.00 – 14.00VDC	0°C to 40°C 10% to 90% r.H.	-20°C to 80°C 5% to 95% r.H.
RRC-SMB-DBC	RRC202x, RRC203x, RRC204x, RRC205x	19.00 – 26.00VDC	0°C to 40°C 8% to 90% r.H.	-30°C to 80°C 5% to 95% r.H.
RRC-SMB-2BC, RRC-SMB-4BC	RRC203x, RRC204x, RRC205x	19.00 – 24.00VDC	0°C to 40°C 8% to 90% r.H.	-30°C to 80°C 5% to 95% r.H.
RRC-SCC1120	RRC1120	5.00V nom.	0°C to 40°C 10% to 90% r.H.	-20°C to 80°C 10% to 90% r.H.
RRC-SCC1130	RRC1130	5.00V nom.	0°C to 40°C 10% to 90% r.H.	-20°C to 80°C 10% to 90% r.H.

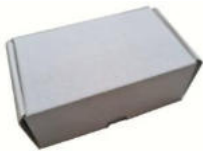
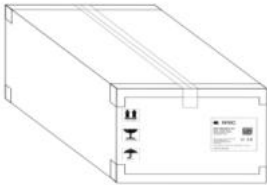











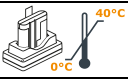

Produits	
RRC-SBC2037	RRC-SMB-UBC
RRC-SCC1120	RRC-SMB-UBC-DIS
RRC-SCC1130	RRC-SMB-UBC-M
RRC-SMB-MBC	RRC-SMB-FPC
RRC-SMB-1BC	RRC-SMB-DBC
RRC-SMB-MBC-M	RRC-SMB-2BC
RRC-SMB-HBC	RRC-SMB-4BC
Matériaux	Éléments d'emballage
LDPE 4 	Sachet polyéthylène 
PAP 20 	Boîte en carton individuelle 
	Boîte en carton extérieure 

Photos à titre indicatif

Chargeurs de batterie standard RRC





Autres exigences de sécurité et explication des symboles

- Ne pas court-circuiter le connecteur.
- Ne pas laisser tomber le chargeur.
- Utiliser uniquement les blocs d'alimentation RRC correspondants aux chargeurs de batteries.

	La distance entre le chargeur et le patient doit être supérieure à 1,5 m.		Ne pas utiliser de batterie ni de connecteur défectueux.
	Système destiné à être utilisé à l'intérieur uniquement		Ne pas utiliser un bloc d'alimentation défectueux.
	La température de recharge est comprise entre 0° et 40°C.		Ne pas utiliser un support de chargeur défectueux.
	Ne pas ouvrir ou manipuler le chargeur ou le bloc d'alimentation.		Système destiné à être utilisé à l'intérieur uniquement, classe de protection IP30.
	Marque de conformité aux directives européennes applicables		Royaume-Uni, UKCA
	Maroc, CMIM		Classe d'efficacité énergétique du produit: Chargeur de batterie
	Chine, RoHS		Jeter ce produit conformément aux réglementations locales.

Paramètres de fonctionnement autorisés:

Chargeur de batteries	Batteries compatibles	Tension d'entrée	Température de fonctionnement Taux d'humidité (sans condensation)	Température de stockage Taux d'humidité (sans condensation)
RRC-SMB-MBC, RRC-SMB-1BC	RRC203x, RRC204x, RRC205x	19.00 – 26.00VDC	0°C to 40°C 8% to 90% r.H.	-30°C to 80°C 5% to 95% r.H.
RRC-SMB-MBC-M	RRC203x, RRC204x, RRC205x	19.00 – 26.00VDC	0°C to 40°C 20% to 80% r.H.	-20°C to 80°C 10% to 90% r.H.
RRC-SMB-UBC (-DIS)	RRC202x, RRC203x, RRC204x, RRC205x	19.00 – 26.00VDC	0°C to 40°C 8% to 90% r.H.	-30°C to 80°C 5% to 95% r.H.
RRC-SMB-UBC-M	RRC202x, RRC203x, RRC204x, RRC205x	19.00 – 26.00VDC	0°C to 40°C 20% to 80% r.H.	-20°C to 80°C 10% to 90% r.H.
RRC-SMB-FPC	RRC21xx	18.00 – 26.00VDC	0°C to 40°C 8% to 90% r.H.	-30°C to 80°C 5% to 95% r.H.
RRC-SMB-HBC	RRC35xx	19.00 – 24.00VDC	0°C to 40°C 8% to 90% r.H.	-30°C to 80°C 5% to 95% r.H.
RRC-SBC2037	RRC2037	11.00 – 14.00VDC	0°C to 40°C 10% to 90% r.H.	-20°C to 80°C 5% to 95% r.H.
RRC-SMB-DBC	RRC202x, RRC203x, RRC204x, RRC205x	19.00 – 26.00VDC	0°C to 40°C 8% to 90% r.H.	-30°C to 80°C 5% to 95% r.H.
RRC-SMB-2BC, RRC-SMB-4BC	RRC203x, RRC204x, RRC205x	19.00 – 24.00VDC	0°C to 40°C 8% to 90% r.H.	-30°C to 80°C 5% to 95% r.H.
RRC-SCC1120	RRC1120	5.00V nom.	0°C to 40°C 10% to 90% r.H.	-20°C to 80°C 10% to 90% r.H.
RRC-SCC1130	RRC1130	5.00V nom.	0°C to 40°C 10% to 90% r.H.	-20°C to 80°C 10% to 90% r.H.

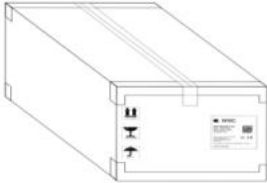











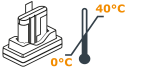

产品	
RRC-SBC2037	RRC-SMB-UBC
RRC-SCC1120	RRC-SMB-UBC-DIS
RRC-SCC1130	RRC-SMB-UBC-M
RRC-SMB-MBC	RRC-SMB-FPC
RRC-SMB-1BC	RRC-SMB-DBC
RRC-SMB-MBC-M	RRC-SMB-2BC
RRC-SMB-HBC	RRC-SMB-4BC
材料	包装部件
LDPE 4 	PE-Bag 
PAP 20 	外盒 
	外箱 

图片仅供参考

RRC 标准电池充电器

进一步的安全要求  符号说明

- 请勿短路连接器
- 请勿跌落充电器。
- 充电器只能使用相应的 RRC 电源。

	充电器与病人之间的距离至少应为 1.5 米		请勿使用有问题的电池或损坏的连接器。
	系统只能在室内使用		不要使用有缺陷的电源。
	充电温度范围为 0°C 至 40°C。		不要使用有缺陷的充电器座。
	请勿打开或滥用充电器或电源。		仅供室内使用的系统，防护等级 IP30
	适用欧洲指令的符合性标志		英国, UKCA
	摩洛哥, CMIM		能源效率产品类别: 电池充电器
	中国, RoHS		此产品根据当地法规处理。

允许的运行参数

电池充电器	兼容电池	输入电压	工作温度 湿度 (无冷凝)	存储温度 湿度 (无冷凝)
RRC-SMB-MBC, RRC-SMB-1BC	RRC203x, RRC204x RRC205x	19.00 – 26.00VDC	0°C to 40°C 8% to 90% r.H.	-30°C to 80°C 5% to 95% r.H.
RRC-SMB-MBC-M	RRC203x, RRC204x RRC205x	19.00 – 26.00VDC	0°C to 40°C 20% to 80% r.H.	-20°C to 80°C 10% to 90% r.H.
RRC-SMB-UBC (-DIS)	RRC202x, RRC203x, RRC204x, RRC205x	19.00 – 26.00VDC	0°C to 40°C 8% to 90% r.H.	-30°C to 80°C 5% to 95% r.H.
RRC-SMB-UBC-M	RRC202x, RRC203x, RRC204x, RRC205x	19.00 – 26.00VDC	0°C to 40°C 20% to 80% r.H.	-20°C to 80°C 10% to 90% r.H.
RRC-SMB-FPC	RRC21xx	18.00 – 26.00VDC	0°C to 40°C 8% to 90% r.H.	-30°C to 80°C 5% to 95% r.H.
RRC-SMB-HBC	RRC35xx	19.00 – 24.00VDC	0°C to 40°C 8% to 90% r.H.	-30°C to 80°C 5% to 95% r.H.
RRC-SBC2037	RRC2037	11.00 – 14.00VDC	0°C to 40°C 10% to 90% r.H.	-20°C to 80°C 5% to 95% r.H.
RRC-SMB-DBC	RRC202x, RRC203x, RRC204x, RRC205x	19.00 – 26.00VDC	0°C to 40°C 8% to 90% r.H.	-30°C to 80°C 5% to 95% r.H.
RRC-SMB-2BC, RRC-SMB-4BC	RRC203x, RRC204x RRC205x	19.00 – 24.00VDC	0°C to 40°C 8% to 90% r.H.	-30°C to 80°C 5% to 95% r.H.
RRC-SCC1120	RRC1120	5.00V nom.	0°C to 40°C 10% to 90% r.H.	-20°C to 80°C 10% to 90% r.H.
RRC-SCC1130	RRC1130	5.00V nom.	0°C to 40°C 10% to 90% r.H.	-20°C to 80°C 10% to 90% r.H.