

SDG8000A series

Arbitrary waveform generator

User Manual

EN01A



SIGLENT TECHNOLOGIES CO., LTD.

Content

1	Introduction	1
2	Important Safety Information	2
2.1	General Safety Summary.....	2
2.2	Safety Terms and Symbols.....	4
2.3	Working Environment.....	5
2.4	Cooling Requirements.....	6
2.5	Power and Grounding Requirements.....	6
2.6	Cleaning.....	7
2.7	Abnormal Conditions.....	8
	Informations	9
	Exigence de Sécurité	9
	Termes et symboles de sécurité	12
	Environnement de travail	13
	Exigences de refroidissement	14
	Connexions d'alimentation et de terre.....	15
	Nettoyage.....	16
	Conditions anormales.....	16
3	Delivery Instrument	17
3.1	Delivery Checklist	17
3.2	Quality Assurance	17
3.3	Maintenance Agreement.....	17
4	Document Conventions	18
5	Introduction of Arbitrary Waveform Generator	19
6	On-off and Option	21
6.1	Power On.....	21
6.2	Power Off.....	21
6.3	Version Information.....	21
6.4	Add Options.....	21
7	Remote Control	22
7.1	Web	22

7.2	Other Remote.....	23
8	Quick Start	24
8.1	Front Panel	24
8.2	Rear Panel	25
9	Screen Display Area	26
10	Front Panel Control	27
10.1	Mode Selection.....	27
10.2	MOD/SWEEP/BURST Selection.....	27
10.3	Numeric Keyboard And Knob.....	27
11	AFG Basic Waveform.....	29
11.1	Standard Waveform.....	29
11.2	Harmonic.....	33
11.3	Noise	35
11.4	PRBS.....	38
11.5	AFG-Arb	41
11.5.1	Arb.....	41
11.5.2	Data Source	41
12	AWG	45
12.1	Add/Insert/Delete/Clear	46
12.2	Save/Recall	47
12.3	Setting.....	48
12.4	Display	50
12.5	Layer.....	52
12.6	Sampling Rate	53
12.7	Mode	53
12.8	Start Scenario/Segment.....	54
12.9	Trigger Mode	54
12.10	Dynamic Jump.....	54
12.11	Wave (Data Source).....	56
12.12	Length.....	58
12.13	Loop	58
12.14	Start.....	58
12.15	Next.....	58

12.16	Wait Event	58
12.17	Playback	59
12.18	Out Event.....	59
12.19	Amplitude.....	60
12.20	Offset	60
12.21	Marker.....	60
13	IQ.....	61
13.1	Working Mode	63
13.2	IQ Balance	64
13.3	IQ Sequence.....	65
13.4	SigIQPro.....	65
14	MOD/SWEEP/BURST.....	66
14.1	Overview.....	66
14.2	Mod	66
14.2.1	Signal Source	67
14.2.2	Modulation Type	68
14.3	Sweep	77
14.3.1	Sweep Type	77
14.3.2	Sweep Mode.....	78
14.3.3	Trigger Source	78
14.3.4	Sweep parameter setting.....	79
14.4	Burst.....	82
14.4.1	Burst Type	82
14.4.2	Trigger Source	82
14.4.3	Burst Parameter Setting	83
15	Hopping.....	88
15.1	Manual	89
15.2	Random Hop.....	90
15.3	Random List.....	91
16	Multitone	93
17	Chirp.....	95
18	Multi Pulse.....	97

19	HSS	99
20	Output Setting	101
21	Multi-Channel	103
21.1	Channel Mode.....	103
21.2	Phase Mode	103
21.3	Channel Combine	104
21.4	Eq-Phase.....	105
21.5	Channel Track	105
21.6	Channel Copy	107
21.7	Channel Coupling.....	108
22	Utility	111
22.1	Setting.....	111
22.1.1	Clock Source	111
22.1.2	Set Clock Output.....	112
22.1.3	Set Trigger Type.....	112
22.1.4	Set Buzzer	112
22.1.5	Set Screen Saver	112
22.1.6	Key Switch.....	113
22.1.7	Language	113
22.1.8	Date/Time	113
22.1.9	Screen Shot.....	113
22.2	Save And Recall	113
22.2.1	Storage System	115
22.2.2	File Type	115
22.2.3	Operation File.....	116
22.3	System Info.....	117
22.4	Interface.....	118
22.4.1	LAN.....	119
22.4.2	Network Storage	121
22.4.3	Sync Signal	122
22.4.4	Input Signal	124
22.4.5	Pattern Edge.....	125
22.4.6	GPIB Settings.....	125

22.4.7	Web Password	125
22.4.8	Device Sync.....	126
22.4.9	VNC Port.....	127
22.4.10	LXI.....	127
22.5	Test/Cal.....	127
22.5.1	Screen Test	128
22.5.2	Key Test	128
22.5.3	LED Test	129
22.5.4	Board Test.....	130
22.5.5	SelfCal/PowerOn Cal	130
22.5.6	TimeBase Cal/PowerOn Timebase	131
22.6	Preset.....	131
22.7	Update	132
22.8	Options	132
22.9	Help	133
22.10	Copyrights.....	133
23	General Inspection and Troubleshooting	134
23.1	General Inspection	134
23.2	Troubleshooting	134
24	Service and Support.....	135
24.1	Warranty summary	135
APPENDIX A		136
APPENDIX B.....		137
APPENDIX C		139

1 Introduction

This user manual includes important safety and installation information related to SDG8000A series arbitrary waveform generators, and includes a simple tutorial on the basic operation of the instrument.

The series includes the following models:

Model	Parameter	Analog Channel
SDG8002A	Maximum output frequency 4 GHz@10 G sampling rate Maximum output frequency 5 GHz@12 G sampling rate	2
SDG8004A	Maximum output frequency 4 GHz@10 G sampling rate Maximum output frequency 5 GHz@12 G sampling rate	4

2 Important Safety Information

This manual contains information and warnings that must be followed by the user for safe operation and to keep the product in a safe condition.

2.1 General Safety Summary

Carefully read the following safety precautions to avoid personal injury and prevent damage to the instrument and any products connected to it. To avoid potential hazards, please use the instrument as specified.

To Avoid Fire or Personal Injury.

Use Proper Power Line.

Only use a local/state approved power cord for connecting the instrument to mains power sources.

Ground the Instrument.

The instrument grounds through the protective ground conductor of the power line. To avoid electric shock, the ground conductor must be connected to the earth. Make sure the instrument is grounded correctly before connect its input or output terminals.

Connect the Signal Wire Correctly.

The potential of the signal wire is equal to the earth, so do not connect the signal wire to a high voltage. Do not touch the exposed contacts or components.

Review All Terminals' Ratings.

To avoid fire or electric shock, please look over all ratings and signed instructions of the instrument. Before connecting the instrument, please read the manual carefully to gain more information about the ratings.

Equipment Maintenance and Service.

When the equipment fails, please do not dismantle the machine for maintenance.

The equipment contains capacitors, power supply, transformers, and other energy storage devices, which may cause high voltage damage.

The internal devices of the equipment are sensitive to static electricity, and direct contact is easy to

cause irreparable damage to the equipment.

It is necessary to return to the factory or the company's designated maintenance organization for maintenance.

Be sure to pull out the power supply when repairing the equipment.

Live line operation is strictly prohibited.

The equipment can only be powered on when the maintenance is completed and the maintenance is confirmed to be successful.

Identification of Normal State of Equipment.

After the equipment is powered on, there will be no alarm information and error information at the interface under normal conditions.

You need to view the specific prompt information.

You can try to restart the setting. If the fault information is still in place, do not use it for testing.

Contact the manufacturer or the maintenance department designated by the manufacturer to carry out maintenance to avoid the wrong test data caused by the use of the fault or endanger the personal safety.

Not Operate with Suspected Failures.

If you suspect that there is damage to the instrument, please let qualified service personnel check it.

Avoid Circuit or Wire Exposed Components Exposed.

Do not touch exposed contacts or components when the power is on.

Do not operate in wet/damp conditions.

Do not operate in an explosive atmosphere.

Keep the surface of the instrument clean and dry.









Not to use the equipment for measurements on mains circuits, not to use the equipment for measurements on voltage exceed the voltage range describe in the manual. The maximum additional transient voltage cannot exceed 1300 V.

The responsible body or operator should refer to the instruction manual to preserve the protection afforded by the equipment. If the equipment is used in a manner not specified by the manufacturer, the protection provided by the equipment may be impaired.

Any parts of the device and its accessories are not allowed to be changed or replaced, other than authorized by the manufacturer or agent.

2.2 Safety Terms and Symbols

When the following symbols or terms appear on the front or rear panel of the instrument or in this manual, they indicate special care in terms of safety.

	This symbol is used where caution is required. Refer to the accompanying information or documents to protect against personal injury or damage to the instrument.
	This symbol warns of a potential risk of shock hazard.
	This symbol is used to denote the measurement ground connection.
	This symbol is used to denote a safety ground connection.
	This symbol shows that the switch is an On/Standby switch. When it is pressed, the scope's state switches between Operation and Standby. This switch does not disconnect the device's power supply. To completely power off the scope, the power cord must be unplugged from the AC socket after the instrument is in the standby state.
	This symbol is used to represent alternating current, or "AC".
	The " CAUTION " symbol indicates a potential hazard. It calls attention to a procedure, practice, or condition which may be dangerous if not followed. Do not proceed until its conditions are fully understood and met.
	The " WARNING " symbol indicates a potential hazard. It calls attention to a procedure, practice, or condition which, if not followed, could cause bodily injury or death. If a WARNING is indicated, do not proceed until the safety conditions are fully understood and met.

2.3 Working Environment

The design of the instrument has been verified to conform to EN 61010-1 safety standard per the following limits:

Environment

The instrument is used indoors and should be operated in a clean and dry environment with an ambient temperature range.

Note: Direct sunlight, electric heaters, and other heat sources should be considered when evaluating the ambient temperature.



Do not operate the instrument in explosive, dusty, or humid environments.

Ambient Temperature

Operating: 0 °C to +50 °C

Non-operation: -20 °C to +60 °C

Note: Direct sunlight, radiators, and other heat sources should be taken into account when assessing the ambient temperature.

Humidity

Operating: 5% ~ 90%RH at ≤30°C and reduced to 5% ~ 50%RH at 50°C

Non-operating: 5% ~ 95% RH

Mains supply voltage fluctuations

Refer to 2.5 Power and Grounding Requirements

Altitude

Operating: ≤3,048 m, 30 °C

Non-operating: ≤15,000 m

Installation (overvoltage) category: Category II (mains connector) and Category I (measuring

terminal)

Note: Installation (overvoltage) category I refers to the signal level, which is suitable for connecting to the equipment measuring terminal in the source circuit, in which measures have been taken to limit the instantaneous voltage to a corresponding low level.

Installation (overvoltage) category II refers to the local distribution level, which is suitable for devices connected to the mains (AC power supply).

Pollution degree: Class 2

Note: Pollution degree 2 refers to the working environment where only dry and non-conductive pollution occurs. Sometimes it is necessary to predict the temporary conductivity caused by concentration.

IP Rating

IP20 (as defined in IEC 60529).

2.4 Cooling Requirements

This instrument relies on the forced air cooling with internal fans and ventilation openings. Care must be taken to avoid restricting the airflow around the apertures (fan holes) at each side of the scope. To ensure adequate ventilation it is required to leave a 15 cm (6 inch) minimum gap around the sides of the instrument.



Do not block the ventilation holes located on both sides of the scope.

Do not allow any foreign matter to enter the scope through the ventilation holes, etc.

2.5 Power and Grounding Requirements

The instrument operates under a 50/60 Hz(+/-10%) single-phase 100 to 240 Vrms(+/-10%) AC power supply.

Because the instrument automatically adapts to the line voltage, there is no need to manually select the voltage.

Depending on the type and quantity of options and accessories (PC port plug-ins, etc.), the instrument can consume up to 350 W of power.

The instrument includes a set of grounding wires, two grounding holes in front, and banana plugs. The AC input ground terminal is directly connected to the instrument frame. In order to fully prevent the danger of electric shock, the power cord plug must be inserted into the matching AC socket with safety grounding contact. Only use the power cord specified by this instrument and be certified in the country/region where it is used.

⚠ WARNING

Electrical Shock Hazard!

Any interruption of the protective conductor inside or outside of the scope, or disconnection of the safety ground terminal creates a hazardous situation.

Intentional interruption is prohibited.

The location of the instrument should be convenient to access the socket. To completely power off the instrument, please unplug the instrument power cord from the AC outlet.

If the signal source is not used for a long time, unplug the power cord from the AC outlet.

⚠ CAUTION

Each terminal housing of the front/rear panel is connected to the equipment casing, and then connected to the safety ground.

2.6 Cleaning

Use only a damp and soft cloth to clean the outside of the instrument. Do not use chemicals or abrasives. Under no circumstances are moisture allowed to penetrate into the instrument. To avoid electric shock, please unplug the power cord from the AC outlet before cleaning.

⚠ WARNING

Electrical Shock Hazard!

No operator serviceable parts inside. Do not remove covers.

Refer servicing to qualified personnel.

2.7 Abnormal Conditions

Do not operate the signal source if there are any visible signs of damage or severe transportation stress.

If you suspect that the protection function of the signal source is damaged, please disconnect the power cord and fix the instrument to prevent accidental operation.

The correct use of the instrument depends on reading all the instructions and labels carefully.



Using the signal source in a way not specified by the manufacturer may damage the safety protection of the instrument. The instrument should not be directly connected to human subjects or used for patient monitoring.

Informations

Ce manuel contient des informations et des avertissements que les utilisateurs doivent suivre pour assurer la sécurité des opérations et maintenir les produits en sécurité.

Exigence de Sécurité

Lisez attentivement les précautions de sécurité ci - après afin d'éviter les dommages corporels et de prévenir les dommages aux instruments et aux produits associés. Pour éviter les risques potentiels, utilisez les instruments prescrits.

Éviter l'incendie ou les lésions corporelles.

Utilisez un cordon d'alimentation approprié.

N'utilisez que des cordons d'alimentation spécifiques aux instruments approuvés par les autorités locales.

Mettez l'instrument au sol.

L'instrument est mis à la Terre par un conducteur de mise à la terre de protection du cordon d'alimentation. Pour éviter un choc électrique, le conducteur de mise à la terre doit être mis à la terre. Assurez - vous que l'instrument est correctement mis à la terre avant de connecter les bornes d'entrée ou de sortie de l'instrument.

Connectez correctement le fil de signalisation.

Le potentiel de la ligne de signal est égal au potentiel au sol, donc ne connectez pas la ligne de signal à haute tension. Ne touchez pas les contacts ou les composants exposés.

Voir les cotes de tous les terminaux.

Pour éviter un incendie ou un choc électrique, vérifiez toutes les cotes et signez les instructions de l'instrument. Avant de brancher l'instrument, lisez attentivement ce manuel pour obtenir de plus amples renseignements sur les cotes.

Entretien du matériel.

En cas de défaillance de l'équipement, ne pas démonter et entretenir l'équipement sans autorisation.

L'équipement contient des condensateurs, de l'alimentation électrique, des transformateurs et d'autres dispositifs de stockage d'énergie, ce qui peut causer des blessures à haute tension. Les dispositifs internes de l'équipement sont sensibles à l'électricité statique. Le contact direct peut facilement causer des blessures irrécupérables à l'équipement. L'équipement doit être retourné à l'usine ou à l'organisme de maintenance désigné par l'entreprise pour l'entretien. L'alimentation électrique doit être retirée pendant l'entretien. La ligne ne doit pas être mise sous tension tant que l'entretien de l'équipement n'est pas terminé et que l'entretien n'est pas confirmé.

Identification de l'état normal de l'équipement.

Après le démarrage de l'équipement, dans des conditions normales, il n'y aura pas d'information d'alarme et d'erreur au bas de l'interface, et la courbe de l'interface sera balayée librement de gauche à droite; si un blocage se produit pendant le processus de numérisation, ou si l'information d'alarme ou d'erreur apparaît au bas de l'interface, l'équipement peut être dans un état anormal. Pour voir l'information d'alarme spécifique, vous pouvez d'abord essayer de redémarrer. Si l'information sur la défaillance est toujours présente, ne l'utilisez pas pour l'essai. Contactez le fabricant ou le Service de réparation désigné par le fabricant pour effectuer l'entretien afin d'éviter d'apporter des données d'essai erronées ou de mettre en danger la sécurité personnelle en raison de l'utilisation de la défaillance.

Ne pas fonctionner en cas de suspicion de défaillance.

Si vous soupçonnez des dommages à l'instrument, demandez à un technicien qualifié de vérifier.

L'exposition du circuit ou de l'élément d'exposition du fil est évitée.

Lorsque l'alimentation est connectée, aucun contact ou élément nu n'est mis en contact.

Ne pas fonctionner dans des conditions humides / humides.

Pas dans un environnement explosif.

Maintenez la surface de l'instrument propre et sec.

Le Circuit d'alimentation électrique ne peut pas être mesuré à l'aide du dispositif, ni la tension qui dépasse la plage de tension décrite dans le présent manuel.

Seuls les ensembles de sondes conformes aux spécifications du fabricant peuvent être utilisés.









L'organisme ou l'opérateur responsable doit se référer au cahier des charges pour protéger la protection offerte par le matériel. La protection offerte par le matériel peut être compromise si celui-ci est utilisé de manière non spécifiée par le fabricant.

Aucune pièce du matériel et de ses annexes ne peut être remplacée ou remplacée sans l'autorisation de son fabricant.

Remplacer la batterie dans l'appareil avec les mêmes spécifications de batterie au lithium.

Termes et symboles de sécurité

Lorsque les symboles ou termes suivants apparaissent sur le panneau avant ou arrière de l'instrument ou dans ce manuel, ils indiquent un soin particulier en termes de sécurité.

	<p>Ce symbole est utilisé lorsque la prudence est requise. Reportez-vous aux informations ou documents joints afin de vous protéger contre les blessures ou les dommages à l'instrument.</p>
	<p>Ce symbole avertit d'un risque potentiel de choc électrique.</p>
	<p>Ce symbole est utilisé pour désigner la connexion de terre de mesure.</p>
	<p>Ce symbole est utilisé pour indiquer une connexion à la terre de sécurité.</p>
	<p>Ce symbole indique que l'interrupteur est un interrupteur marche / veille. Lorsqu'il est enfoncé, l'état de l'instrument bascule entre Fonctionnement et Veille. Ce commutateur ne déconnecte pas l'alimentation de l'appareil. Pour éteindre complètement l'instrument, le cordon d'alimentation doit être débranché de la prise secteur une fois l'instrument en état de veille.</p>
	<p>Ce symbole est utilisé pour représenter un courant alternatif, ou "AC".</p>
	<p>Le symbole "ATTENTION" indique un danger potentiel. Il attire l'attention sur une procédure, une pratique ou une condition qui peut être dangereuse si elle n'est pas suivie. Ne continuez pas tant que ses conditions n'ont pas été entièrement comprises et remplies.</p>
	<p>Le symbole "AVERTISSEMENT" indique un danger potentiel. Il attire l'attention sur une procédure, une pratique ou une condition qui, si elle n'est pas suivie, pourrait entraîner des blessures corporelles ou la mort. Si un AVERTISSEMENT est indiqué, ne continuez pas tant que les conditions de sécurité ne sont pas entièrement comprises et remplies.</p>

Environnement de travail

La conception de l'instrument a été certifiée conforme à la norme EN 61010-1, sur la base des valeurs limites suivantes:

Environnement

L'instrument doit être utilisé à l'intérieur dans un environnement propre et sec dans la plage de température ambiante.

Note: la lumière directe du soleil, les réchauffeurs électriques et d'autres sources de chaleur doivent être pris en considération lors de l'évaluation de la température ambiante.



Ne pas utiliser l'instrument dans l'air explosif, poussiéreux ou humide.

Température ambiante

En fonctionnement: 0 °C à +50 °C

Hors fonctionnement: -20 °C à +60 °C

Note: pour évaluer la température de l'environnement, il convient de tenir compte des rayonnements solaires directs, des radiateurs thermiques et d'autres sources de chaleur.

Humidité

Fonctionnement: 5% ~ 90% HR, 30 °C, 50 °C réduit à 50% HR
Hors fonctionnement: 5% ~ 95%, 65 °C, 24 heures

Fluctuation de la tension d'alimentation

Voir connexions d'alimentation et au sol

Altitude

Fonctionnement: ≤3048 m

□ l'arrêt: ≤15,000 m

Catégorie d'installation (surtension)

Ce produit est alimenté par une alimentation électrique conforme à l'installation (surtension) Catégorie II.

Installation (overvoltage) Category Definitions Définition de catégorie d'installation (surtension)

La catégorie II d'installation (surtension) est un niveau de signal applicable aux terminaux de mesure d'équipement reliés au circuit source. Dans ces bornes, des mesures préventives sont prises pour limiter la tension transitoire à un niveau inférieur correspondant.

La catégorie II d'installation (surtension) désigne le niveau local de distribution d'énergie d'un équipement conçu pour accéder à un circuit alternatif (alimentation alternative).

Degré de pollution

Un instrument peut être utilisé dans un environnement Pollution Degree II.

Note: Pollution Degree II signifie que le milieu de travail est sec et qu'il y a une pollution non conductrice. Parfois, la condensation produit une conductivité temporaire.

IP Rating

IP20 (as defined in IEC 60529).

Exigences de refroidissement

Cet instrument repose sur un refroidissement à air forcé avec des ventilateurs internes et des ouvertures de ventilation. Des précautions doivent être prises pour éviter de restreindre le flux d'air autour des ouvertures (trous de ventilateur) de chaque côté de la lunette. Pour assurer une ventilation adéquate, il est nécessaire de laisser un espace minimum de 15 cm (6 pouces) sur les côtés de l'instrument.



Ne bloquez pas les trous de ventilation situés des deux côtés de la lunette.

Ne laissez aucun corps étranger pénétrer dans la lunette par les trous de ventilation, etc.

Connexions d'alimentation et de terre

L'instrument fonctionne avec une alimentation CA monophasée de 100 à 240 Vrms (+/- 10%) à 50/60 Hz (+/- 10%).

Aucune sélection manuelle de la tension n'est requise car l'instrument s'adapte automatiquement à la tension de ligne.

Selon le type et le nombre d'options et d'accessoires (sondes, plug-in de port PC, etc.), l'instrument peut consommer jusqu'à 350 W d'énergie.

L'instrument comprend un jeu de cordons mis à la terre contenant une fiche polarisée à trois bornes moulée et un connecteur standard IEC320 (Type C13) pour établir la tension de ligne et la connexion de mise à la terre de sécurité. La borne de mise à la terre de l'entrée CA est directement connectée au châssis de l'instrument. Pour une protection adéquate contre les risques d'électrocution, la fiche du cordon d'alimentation doit être insérée dans une prise secteur correspondante contenant un contact de sécurité avec la terre. Utilisez uniquement le cordon d'alimentation spécifié pour cet instrument et certifié pour le pays d'utilisation.

AVERTISSEMENT

Risque de choc électrique!

Toute interruption du conducteur de terre de protection à l'intérieur ou à l'extérieur de la portée ou la déconnexion de la borne de terre de sécurité crée une situation dangereuse.

L'interruption intentionnelle est interdite.

La position de l'instruments doit permettre un accès facile à la prise. Pour éteindre complètement l'instruments, débranchez le cordon d'alimentation de l'instrument de la prise secteur.

Le cordon d'alimentation doit être débranché de la prise secteur si la lunette ne doit pas être utilisée pendant une période prolongée.

ATTENTION

les enveloppes extérieures des bornes du panneau avant (CH1, CH2) sont connectées au châssis de l'instrument et donc à la terre de sécurité.

Nettoyage

Nettoyez uniquement l'extérieur de l'instrument à l'aide d'un chiffon doux et humide. N'utilisez pas de produits chimiques ou d'éléments abrasifs. Ne laissez en aucun cas l'humidité pénétrer dans l'instrument. Pour éviter les chocs électriques, débranchez le cordon d'alimentation de la prise secteur avant de le nettoyer.

AVERTISSEMENT

Risque de choc électrique!

Aucune pièce réparable par l'opérateur à l'intérieur. Ne retirez pas les capots.

Confiez l'entretien à un personnel qualifié

Conditions anormales

Utilisez l'instrument uniquement aux fins spécifiées par le fabricant.

N'utilisez pas la lunette s'il y a des signes visibles de dommages ou si elle a été soumise à de fortes contraintes de transport.

Si vous pensez que la protection de l'instruments a été altérée, débranchez le cordon d'alimentation et sécurisez l'instrument contre toute opération involontaire.

Une bonne utilisation de l'instrument nécessite la lecture et la compréhension de toutes les instructions et étiquettes.

AVERTISSEMENT

Toute utilisation de l'instruments d'une manière non spécifiée par le fabricant peut compromettre la protection de sécurité de l'instrument. Cet instrument ne doit pas être directement connecté à des sujets humains ni utilisé pour la surveillance des patients.

3 Delivery Instrument

3.1 Delivery Checklist

First, verify that all items listed on the packing list have been delivered. If you note any omissions or damage, please contact your nearest **SIGLENT** customer service center or distributor as soon as possible. If you fail to contact us immediately in case of omission or damage, we will not be responsible for replacement.

3.2 Quality Assurance

The signal source has a 3-year warranty from the date of shipment, during normal use and operation. **SIGLENT** can repair or replace any product that is returned to the authorized service center during the warranty period. We must first examine the product to make sure that the defect is caused by the process or material, not by abuse, negligence, accident, abnormal conditions, or operation.

SIGLENT shall not be responsible for any defect, damage, or failure caused by any of the following:

- a) Attempted repairs or installations by personnel other than **SIGLENT**.
- b) Connection to incompatible devices/incorrect connection.
- c) For any damage or malfunction caused by the use of non-**SIGLENT** supplies. Furthermore, **SIGLENT** shall not be obligated to service a product that has been modified. Spare, replacement parts and repairs have a 90-day warranty.

The signal source firmware has been thoroughly tested and is presumed to be functional. Nevertheless, it is supplied without a warranty of any kind covering detailed performance. Products not made by **SIGLENT** are covered solely by the warranty of the original equipment manufacturer.

3.3 Maintenance Agreement

We provide various services based on maintenance agreements. We offer extended warranties as well as installation, training, enhancement and on-site maintenance, and other services through specialized supplementary support agreements. For details, please consult your local **SIGLENT** customer service center or distributor.

4 Document Conventions

For convenience, text surrounded by a box border is used to represent the button of the front panel. For example, Utility represents the "Utility" button on the front panel. Use italicized text with character shading to represent clickable menus, options, and virtual buttons on the display screen. For example, *Frequency* represents the "Freq" menu on the screen:



For the operations that contain multiple steps, the description is in the form of "Step 1 > Step 2 >...". As an example, follow each step in the sequence to enter the system information interface:

Utility > *System Info*

Press the Utility button on the front panel as step 1, click the *System Info* option on the screen as step 2, You can enter the system information interface.

5 Introduction of Arbitrary Waveform Generator

SDG8000A series function/arbitrary waveform generator, maximum 4 analog output channels, 16-bit vertical resolution, maximum sampling rate of 12 GSa/s (interpolation), maximum output frequency of 5 GHz and maximum modulation bandwidth of 2 GHz. The maximum storage space of 4G sample points per channel provides longer playing time. With SigIQPro, it can also provide waveform output of communication signals such as Bluetooth, WIFI and LTE. Innovative TrueArb and EasyPulse technologies overcome the inherent defects of DDS technology when outputting arbitrary waves and square waves/pulses, and can provide users with high fidelity and lower jitter signals. In addition, SDG8000A also provides high-speed serial code signal (Hss) output, supports complex multi-level serial wave output, and has the functions of double pulse, multi-tone and linear frequency modulation(Chirp) to meet a wider range of test requirements.

The performance characteristics are given below, so that you can have a deeper understanding of the technical indicators of SDG8000A.

- 2/4 channels, the highest output frequency is 4 GHz(10 GSa/s sampling rate) /5 GHz(12 GSa/s sampling rate)
- 16-bit vertical resolution
- With the adoption of TrueArb technology, arbitrary wave can be output point by point, and low jitter waveform can be output with variable sampling rate of 100 Sa/s~5 GSa/s on the premise of not losing waveform details.
- Support multi-level sequence wave playback function, and the maximum storage depth of each channel is 4 Gpts.
- EasyPulse technology can output square waves/pulses with low jitter, and the pulse width and rising/falling edge can be finely adjusted, with extremely high adjustment resolution and adjustment range.
- Supports single-ended and differential output modes.
- Support double pulse output function, which can be used to measure the switching parameters of power equipment and evaluate its dynamic characteristics.
- Support multitoned and chirp.
- It can output the PRBS with the highest bit rate of 1.25 Gbps.
- Rich analog and digital modulation functions:AM、DSB-SC、FM、PM、FSK、ASK、PSK and PWM
- Support sweep and Burst.
- Support harmonic function.
- Support channel combine function.
- It can output vector signals with a bandwidth of up to 2 GHz.

- Support Bluetooth, OFDM, IOT, LTE, WIFI and other signal waveform output.
- Support 198 built-in arbitrary waves
- Rich communication interfaces: standard USB Host, USB Device(USBTMC), LAN(VXI-11), optional GPIB.
- Built-in 250 GByte SSD hard disk.
- The built-in WebServer supports the controller through a web browser.
- Seven-inch color touch screen, HDMI interface supports external display screen.

6 On-off and Option

6.1 Power On

After the signal source is connected to the AC power supply through the power cord, the user needs to manually press the power button to turn on the signal source.

6.2 Power Off

Press and hold the power button for two seconds to turn off the signal source, or turn it off by the following steps:

Utility > Shut Down

Note: The signal source is still in standby state after the power-off button is pressed. If you don't want the signal source to continue to consume power, please unplug the instrument power cord from the AC power socket to completely turn off the instrument power.

6.3 Version Information

The following steps can determine the software and hardware versions:

Utility > System Info

See for details" 22.3 System Info".

6.4 Add Options

In order to add an option, you need an authorization code to activate this option. Please refer to the chapter "22.8 Options" for details.

7 Remote Control

This equipment has LAN port and USB Device port. Based on these two ports, users can realize remote control of the instrument in many ways.

7.1 Web

This device supports users to access and control Instrument through Web browsers. You can set the access password in the web service interface. Users can access the signal source by entering the IP address of the Instrument in the browser address bar.

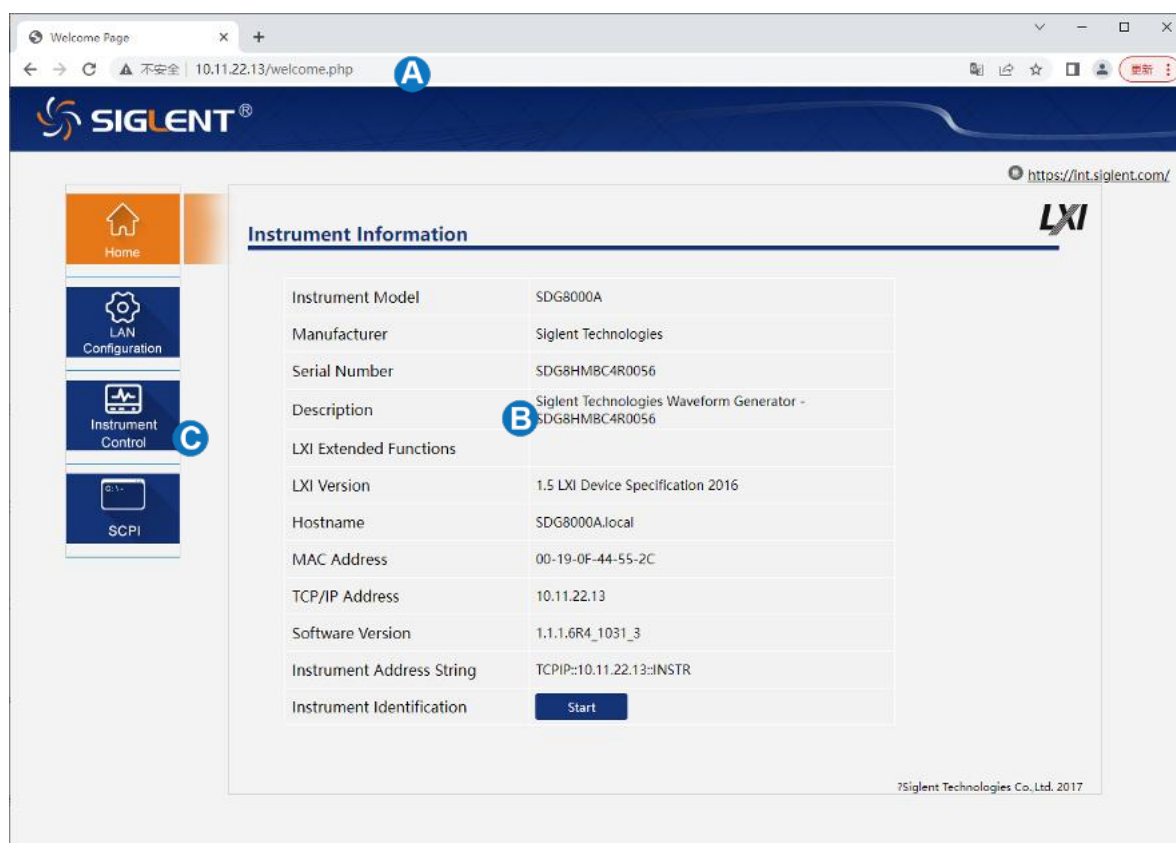

- A. The browser types the IP address of the instrument.
- B. Instrument information displayed by default after entering the home page.
- C. Click here to enter the instrument control interface.

For the IP address setting of instrument, please refer to the section “22.4.1LAN” for details.

The instrument control interface is shown below:

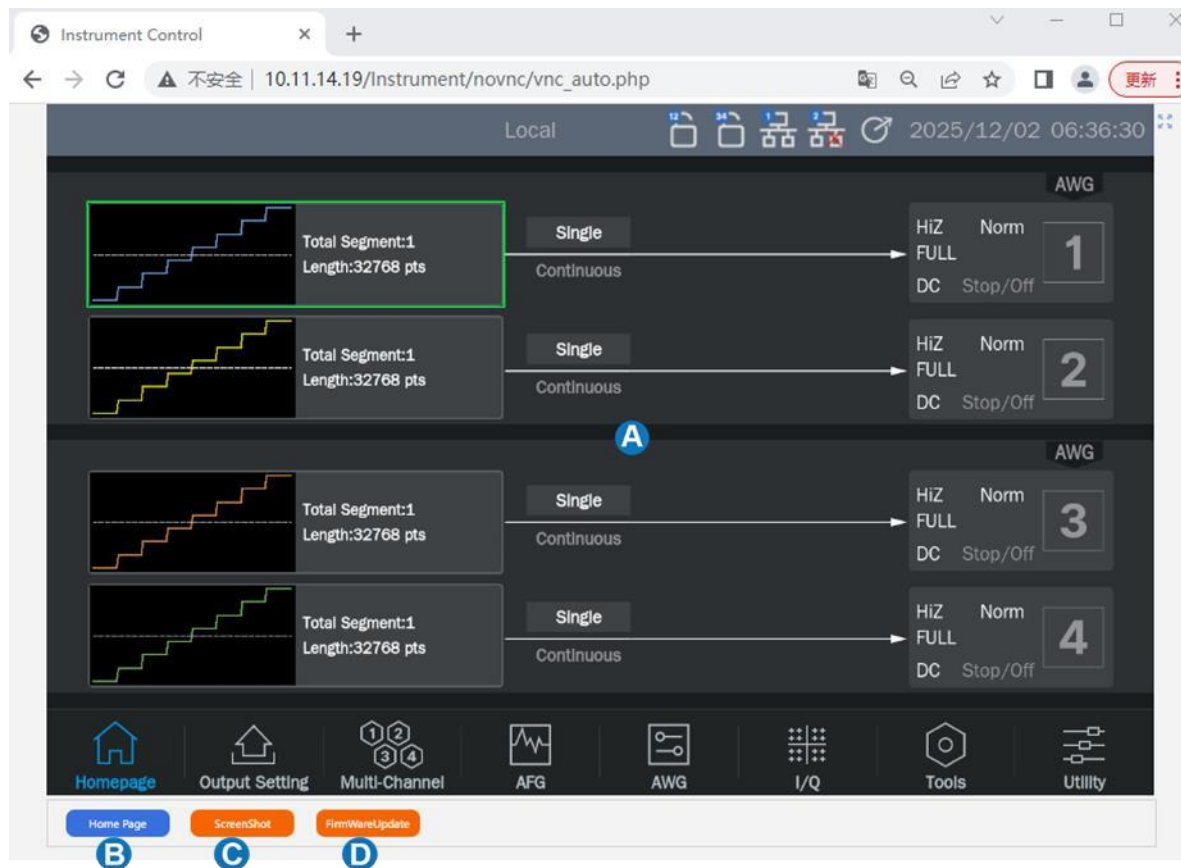

- A. Instrument interface display and control area, which displays a copy of the instrument display area. Using the mouse to operate in this area has the same effect as directly operating the instrument display area.
- B. Click to return to home page.
- C. Click to take the current screenshot.
- D. Click Upgrade Software Version.

7.2 Other Remote Control

This device also supports remote control of SCPI commands sent by the instrument through NI-VISA, Telnet or Socket connection. For details, please refer to the programming manual of this product.

8 Quick Start

8.1 Front Panel



- A. **Power Key** Used to turn the instrument on or off. When the power key is turned off, the instrument is in a power-off state.
- B. **USB Host** Used to connect USB storage devices or peripherals (mouse/keyboard)
- C. **Display Area** Displays the menu and parameter settings, system status and prompt information of the current function.
- D. **Number Key** Used to enter parameter values.
- E. **Knob** When setting parameters, turn the knob to increase (clockwise) or decrease the parameter value; When storing or reading files, turn the knob to select files.
- F. **Direction Key** Used to change the position of the cursor
- G. **Output Control** Used to turn off all channel outputs.
- H. **Manual Trigger Key** Used for key triggering when manually triggering A/B.
- I. **Mode/Auxiliary Function Keys** Function menu shortcut key, which can quickly switch IQ/AWG/AFG modes and quickly enter the MOD/SWEEP/BURST function menu under AFG. .
- J. **Auxiliary Function Key** Used to quickly enter the system setting interface.
- K. **Home Key** Quickly return to the main interface from any interface.
- L. **Touch Screen Key** Touch screen switch button, used to turn on or off the touch screen function.
- M. **Marker Output Interface** Two marker output interfaces per channel.
- N. **Channel Output Interface** For the output interface of each channel, "+" and "-" in DC mode are the P and N terminals of DC output respectively; In AC mode, "AC" output.

8.2 Rear Panel



- A. **OCXO** Optional, factory installed.
- B. **Dynamic Control** Dynamic control signal input interface
- C. **USB Device** Through this interface, a PC can be connected, and the signal generator can be controlled by the upper computer software EasyWaveX or user-defined programming.
- D. **LAN** Connect the instrument to the computer or the network where the computer is located for remote control.
- E. **USB Host** Used to connect USB storage devices or peripherals (mouse/keyboard)
- F. **DP** Used to connect an external display.
- G. **HDMI** Used to connect an external display.
- H. 232 Serial Port forbidden.
- I. DVI Serial Port forbidden.
- J. **AC Power Input** Power input port of the instrument
- K. **10MHz IN/10MHz Out** 10 MHz reference clock input/output (reserved).
- L. **Sample Clock IN/ Sample Clock Out** Sampling reference clock input/output.
- M. **Sync Clock Out** Synchronous reference clock output.
- N. **Mod In** External analog modulation signal input port.
- O. **Sync In/Out** Sync Out is used as the output interface for the host to output sync synchronization signals when multiple devices are synchronized; Sync In is an input interface for receiving synchronization signals from the slave machine when multiple devices are synchronized.
- P. **CH1/2/3/4 Trig Out** When internal trigger or manual trigger is used for SWEEP and BURST functions, trigger signals can be output from this interface; In AFG/MOD, synchronous signals with the same frequency as the channel output signals are output, corresponding to four channels respectively.
- Q. **Trig in 1/2** Digital modulation, SWEEP, BURST, AWG, IQ, multi-pulse, multi-tone, etc. use external trigger, and the external trigger signal is input from this interface, which corresponds to the external trigger A/B respectively.

9 Screen Display Area

The whole screen of the device is a touch screen, which can be operated by touch screen or mouse.

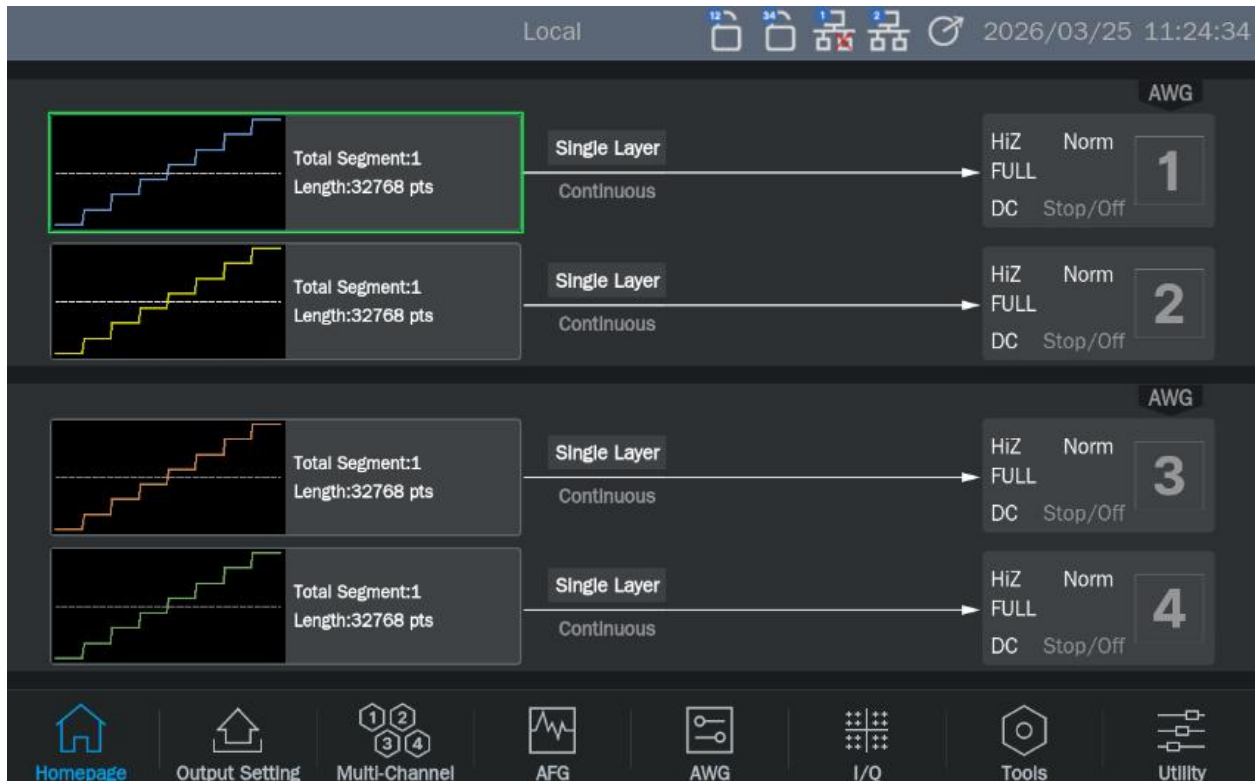

10 Front Panel Control

10.1 Mode Selection



Press / / of the front panel can switch between AWG, IQ and AFG respectively.

10.2 MOD/SWEEP/BURST Selection

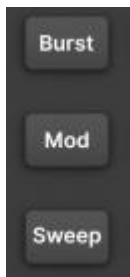



Press / / can quickly turn on/off the pulse train/modulation/frequency sweep function and jump to the corresponding parameter setting page. When the function is turned on, the corresponding key light is on.

10.3 Numeric Keyboard and Knob



Use the numeric keypad to directly input the values and orders of magnitude of the selected parameters. For example, set the frequency to 1 MHz, Press the key in turn and .



In addition to using the numeric keyboard to directly enter the parameter values, you can also use the knob to realize the continuous adjustment of the parameters. Press the knob on the selected parameter box, Press  and  Select the digits to be adjusted, Then turn the knob clockwise to increase the value, or counterclockwise to decrease the value.

11 AFG Basic Waveform

11.1 Standard Waveform

This section applies to sine wave, square wave, pulse, ramp and DC. Let's take sine wave as an example to explain some basic parameters of standard waveform.

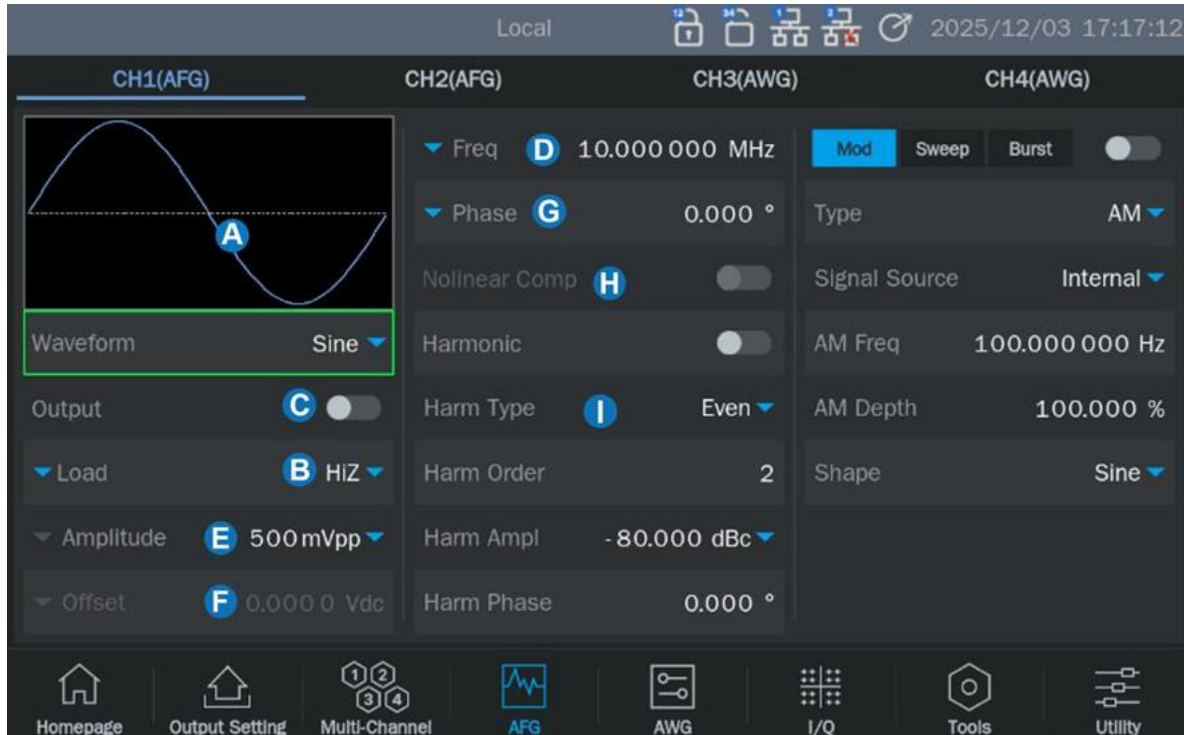

- A. Waveform preview
- B. Load parameter display
- C. Output status display
- D. Frequency/period parameter setting menu
- E. Amplitude/high level parameter setting menu
- F. Offset/low level parameter setting menu
- G. Phase/delay parameter setting menu
- H. Nonlinear compensation (only suitable for sine wave, mutually exclusive with harmonic function)
- I. Harmonic parameter setting menu (sine wave only)

Load

To understand the setting of the load, it is necessary to understand that the voltage V_o seen by the user is a variable related to the load R_L due to the impedance of the load and the internal resistance of the signal source (Figure 11-1).

$$V_o = V_s \cdot \frac{R_L}{R_L + R_s}$$

Where V_s is the output voltage of the signal source before the internal resistance, and R_s is the internal resistance of the signal source. Because the signal source can't automatically identify the size of R_L , the user needs to inform the signal source of the value by inputting the "load" value, and then the signal source can calculate the due V_s according to the R_L and V_o set by the user, so that the voltage value obtained by the user is consistent with the expected value under any load condition.

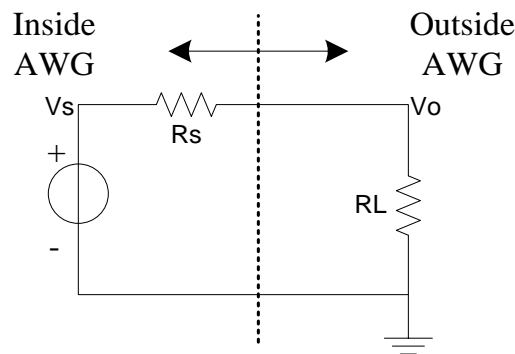

Figure 11-1

Waveform Parameter

The parameters that can be set for each standard wave are different, as shown in the table below:

Table 11-1 Specification of standard waveform parameters

Sine	
Frequency/period	Frequency/period of the signal. The unit of frequency is Hz, and the unit of period is S. The relationship between them is: frequency = 1/ period.
Amplitude/high level Offset/low level	The amplitude/offset of the signal is linked with the high level/low level. Amplitude value refers to the difference between the top value (high level, unit V) and the bottom value (low level, unit V) of the signal. The supported units include Vpp, Vrms and dBm (available when the load is ≠HiZ); Offset refers to the DC component superimposed on the signal waveform, unit V; The relationship between several parameters is: Amplitude (Vpp) = high level-low level Offset = (high level+low level) /2
Phase/delay	The phase/delay of the signal is meaningful only when the dual-channel

	phase mode = phase lock, which is used to set the phase relationship between two channels. The unit of phase is °, and the unit of delay is S. The relationship between them is: delay = -(period x phase/360°).
Square	
Frequency/period	Same as sine wave
Amplitude/high level Offset/low level	Same as sine wave
Phase/delay	Same as sine wave
duty	The ratio of positive pulse width to period of square wave, unit %
Pulse	
Frequency/period	Same as sine wave
Amplitude/high level Offset/low level	Same as sine wave
width/duty	Pulse width refers to the positive pulse width of the pulse, in s; Duty cycle refers to the ratio of pulse width to period in%. The relationship between them is: pulse width = period x duty ratio.
Rise /Fall	The rising edge refers to the rising time of 10%~90%, and the falling edge refers to the falling time of 90%~10%, and both units are s. The rising edge and the falling edge are independent of each other and can be set separately.
delay	Same as sine wave
Ramp	
Frequency/period	Same as sine wave
Amplitude/high level Offset/low level	Same as sine wave
Phase/delay	Same as sine wave
symmetry	The ratio of the rising period of triangular wave to the period, in%.
DC	
offset	Same as sine wave



Application example: Set the output sine wave of CH1 with the following parameters.:

Load = 50 Ω

frequency = 1 MHz

Amplitude = 0 dBm

offset = 0 V

phase = 180°

1. Select waveform

Click the waveform preview area and select "Sine" in the waveform selection menu that pops up:

2. Set load

Select "Load" with the cursor, and the load parameter setting will be displayed as 50 Ω .

3. Set waveform parameters

Set frequency: select the frequency setting menu and type 1 in the numeric keypad on the front panel, Then type MHz .

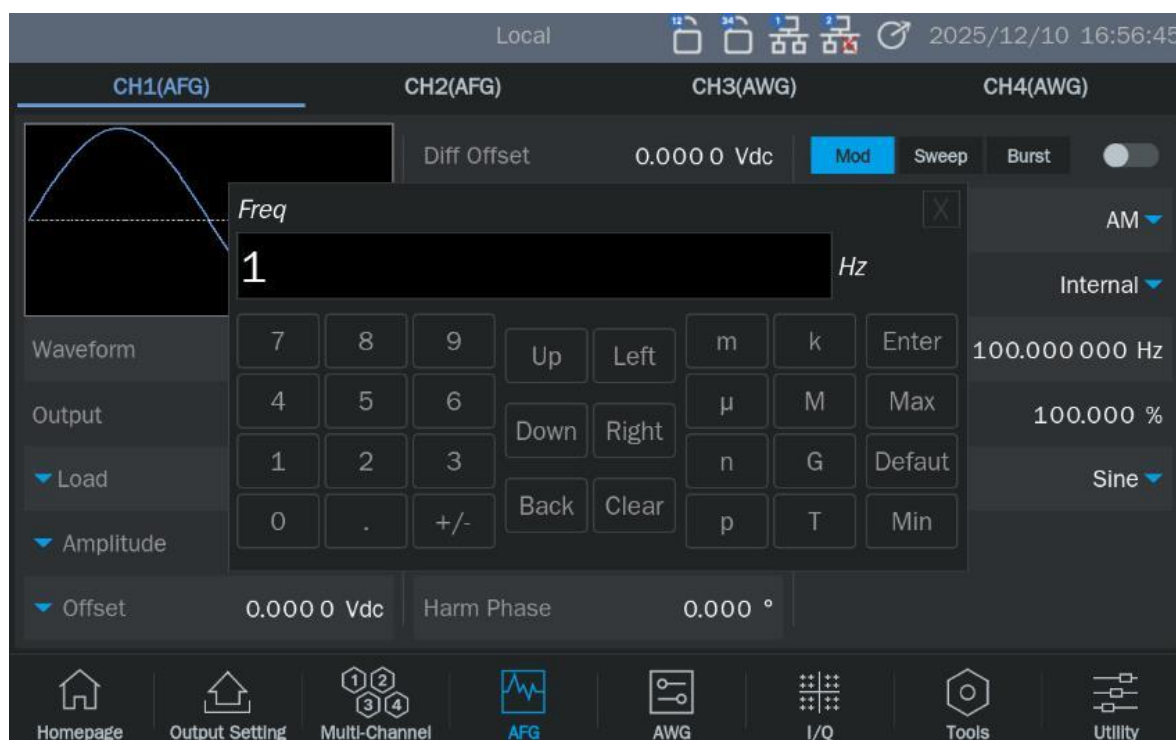

Set amplitude: select *Amplitude* , Click the inverted triangle of amplitude unit and select dBm , Type 0 in the numeric keypad on the front panel.

Set offset: select **Offset** , Type **0** in the numeric keypad on the front panel, and then select **Vdc** in the pop-up menu.

Set phase: select **phase** , Type **180** in the numeric keypad on the front panel, and then select **°** in the pop-up menu.

Open output: Select channel 1, open **Output** , The output indicator light of the corresponding channel is lit, and at the same time, the output switch is turned on to output signals.

By following the above steps, the expected sine wave can be output.

11.2 Harmonic

Harmonic is a sub-function of sine wave generation function, which can output harmonics with specified times, amplitude and phase, and is used to simulate sine waves with unsatisfactory linearity.

Under the sine wave parameter setting page, the harmonic parameter setting menu will appear.

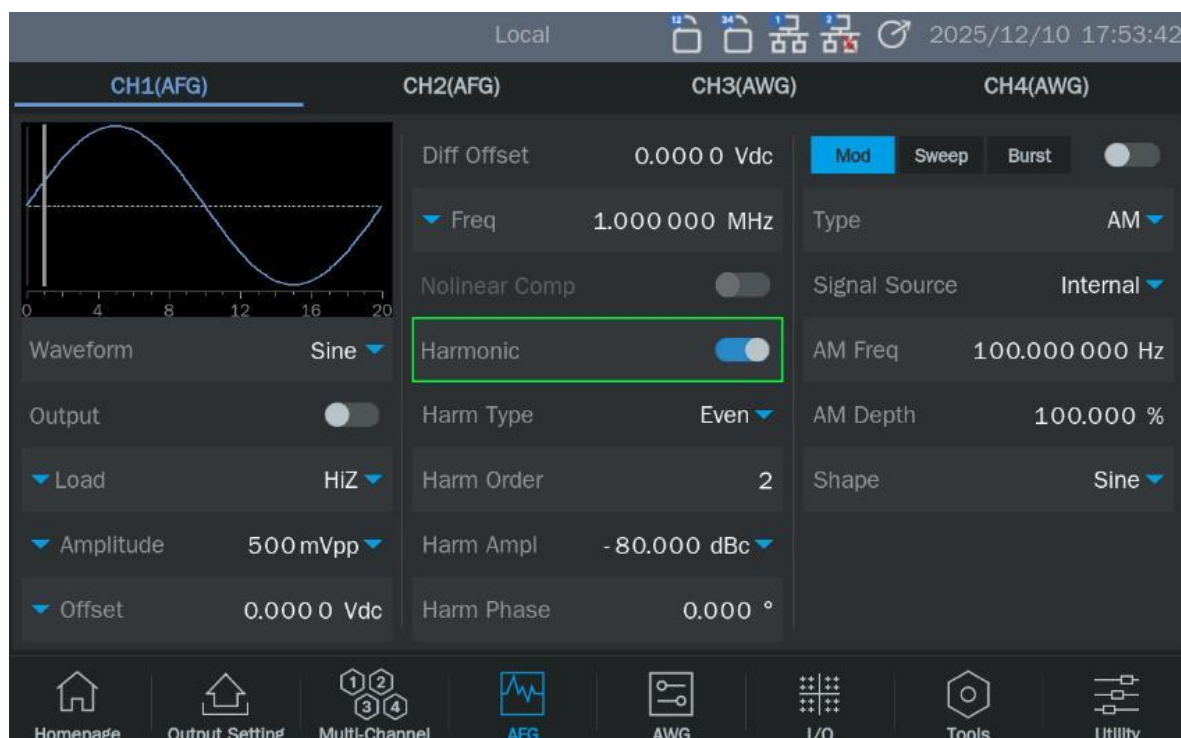

Set the harmonic type

Click the parameter value area of harmonic type in the "Type" parameter setting box, and then select the harmonic type in the parameter selection dialog box that pops up. If only odd harmonics are set,

select "odd harmonics"; If only even harmonics are set, select "even harmonics"; If both odd harmonics and even harmonics need to be set, select Custom.

Set the harmonic number

Click the "frequency" parameter setting menu, and then type it through the numeric keypad or set the required harmonic frequency through the knob. If type = odd harmonics, only odd values can be entered; If Type = Even Harmonic, only even values can be entered; If Type = User-defined, you can type any integer in the range of 2~ the maximum harmonic number.

Set harmonic amplitude

Click the "Harmonic Amplitude" setting menu, set the required amplitude through the numeric keypad or knob, and then select the unit as "Vpp" or "dBc". The unit "Vpp" is suitable for setting the absolute amplitude of harmonics, and the unit "dBc" is suitable for setting the relative amplitude of harmonics relative to the fundamental frequency signal.

Set harmonic phase

Click the "Phase" setting menu, and then type the value to be set through the knob or the numeric keypad. The unit of phase is "", and the adjustable range is 0 ~ 360°.

Turn on the harmonic function

After all harmonic parameters are set, the time domain waveform can be previewed through the waveform preview diagram, and the set harmonics and their approximate amplitudes can be browsed through the harmonic schematic diagram. After confirmation, turn on the output of the channel to output the harmonic waveform.



Application example: Set the output sine wave of CH1 and its harmonics, and the parameters are as follows:

Fundamental frequency = 10 MHz, fundamental amplitude = 0 dBm.

Second harmonic amplitude -30 dBc, phase 0°

Third harmonic amplitude -40 dBc, phase 0°

1. Refer to the application example in the previous section, and set the waveform, frequency and amplitude of the fundamental wave:
2. Set harmonics

You need to set the Type to All;

First, set the amplitude and phase of the second harmonic: select "Harm Order" as "2"; Select "dBc" as the unit of harmonic amplitude, and then set the value to "-30"; Set "Harm Phase" to "0", and the unit defaults to "°";

Then set the amplitude and phase of the third harmonic in the same way as the second harmonic.

By following the above steps, the expected sine wave and harmonics can be output. The harmonic page after setting is as follows:

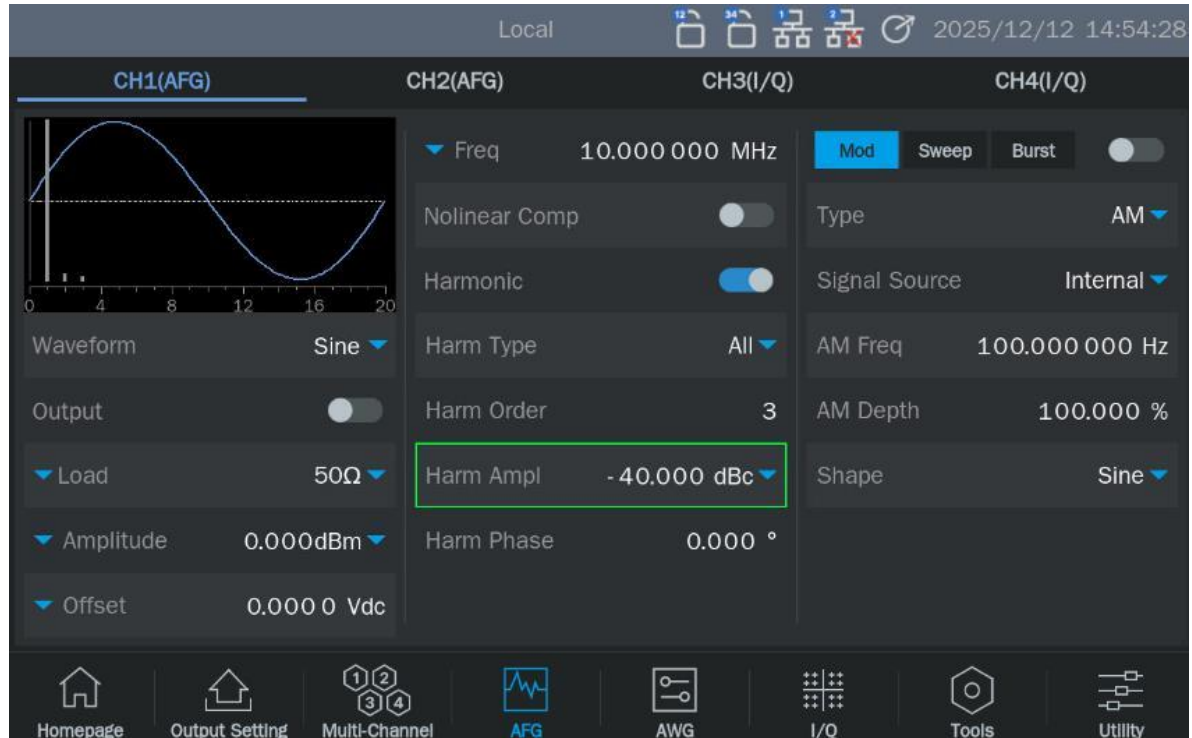

Note: Nonlinear compensation and harmonic function are mutually exclusive.

11.3 Noise

The noise can provide Gaussian noise with settable bandwidth.

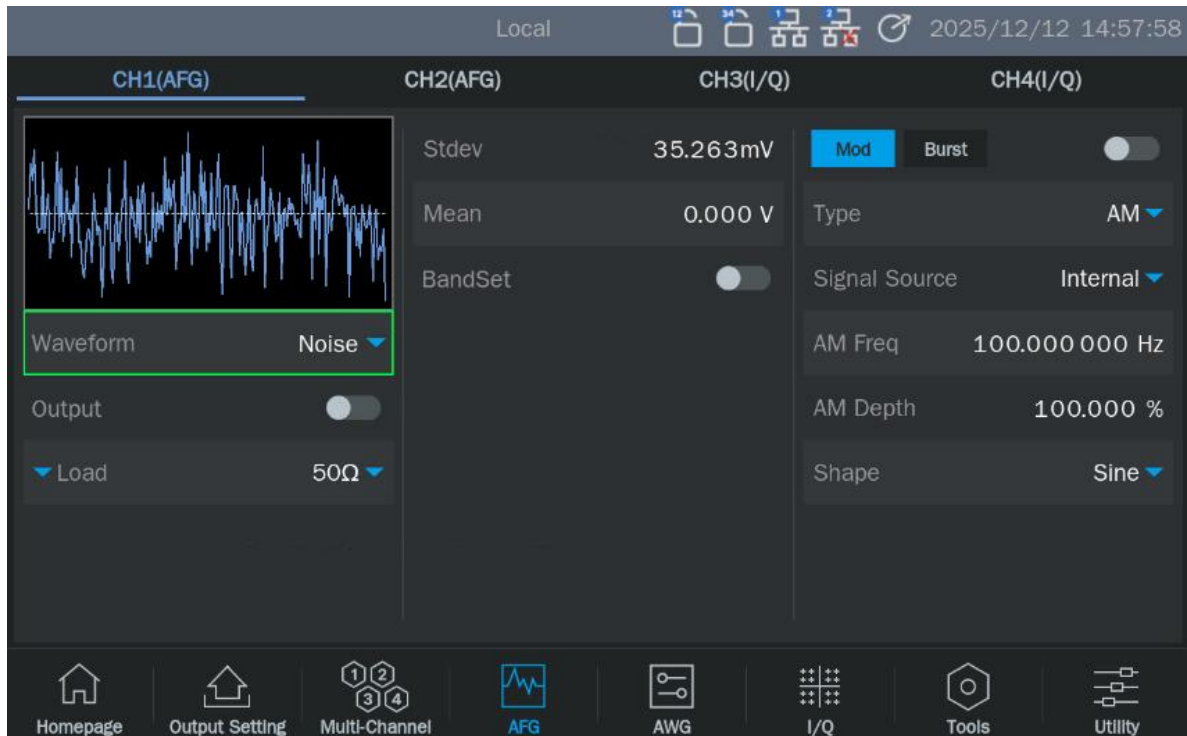

Set waveform parameters

The waveform parameters of noise include "standard deviation" and "mean value". Because noise obeys Gaussian distribution (normal distribution), its distribution characteristics can be characterized by mean value (m) and standard deviation (σ). Its setting method refers to the waveform parameter setting of sine wave.

Table 11-2 Description of noise waveform parameters

Noise	
standard deviation	Standard deviation of noise sequence
mean value	Average value of noise sequence (mathematical expectation)

Set bandwidth

To set the bandwidth of noise, first click the switch area in the bandwidth switch setting box to open the bandwidth setting, and then type the value and unit to be set.



Application example: Set CH1 to output the noise of the following parameters:

Standard deviation $\sigma = 40$ mVrms

Mean value $E = 0$ V

Bandwidth = 200 MHz

The load is "Hiz".

1. Switch to CH1;

2. Set the waveform to "Noise";
3. Set the "load" to "Hiz";
4. Set the standard deviation to 40 mV ;
5. Set the mean value to 0 v.;
6. Open "Bandwidth Settings" and set the bandwidth to 200 MHz in the "Bandwidth" parameter setting box that appears below.;
7. Open output.

By following the above steps, the expected noise can be output. The parameter page after setting is as follows:

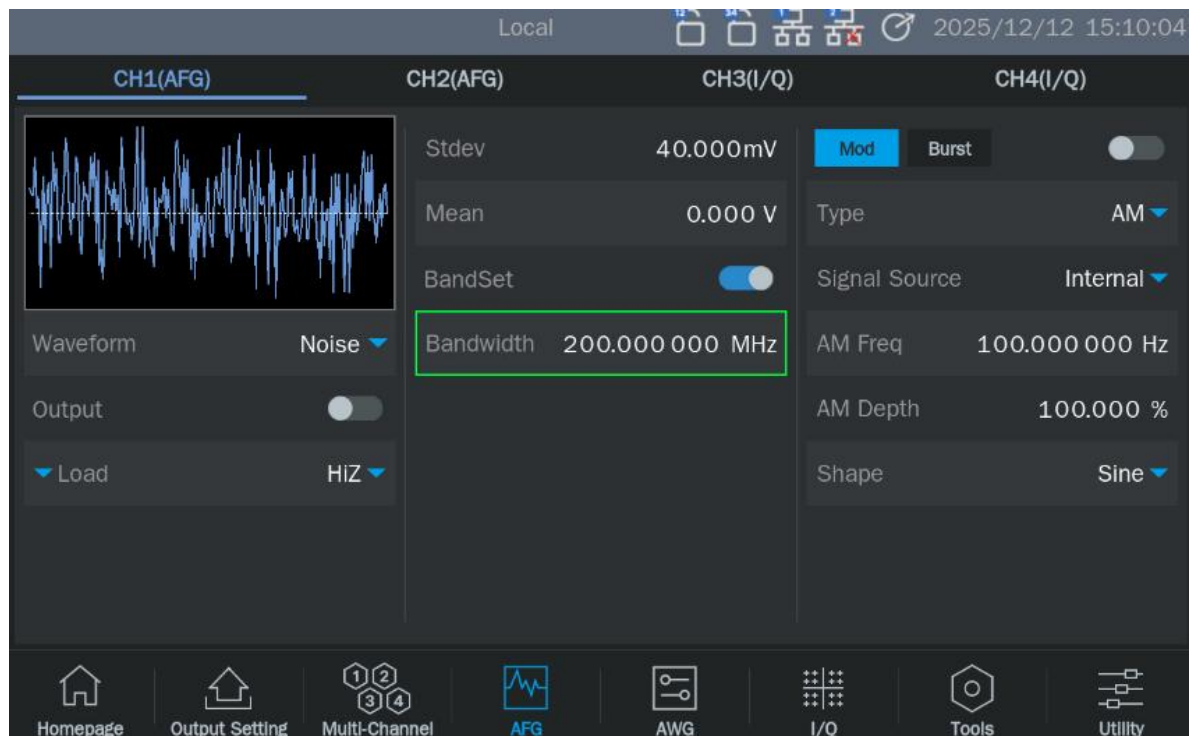

11.4 PRBS

The PRBS generation function can generate the highest bit rate of 1.25 Gbps, along the settable pseudo-random sequence.

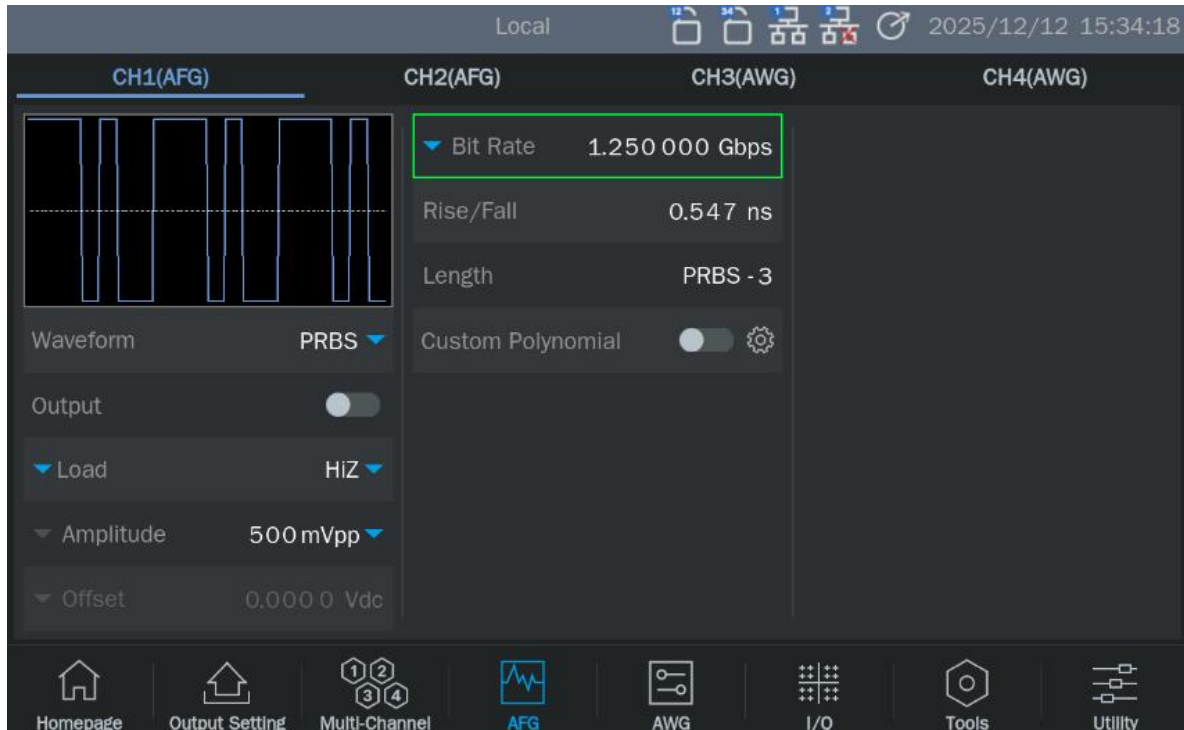

Setting parameters

The parameters of PRBS are shown in the table below. Its setting method refers to the waveform parameter setting of sine wave.

Table 11-3 Description of prbs parameters

PRBS	
Bit rate/period	Bit rate/symbol period of PRBS sequence, with bit rate in bps and period (UI) in s. The relationship between them is: Bit rate = 1/ period
Amplitude/high level Offset/low level	Same as sine wave
Code length	PRBS-3 ~ 32 can be set, corresponding to the length of $(2^3-1) \sim (2^{32}-1)$
Edge	Refers to the rising time of 10%~90% and the falling time of 90%~10%, and the unit is s. The rising edge and falling edge are set at the same time.

The polynomial and seed corresponding to the default optional code length are shown in Table 11-4

Table 11-4 Primitive polynomials of prbs-3 to prbs-32

prbs	polynomials	seed	length	standard
prbs -3	x^3+x^1+1	0x0000_0001	2^3-1	Longest sequence
prbs -4	x^4+x^1+1	0x0000_0001	2^4-1	Longest sequence
prbs -5	x^5+x^2+1	0x0000_0001	2^5-1	Longest sequence
prbs -6	x^6+x^1+1	0x0000_0001	2^6-1	Longest sequence
prbs -7	x^7+x^6+1	0x0000_0001	2^7-1	Longest sequence
prbs -8	$x^8+x^4+x^3+x^2+1$	0x0000_0001	2^8-1	Longest sequence
prbs -9	x^9+x^5+1	0x0000_01ff	2^9-1	ITU-T O.150
prbs -10	$x^{10}+x^3+1$	0x0000_0001	$2^{10}-1$	Longest sequence
prbs -11	$x^{11}+x^9+1$	0x0000_0001	$2^{11}-1$	ITU-T O.150
prbs -12	$x^{12}+x^6+x^4+x^1+1$	0x0000_0001	$2^{12}-1$	Longest sequence
prbs -13	$x^{13}+x^4+x^3+x^1+1$	0x0000_0001	$2^{13}-1$	Longest sequence
prbs -14	$x^{14}+x^{10}+x^6+x^1+1$	0x0000_0001	$2^{14}-1$	Longest sequence
prbs -15	$x^{15}+x^{14}+1$	0x0000_0001	$2^{15}-1$	ITU-T O.150
prbs -16	$x^{16}+x^{12}+x^3+x^1+1$	0x0000_0001	$2^{16}-1$	Longest sequence
prbs -17	$x^{17}+x^3+1$	0x0000_0001	$2^{17}-1$	Longest sequence
prbs -18	$x^{18}+x^7+1$	0x0000_0001	$2^{18}-1$	Longest sequence
prbs -19	$x^{19}+x^5+x^2+x^1+1$	0x0000_0001	$2^{19}-1$	Longest sequence
prbs -20	$x^{20}+x^3+1$	0x0000_0001	$2^{20}-1$	ITU-T O.150
prbs -21	$x^{21}+x^2+1$	0x0000_0001	$2^{21}-1$	Longest sequence
prbs -22	$x^{22}+x^1+1$	0x0000_0001	$2^{22}-1$	Longest sequence
prbs -23	$x^{23}+x^{18}+1$	0x0000_0001	$2^{23}-1$	ITU-T O.150
prbs -24	$x^{24}+x^7+x^2+x^1+1$	0x0000_0001	$2^{24}-1$	Longest sequence
prbs -25	$x^{25}+x^3+1$	0x0000_0001	$2^{25}-1$	Longest sequence
prbs -26	$x^{26}+x^8+x^7+x^1+1$	0x0000_0001	$2^{26}-1$	Longest sequence
prbs -27	$x^{27}+x^8+x^7+x^1+1$	0x0000_0001	$2^{27}-1$	Longest sequence
prbs -28	$x^{28}+x^3+1$	0x0000_0001	$2^{28}-1$	Longest sequence
prbs -29	$x^{29}+x^{27}+1$	0x0000_0001	$2^{29}-1$	ITU-T O.150
prbs -30	$x^{30}+x^{16}+x^{15}+x^1+1$	0x0000_0001	$2^{30}-1$	Longest sequence
prbs -31	$x^{31}+x^{28}+1$	0x0000_0001	$2^{31}-1$	ITU-T O.150
prbs -32	$x^{32}+x^{28}+x^{27}+x^1+1$	0x0000_0001	$2^{32}-1$	Longest sequence

Custom polynomial

The generation of PRBS depends on specific polynomials, which define the working mode of linear feedback shift register (LFSR). The commonly used default polynomials of PRBS are:

PRBS7 ($x^7 + x^6 + 1$): polynomial is $x^7 + x^6 + 1$, The corresponding LFSR has 7 bits, and the feedback comes from the 7th and 6th bits.

PRBS15 ($x^{15} + x^{14} + 1$): polynomial is $x^{15} + x^{14} + 1$, The corresponding LFSR has 15 bits, and the feedback comes from the 15th and 14th bits.

PRBS23 ($x^{23} + x^{18} + 1$): polynomial is $x^{23} + x^{18} + 1$, The corresponding LFSR has 23 bits, and the feedback comes from the 23th and 18th bits.

PRBS31 ($x^{31} + x^{28} + 1$): polynomial is $x^{31} + x^{28} + 1$, The corresponding LFSR has 31 bits, and the feedback comes from the 31th and 28th bits.

Taking PRBS7 as an example, you can input the polynomial $X^7 + X^6 + 1$ through the keyboard to customize the polynomial output:

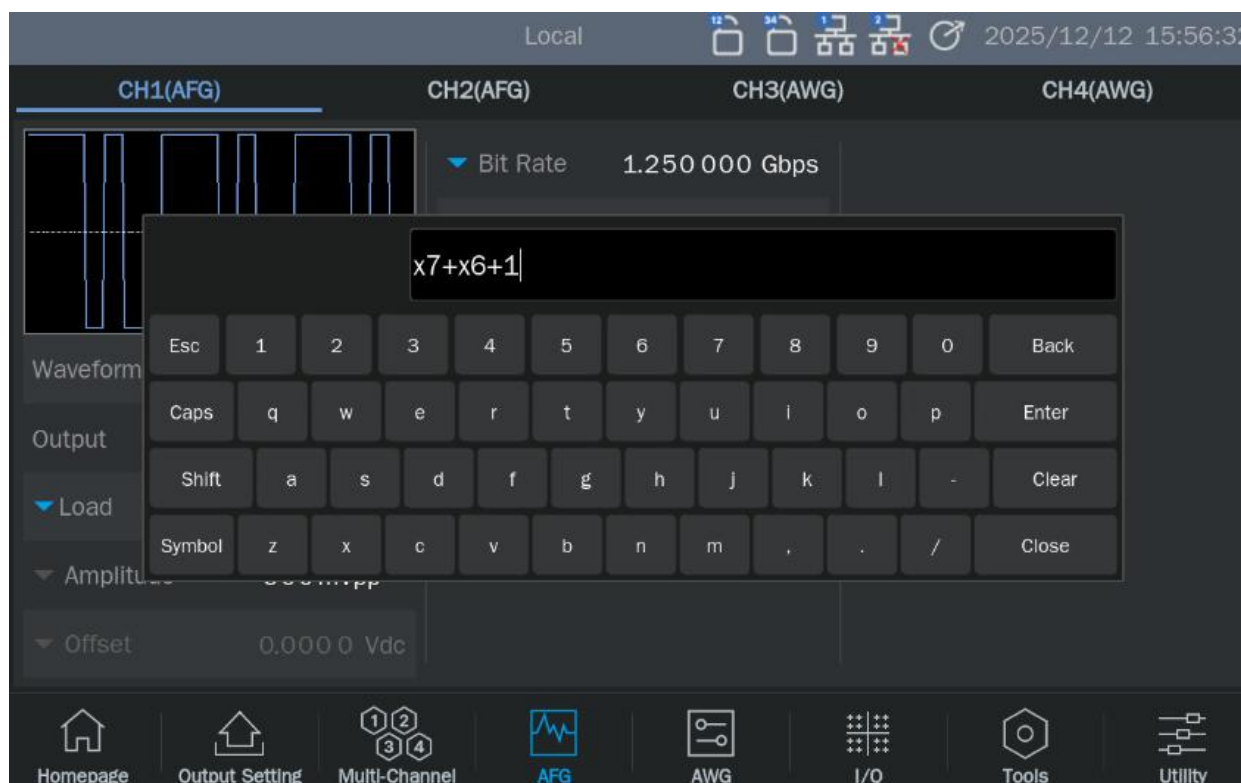

11.5 AFG-Arb

11.5.1 Arb

In AFG mode, the signal generator outputs the specified arbitrary wave in the way of traditional DDS. At this time, the basic waveform parameter setting is the same as sine wave. Please refer to the section "Standard Waveform".

11.5.2 Data Source

Click the data source parameter setting menu to enter the data source selection interface. Data sources include built-in waveform, from file and EasywaveX.

Built-in

Built-in waveform is a preset waveform in the signal generator, which is divided into several types, such as common use, mathematics, engineering, window function, trigonometric function, square wave, medical electronics, modulation, filter and demonstration, and there are various waveforms to choose from under each type.

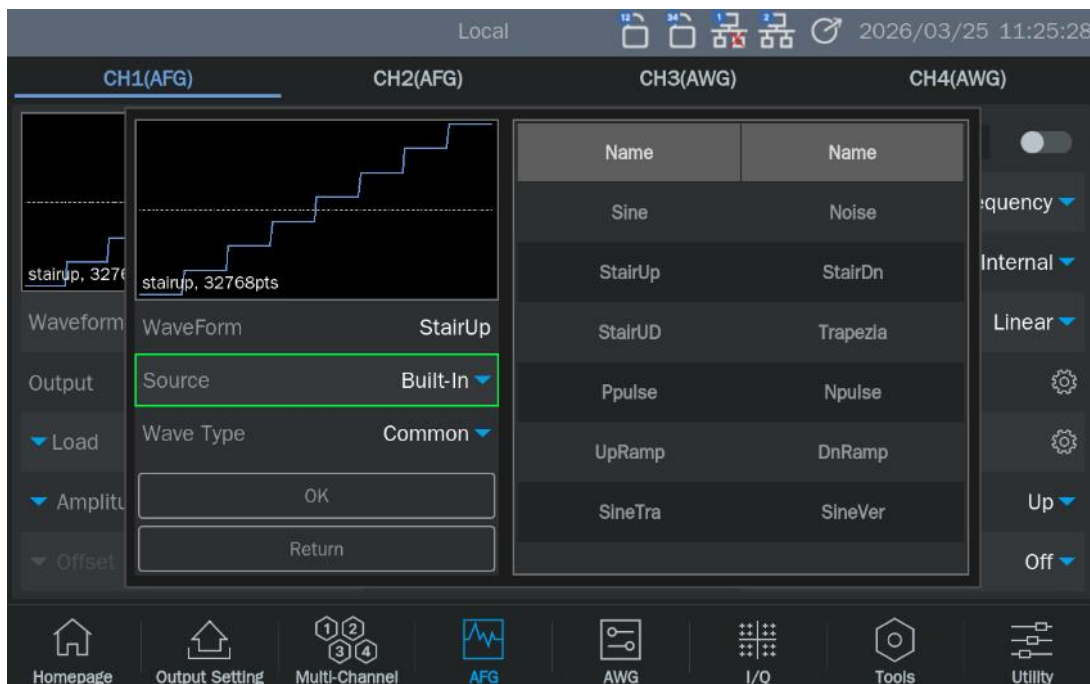

From File

The stored waveform is a waveform file saved by the user in a local directory, an external U disk, or a waveform file sent by the user to the device and saved locally under the upper computer software (EasyWaveX). When the data source is selected as "From File", the file manager window will be

automatically called. Select the waveform file to be called in this window, and then click "Recall".

For the operation method of the file management window, please refer to the chapter "Save And Recall".

EasyWaveX

EasyWaveX, an arbitrary wave editing software, provides 12 standard waveforms such as Sine, Square, Ramp, Pulse, Noise and DC, which can meet the most basic requirements. At the same time, it also provides users with manual drawing, straight line drawing (including horizontal straight line, vertical straight line and two-point straight line), coordinate drawing (coordinates can be input by mouse or table, and there are two ways of connecting and smoothing) and equation drawing, which makes it easy to create complex waveforms.

For the use of EasyWaveX, please refer to the help of the software itself.



Application example: Using the software EasyWaveX to generate waveforms of digital clock and data simulating the following time series relationship, and download them to the output of CH1 and CH2 of any waveform generator, and the rate can be adjusted at will.

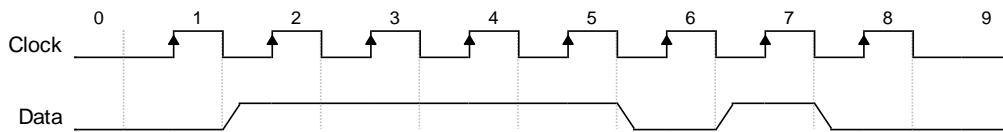

1. Open the embedded EasyWaveX and create a new 60-point arbitrary wave.
2. In the Properties area of the toolbar, select Waveform Properties , and enter the level of each point in the "Point Table" according to the jumping rules of clock "0", "0", "0", "1", "1" and "1", as shown below:

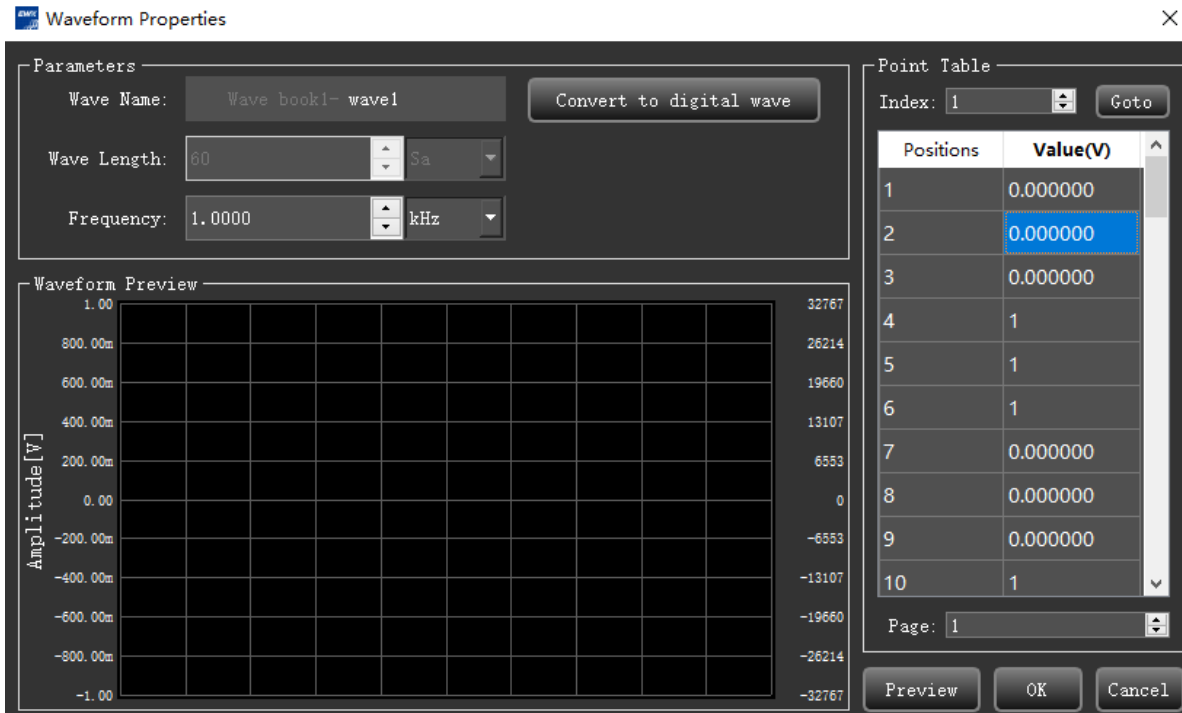

- After the input, view the waveform in the waveform preview window of the main program. In the Properties area of the toolbar, select View Properties  and change the Interpolation to “o-order hold”:
- Perform *communication* > *Send waveform to AWG* , select the device to perform waveform output in the pop-up dialog box, click Connect, and select the download target channel as CH1:

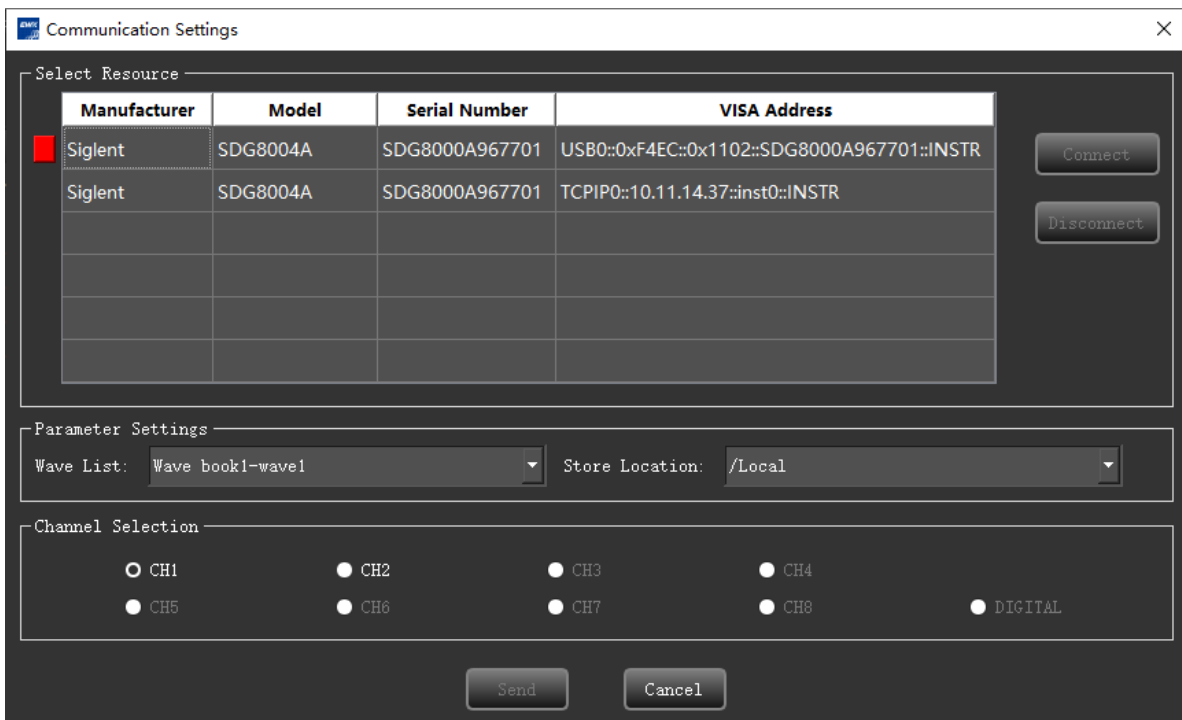

5. Use the same method to generate a data file and download it to CH2 of the device:
6. Set the amplitude and rate of clock and data output on the device as required. The clock and data signals finally output by the device are as follows:

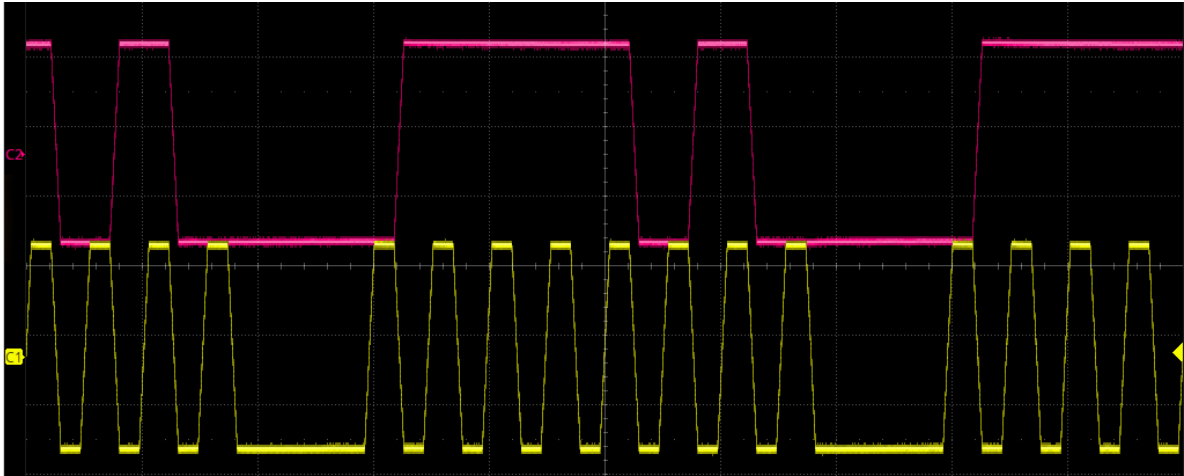

You can save the waveform generated by EasyWaveX as a csv file for further editing, import it into EasyWaveX after editing, and send it to the device through EasyWaveX. You can also save the csv file to a USB flash drive, and the device can be called directly from the USB flash drive.

12 AWG

In AWG mode, the signal generator uses TrueArb technology (Figure 12-1) to output the specified waveform sequence point by point at the specified sampling rate. TrueArb overcomes the serious defect that traditional DDS technology may increase jitter and distortion when generating arbitrary waves, while retaining its advantages of low cost, simplicity and flexibility.

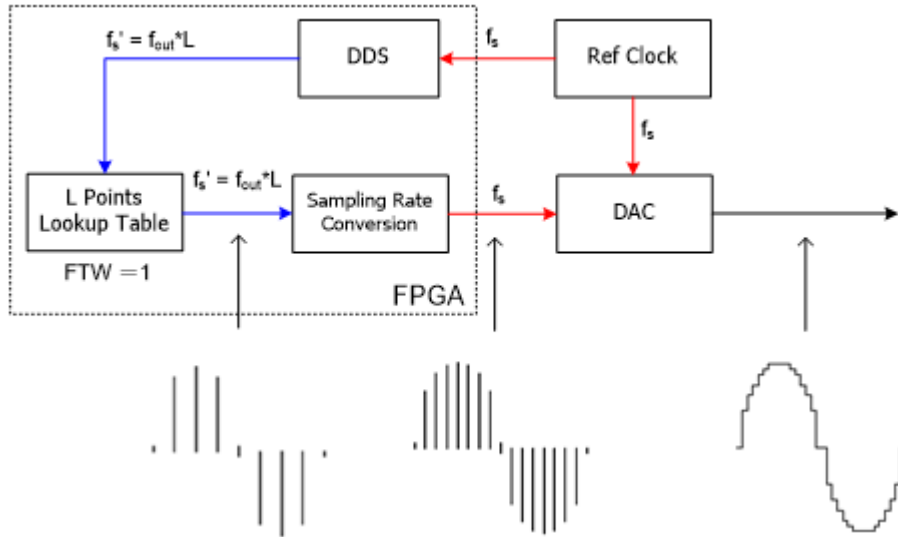
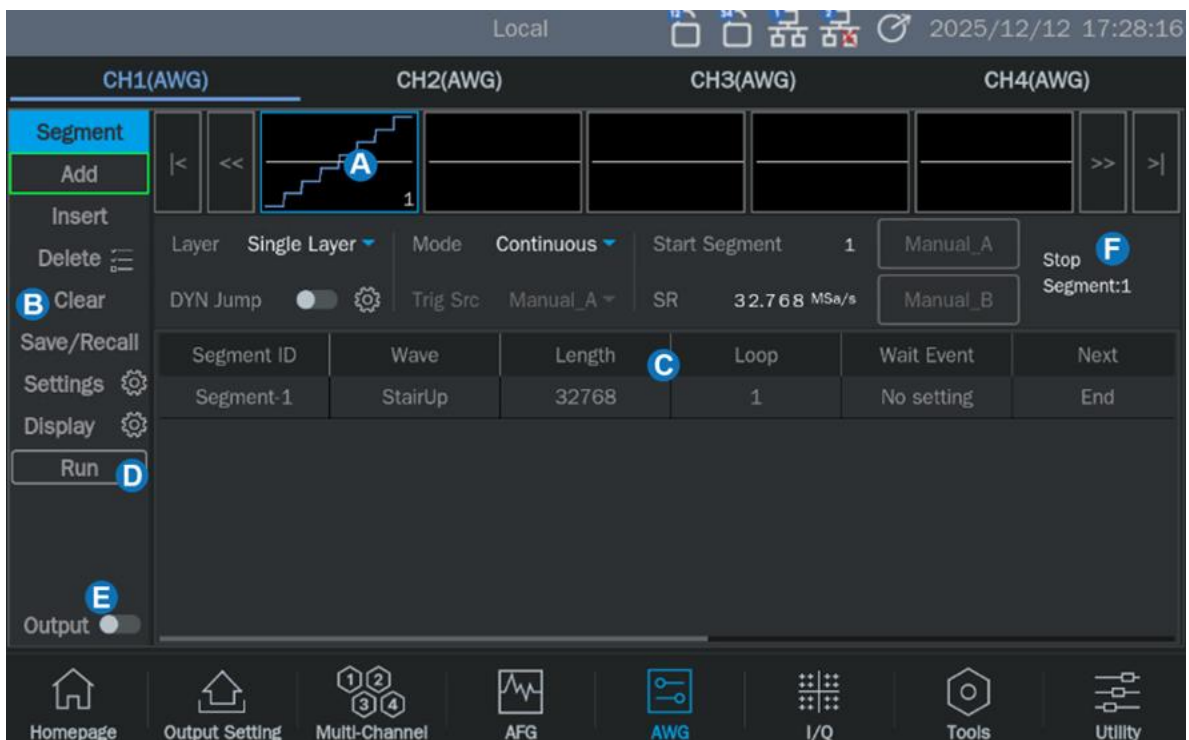

Figure 12-1 Principle block diagram of TrueArb technology



- A. Waveform preview
- B. Segment setting

- C. Segment parameter setting
- D. Running switch
- E. Channel output switch
- F. Running status and current output segment display

12.1 Add/Insert/Delete/Clear

Add, Insert, Delete and Empty Settings Multi-segment in the left menu bar.

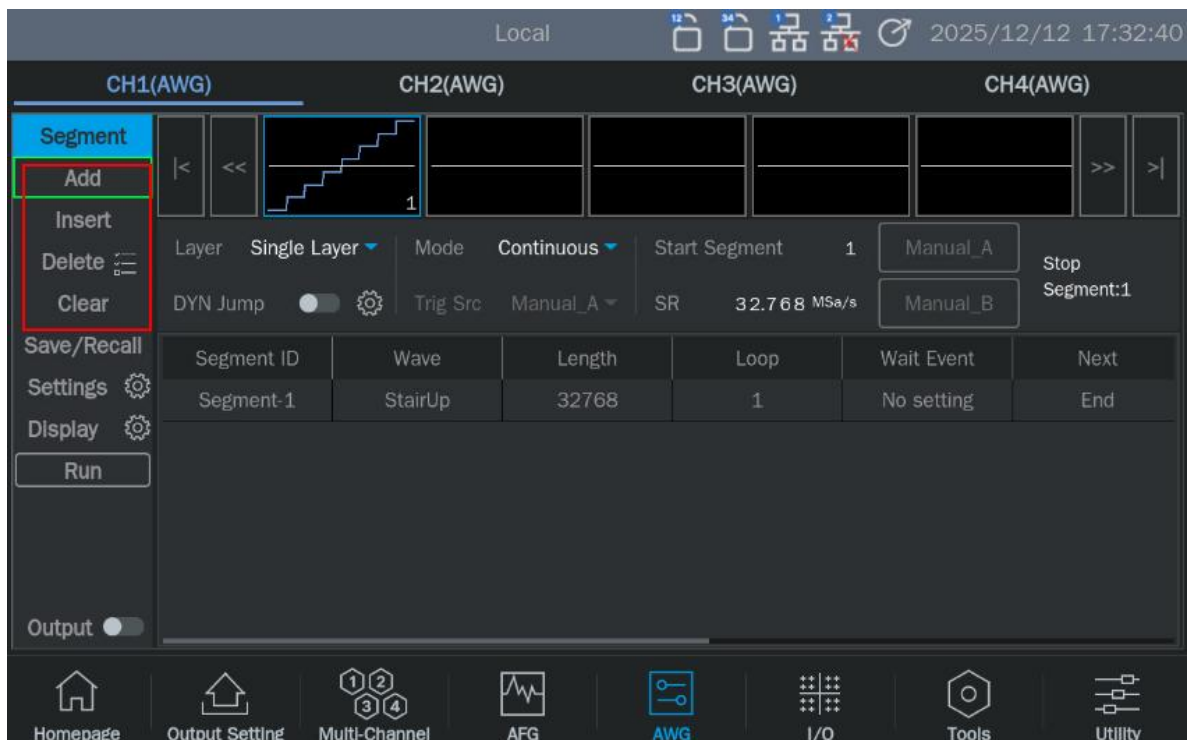

Table 12-1 Segment setting

Segment setting	Description
Add	Add a new one after the last paragraph of Scenario or Sequence or Segment.
Insert	Insert a before the currently selected last Scenario or Sequence or Segment.
Delete	Delete the currently selected Scenario, Sequence or Segment. Multiple segments can be deleted at the same time.
Clear	Empty all the current Scenarios or Sequences or Segments, leaving only a default scenario or sequence or segment.

Note: Scenario and Sequence are only available when the layer are "Multilayer". so you need to purchase the "Multilayer" option to enable them.

12.2 Save/Recall

The save/load function of AWG can save the currently configured waveform parameters and waveform data for loading next time. Only awgx file types can be saved in single-layer and single-wave levels, and three file types, awgx, scen and seq, are supported in multi-layer. See the table below for details.

Table 12-2 Save/load file type

File Type	Description
AWG	Saves/loads the AWG of the current layer, only saves the configuration, and does not save/load the waveform data. When loading, the level will be set according to the level where the file is saved. For example, loading a multi-layer awgx file under a single layer will switch to multi-layer; The saved waveform saved in the file, if not in the Local path of the machine, will set the default built-in StairUp waveform. The file suffix is .awgx.
AWG(with wavefile)	Save/load the AWG of the current level, and save/load the configuration and waveform data. When loading, the level will be set according to the level where the file is saved. For example, loading a multi-layer awgx file under a single layer will switch to multi-layer. The file suffix is .awgx.
Current scenario	Save/load current scenario in multi-tier, only save configuration, not save/load waveform data. Load the saved waveform saved by the file, and set the default built-in StairUp waveform if there is no waveform in the Local path of the machine; The loaded file will be added to the end as a new scenario. The file suffix is .scen.
Current scenario (with wavefile)	Save/load the current scenario in multi-tier, and save/load the configuration and waveform data. The loaded file will be added to the end as a new scenario. The file suffix is .scen.
Current sequence	Save/load the current sequence in multi-layer, only save the configuration, not save/load the waveform data. Load the saved waveform saved by the file, and set the default built-in StairUp waveform if there is no waveform in the Local path of the machine; The loaded file will be added to the end of the current scenario as a new sequence. The file suffix is .seq.
Current sequence (with wavefile)	Save/load current sequence, configuration and waveform data in multi-tier. The loaded file will be added to the end of the current scenario as a new sequence. The file suffix is .seq.

12.3 Setting

The waveform parameter setting method of AWG refers to the waveform parameter setting of sine wave.

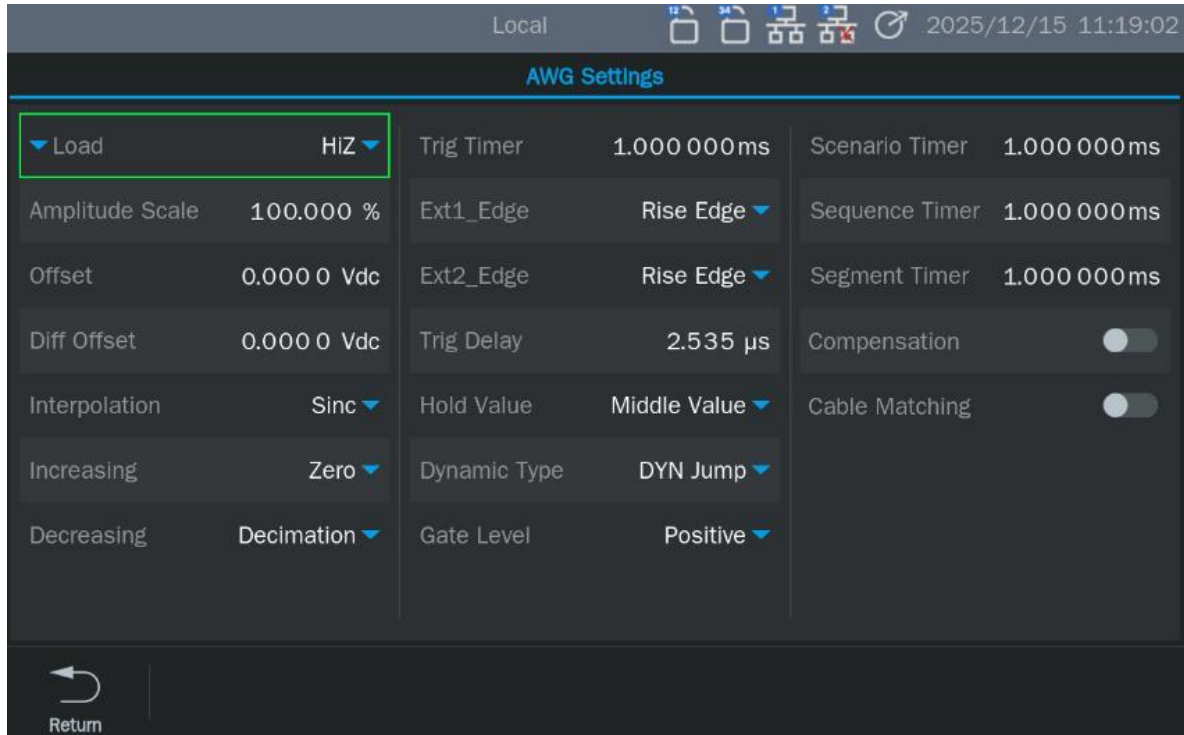

Table 12-3 AWG setting parameter description

Setting	Description
Load	The output load of AWG can be selected as 50 Ω, HiZ and custom.
Amplitude Scale	Set the amplitude ratio, and the Segment amplitude can be output in% according to the set ratio.
Offset	The offset is the DC component superimposed on the overall waveform of AWG, and the unit is V.
Diff Offset	Only supported in DC-AMP output mode. Set the P/N terminal bias under differential output.
Interpolation	For interpolation types of waveforms, see Table 12-4
Increasing	Waveform interpolation method, see Table 12-5
Decreasing	Waveform decreasing method, see Table 12-6
Trig Timer	This parameter is used to set the interval of AWG wave output, which is only valid in triggered mode.

Ext_Edge	Set when triggered externally, including rising edge, falling edge and upper and lower edge.
Trig Delay	This parameter is used to set the delay time of trigger signal, and the minimum value of trigger delay represents the minimum delay that can be achieved on hardware.
Hold Value	Middle Value: The output level after the output of AWG waveform refers to the offset of the whole AWG, not the middle value of each segment.
	Start Value: The level is the starting value of the output waveform.
	End Value: The end value of the output waveform.
	Custom Value: The actual output level is the set level value plus the overall offset value of awg. The settable range is the maximum high level and minimum low level of all awg waveforms, that is, [minimum low level to maximum high level].
Dynamic Type	Use dynamic jump to set dynamic jump types, including dynamic control and dynamic jump.
Gate Level	Effective when the mode is set to "Gate External", which is used to set the effective level of external signals.
Scenario Timer	When the layer is multi-layer and the mode is advanced, the scenario output timing time can be set.
Sequence Timer	When the layer is multi-layer and the mode is advanced, the sequence output timing time can be set.
Segment Timer	Segment outputs the timing time, which is effective when the mode is advanced.
Compensation	A broadband compensation switch for compensating the amplitude and phase of a broadband signal. The output time of open compensation loading waveform will be longer.
Cable Matching	Cable matching can generate a transfer function according to the S parameter of the cable at the external receiving end and the reflection coefficient parameter of the receiving end, and compensate the loss brought by the receiving end when outputting, so that the signal received by the receiving end is closer to the set value.

Table 12-4 Interpolation types supported by AWG

Interpolation	Description
0-order hold	0-order hold, which can be set within the sampling rate of 1.25 GSa/s.
Linear	Linear interpolation
Sinc	Sinx/x interpolation

Sinc13	Sinx/x interpolation combined with low-pass filtering, bandwidth = 0.13x sampling rate.
Sinc27	Sinx/x interpolation combined with low-pass filtering, bandwidth = 0.27x sampling rate.

Table 12-5 Increasing mode supported by AWG

Increasing	Description
Interpolation	When the set waveform length is greater than the original length of the waveform file, linear interpolation is performed between points.
Zero	When the set waveform length is greater than the original length of the waveform file, zero is added after the waveform point.
Hold Last	When the set waveform length is greater than the original length of the waveform file, repeat the last point after the waveform point.
Duplication	When the set waveform length is greater than the original length of the waveform file, repeat the waveform sequence from the first point of the waveform after the waveform point until it is consistent with the set number of points in the segment.

Table 12-6 Decreasing mode supported by AWG

Decreasing	Description
Decimation	When the set waveform length is less than the original length of the waveform file, the set number of points is obtained by proportional extraction.
Cut Tail	When the set waveform length is less than the original length of the waveform file, the waveform head is reserved according to the set number of points, and the later points are truncated.
Cut Head	When the set waveform length is less than the original length of the waveform file, the number of points in the back part of the waveform is reserved according to the set number of points, and the number of points in the front part is truncated.

12.4 Display

The displayable item setting can display the parameters to be displayed in the segment parameters, and the user can set the segment parameters to be displayed by himself.

Scenario Display

Table 12-7 Scenario display

Display	Description
Loop	The number of times the scenario is output in a cycle, which is displayed by default.
Wait Event	Set the trigger condition of scenario, which is effective when the running mode is advanced and displayed by default.
Next	Used to set the next scenario to be output after the current scenario is played, which is displayed by default.
Start ID	Used to set the sequence of the first output in the current scenario.
Playback	Set the playback conditions of scenario.
Out Event	Jump-out condition set when playback condition is advanced

Sequence Display

Table 12-8 Sequence display

Display	Description
Loop	The number of times the sequence is output in a cycle, which is displayed by default.
Wait Event	Set the trigger condition of sequence, which is effective when the running mode is advanced and displayed by default.
Next	Used to set the next sequence to be output after the current sequence is played, which is displayed by default.
Start ID	Used to set the segment of the first output in the current sequence.
Playback	Set the playback conditions of sequence.
Out Event	Jump-out condition set when playback condition is advanced

Segment Display

Table 12-9 Segment display

Display	Description
Wave	Displays the waveform name. Click this item to select the waveform data source, which is displayed by default.
Length	The output length of segment waveform, which can be modified by users according to their requirements, is displayed by default.

Loop	The number of times the segment is output in a cycle, which is displayed by default.
Wait Event	Set the trigger condition of segment, which is effective when the running mode is advanced and displayed by default.
Next	Used to set the next segment to be output after the current segment is played, which is displayed by default.
Playback	Set the playback conditions of segment.
Out Event	Jump-out condition set when playback condition is advanced
Amplitude	The amplitude of Segment waveform, which is displayed by default.
Offset	The offset of Segment waveform, which is displayed by default.
High Level	The high level of Segment waveform, which is not displayed by default.
Low Level	The low level of Segment waveform, which is not displayed by default.

Note: Scenario and Sequence are only available when the layer are "Multilayer". so you need to purchase the " Multilayer " option to enable them.

12.5 Layer

Segment

A segment is the smallest segment of a sequence, each segment is a waveform, and a single segment can be played continuously, and the number of repetitions and trigger conditions can be specified. The Segment waveform needs to be greater than or equal to the minimum waveform length of 1024, and it must be an integer multiple of 16 when it is less than 2048 points.

Sequence

Multiple segments can form a sequence. Similarly, each sequence can be played continuously, and the number of repetitions and trigger conditions can be specified.

Scenario

Multiple sequences make up scenario. Similarly, each scenario can be played continuously, and the number of repetitions and trigger conditions can be specified.

There are three levels of AWG: single wave, single layer and multi-layer. Multilayer contains at least one Scenario, one Sequence and one Segment. At least one Segment of a single layer. The total

number of supported segments is limited by the total number of waveform points. The number of waveform points is 2 Gpts as standard in the factory, and the maximum number of supported segments is 4Gpts (you need to purchase an option to enable it).

Table 12-10 Layer

Layer	Description
Single Layer	Only one level of Segment is supported.
Multilayer	Support Scenario, Sequence and Segment.
Single Wave	Only a single waveform can be output.

Note: Scenario and Sequence are only available when the layers are set to "Multilayer". so you need to purchase the " Multilayer " option to enable them.

12.6 Sampling Rate

Sampling rate of the signal. The unit of sampling rate is Sa/s, which refers to the rate at which waveform points are output; Sampling rate = frequency * waveform points

12.7 Mode

Table 12-11 Mode

Mode	Description
Continuous	The internal signal is automatically triggered, and all waveforms are continuously output in the set order.
Triggered	Triggered by the set trigger mode, and all waveforms are output in the set order after triggering.
Gated Ext1/2	The duration of the output waveform is controlled by external signals, and the waveform is only output within the effective level. When the next effective level comes, the waveform that has not been output is continuously output or the waveform is played circularly.
Advanced	You can flexibly set the waiting event, playback mode and jumping event of each Scenario or Sequence or Segment as required, so that the waveform output is more flexible and changeable.

Note: Scenario and Sequence are only available when the layers are set to "Multilayer". so you need to purchase the " Multilayer " option to enable them.

12.8 Start Scenario/Segment

There are two starting numbers: "Segment starting number" and "Scenario starting number". "Segment start number" can be set when the level is "single layer", which is used to determine the first Segment waveform output; "Scenario Start Number" can be set when the hierarchy is "Multi-level", which is used to determine the first Scenario of the output.

Note: Scenario and Sequence are only available when the layers are set to "Multilayer". so you need to purchase the " Multilayer " option to enable them.

12.9 Trigger Mode

The trigger mode of AWG includes manual trigger, timer trigger and external trigger, and the trigger mode of Segment can be modified as required.

Table 12-12 trigger mode

Trigger Mode	Description
ManualA/B	It can be triggered by pressing <input type="text" value="Trig A"/> or <input type="text" value="Trig B"/> on the front panel; Or touch "Manual_A" or " Manual_B" on the screen.
Ext Trig1/2	Triggered by an external source, external signals are input by "Trig in 1" and "Trig in 2" on the back panel
Timer	Use internal timer trigger.

12.10 Dynamic Jump

The dynamic interface of the back panel is DB25, which is detailed in the following table:

Table 12-13 Description of dynamic interface parameters

Code jump input characteristics					
Trigger input					
parameter	minimum	typical	maximum	unit	Conditions and comments
interface type	DB25				
VIH	2		5	V	

VIL	0.5		0.8	V	
input impedance		10		k Ω	
Target quantity	256				
Polarity of strobe signal	Rising edge, falling edge				
Pulse width of strobe signal	50			ns	
Data setup/hold time	5			ns	
DB25 Pin arrangement					
Pin number	Signal description		Pin number	Signal description	
1	Gnd		14	Gnd	
2	Data bit 7, input		15	Strobe Signal, input	
3	Data bit 6, input		16	Retention	
4	Gnd		17	Gnd	
5	Data bit 5, input		18	Retention	
6	Data bit 4, input		19	Retention	
7	Gnd		20	Gnd	
8	Data bit 3, input		21	Retention	
9	Data bit 2, input		22	Retention	
10	Gnd		23	Gnd	
11	Data bit 1, input		24	Retention	
12	Data bit 0, input		25	Retention	
13	Gnd				

Dynamic jump has two jump modes: dynamic control and dynamic jump.

Dynamic Control: When the signal received by the dynamic interface of the back panel is the same as the pattern of the input serial number, the Segment waveform corresponding to the input serial number pattern will be output until the pattern of the next input serial number arrives, and the Segment waveform corresponding to the next segment serial number will be output.

Note: After the dynamic control is turned on, the pattern received by the dynamic interface of the back panel has no corresponding segment waveform in the dynamic jump table, and the initial segment waveform is always output.

Dynamic Jump: The signal received by the dynamic interface of the back panel is the same as the pattern of input serial number, and it will be played according to the trigger condition of the waveform

corresponding to the pattern of input serial number, and it will be played only once every time the pattern comes.

12.11 Wave (Data Source)

Click Segment to display the waveform in the item, and you can enter the data source selection interface. Data sources include built-in, from file and EasyWaveX.

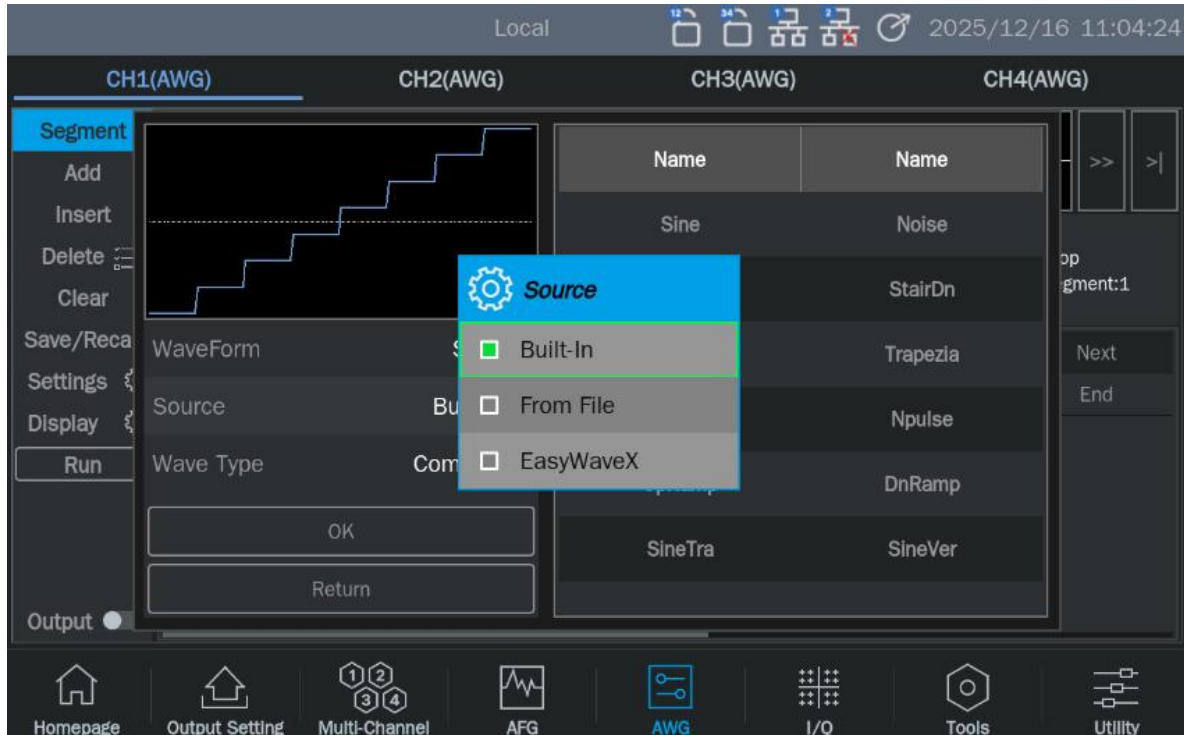

Built-In

Built-in waveform is a preset waveform in the signal generator, which is divided into several types, such as common use, mathematics, engineering, window function, trigonometric function, square wave, medical electronics, modulation, filter and demonstration, and there are various waveforms to choose from under each type.

Click the type parameter area of the "Wave Type" parameter setting box, and then select the waveform in the waveform list on the right. When a page cannot be displayed due to too many waveforms, a scroll bar will appear on the right side of the list. Scroll the list by operating the scroll bar up and down.

From File

The stored waveform is a waveform file saved by the user in a local directory, an external U disk, or a waveform file sent to the equipment by the upper computer software (EasyWaveX or SigIQPro) and

saved locally. When the data source is selected as "From File", the file manager window will be automatically called. Select the waveform file to be called in this window, and then click "Recall".

EasyWaveX

EasyWaveX, an arbitrary wave editing software, provides 12 standard waveforms such as Sine, Square, Ramp, Pulse, Noise and DC, which can meet the most basic requirements. At the same time, it also provides users with manual drawing, straight line drawing (including horizontal straight line, vertical straight line and two-point straight line), coordinate drawing (coordinates can be input by mouse or table, and there are two ways of connecting and smoothing) and equation drawing, which makes it easy to create complex waveforms.

The signal source not only supports the waveform issued by EasyWaveX software running on the upper computer, but also integrates EasyWaveX into the device, which supports editing and saving the waveform directly on the device. When the data source is "EasyWaveX", the EasyWaveX software will be automatically run on the device:



After editing the waveform in EasyWaveX, the waveform can be updated by the "Send Waveform to AWG" command under the "Communication" menu of the software. Click **File** > **Exit** in the menu bar of the software to exit. Because the screen is small, it is recommended to use the mouse to operate the software, or to operate it on the computer webpage through the WebServer.

For the use of EasyWaveX, please refer to the help of the software itself.

12.12 Length

Waveform length, that is, the number of waveform points, the minimum is 1024 points, and the maximum is 2G (4G matching) points. If it is less than 2048, it should be an integer multiple of 16. The set waveform length is different from that of the waveform file. After reading the waveform file, the waveform data will be interpolated or extracted to adapt to the set waveform length.

12.13 Loop

This parameter can set the number of cycles that the Scenario or Sequence or Segment plays continuously after reaching the trigger condition.

12.14 Start

When the level is "multi-level", set "Start Sequence Number" in the Scenario level to determine the first sequence output in the currently selected Scenario; Set "Start Sequence Number" in the Sequence layer to determine the first Segment output in the currently selected sequence.

12.15 Next

This parameter can set the playback order of Scenario or Sequence or Segment. "Next" and "start segment" in "single layer" can set the playing order of all waveforms as required; "Next" and "Start" in "Multi-layer" can set the playback order of all waveforms as required.

12.16 Wait Event

Set the trigger conditions for playing the current Scenario or Sequence or Segment.

Table 12-14 wait event

Wait Event	Description
Auto	Internal trigger source, automatic trigger.
Manual_A/B	It can be triggered by pressing "Trig A" or "Trig B" on the front panel; Or touch "Manual_A" or "Manual_B" on the screen.
Ext Trig_1/2	Triggered by external source, and external signals are input by "Trig in 1" and "Trig in 2" on the back panel.

Timer	Internal timer trigger. Scenario timing, Sequence timing and Segment timing can be set separately under Scenario, Sequence and Segment layers.
-------	--

Note: Only the mode of "Advanced" can be set.

12.17 Playback

There are three trigger events of playback mode: auto, single and conditional.

Table 12-15 playback

Playback	Description
Auto	Internal trigger source, automatic trigger.
Single	The waiting event of the current segment is the trigger condition, and the current segment is triggered and output once every time until the number of cycles of the current segment is output.
Conditional	The waiting event of the current segment is triggered by the trigger condition, and the current segment will be output until the trigger condition of the jump-out event is met. When the trigger condition of the jump-out event is met, the current segment being output will also be finished.

Note: Only the mode of "Advanced" can be set.

12.18 Out Event

Table 12-16 Out Event

Out Event	Description
Manual_A/B	It can be triggered by pressing "Trig A" or "Trig B" on the front panel; Or touch "Manual_A" or "Manual_B" on the screen.
Ext Trig_1/2	Triggered by external source, and external signals are input by "Trig in 1" and "Trig in 2" on the back panel.
Timer	Internal timer trigger. Scenario timing, Sequence timing and Segment timing can be set separately under Scenario, Sequence and Segment layers.

Note: Only the mode is "Advanced" and the playback mode is "Conditional" can be set.

12.19 Amplitude

The range of amplitude setting is different under different output modes. Please refer to this product data manual for details.

12.20 Offset

The range of offset setting in different output modes is different, and the offset here is only valid for the current segment.

12.21 Marker

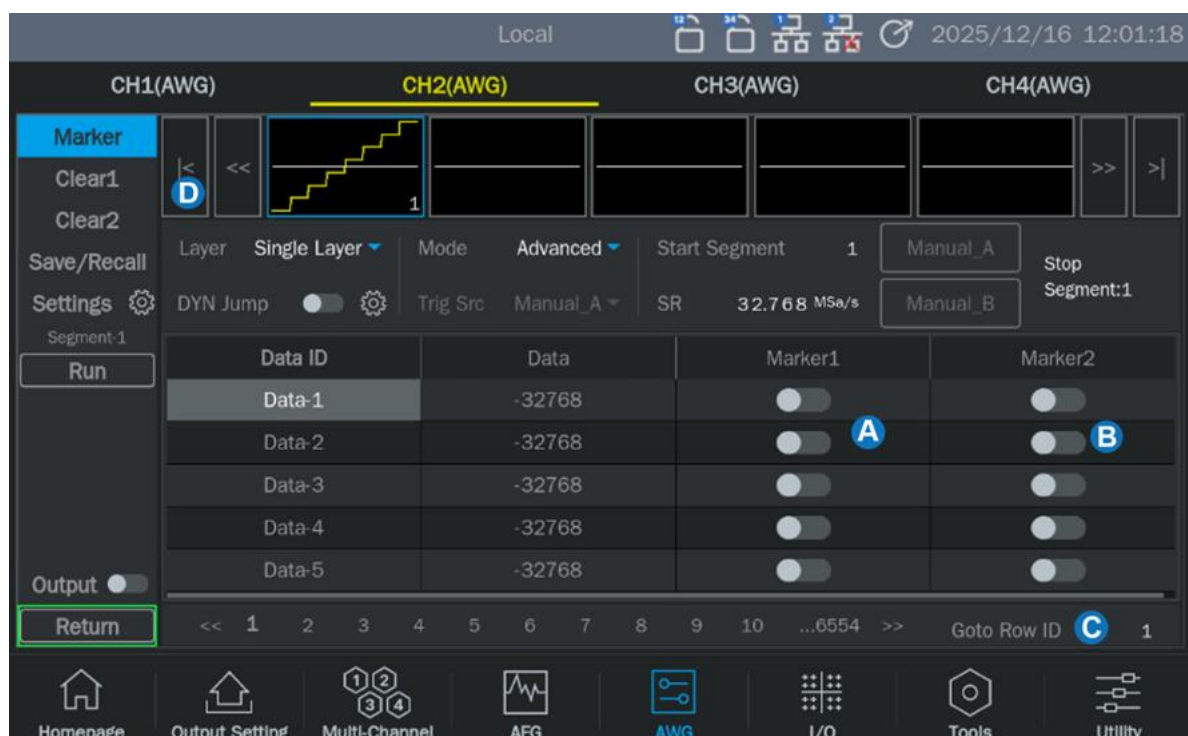

- Marker1 switch** You can choose to open one or more markers of the current Segment waveform.
- Marker2 switch** You can choose to open one or more markers of the current Segment waveform.
- Quick jump marker point** If necessary, enter the point to be marked for output, for example, the waveform length is 32,768, and the 16,384th point needs to be marked. Enter 16,384 here to jump to this point quickly.
- One-click clear marker** When new waveform points need to be re-marked, click **Clear1** or **Clear2** to remove all marked points.

Note: The use of marker needs to be used in conjunction with the marking settings in chapter (20 Output Setting).

13 IQ

The signal source can be used as an I/Q signal generator, providing I/Q vector signals for various debugging methods such as ASK, PSK, QAM, FSK, MSK, and Multitone, as well as signals for protocol types such as BlueTooth, Iot, LTE TDD, LTE FDD, 5G NR, IEEE.802.11. be, IEEE.802.11. ax, etc. The generation of I/Q signal source data can be facilitated by the upper computer software SigIQPro, and the signal source can be connected via USB or LAN.

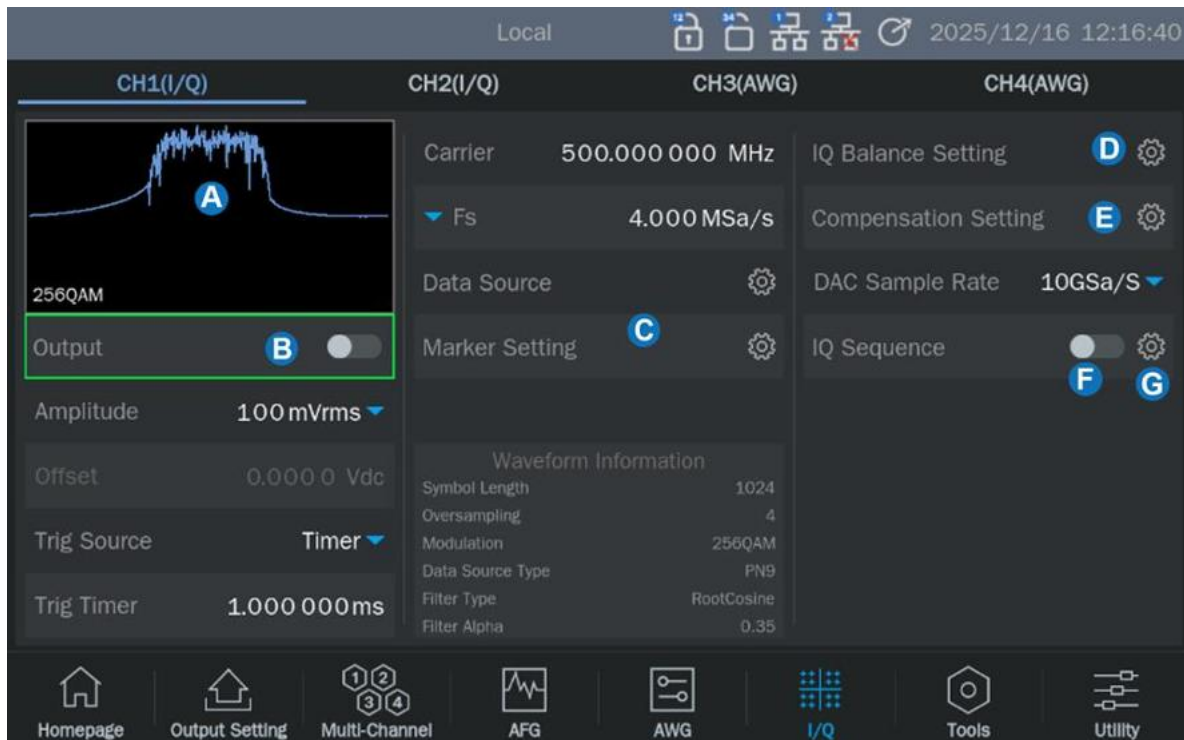

- A. Waveform spectrum preview
- B. out switch
- C. Parameter setting box
- D. IQ adjustment settings
- E. IQ compensation switch
- F. IQ sequence switch
- G. IQ sequence setting

IQ Parameter

The parameters of I/Q include center frequency, amplitude and symbol rate/sampling rate.

Table 13-1 IQ parameter description

IQ	
center frequency	The frequency of the carrier, when the center frequency is 0, the output is a baseband I/Q signal; When the center frequency is $\neq 0$, the output is a quadrature modulated IF signal. See the "Working Mode" section for the difference between them.
amplitude	When the center frequency =0, the amplitude value is the modulus $\sqrt{I^2 + Q^2}$ of I/Q signal; When the center frequency is $\neq 0$, the signal is only output from I channel, and the amplitude value is the root mean square value I_{rms} of I channel output.
Symbol rate/sampling rate	Symbol rate (F _{symb}) and sampling rate (F _s) are converted according to the Oversampling point, and the conversion relationship is $F_s = F_{\text{symb}} \times \text{Oversampling point}$. The information of waveform oversampling points can be read in "waveform information"

Waveform Information

The waveform information contains the modulation parameters of the waveform, including modulation type, symbol length, oversampling point, filter type and filter roll-off coefficient. Read-only.

Trigger Source

Trigger sources include Internal, Ext Trig_1/2, Manual_A/B and Timer.

Table 13-2 IQ waveform trigger source description

Trigger Source	Description
Internal	Internal trigger source, automatic trigger.
Ext Trig_1/2	It can be triggered by pressing "Trig A" or "Trig B" on the front panel; Or touch "Manual_A" or "Manual_B" on the screen.
Manual_A/B	Triggered by external source, and external signals are input by "Trig in 1" and "Trig in 2" on the back panel.
Timer	Internal timer trigger.

Data Source

Click the setting icon in the data source parameter setting box to enter the data source selection interface. You can choose to load the built-in waveform or the saved waveform.

Table 13-3 IQ waveform data source description

Data Source	Description
Built-in	Built-in waveform is a preset waveform in the signal generator, which includes many modulation waveforms such as ASK, PSK and QAM. The built-in waveform is selected in the same way as the built-in waveform of any wave.
From File	The stored waveform is a waveform file saved by the user in a local directory or an external USB flash drive, or a waveform file sent to the equipment by the upper computer (SigIQPro) and saved locally. The stored waveform is selected in the same way as the stored waveform of any wave.

13.1 Working Mode

I/Q signals can be output in two working modes. When the center frequency = 0, the working mode is baseband I/Q mode, at this time, CH1 is output as I channel and CH2 is output as Q channel; When the center frequency is $\neq 0$, the working mode is the intermediate frequency signal mode, and at this time, the I-channel signal and the Q-channel signal will be connected to the orthogonal modulator and modulated to the carrier before being output. The output of the quadrature modulator is output from CH1 after broadband compensation.

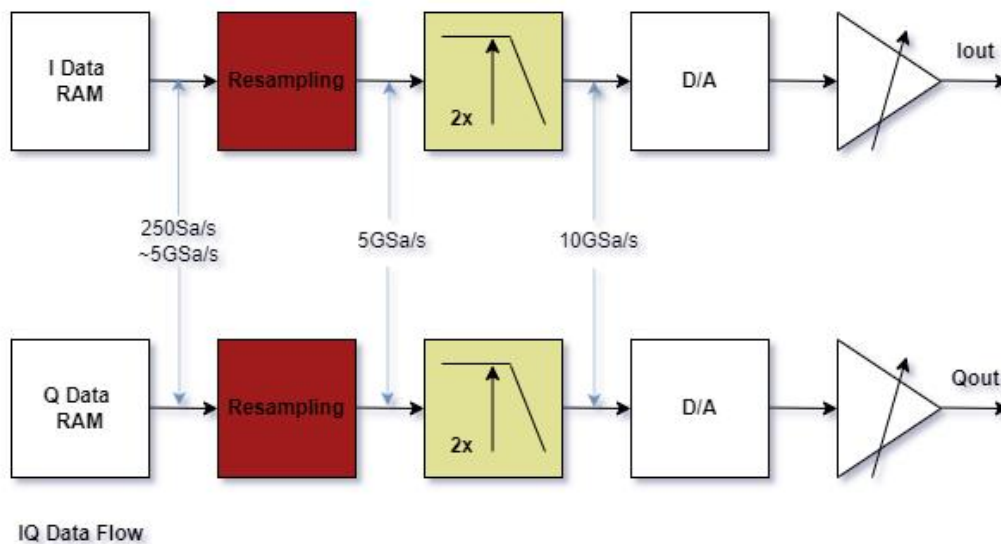

Figure 13-1 Baseband IQ mode

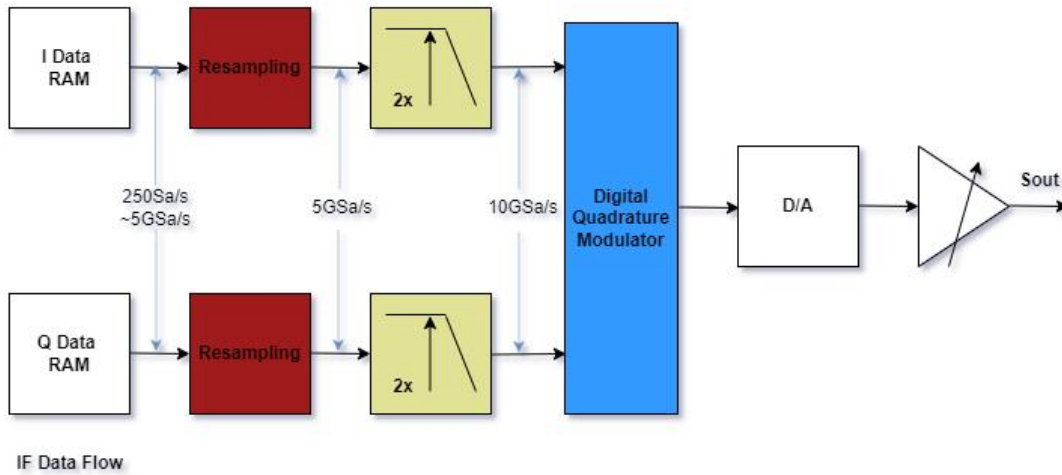

Figure 13-2 Intermediate frequency mode

The schematic block diagram of the quadrature modulator is shown below:

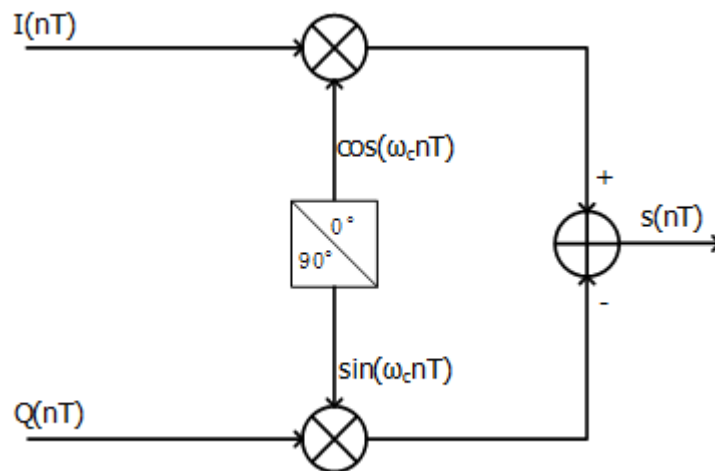

Figure 13-3 Principle block diagram of quadrature modulator

13.2 IQ Balance

In baseband I/Q working mode, SDG8000A provides the option of I/Q balance adjustment, which is used to suppress the image caused by the imbalance of I/Q channels to the greatest extent.

Table 13-4 IQ balance

IQ Balance	Description
Gain Balance	Amplitude gain balance, which regulates the amplitude difference between I/Q channels, in dB.

I Offset	I-channel DC bias is adjusted jointly with Q-channel DC bias to compensate the bias imbalance of I/Q channels.
Q Offset	Q-channel DC bias
Q Angle	The phase angle of Q channel is adjusted to compensate the phase imbalance of I/Q channel.

13.3 IQ Sequence

Like AWG, IQ supports three levels of nested Sequence output: Scenario, sequence and Segment, which makes IQ output more flexible.

Refer to "12AWG" for specific instructions.

13.4 SigIQPro

I/Q waveform editing software SigIQPro supports 2ASK, 4ASK, 8ASK, BPSK, QPSK, 8PSK, DBPSK, DQPSK, D8PSK, 8QAM, 16QAM, 32QAM, 64QAM, 128QAM, 256QAM, 2FSK, 4FSK, 8FSK, 16FSK, MSK, I/Q data generation of MultiTone and other modulation types, as well as signal editing and generation of BlueTooth, IoT, LTE TDD, LTE FDD, 5NR, IEEE.802.11.be, IEEE.802.11.ax and other protocol types, and directly download the generated data to the signal source for output.

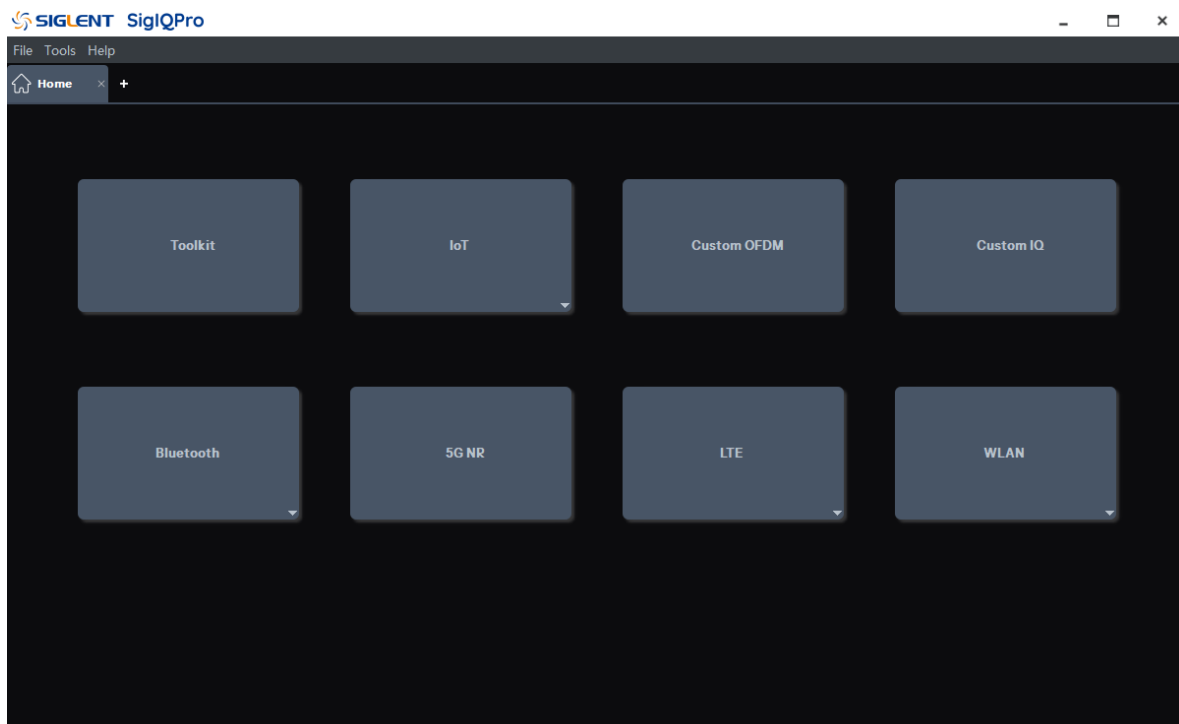

For a detailed description of the use of SigIQPro, please refer to the help of the upper computer software itself.

14 MOD/SWEEP/BURST

14.1 Overview

Mod, sweep and burst can all be regarded as modulation of carrier. In addition to conventional modulation, sweep is a special frequency/amplitude modulation, and burst is a pulse modulation.

The signal source provides a wealth of modulation functions, including AM, DSB-SC, FM, PM, FSK, ASK, PSK and PWM. According to different modulation types, different modulation parameters need to be set. In amplitude modulation, the amplitude modulation frequency, modulation depth, modulation waveform and source type can be set; In frequency modulation, the frequency modulation frequency, frequency deviation, modulation waveform and source type can be set; During phase modulation, the phase modulation frequency, phase deviation, modulation waveform and source type can be set; During frequency shift keying modulation, the keying frequency, frequency hopping frequency and source type can be set; During amplitude shift keying modulation, the keying frequency, carrier frequency and source type can be set; During phase shift keying modulation, the modulation rate, polarity and source type can be set; During pulse width modulation, modulation frequency, pulse width/duty ratio deviation, modulation waveform and source type can be set. The different modulation types are introduced one by one, with emphasis on their parameter settings.

14.2 Mod

The signal source supports commonly used analog modulation (AM/DSB-SC/FM/PM/PWM) and digital key control (ASK/FSK/PSK). The modulated source can be selected from internal, external and channel.

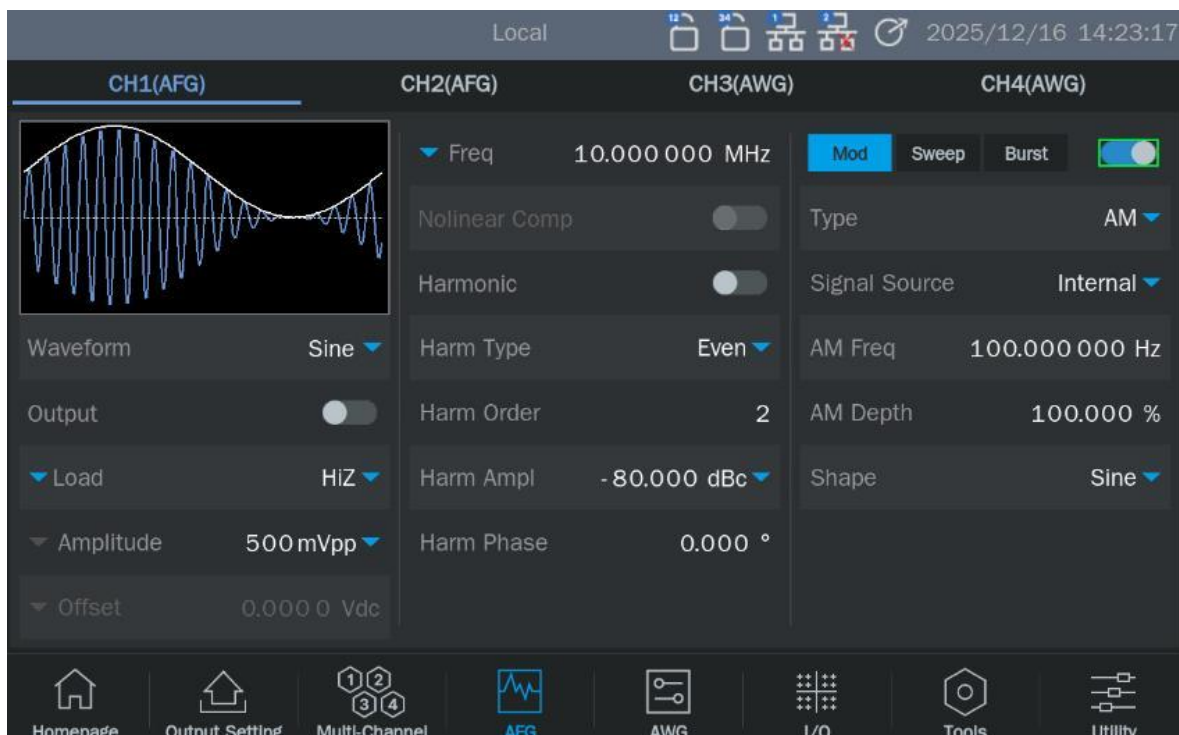

14.2.1 Signal Source

The sources of modulated waves are: internal, external and channel. See the table below for details:

Table 14-1 Modulation wave source and description

Signal Source	Description
Internal	The modulation signal is generated internally from DDS module, and the corresponding modulation wave is generated according to the user's configuration (modulation frequency, modulation waveform).
External	<p>The modulation signal is externally input.</p> <p>When the modulation type is analog modulation (AM/DSB-SC/FM/PM/PWM, etc.), the external source is input from the external modulation interface. The amplitude of the input analog signal determines the modulation coefficient (modulation depth/frequency deviation/phase deviation/pulse width deviation, etc.). For the requirements of external modulation amplitude, please refer to the parameter "corresponding amplitude when 100% modulation" in the data manual.</p> <p>When the modulation type is digital control (ASK/FSK/PSK, etc.), the external source is input from the external trigger interface. The input external signal must meet the electrical requirements of the external trigger interface (see the data sheet for details).</p>
CH	The modulated signal is output by other channels of the equipment. CH1 can only choose CH2 as the modulation signal, and CH2 can only choose CH1 as the modulation signal; Similarly, CH3 can only choose CH4 as the modulation signal, and CH4 can only choose CH3 as the modulation signal.

Table 14-2 Description of 100% modulation

	Description
AM	Corresponding to the case of modulation depth =100%
FM	Corresponding frequency offset = setting frequency offset. For example, the amplitude of external modulation input is 50% of the corresponding amplitude when 100% modulation is performed, and the obtained frequency offset is 50% of the set frequency offset.
PM	Corresponding phase offset = the case of setting phase offset. For example, the amplitude of external modulation input is 50% of the corresponding amplitude when 100% modulation is performed, and the obtained phase offset is 50% of the set phase offset.

14.2.2 Modulation Type

The following table shows the modulation types supported by signal sources and their compatibility with carriers.

Table 14-3 Compatibility relationship between modulation type and carrier

Type \ carrier wave	Sine	Square	Pulse	Ramp	Noise	Arb
AM	●	●	●	●	●	●
DSB-SC	●	●	●	●		●
FM	●	●		●		●
PM	●	●		●		●
PWM			●			
FSK	●	●		●		●
ASK	●	●	●	●		●
PSK	●	●		●		●

AM

AM is amplitude modulation, which is a modulation method that uses the amplitude of modulated wave to control the amplitude of carrier wave.

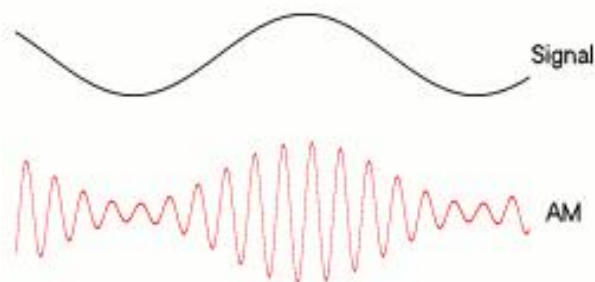

The settable parameters of am are as follows:

Table 14-4 AM modulation parameter description

AM	
AM Depth	Also known as amplitude modulation coefficient (m), it is determined by the maximum $U_{cm,max}$ and minimum $U_{cm,min}$ values of amplitude modulation wave envelope:

	$m = \frac{U_{cm,max} - U_{cm,min}}{U_{cm,max} + U_{cm,min}}$ <p>When source = internal or channel, this value can be set directly; When the source = external, it is determined by the amplitude of external modulation input.</p>
<p>AM Freq</p>	<p>Frequency of modulated wave.</p> <p>When source = internal, this value can be set directly; When source = external or channel, it is determined by the frequency of external modulation input or another channel.</p>
<p>Shape</p>	<p>The shape of the modulated wave.</p> <p>When source = internal, this value can be set directly; When the source = external, it is determined by the external modulation input or the waveform of another channel.</p>

The amplitude strategy of AM is to keep the power of carrier consistent with that of unmodulated, that is, the power of carrier has nothing to do with modulation depth. In this way, the peak value of AM waveform will exceed the set value, which is a normal phenomenon. The following figure shows the amplitude comparison of 60 MHz and 0 dBm carrier with no modulation and 100% modulation depth. It can be seen that the peak-to-peak value in time domain becomes larger after modulation is turned on, but the power of carrier in frequency domain remains unchanged.

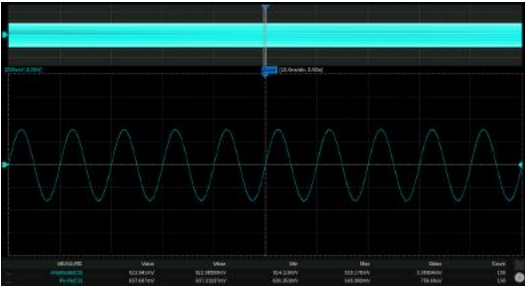

Unmodulated time domain diagram

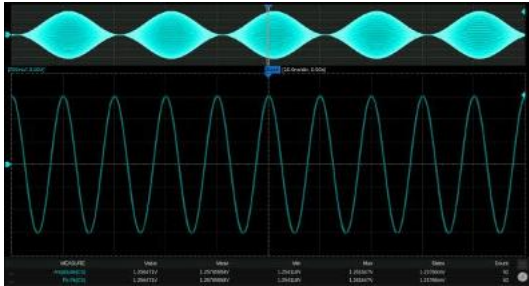

100% modulation depth time domain diagram

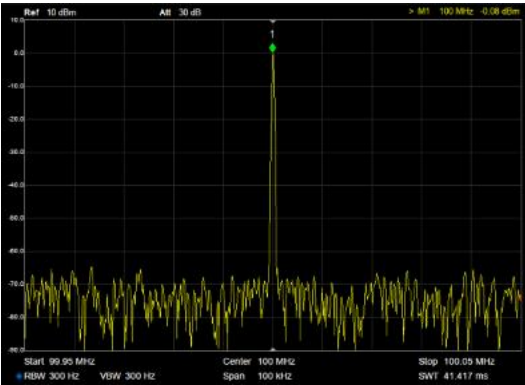

Unmodulated spectrogram

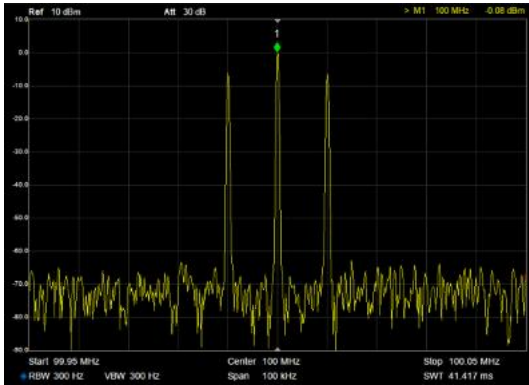

100% modulation depth spectrogram

DSB-SC

DSB-SC is double sideband amplitude modulation of suppressed carrier.

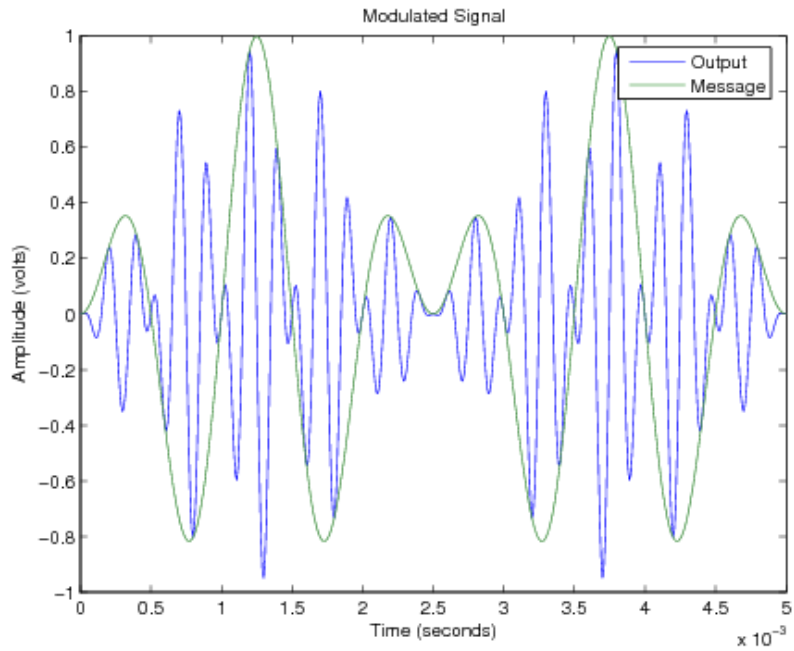

The configurable parameters of DSB-SC are as follows:

Table 14-5 Description of modulation parameters of DSB-SC

DSB-SC	
DSB-SC Freq	Same as AM
Shape	Same as AM

FM

FM is frequency modulation, which is a modulation method that uses the amplitude of modulated wave to control the frequency of carrier wave.

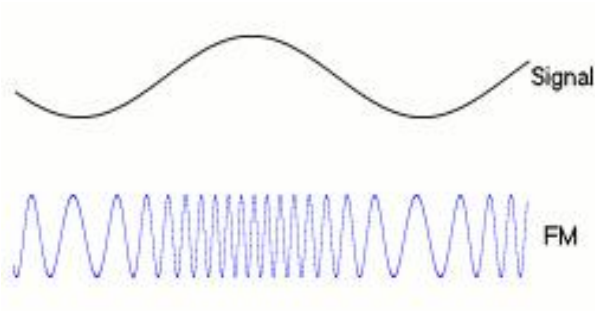

The configurable parameters of FM are as follows:

Table 14-6 Description of FM modulation parameters

FM	
FM Freq	Same as AM
Shape	Same as AM
Freq Dev	<p>The instantaneous frequency deviates from the maximum value Δf of carrier frequency f_c, and when the frequency deviation reaches, it corresponds to the maximum or minimum value of modulation wave amplitude. The modulated carrier frequency varies within the range $f_c \pm \Delta f$.</p> <p>When source = internal or channel, this value can be set directly; When the source = external, it is determined by the amplitude of external modulation input, and the full amplitude of external modulation corresponds to the set frequency deviation.</p>

PM

PM is phase modulation, which uses the amplitude of modulated wave to control the instantaneous phase of carrier wave.

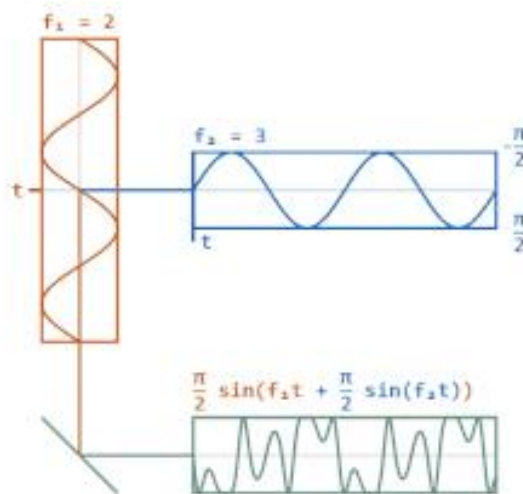

The settable parameters of PM are as follows:

Table 14-7 Description of PM modulation parameters

PM	
PM Freq	Same as AM
Shape	Same as AM

Phase Dev	<p>The instantaneous phase deviates from the maximum value $\Delta\phi$ of the instantaneous phase $\phi_c(t)$ when the carrier is not modulated, and when the phase deviation reaches, it corresponds to the maximum or minimum value of the amplitude of the modulated wave. The modulated carrier phase changes in the range $\phi_c(t) \pm \Delta\phi$.</p> <p>When source = internal or channel, this value can be set directly; When the source = external, it is determined by the amplitude of external modulation input, and the full amplitude of external modulation corresponds to the set phase deviation.</p>
-----------	--

PWM

PWM is pulse width modulation, which is only applicable to the case of carrier = Pulse, and refers to the modulation method that uses the amplitude of modulation wave to control the positive pulse width of carrier.

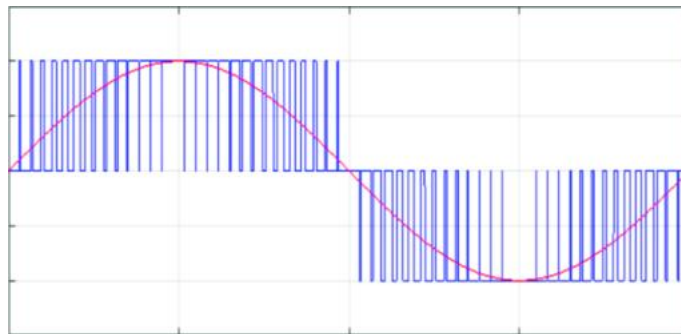

The settable parameters of PWM are as follows:

Table 14-8 Description of PWM modulation parameters

PWM	
PWM Freq	Same as AM
Shape	Same as AM
Width Dev	<p>The positive pulse width deviates from the maximum value of the positive pulse width without modulation, and when the pulse width deviation reaches, it corresponds to the maximum or minimum value of the amplitude of the modulated wave.</p> <p>When source = internal or channel, this value can be set directly; When the source = external, it is determined by the amplitude of external modulation input, and the full amplitude of external modulation corresponds to the set pulse width deviation.</p>

ASK

ASK is amplitude keying, specifically binary amplitude keying here. The amplitude of the modulated carrier changes with the 1/0 state of the binary sequence, that is, the presence or absence of carrier amplitude represents 1 or 0.

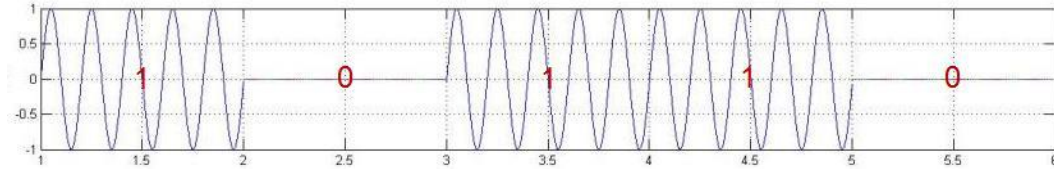

The settable parameters of ASK are as follows:

Table 14-9 ASK parameter description

ASK	
Key Freq	The bit rate of the binary sequence. When the source = internal, this value can be set directly, and the internal source is a clock sequence with a specified frequency; When the source = external, it is determined by the 0/1 state of the external trigger port input.

FSK

FSK is frequency keying, here refers to binary frequency shift keying. The frequency of the modulated carrier varies with the 1/0 state of the binary sequence, i.e. a carrier frequency of f_0 means that 0 is transmitted and a carrier frequency of f_1 means that 1 is transmitted.

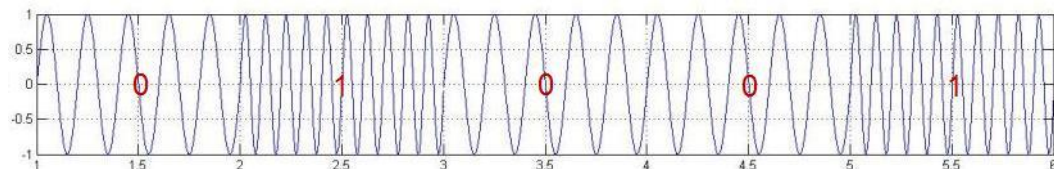

The configurable parameters of FSK are as follows:

Table 14-10 FSK parameter description

FSK	
Key Freq	Same as ASK
Hop Freq	The frequency representing 1, i.e. f_1 . The frequency representing 0 (i.e. f_0) is the currently set carrier frequency.

PSK

PSK is phase shift keying, here refers to binary phase shift keying. The instantaneous phase of the carrier being modulated varies with the 1/0 state of the binary sequence.

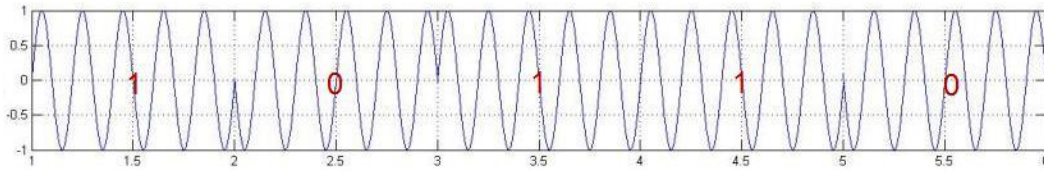

The settable parameters of PSK are as follows:

Table 14-11 PSK parameter description

PSK	
Key Freq	Same as ASK
Polarity	Positive phase/inverse phase. In normal phase, the phase is 0 when it changes from 0 to 1; When changing from 1 to 0, the phase is 180; When the phase is reversed, it is opposite.



Application example: output a FM wave, the modulation source is internal, and the parameters are as follows:

- Carrier waveform = Sine, frequency = 10 MHz
- Modulated wave waveform = triangle, frequency = 1 MHz, frequency deviation = 1 MHz

1. Set "Mod" to "On"
2. Set "Type" to "FM"
3. Set "Source" to "Internal"
4. Set the "FM Freq" to 1 MHz
5. Set "Freq Dev" to 1 MHz
6. Set "Shape" to "Triangle"
7. Open the output

Follow the above steps to output the expected FM waveform. The modulation parameters page after setting is as follows:

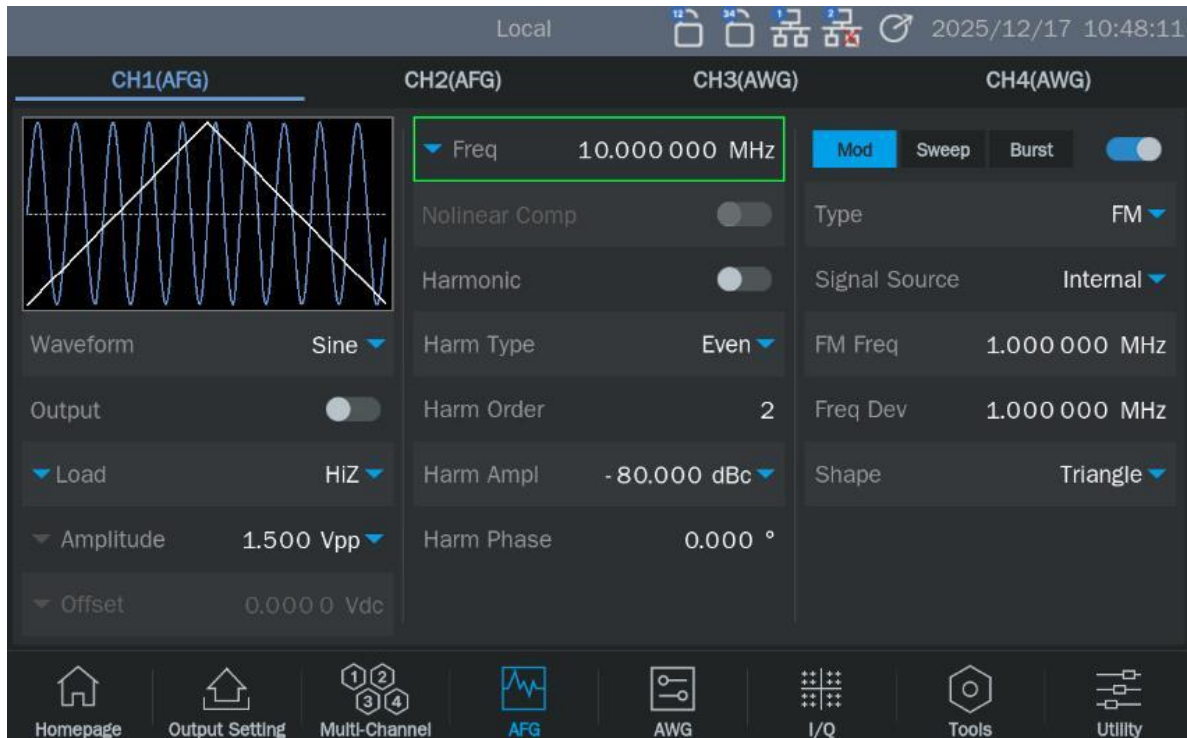

Application example: output an AM wave, the modulation source is external, and the parameters are as follows:

Carrier waveform = Sine, frequency = 20 kHz

Waveform of modulated wave = Sine, frequency = 1 kHz, and modulation depth = 50%

1. Set the carrier's "waveform" as Sine and "frequency" as 20 kHz on the carrier's parameter setting page.;
2. Enter the interface of modulation/scanning/pulse train setting, and set "Mod" to "ON".
3. Set "modulation type" to "AM".
4. Set "source selection" as "external", and set the waveform of external input modulation signal as Sine and the frequency as 1 kHz. Looking up the data sheet, the external input amplitude of 10 Vpp corresponds to 100% modulation, so setting the amplitude of external modulation signal to 5 Vpp can get 50% modulation depth. The external modulation signal can be provided by another signal source.
5. Open output.

Follow the above steps to output the expected FM waveform. The modulation parameters page after setting is as follows. Note that the frequency, shape and depth of the modulated wave at this time are completely determined by the external modulated input signal, so the relevant parameters are no longer displayed on the setting page.

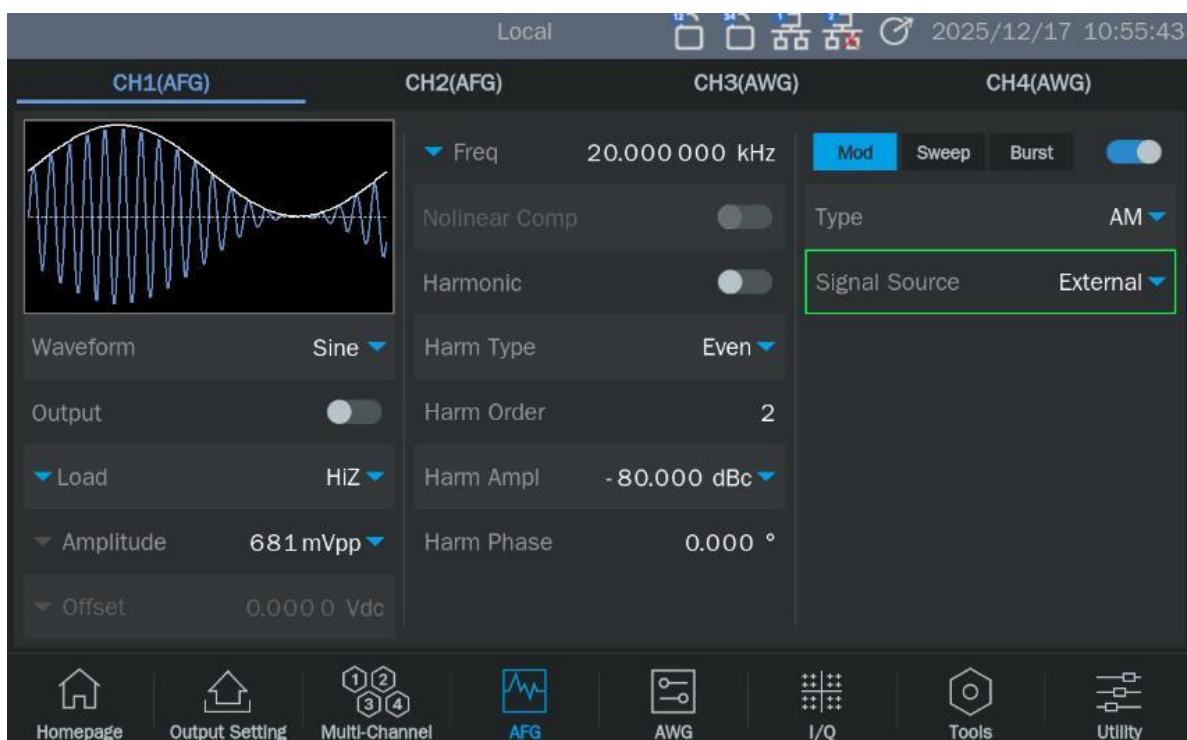

14.3 Sweep

Sweep belongs to special frequency modulation (FM) or amplitude modulation (AM). When the frequency sweep is turned on, the carrier output frequency or amplitude can be scanned according to the set mode (linear/log/step) and can be controlled by the trigger signal. .

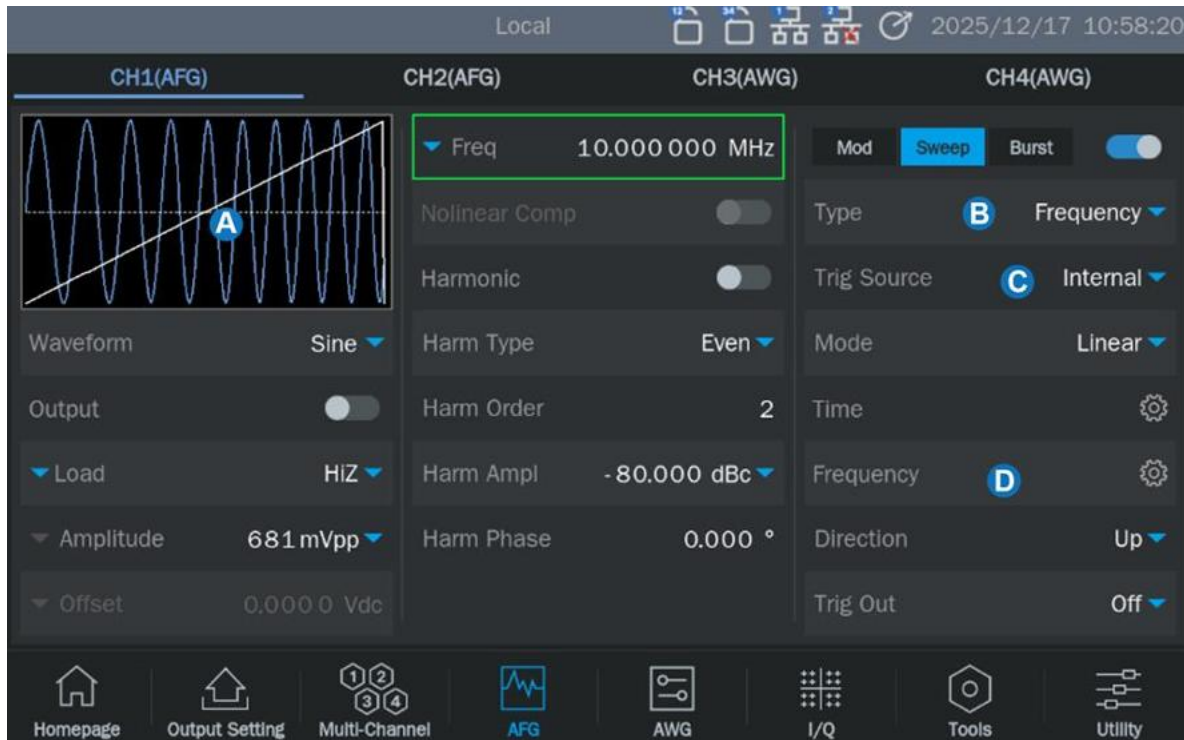

- A. Waveform preview
- B. Sweep mode setting box
- C. Trigger source setting box
- D. Sweep parameter setting box

14.3.1 Sweep Type

The sweep types are divided into frequency, amplitude and freq&l. See the table below for details:

Table 14-12 sweep type

Sweep type	Description
Frequency	A special frequency modulation (FM)
Amplitude	A Special Amplitude Modulation (AM)
Freq&Ampl	Frequency and amplitude sweep

14.3.2 Sweep Mode

There are three scanning modes: linear, log and step. See the table below for details:

Table 14-13 sweep mode

Sweep mode	Description
Linear	This means that the modulating waveform is a sawtooth, which controls the frequency moves from the start frequency to the stop frequency following Linear variation.
Log	The frequency variation follows a 10x law and is often used for frequency response testing. The frequency response is generally plotted in logarithmic coordinates (10 octaves), so to see the frequency response in a logarithmic plot, a uniform distribution of sample points requires the use of a logarithmic sweep. (Only frequency sweep is supported)
Step	The output signal frequency varies in a stepped manner from the start frequency to the end frequency. The frequency points are controlled by the "Step Number".

14.3.3 Trigger Source

There are three trigger sources for scanning: internal, external and manual. See the table below for details:

Table 14-14 Trigger source of sweep

Trigger Source	Description
Internal	The sweep cycle is controlled by the internal timer
Ext Trig_1/2	The signal generator receives the trigger input on the rear panel and outputs a frequency sweep every time it receives the trigger edge (rising or falling edge determined by the edge setting) of a CMOS pulse. When the trigger signal arrives, the signal generator outputs the carrier of the start frequency. After the start hold time, it starts sweeping. The frequency changes from the start frequency to the stop frequency then maintains the stop frequency until the end hold time has expired. Then it outputs the offset value, and starts frequency sweeping again after the back time has expired.
Manual_A/B	When the trigger source is manual, a trigger button will appear on the parameter page, and the frequency sweep will be output every time the button is pressed. When the trigger signal arrives, the signal generator outputs the carrier of the start frequency. After the start hold time, it starts

	sweeping, the frequency changes from the start frequency to the stop frequency, then maintains the stop frequency for the end hold time. And then outputs the offset value, and starts frequency sweeping again after the back time has expired.
--	--

14.3.4 Sweep parameter setting

See the table below for scanning parameters and their detailed descriptions:

Table 14-15 Parameters and description of the sweep

Sweep Parameters	Description
Sweep time	The time spent from the start frequency sweep to the stop frequency. (So is amplitude sweep)
Start Hold Time	The time that the output signal maintains the starting frequency before sweeping. (So is amplitude sweep)
End Hold Time	The time that the output signal maintains the stop frequency after finishing sweeping. (So is amplitude sweep)
Back Time	After end hold time, the device outputs the offset value and stays in this status for back time, and then restart sweep. (So is amplitude sweep)
Start Freq /Center Frequency/ Stop Freq / Freq Span	The frequency parameter of the sweep. The relationships are as follows: Center frequency = (start frequency + stop frequency)/2 Frequency span = stop frequency - start frequency (So is the amplitude parameter of amplitude sweep)
Sweep direction	There are three modes: "Up", "Down", and "Up and Down". Up means that the frequency is swept from low to high; Down means that the frequency is swept from high to low; Up and Down mode is only applicable to linear sweep, where the frequency is first swept from the start frequency to the stop frequency and then back to the start frequency. This mode is equivalent to FM with a triangular waveform as the modulating source The symmetry of the sweep cycle can be set (So is the amplitude parameter of amplitude sweep)
Trigger output	When the trigger source = internal or manual, the trigger signal can be output from the trigger output on the rear panel. The trigger edge corresponds to the start of the scan
Freq Marking	The marker from the Marker port on the front panel is synchronized with the specified frequency. Click on the  to set the marker frequency



Application example: A sine wave is output with linear and logarithmic sweeps respectively, with the following parameters

Sweep direction = Up, start frequency = 100 Hz, stop frequency = 100 kHz

Sweep time = 3 ms

Trigger source = internal, trigger output = on

1. Set the carrier "waveform" to "Sine" in the CH1 carrier parameter setting page
2. Enter the modulation/sweep/burst settings and set "Sweep" to "On"
3. Set "Type" to "Linear"
4. Set "Source" to "Internal"
5. Set "Sweep Time" to 3 ms
6. Set "Start Hold Time", "End Hold Time", "Back Time" to 0 s
7. Set "Direction" to "Up"
8. Set "Start Freq" to 100 Hz and the "Stop Freq" to 100 kHz
9. Turn on the trigger output. Use the rising edge of the trigger output to synchronize with the start frequency and use it to trigger the oscilloscope to observe a stable sweep signal
10. Turn on the output of CH1 and observe the result
11. Change the "Type" to "Log" and observe the results

Follow these steps to generate the desired sweep signal. Once set up the linear sweep parameters page is as follows. The parameters for the logarithmic sweep differ only in the "Type" field.

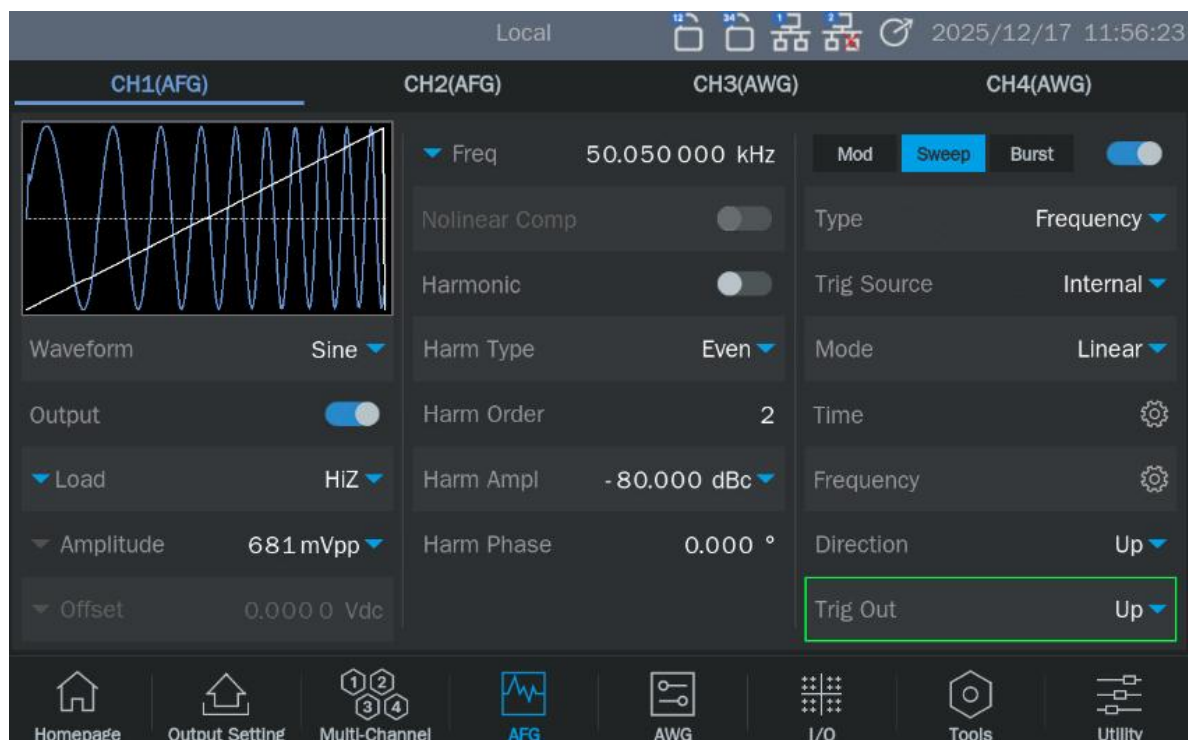

The results of the sweep output are as follows: (red traces are sweep signals, blue traces are trigger signals).

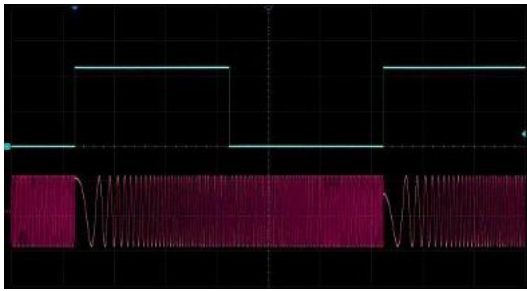

Linear sweep

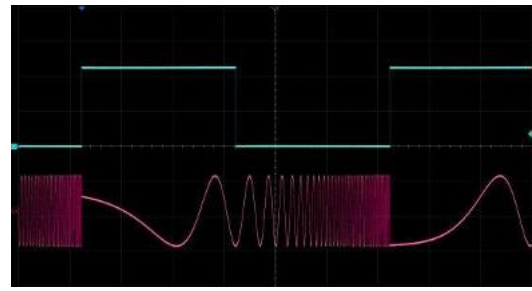

Log sweep

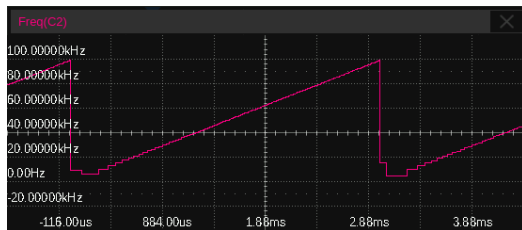

Linear sweep frequency vs. time

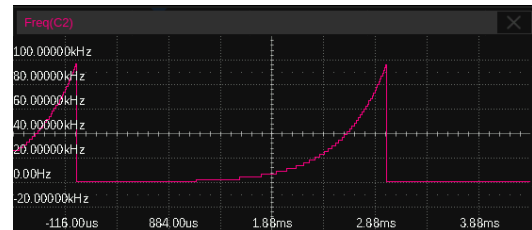

Log sweep frequency vs. time

This example will help the users to better understand the difference between a linear sweep and a logarithmic sweep: scanning from 100 Hz to 100 kHz with a sweep time of 3 ms increases the frequency by a factor of 10^3 and by a factor of 10 for every 1 ms in a logarithmic sweep. The table below shows the frequency values corresponding to each time point in logarithmic and linear sweep mode.

Time (ms)	0	1	2	3
Frequency (Hz)-- Logarithmic sweep	100	1000	10000	100000
Frequency (Hz)-- Linear sweep	100	33400	66700	100000

14.4 Burst

Burst is a signal train with several cycles. The burst train can be triggered by internal, external, or manual triggers.

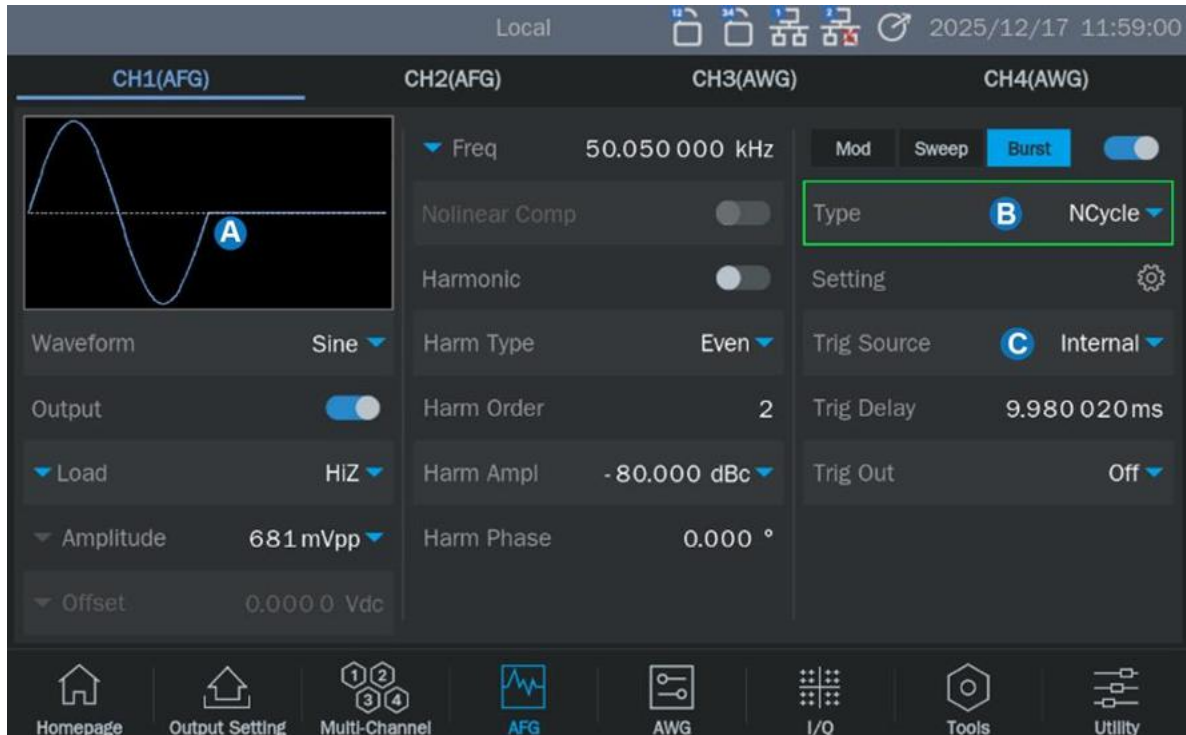

- A. Waveform preview
- B. Burst type setting box
- C. Trigger source setting box

14.4.1 Burst Type

Burst types are divided into N-cycle and gated. See the table below for details:

Table 14-16 Burst Type

Burst Type	Description
NCycle	Outputs a specified number (N) of carrier cycles.
Gated	The carrier outputs only if the gating signal is valid. The gating signal can be active high or active low.

14.4.2 Trigger Source

Burst uses three kinds of trigger sources: internal, external, and manual. The use method is similar to

frequency sweep. See the following table for details:

Table 14-17 Trigger sources for Burst

Trigger Sources	Description
Internal	The burst train output is controlled by an internal timer.
Ext Trig_1/2	The generator receives the trigger/gating signal from the rear panel of the instrument. When used as a trigger signal, each time a trigger edge of a CMOS pulse is received, a burst signal is output. When used as a gating signal, the high or low level of the signal is used to determine whether or not to output the carrier.
Manual_A/B	When triggering manually, a trigger button will appear in the parameter setting area and each press of this button will trigger one burst.

14.4.3 Burst Parameter Setting

Burst parameters and their detailed descriptions are shown in the following table:

Table 14-18 Parameters and description of Burst

Burst parameters	Description
Start phase	Initial phase at the start of the burst
Burst Period	This parameter is used to set the period of the burst signal (i.e. time interval between burst trains).
Cycles	This parameter is only available when Burst type = N cycles and is used to specify the number of periods each burst contains. The number of periods can be set to "infinite" by clicking on the parameter name field of the parameter setting box, indicating that a continuous carrier will be the output after the trigger is received.
Counter	This parameter is only available when trigger source = External or Manual. This parameter is used to specify the number of burst trains will be output at every trigger.
Polarity	This parameter is only available when Burst type = Gated and is used to specify the polarity of the gated signal. When polarity = positive, the carrier signal is only output when gated high; when polarity = negative, the carrier signal is only output when gated low
Trigger delay	This parameter is used to set the delay time from the trigger edge to the head of the burst. The minimum value of the trigger delay represents the minimum delay that can be achieved in hardware.

Trigger output	This parameter is only available when the trigger source = internal or manual, and can be set to Up (rising edge align), Down (falling edge align), or Off (disable trigger output).
Edge	This parameter is only available when the trigger source = external and is used to specify the rising edge or falling edge as the trigger edge.
Hold Value	This parameter is used to specify the output signal at the end of the burst. It can be set to Start Value (start of the burst), End Value (end of the burst), and Middle Value (the Offset value).



Application example: 10 kHz sine waveform as the carrier, with a burst output every 10 ms, each burst containing 5 periods

1. Set "Waveform" of the carrier to "Sine" and "Frequency" to 10 kHz in the parameter setting page of the carrier.
2. Enter the Modulation/Sweep/Burst settings and set "Burst" to "On"
3. Set "Type" to "NCycle"
4. Set "Source" to "Internal"
5. Set "Burst Period" to 10 ms
6. Set "Cycles" to 5
7. Set "Trig Out" to "Up", turn on the trigger output. Use the rising edge of the trigger output to trigger the oscilloscope to steadily capture the burst signal
8. Turn on the channel output and observe the results

Follow these steps to generate the desired burst signal. The burst parameters page after the setup is shown below.

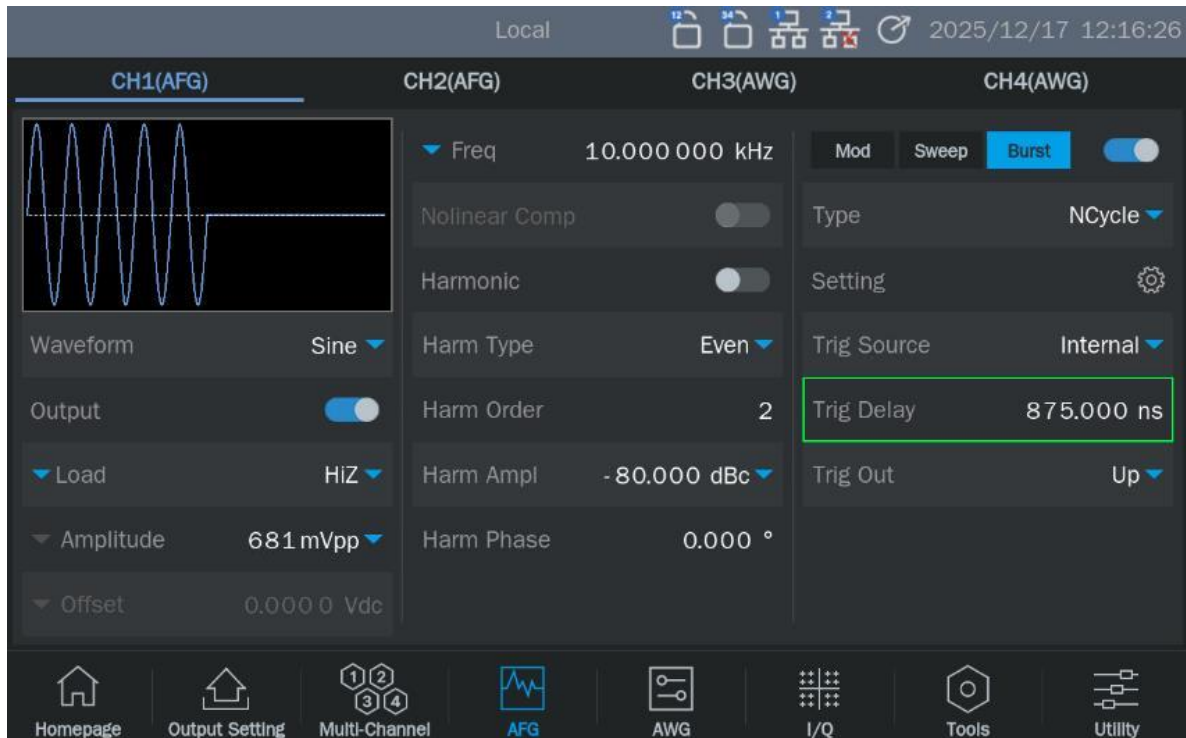

The results of the burst output are as follows: (red trace is the burst signal and blue trace is the trigger signal).

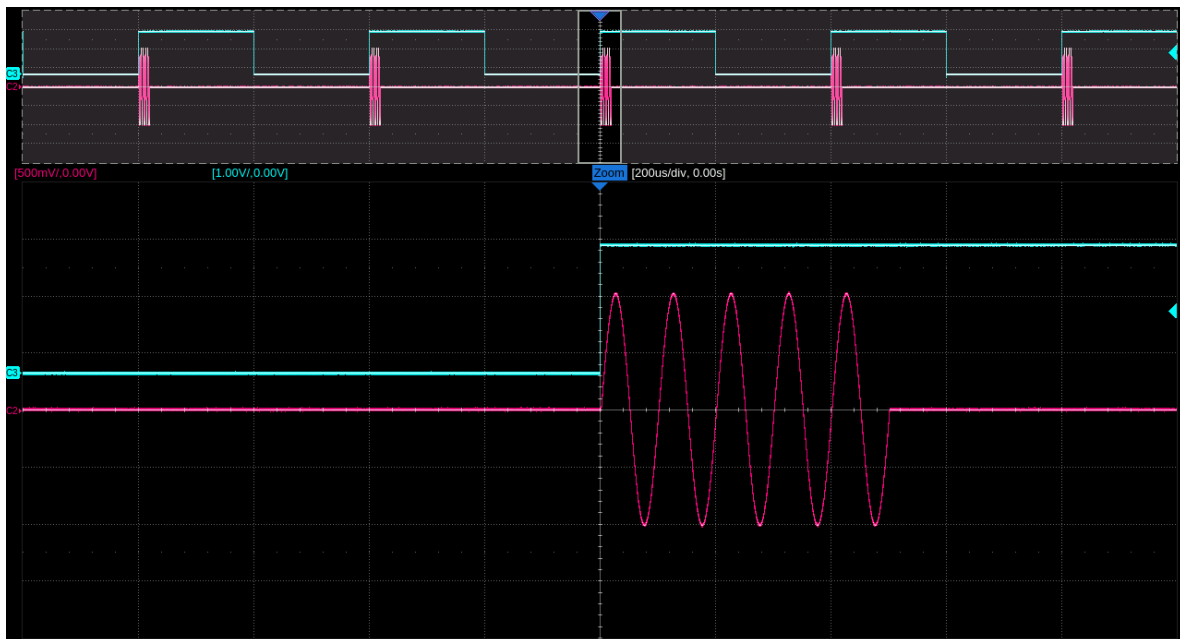

Application example: Manual trigger, 3 burst trains per trigger, 10 ms interval between burst trains and each burst contains 10 pulses, carrier frequency 10 kHz, pulse width 20 us

1. Set "Waveform" of the carrier to "Pulse", "Frequency" to 10 kHz, and "Pulse Width" to 20 us in the

- parameter setting page of the carrier.
2. Enter the Modulation/Sweep/Burst settings screen and set "Burst" to "On"
 3. Set "Type" to "NCycle"
 4. Set "Source" to "Manual"
 5. Set "Burst Period" to 10 ms
 6. Set "Cycles" to 10
 7. Set "Counter" to 3
 8. Set "Trig Out" to "Up", turn on the trigger output. The rising edge of the trigger output is synchronized with the burst sequence and can be used as a trigger signal to capture the burst
 9. Open channel output
 10. Click on the trigger button in the bottom right corner of the setup page and use the trigger output signal on the oscilloscope as a trigger for a single capture

Follow these steps to generate the desired burst signal. The burst parameters page after the setup is shown below.

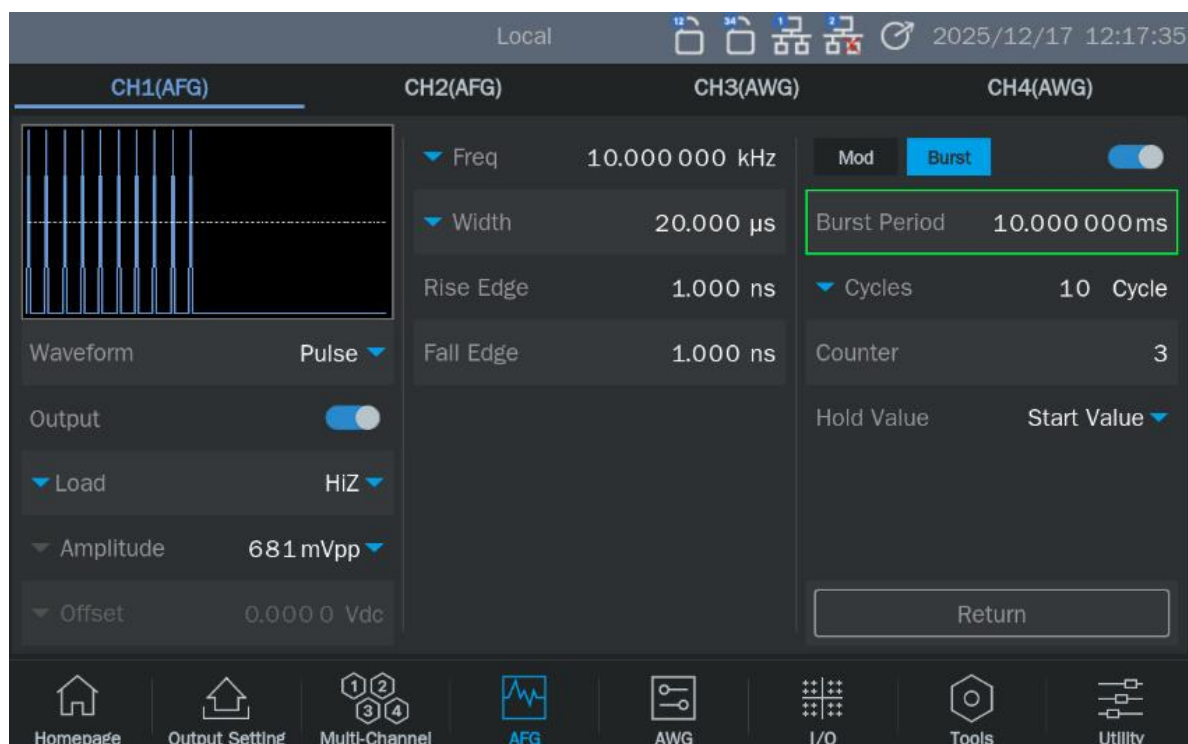

The result of the burst output is shown below (the red trace is the burst signal and the blue trace is the trigger signal). As you can see, in this example, multiple bursts can be obtained with a single trigger, each containing a specified carrier period.

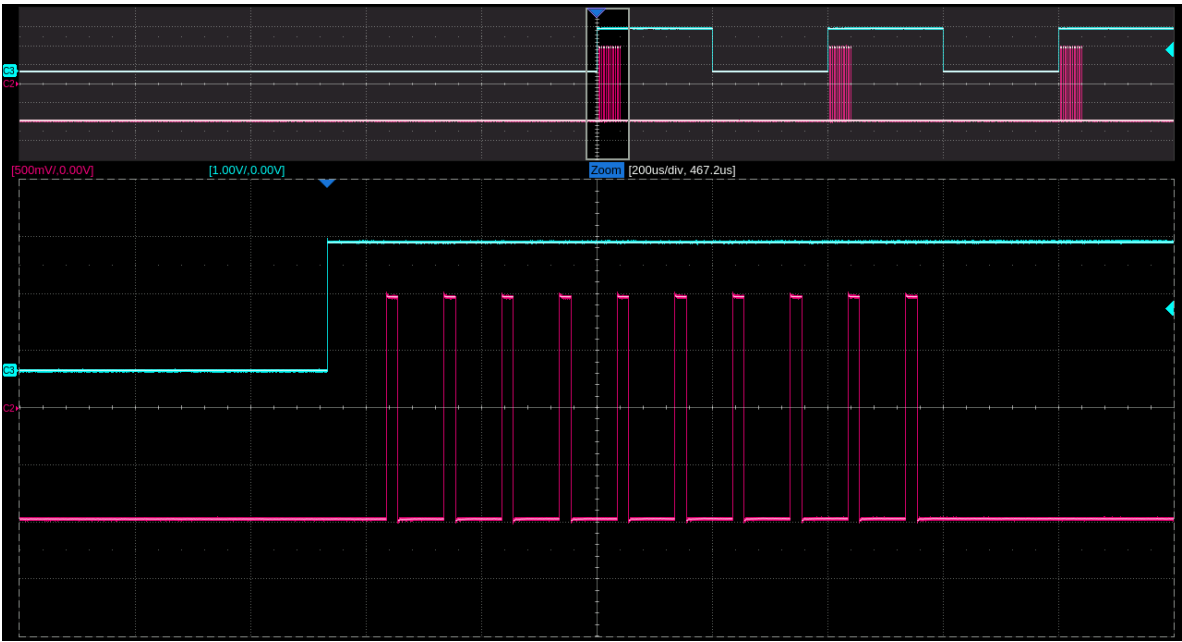

15 Hopping

Frequency hopping only supports AM modulation with sine or sine carrier.

Click on the Hopping in the toolbar on the home page to access the relevant settings. Similar to sequence, the frequency hopping function is divided into two steps: function opening and frequency hopping output. When the frequency hopping function is opened, the sweep, burst and other functions are automatically closed, and the basic wave is automatically switched to sine (when the current channel carrier is not sine), and the normal output is stopped. After editing the frequency hopping parameters, turn on the frequency hopping output and output the frequency hopping signal.

There are three modes of manual, random hop and random list. Different modes can be switched through the "Type" menu. According to different frequency hopping types, there are three lists to set. The set list can be saved to a file for next call.

See the following table for details:

Table 15-1 Types of hopping

Hopping type	Description
manual	Output the frequency points set in the frequency lists according to the customized order list
random hop	According to the selected PRBS code type, output each frequency point of the frequency lists automatically generated by the set frequency step in the maximum and minimum frequency range
random list	Output the frequency point set in the frequency list according to the selected PRBS code type

15.1 Manual

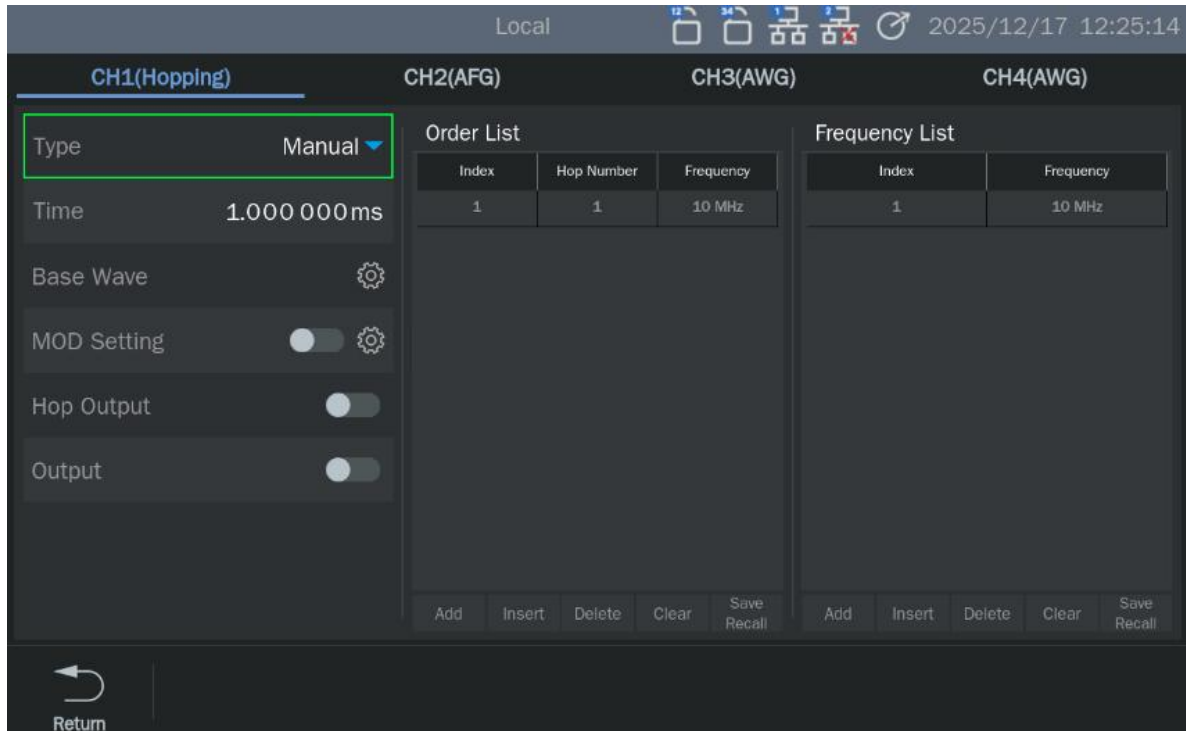

Table 15-2 Manual Parameters Description

Parameters	Description
Time	Set frequency hopping interval
Fundamental wave setting	Set parameters such as load, amplitude and offset of Sine wave.
MOD setting	Set parameters such as modulation source, modulation frequency, modulation depth and modulation waveform.
Frequency list	Set the frequency of each frequency point
Order list	Set the order of frequency point output in the frequency list

Table 15-3 Description of frequency list

Function	Description
Add	Add a frequency point at the end of the frequency list.
Insert	Adding a frequency point in front of the selected frequency point in the frequency list.
Delete	Delete the last frequency point or delete the selected frequency point
Clear	Clear all new frequency points and restore the default items.
Save/Recall	Save the hop file configured in the current table or call the saved hop file.

Table 15-4 Order list description

Function	Description
Add	Add a frequency point at the end of the order list.
Insert	Adding a frequency point in front of the selected frequency point in the order list.
Delete	Delete the last frequency point or delete the selected frequency point
Clear	Clear all new frequency points and restore the default items.
Save/Recall	Save the hop file configured in the current table or call the saved hop file.

15.2 Random Hop

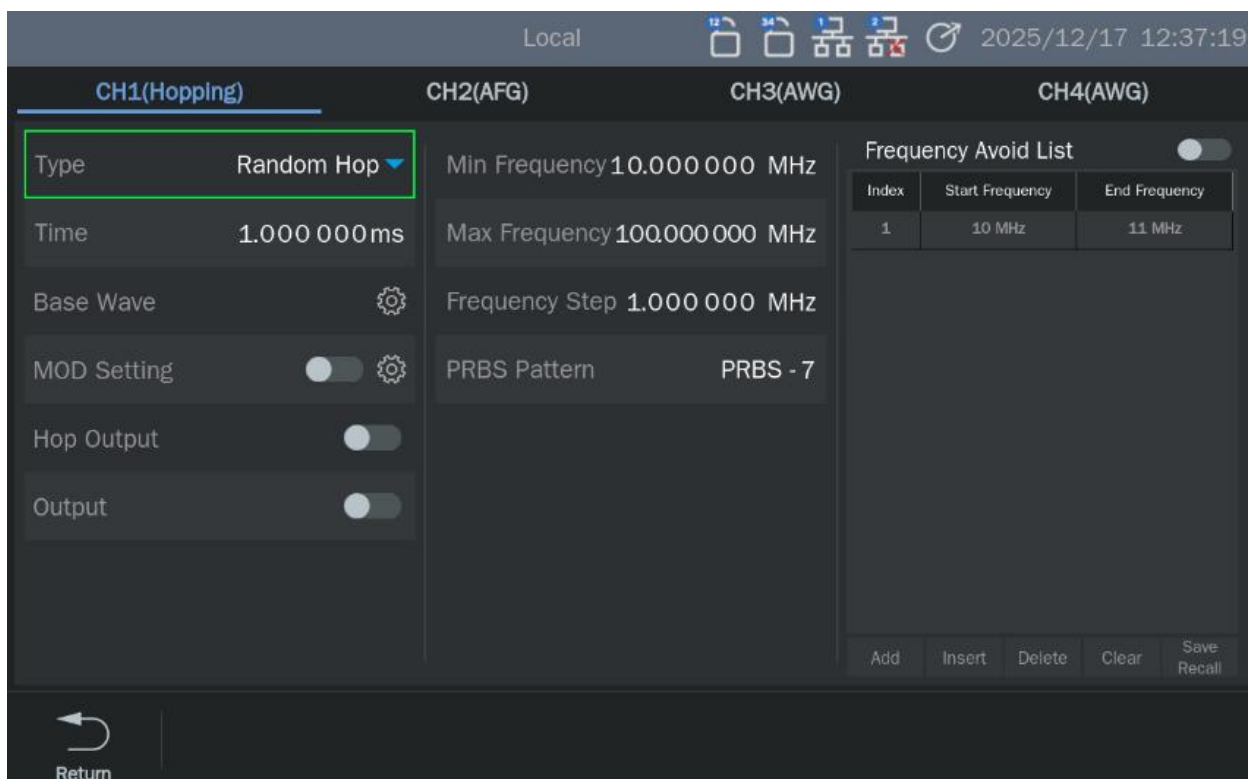

Table 15-5 Random hop parameter description

Parameters	Description
Frequency avoid list	Set and enable the frequency filter table to filter out unwanted frequency bands
Time	Set the time for each frequency point
Min frequency	Set the minimum frequency of randomly generated frequency list
Max frequency	Set the maximum frequency of randomly generated frequency list

Frequency step	Set the frequency interval of randomly generated frequency list
PRBS	Set hop output order
Frequency avoid list	Set and enable the frequency filter table to filter out unwanted frequency bands

Table 15-6 Description of frequency avoid list

Function	Description
Add	Add a frequency point at the end of the frequency avoid list.
Insert	Adding a frequency point in front of the selected frequency point in the frequency avoid list.
Delete	Delete the last frequency point or delete the selected frequency
Clear	Clear all new frequency points and restore the default items.
Save/Recall	Save the hop file configured in the current table or call the saved hop file.

15.3 Random List

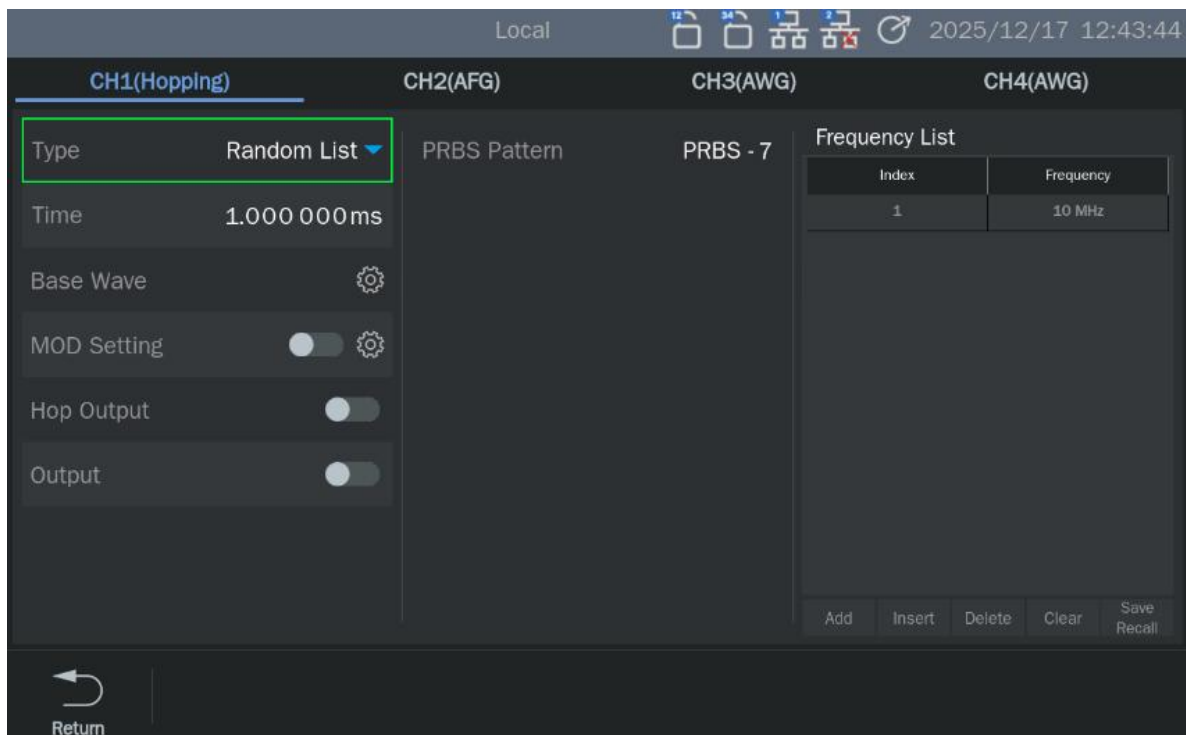

Table 15-7 Random list parameter description

Parameters	Description
Time	Set frequency hopping interval

Fundamental wave setting	Set parameters such as load, amplitude and offset of Sine wave.
MOD setting	Set parameters such as modulation source, modulation frequency, modulation depth and modulation waveform.
PRBS	Set hop output order

16 Multitone

According to the sampling rate and multi-tone list, multi-tone signals are generated and output through AWG.

Execute `tools` > `multitoned` to enter the multitone parameter setting page.

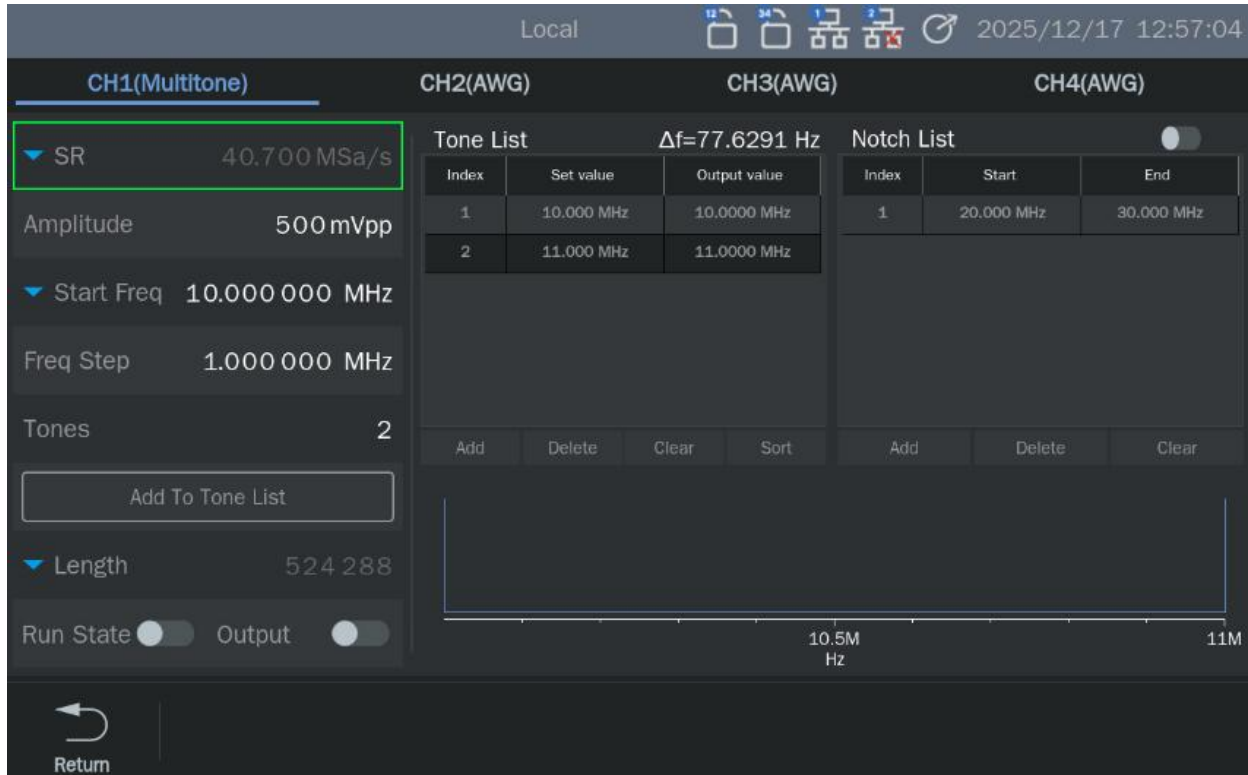

Table 16-1 Multi-tone parameter description

Parameters	Description
Sampling rate	Automatic: the sampling rate is Sa/s, and the setting range is 100 sa/s ~ 5 GSa/s. The automatic setting value is 3.7 times the maximum setting frequency of Tone List.
	Custom: the sampling rate is Sa/s, and the setting range is 100 sa/s ~ 5 GSA/s. The setting value should be greater than or equal to 2.5 times the maximum setting frequency of Tone List.
Amplitude	The setting range is consistent with the settable range of output mode 50 Ω load. See the data sheet for details.
Start Freq	Sets the starting frequency of generating Tone List frequency points.
Freq Step	Sets the frequency step for generating Tone List frequency points.
Tones	Set the number of generated multi-tone points, and use them together with the starting frequency and frequency stepping to generate a Tone List.

CFreq	Set the center frequency of multi-tone signal.
Freq Interval	Set the frequency interval for generating multi-tone signals.
Tones(single side)	Set the number of generated multi-tone points, and use it together with the center frequency and frequency interval to generate Tone List.
Add To Tone List	This button is used to add frequency points to the Tone List according to the starting frequency, frequency step and tone number or according to the center frequency, frequency interval and tone number (unilateral); Adding frequency points does not consider the limitation of Notch List.
Length	Automatic: The sampling rate is divided by the greatest common divisor of all multi-tone points, and the nearest 2^N value is the automatically set waveform length.
	Custom: the setting value can only be 2^N . If the setting is not 2^N , the closest 2^N value will be selected.
Tone List	Multi-tone list, which can be sorted according to the frequency of frequency points from small to large, manually added and deleted, and the list can be cleared to the default frequency points.
Notch List	Frequency point filter table, which sets the frequency point range of Tone List to be filtered, and can be manually added, deleted and cleared to the default range; The frequency filter table is limited by the actual output frequency.

Table 16-2 Notch List parameter description

Parameter	Description
Add	Add a frequency range at the end of Notch List.
Delete	Delete the last frequency range or selected frequency range.
Clear	Clear all frequency ranges and restore the default items.

Table 16-3 Tone List parameter description

Parameter	Description
Add	Add a frequency point at the end of Tone List.
Delete	Delete the last frequency point or selected frequency point.
Clear	Clear all frequency point and restore the default items.
Sort	Sort all the frequency points from small to large.

17 Chirp

Chirp generates a waveform with linear frequency change according to the sampling rate and frequency modulation list, and outputs it through AWG. When the starting frequency is less than the ending frequency, the signal frequency changes gradually from small to large. When the starting frequency is greater than the ending frequency, the signal frequency gradually changes from large to small.

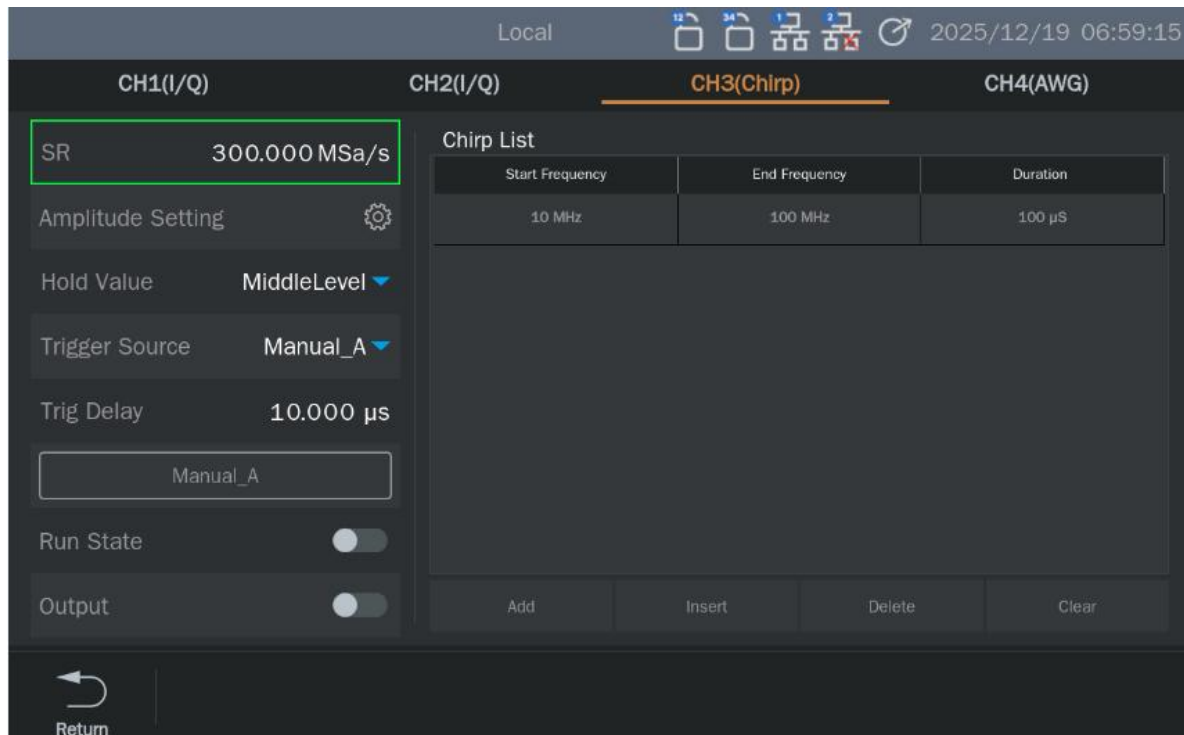

Table 17-1 Chirp parameter description

Parameter	Description	
Sampling rate	The unit of sampling rate is Sa/s, and the setting range is 100 sa/s ~ 5 GSa/s. The setting value should be greater than 2.5 times the maximum frequency of chirp.	
Amplitude setting	Amplitude	Set the output amplitude of chirp.
	Offset	Set the output offset of chirp.
	Load	The output load can be selected as 50 Ω, Hiz and custom.
Hold Value	There are three idle levels of chirp: low level, middle level and high level.	
Trigger Source	Set the trigger mode of chirp, including internal, manual trigger A/B, external trigger 1/2 and timer.	
Trig Delay	Set the delay time of chirp output (timer trigger does not have this parameter)	

Trig Timer	Timer trigger source can be set.
Ext_Edge	Set the edge triggered by external trigger signal, including rising edge, falling edge and upper and lower edge.
Start Frequency	Set the start frequency of chirp current segment.
End Frequency	Set the end frequency of chirp current segment.
Duration	Sets the time when the start frequency of the current segment changes linearly to the end frequency.

18 Multi Pulse

The multi-pulse function is output in AWG mode. After editing the multi-pulse parameters, turn on the channel output and run to output multi-pulse waves.

Execute `tools` > `multi pulse` to enter the multi-pulse parameter setting page.

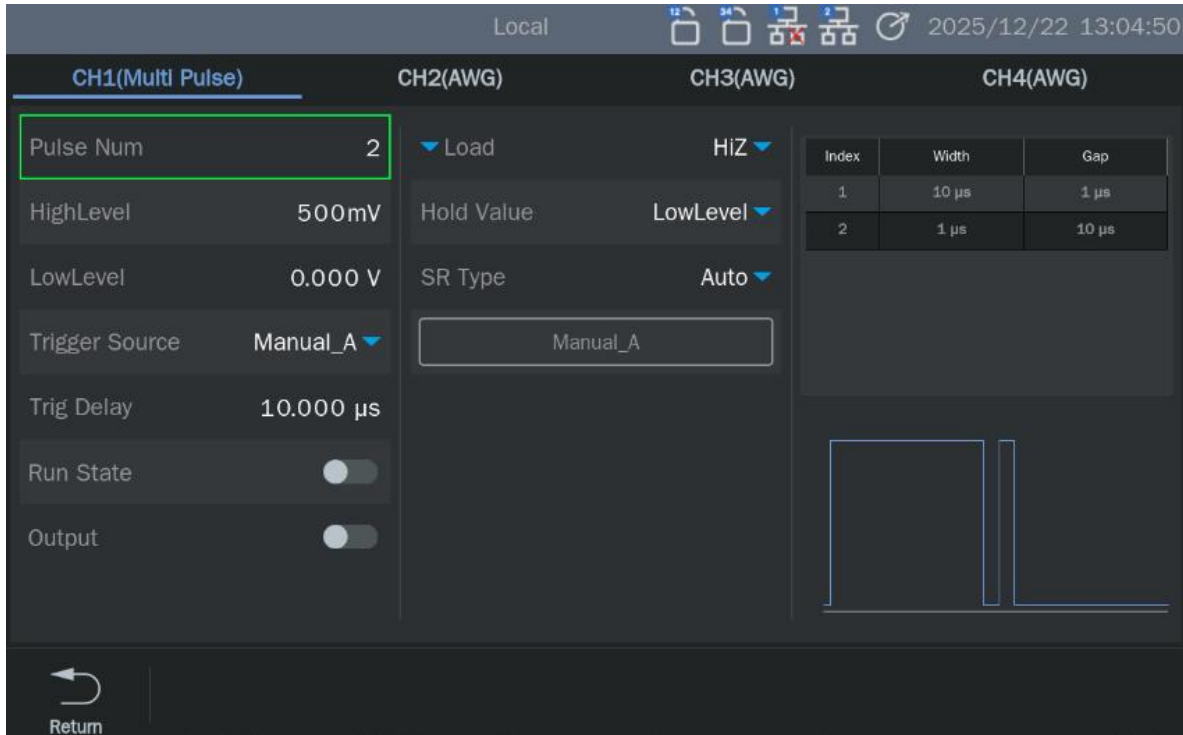

Table 18-1 Multi-pulse parameter description

Parameter	Description
Pulse Num	Set the number of output pulses.
HighLevel	Set the high level of the output pulse.
LowLevel	Set the low level of the output pulse.
Trigger Source	Set multi-pulse trigger mode, which can set internal and manual trigger A/B, external trigger 1/2 and timer.
Trig Delay	Used to set the delay time of multi-pulse output (timer trigger does not have this parameter).
Trig Timer	Set the timing time under the timer trigger source.
Ext_Edge	Set the edge triggered by external trigger signal, including rising edge, falling edge and upper and lower edge.
Load	The output load of multi-pulse can be selected as 50 Ω, HiZ and custom.
Hold Value	There are four settings for the level when no pulse is output: low level, middle

	level, high level and zero level.
SR Type	Automatic and customized types can be set, and the sampling rate can be set from 100 Sa/s to 5 GSa/s when customized.
Width	Set the width of the positive pulse of the output pulse.
Gap	Set the width of the negative pulse of the output pulse.

19 HSS

AWG supports a variety of data modes, high-speed signal generation with a maximum data rate of 2.5 Gbps, rich settings such as invert bits, 8b/10b coding, NRZ coding, PAM modulation, etc., to meet various scene signal requirements.

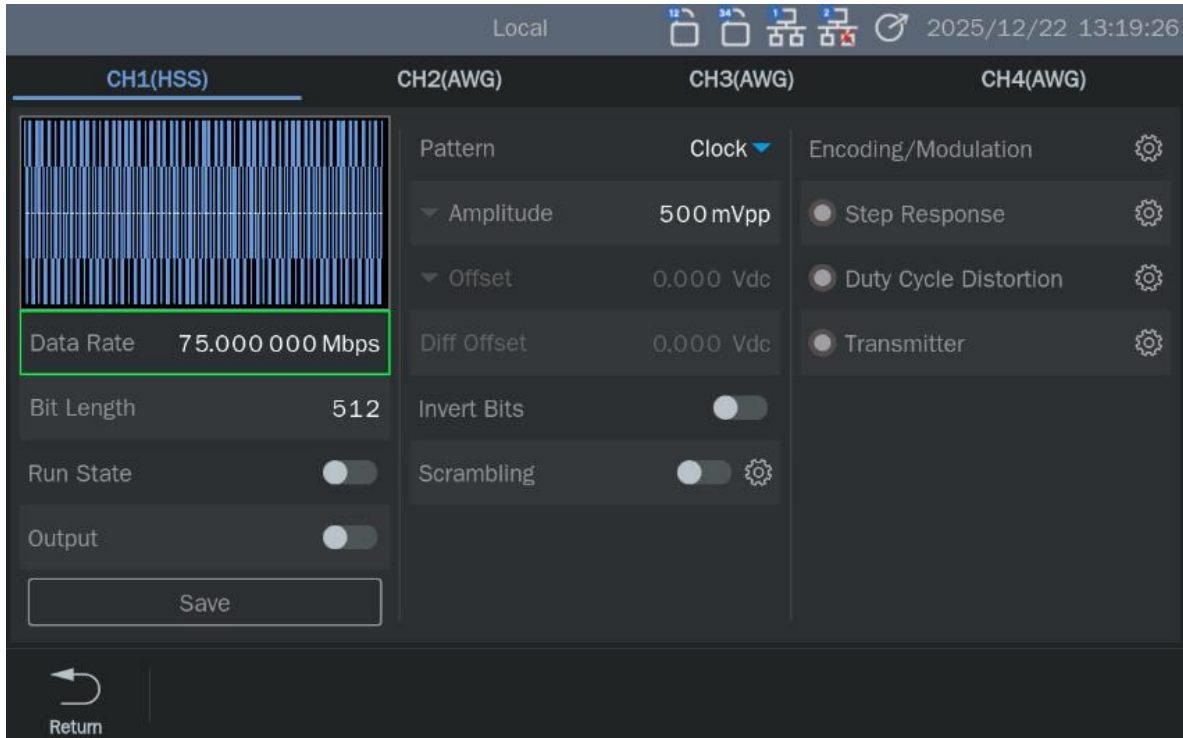

Table 19-1 Hss parameter description

Parameter	Description
Data Rate	Set the data rate of the signal, 500 kbps to 2.5 Gbps.
Save	Save the current Hss as a bin format waveform file, which can be loaded and called under AWG.
Amplitude	Set the output amplitude of hss signal.
Offset	Set the offset of hss signal, DC-HBW mode cannot be set.
Diff Offset	Set the differential offset of hss signal, only the DC-AMP mode can be set.
Bit Length	Set the data length of the signal.
Pattern	Six data modes can be set: clock mode, all zero mode, all one mode, PRBS mode, custom PRBS and custom.
PRBS Length	When the data mode is PRBS mode, the PRBS length can be set from 3 to 32.
Invert Bits	On, the data bit is invert.

Scrambling	The scrambling polynomial and scrambling mode (addition and multiplication) can be customized.
8b/10b	RD- and RD+ can be set to optimize data DC equalization; RD-: indicates that the number of "1" is 2 more than that of "0"; RD+: indicates that the number of "0" is 2 more than the number of "1".
Encoding/Modulation	There are two codes, NRZ and NRZ-I, and three modulation modes, PAM-4, PAM-8 and PAM-16, can be set.
PWM	Setting the code to NRZ or NRZ-I can set the pulse width of PWM modulation.
Step Response	Set the time, mode and range of rising and falling edges of signals.
Duty Cycle Distortion	Set the duty cycle distortion of the signal.
Transmitter	Set jitter, noise, equalization and spread spectrum clocks.
Periodic Jitter	Set periodic jitter parameters, jitter range, phase and frequency.
Random Jitter	Set random jitter parameters, jitter range, bandwidth and peak-to-average ratio.
Noise Setting	Set the amplitude, bandwidth and PAPR of noise superposition.
Equalization	Set the equalization parameters of the signal. Equalization uses FIR filter, which supports 5 taps.
SSC Setting	Setting the spread spectrum clock can effectively reduce the EMI. Support the setting of sine, square and triangle modulation waveforms, and set the frequency and deviation of modulation waveforms.

20 Output Setting

The waveform of each channel can be processed before Output, including polarity inversion, superimposed noise, digital filtering, amplitude limitation, analog filter switching, overvoltage protection, output mode switching, output delay setting and marker setting.

Click *Output Setting* in the toolbar on the homepage to enter the related settings page.



Table 20-1 Output setting function menu description

Function menu	Set	Description
Noise Sum	Default off	You can choose to superimpose random noise on the signal and output it to simulate the real scene where the signal is polluted by noise.
	SNR	The unit is ratio (dimensionless) or dB.
Polarity Reversal	Off	Set the waveform general output.
	On	Set waveform inverting output
Max Ampl	Default is the maximum output amplitude of the current mode.	In some application scenarios, users need to limit the amplitude of channel output to ensure that amplitude-sensitive signal receiving equipment will not be damaged. The set value is calculated in Hz.
Digital Filter	Default off	A digital filter is integrated in each channel of the device

		to support low-pass filtering of output data, and the cut-off frequency of the filter can be set. In this way, users can limit the bandwidth of output signals according to their own needs.
Analog Filter	AFG/AWG defaults to 2G; IQ default 5G	Gateable analog filter, which cannot be bypassed, is used to filter out the mirror frequency component of DAC duty cycle in AFG mode.
CH OVP	Default on	Each channel is controlled independently. If the threshold voltage is exceeded, the channel output will be automatically turned off.
Output Mode	Default DC-HBW	There are four modes: DC-HBW, DC-AMP, AC-DIR and AC-AMP. The response and parameters of different modes are different. See the product data sheet for details.
Output Skew	Default 0	Each channel can be set independently, and the adjustment range is ± 500 ns. Used to adjust the skew between channels.
Marker Setting	Default off	Sweep, AWG and IQ need to turn on the switch of marker setting, and set the marker output amplitude, offset and time delay as needed.
	Amplitude defaults to 1 Vpp.	
	Offset defaults to 0.	
	Skew default 0	

21 Multi-Channel

21.1 Channel Mode

Four-channel models support setting two channel modes: "Pair Mode" and "All Mode". In the "Pair Mode", CH1&CH2 and CH3&CH4 are paired, and the phase mode and coupling relationship can be set independently. "All Mode" requires four channels to be in the same playback mode (AFG, AWG, IQ).

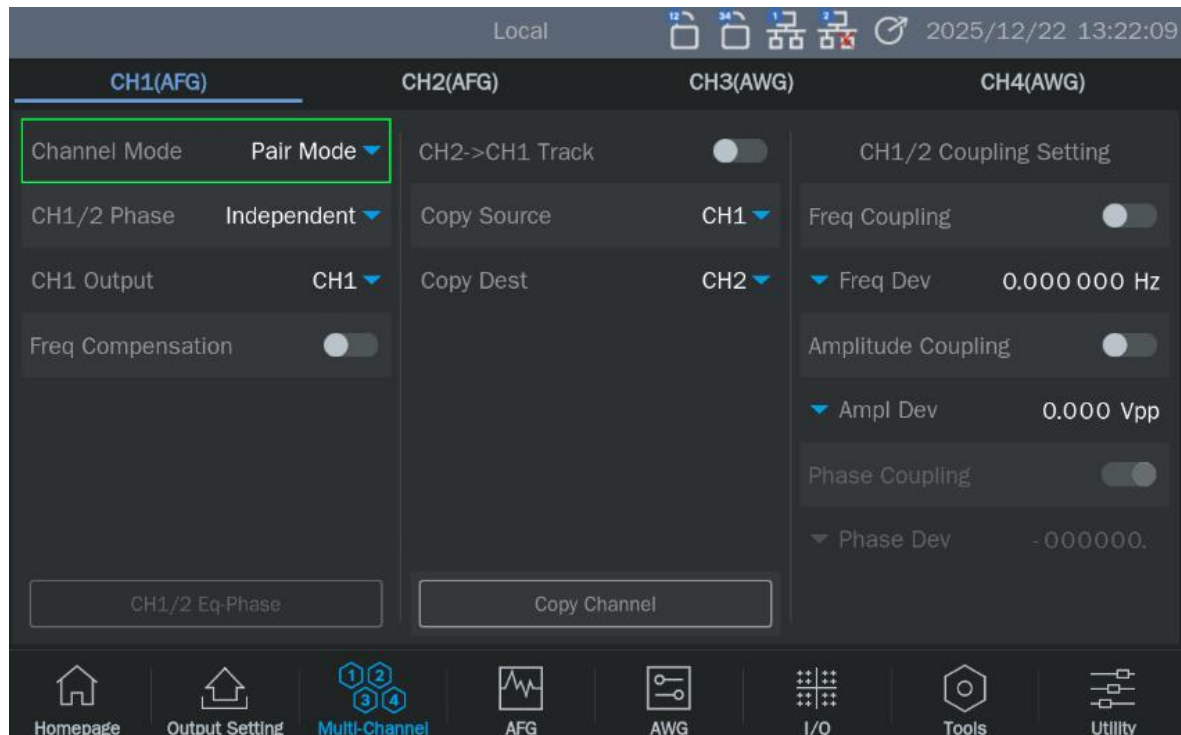

Note: Only four-channel models can be set, and two-channel models do not have this setting item.

21.2 Phase Mode

The phase mode can only be set in AFG mode. When the channel mode is "Pair Mode", CH1/2 (or CH3/4) phase independence or phase locking can be set. When the channel mode is "All Mode", all channels (CH1/2/3/4) can be set to be phase independent or phase locked.

Locked

When the frequency is changed, the DDS of both channels will be reset, and the phase difference between multiple channels will remain unchanged, and the output will be synchronized.

Independent

When changing the frequency, the DDS of the two channels will not be reset, and the phase difference

between the channels will change randomly. It is forbidden to set phase parameters,

The *phase* menu will not be displayed.

21.3 Channel Combine

Channel merging can combine the two channels' waveforms and output them. It has good real-time performance and can superimpose noise, modulated signal, swept frequency signal, Burst signal, EasyPulse waveform and Arb waveform, which provides users with a new means to accurately generate complex waveforms.

When entering the multi-channel setting interface of the target channel, you can set the output combined waveform. For example, when entering the multi-channel setting interface of CH1 (AFG), you can click the inverted triangle icon  of *CH1 Output* to select the single-ended or combined waveform of this channel.

Channel 1 can choose to output the waveform of CH1 or the waveform of CH1+CH2;

Channel 2 can choose to output the waveform of CH2 or the waveform of CH1+CH2;

Channel 3 can choose to output the waveform of CH3 or the waveform of CH3+CH4;

Channel 4 can choose to output the waveform of CH4 or the waveform of CH3+CH4.

You can also directly select and click the corresponding selector on the block diagram of the home page to set the waveform of the output single channel or the merged waveform, as shown in the following figure:

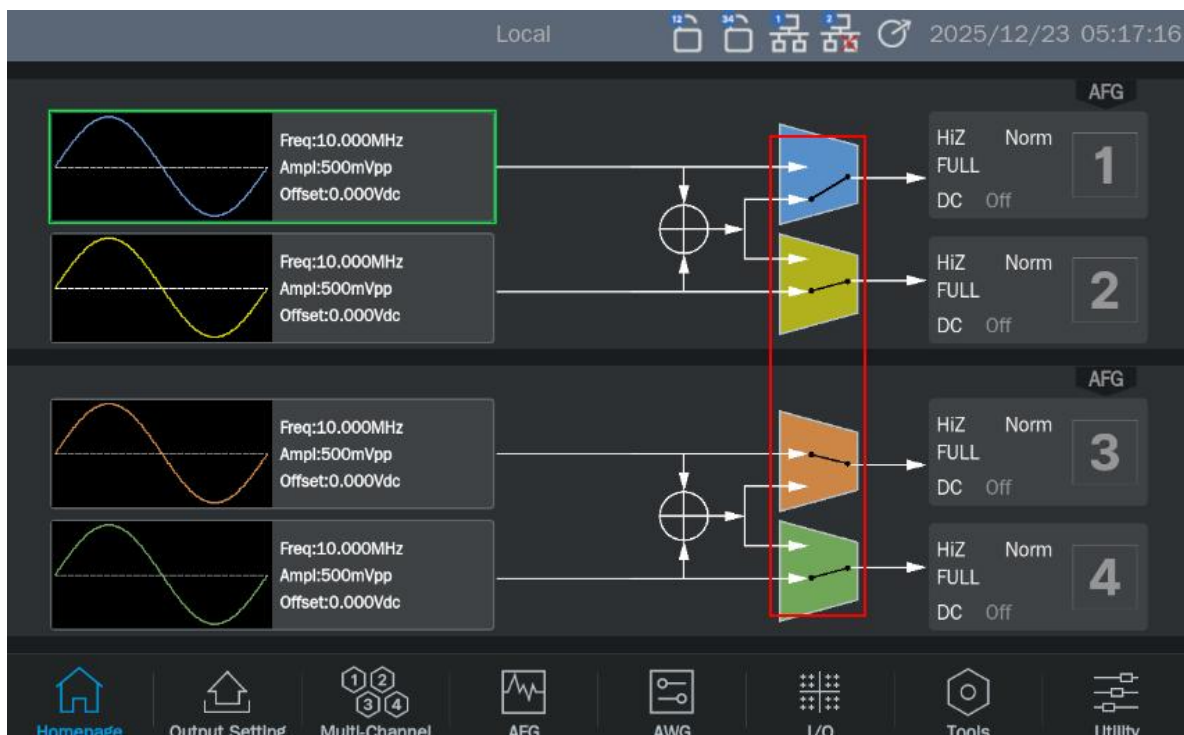

Note: Only supported in AFG mode.

21.4 Eq-Phase

AFG mode phase locking, *multi-channel* > CH1/2 Eq-phase or CH3/4 Eq-phase or

Eq-phase quick setting: Two or four channels have the same phase, based on CH1 or CH3 (four-channel All Mode).

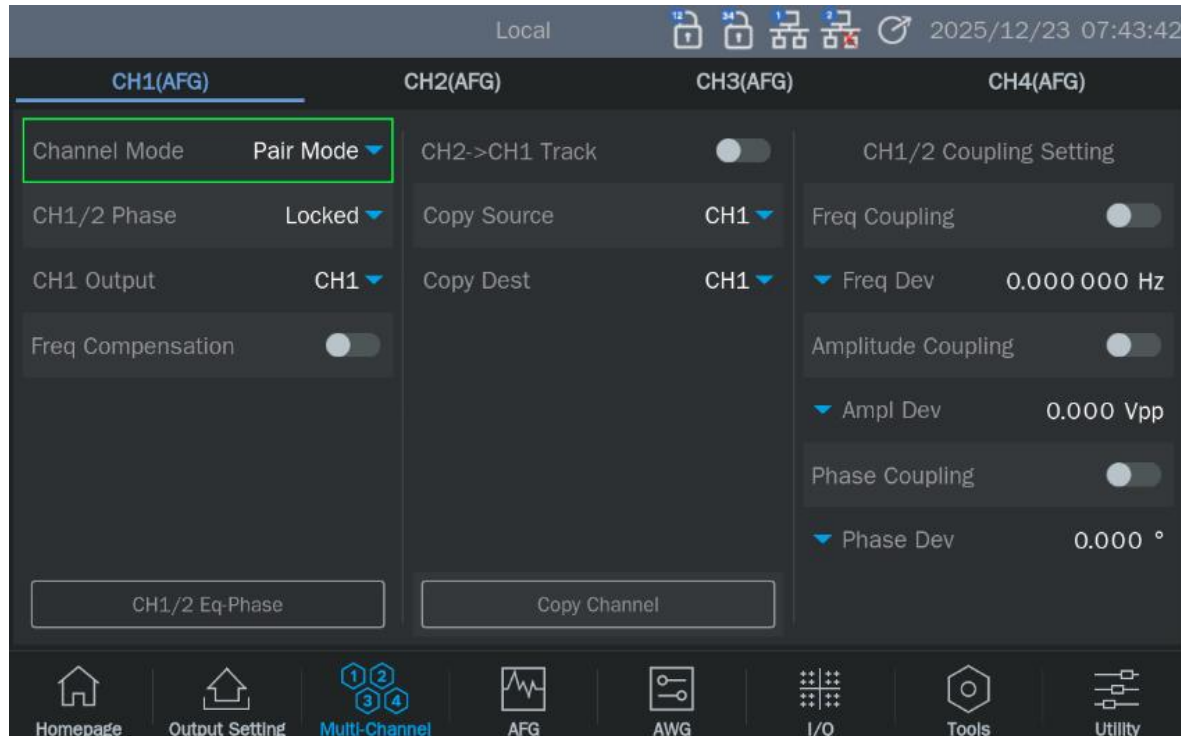

21.5 Channel Track

When the tracking function is turned on, adjust the parameters of CH1, and the corresponding parameters of the tracked channel will be automatically adjusted to the same parameters or status as CH1.

You can turn the tracing function on or off by executing *Multi-Channel* > *Track*. When the tracking function is turned on, the channel copy and coupling functions cannot be used, and the channel interface can only be switched to CH1.

Phase deviation: the phase deviation between the tracking channel and the reference channel. For example, the parameter relationship is: $\text{Phase}_{\text{CH2}} - \text{Phase}_{\text{CH1}} = \text{PhaseDev}$.

Select *PhaseDev*, enter the phase deviation setting interface, and then use the numeric keypad or arrow keys and knobs to enter the required value.

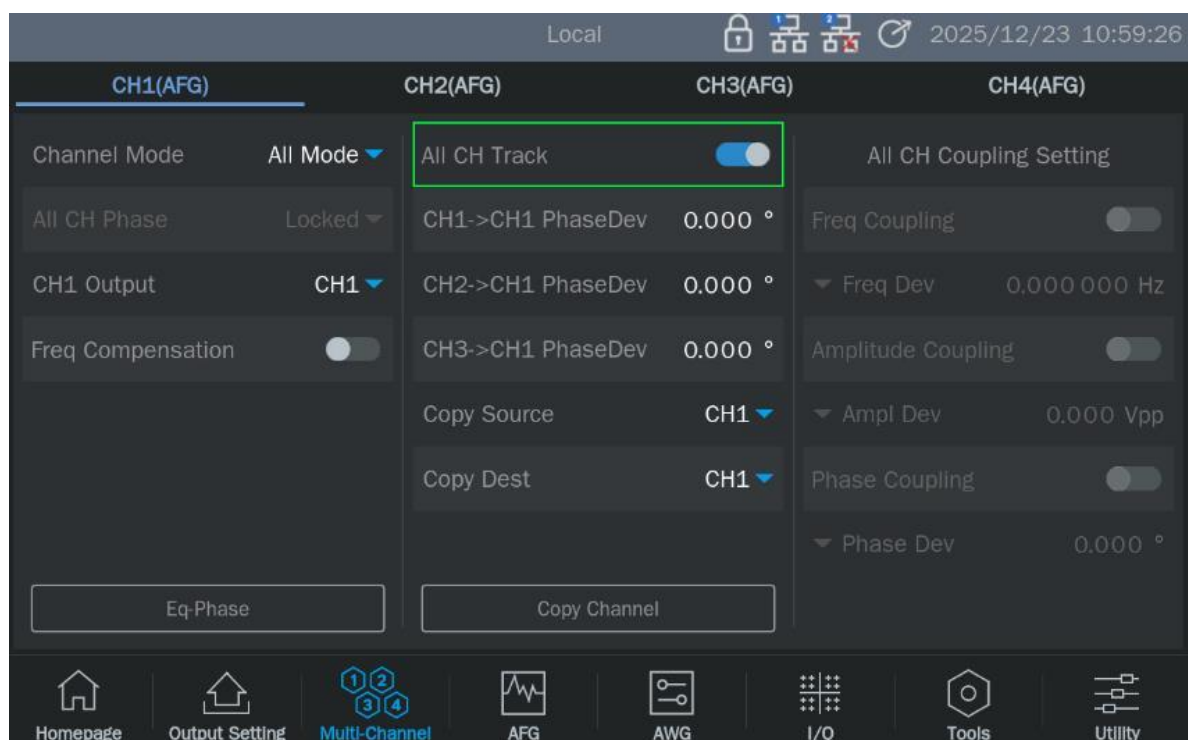
**Note:**

- 1) Four-channel models need four channels to use the tracking function, which needs to be used in All Mode.
- 2) Only when tracking is turned on in AFG mode will there be phase deviation.
- 3) All Mode is on tracking, and the phase deviation is based on CH1; In the Pair Mode, it is based on CH1 or CH3.

21.6 Channel Copy

The device supports the function of copying the states, parameters and waveforms between two channels, that is, copying all the parameter settings and states of one channel to the other channel.

Perform *Multi-Channel* setting and enter the channel copy setting interface.

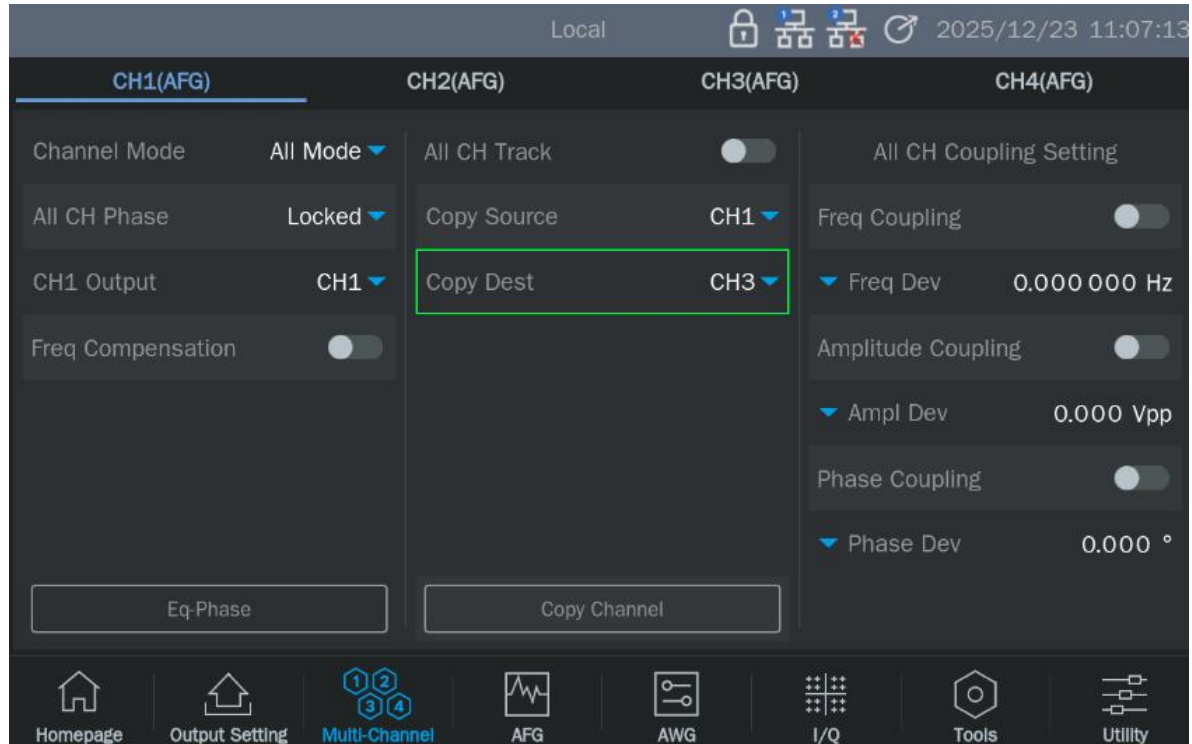

Table 21-1 Channel copy menu description

Function menu	Description
Copy Source	Set the copied source channel, which can be selected as CH1, CH2, CH3 and CH4.
Copy Desst	Set the copied target channel, which can be selected as CH1, CH2, CH3 and CH4.
Copy Channel	Perform channel copy as set.

Note:

- 1) The coupling and tracking functions are mutually exclusive with the channel copy function. When the channel coupling or tracking function is turned on, the channel copy function cannot be set.
- 2) When the inter-channel playback modes (AFG, AWG, IQ) are different, the copy function cannot be performed.

21.7 Channel Coupling

The device supports the coupling of frequency, amplitude and phase.

The frequency deviation/frequency ratio, amplitude deviation/amplitude ratio or phase deviation/phase ratio between CH2/3/4 and CH1 can be set in the all-channel mode of the four-channel model; The two-channel mode can set the frequency deviation/frequency ratio, amplitude deviation/amplitude ratio or phase deviation/phase ratio of two channels (CH1 and CH2, CH3 and CH4). When the coupling function is turned on, CH1 and CH2 are mutual reference sources. When the frequency, amplitude or phase of one channel (which is used as the reference source) is changed, the frequency, amplitude or phase of the other channel will be automatically adjusted and always keep the specified deviation/proportion with the reference channel.

Note:

The reference channel is CH1 or CH3 (four-channel model Pair mode).

Perform `multi-channel` setting to enter the channel coupling setting interface.

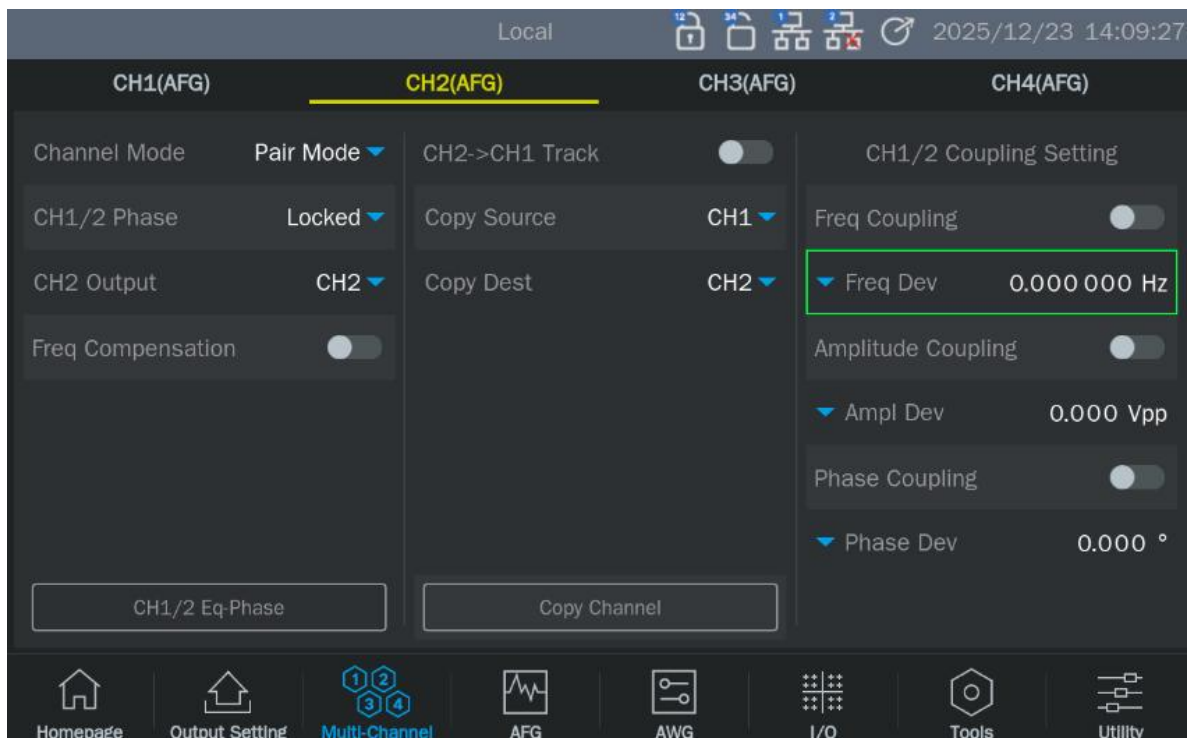

Freq Coupling

Turn on frequency coupling

Press `freq coupling` to turn the frequency coupling function on or off. The default is "Off".

Frequency mode

By pressing the inverse triangle  of *Freq Dev*, you can switch between Frequency Deviation and Frequency Proportion, and then use the numeric keypad or knob to enter the required value.

- Frequency ratio: frequency ratio relative to the reference channel. For example, the parameter relationship is: $\text{Freq}_{\text{CH2}}:\text{Freq}_{\text{CH1}}=\text{FreqRatio}$
- Frequency deviation: the frequency deviation from the reference channel. For example, the parameter relationship is: $\text{Freq}_{\text{CH2}}-\text{Freq}_{\text{CH1}}=\text{FreqDev}$

Amplitude coupling

Turn on amplitude coupling

Press *amplitude coupling* to turn the amplitude coupling function on or off. The default is "Off".

Amplitude mode

Press the inverse triangle  of *Ampl Dev* to switch between "amplitude deviation" and "amplitude proportion", and then use the numeric keypad or knob to enter the required value.

- Amplitude ratio: the amplitude ratio relative to the reference channel. For example, the parameter relationship is: $\text{Ampl}_{\text{CH2}}:\text{Ampl}_{\text{CH1}}=\text{AmplRatio}$
- Amplitude deviation: the amplitude deviation from the reference channel. For example, the parameter relationship is: $\text{Ampl}_{\text{CH2}}-\text{Ampl}_{\text{CH1}}=\text{AmplDev}$

Phase coupling

Turn on phase coupling

Press *Phase Coupling* to turn the phase coupling function on or off. The default is "Off".

Phase coupling (used in phase locking mode)

Press the inverted triangle  of *phase coupling*, you can switch between "phase deviation" and "phase proportion", and then use the numeric keypad or knob to enter the required value.

- Phase ratio: the phase ratio relative to the reference channel. For example, the parameter relationship is: $\text{Phase}_{\text{CH2}}:\text{Phase}_{\text{CH1}}=\text{PhaseRatio}$
- Phase deviation: the phase deviation from the reference channel. For example, the parameter relationship is: $\text{Phase}_{\text{CH2}}-\text{Phase}_{\text{CH1}}=\text{PhaseDev}$

Note:

- 1) The coupling function is only effective when two or four channels are in AFG (Sine, Square, Ramp,

Pulse or Arb) mode.

- 2) When the phase coupling function is turned on, modify the phase of one channel, and the phase of the other channel will change accordingly. At this time, the two channels can be truly in phase without performing the in-phase function.



22 Utility

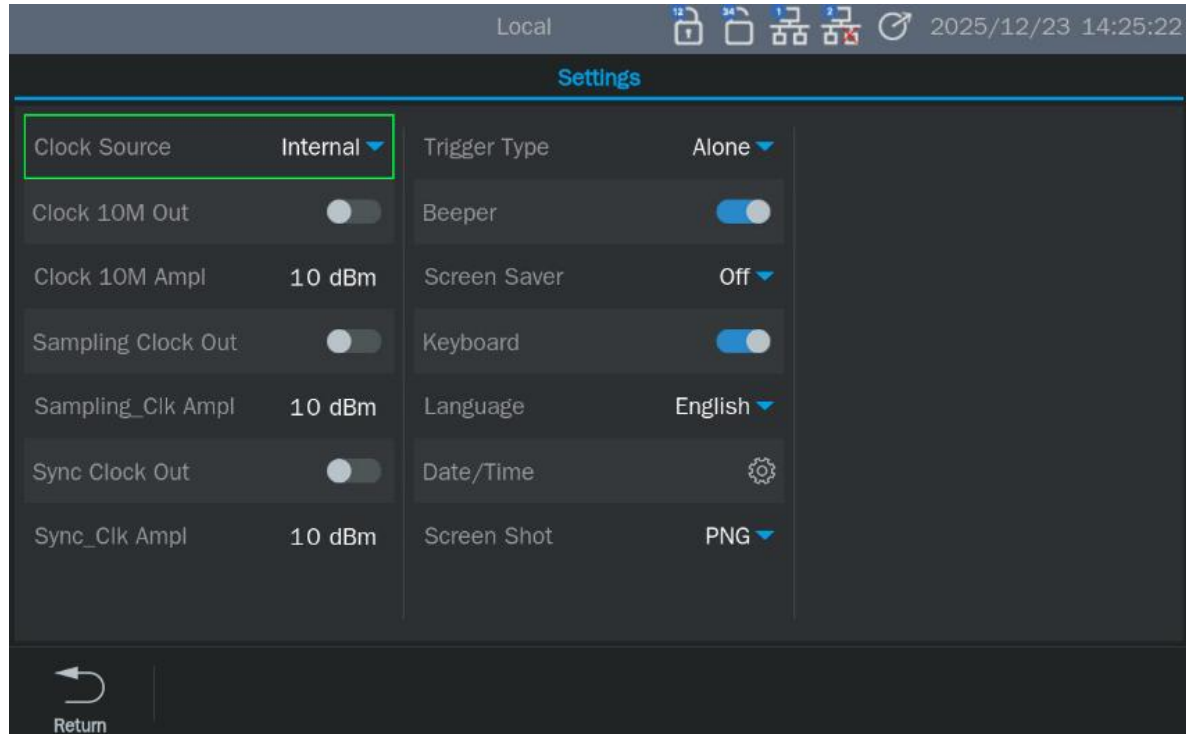

22.1 Setting



22.1.1 Clock Source

The device provides an internal 10 MHz clock source, receives an external clock source input from **【10M Ref Clock In】** on the back panel of the device, and also receives an external clock source input from **【Sample Clock In】** on the back panel of the device.

Select **Utility** > **settings** > **clock source**, and select internal, external or Ext_Sampling. "Internal" is selected by default, and the icon  displayed on the top menu bar. If "external" is selected, the system will check whether there is a valid external clock signal input at the **【10M Ref Clock In】** interface on the back panel of the equipment. If a valid external clock source is not detected, a prompt message "No available external clock detected" will pop up. the clock source is displayed as "External", and the icon  on the top menu bar. If a signal is detected, the icon  displayed on the top menu bar.

If "Ext_Sampling" is selected, the system will check whether there is a valid external clock signal input at the **【Sample Clock In】** connector on the back panel of the equipment. If a valid external clock source is not detected, a prompt message "No available external clock source detected" will pop up. the clock source is displayed as "Ext_Sampling", and the icon  on the top menu bar. If a signal is detected, the icon  displayed in the top menu bar.

22.1.2 Set Clock Output

The equipment can output 10 MHz signals from the 【10M Ref Clock Out】 connector on the back panel; Output the external sampling clock signal from the 【Sample Clock Out】 connector (when the clock source uses the Ext_Sampling); The synchronous clock signal is output from the 【Sync Clock Out】 connector, and the frequency of the synchronous signal is 312.5 MHz at 5G sampling clock and 250 MHz at 6 G sampling clock. The output amplitude of the three clock signals can be adjusted, ranging from 3 dBm to 10 dBm.

22.1.3 Set Trigger Type

Perform **Utility** > **Settings** > **Trigger Type**, you can set single trigger(Alone) and trigger together(All).

Table 22-1 Channel trigger type description

Function menu	Description
Alone	Clicking on the manual_A/B menu on the screen will only trigger the output of the currently selected channel.
All	Clicking on the manual_A/B menu on the screen will trigger all channel outputs.

Note

This function only takes effect when **manual_A/B** on the screen. Setting “Alone” to press the **TrigA/B** on the front panel will also trigger all channel outputs.

22.1.4 Set Buzzer

Execute **Utility** > **settings** > **Beeper**, set on/off.

22.1.5 Set Screen Saver

When the device enters an idle state and remains idle for a certain period of time, the screen saver will be enabled. The screensaver will turn off the backlight of the display screen after the specified time arrives to save the power consumption of the display screen.

You can specify the idle time by executing **Utility** > **Settings** > **Screen Saver**. Optional screen saver idle time is: 1 minute, 5 minutes, 15 minutes, 30 minutes and 1 hour. You can also choose Close to disable the screen saver.

After the screen saver takes effect, touching the screen, pressing the key, turning the knob or moving the mouse can make the device exit the screen saver.

22.1.6 Key Switch

You can set the front panel key switch.

Execute **Utility** > *settings* > *keyboard* , and click.

22.1.7 Language

The operation interface supports simplified Chinese and English.

Execute **Utility** > *settings* > *Language* , and select the language from the pop-up list.

22.1.8 Date/Time

This device allows you to choose to set the time and date manually.

Execute **Utility** > *settings* > *Date/Time* to set the system time displayed by the signal source.

22.1.9 Screen Shot

The device supports holding the knob on the front panel for about 2 seconds to save the current display interface, and supports saving pictures in PNG and BMP formats. When the device is inserted into the USB flash drive, the screenshot file will be saved in the root directory of the USB flash drive first. If the USB flash drive is not inserted, it will be saved in the Local path by default.

22.2 Save And Recall

The device supports storing and calling setting files, waveform files and firmware upgrade files. The storage and calling locations include internal storage (Local), external USB storage devices (such as U disk) or network storage (net_storage). Store and call operations are implemented through the file manager.

- You can use the knob to switch between Local, USB Device and network storage (net_storage), or directly click the corresponding position on the screen to select, select, press the knob or click the selected folder to expand the current storage directory.

- Use the knob to switch files or folders in the current directory or directly click the corresponding position on the screen to select, and then select the operation to be performed in the menu button below.

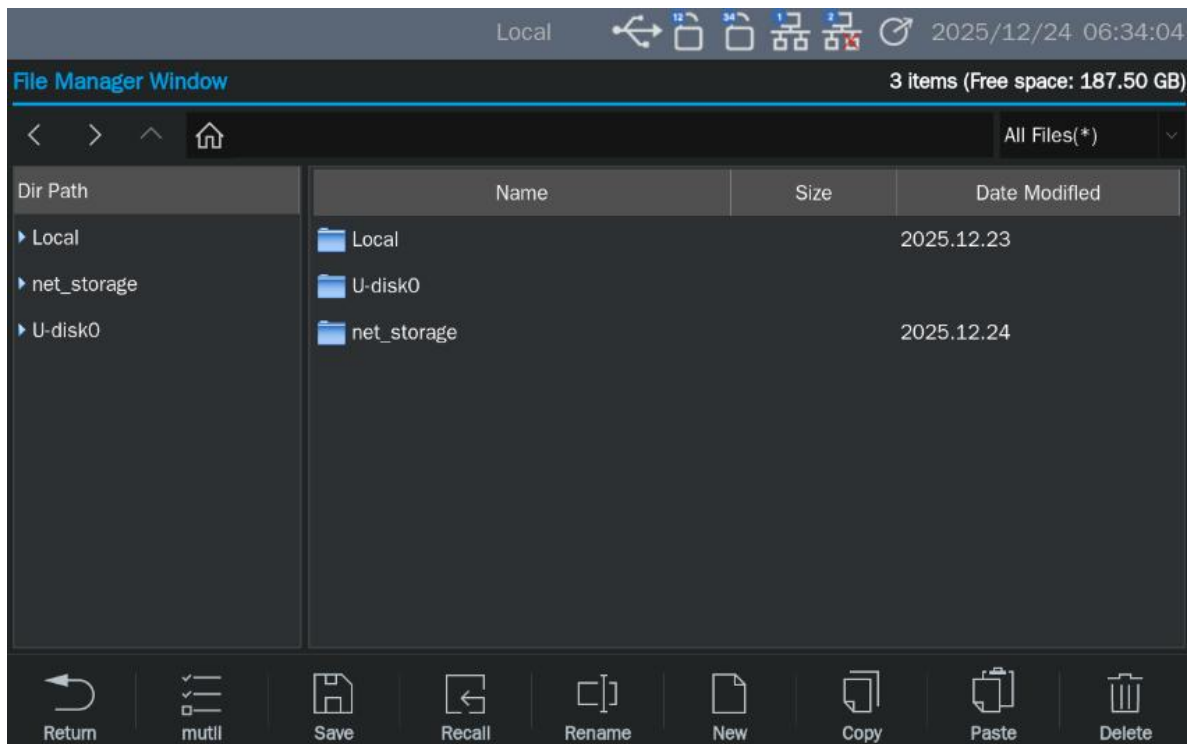

















Table 22-2 File manager icon description

Operation icon	Description	Operation icon	Description
	back		forward
	Superior directory		root directory
	return		mutil
	All		None
	Invert		Save
	Recall		Rename
	New		Copy
	Paste		Delete

22.2.1 Storage System

The device supports saving the current state of the instrument to internal, external memory or network storage (net_storage), and supports users to call it when necessary. Users can download arbitrary wave files to the internal memory through the arbitrary wave editing software EasyWaveX, or read arbitrary wave files from the U disk and save them to the internal memory.

Local

The device provides internal nonvolatile memory, and the user can save the instrument status and configuration files of each mode to the local storage disk.

USB Device (0:)

The device comes standard with USB Host, which is located on the left (1pcs) and the back (2pcs) of the instrument front panel, and supports U disk storage and firmware upgrade. When mobile media such as a USB flash drive is inserted into the USB Host interface, the letter "USB Device" will appear in the file management interface and prompt "USB device is connected". When the USB flash drive is unplugged from the USB Host interface, the system will prompt "USB device is disconnected" and the corresponding letter will disappear.

Note:

Only files with English characters, numbers and underscores can be recognized. If you use other special characters to name a file or folder, it may not be displayed normally in the file management interface.

22.2.2 File Type

Type	Description
*.xml	The status file contains the parameters set by each functional module of the instrument and the parameters set under the system setting menu.
*.bin	Binary arbitrary waveform data file, which can be directly called by equipment. The data file downloaded to the device through the upper computer EasyWaveX is also in this format.
*.csv	Arb wave data file supported by the device can be called from external memory, and at the same time, it is converted into a file in *.bin format and stored in internal memory.
*.dat	Arb wave data file supported by the device can be called from external memory, and at the same time, it is converted into a file in *.bin format and stored in internal memory.

*.mat	Arb wave data file supported by the device can be called from external memory, and at the same time, it is converted into a file in *.bin format and stored in internal memory.
*.arb	IQ data file, can be called by IQ function.
*.awgx	AWG configuration file.
*.iqx	The configuration file of IQ sequence.
*.hop	Configuration files of frequency hopping table, frequency hopping sequence table and frequency filtering table can be called by frequency hopping function.
*.ADS	Version upgrade firmware.
*.calx	Calibration documents (use requires consulting technical support).

22.2.3 Operation File

1) Save

Users can store the equipment status in the internal nonvolatile memory and external memory of the instrument, which is convenient for the next call. The specific operation of storing instrument status is as follows:

Select the storage file location

Use the knob or directly click the corresponding location on the touch screen to select the location to be stored.

save file

Select Save to enter the file name input interface.

File name input

Files can only be named in English.

Selection of characters

Users can select the required characters in the UI through the knob or touch screen, or input them through an external keyboard.

Delete character

To delete any character in the file name, you can first move the cursor position in the file name through the left and right arrow keys, and then select Delete in the operation menu to delete the corresponding character. Change the position of the cursor to delete characters at any position.

save a file

After entering the file name in the file name input interface, select Save, and the signal generator will save the file to the currently selected directory with the specified file name and file type.

2) Recall

Users can call up the equipment status or arb waveform data edited by users. The specific operation is as follows:

Select the data file to recall

Use the knob or touch screen to select the directory where the file to be read is located, and then use the knob or directly click the corresponding position on the touch screen to select the file to be recall.

Recall

Select Recall or press the knob down or click the file directly on the screen to bring up the corresponding file, and give the corresponding prompt message after reading successfully.

3) Delete

Users can delete status files and data files in internal memory and external memory. The specific operation is as follows:

Select the file to delete

Use the knob or directly click the corresponding position on the touch screen to select the file to be deleted.

Delete

Select Delete, and the prompt box "Are you sure you want to delete this file?" pops up. Select OK to delete the currently selected file.

4) Copy and paste

Support internal and external storage files to copy each other. For example, copy any wave file in the U disk to the inside of the instrument. The specific operation is as follows:

Select the file to copy

Turn the knob to select USB Device, expand the U disk directory, turn the knob to select the file to be copied, and select **Copy** .

Paste file

Select the knob or touch screen and go to the new directory where you need to store files, and then select **Paste** .

22.3 System Info

Execute **Utility** > **system information** to view the current version information of the equipment. System information includes the following contents:

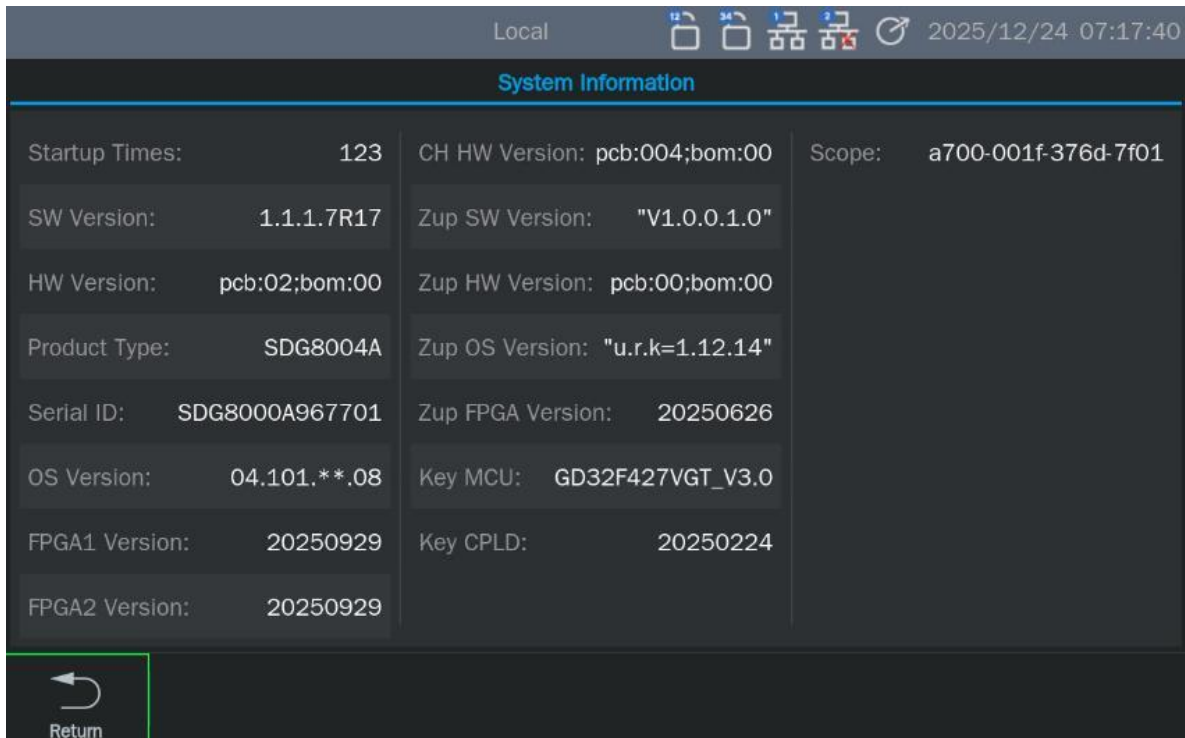

22.4 Interface

Execute **Utility** > **Interface** and enter the interface settings menu.

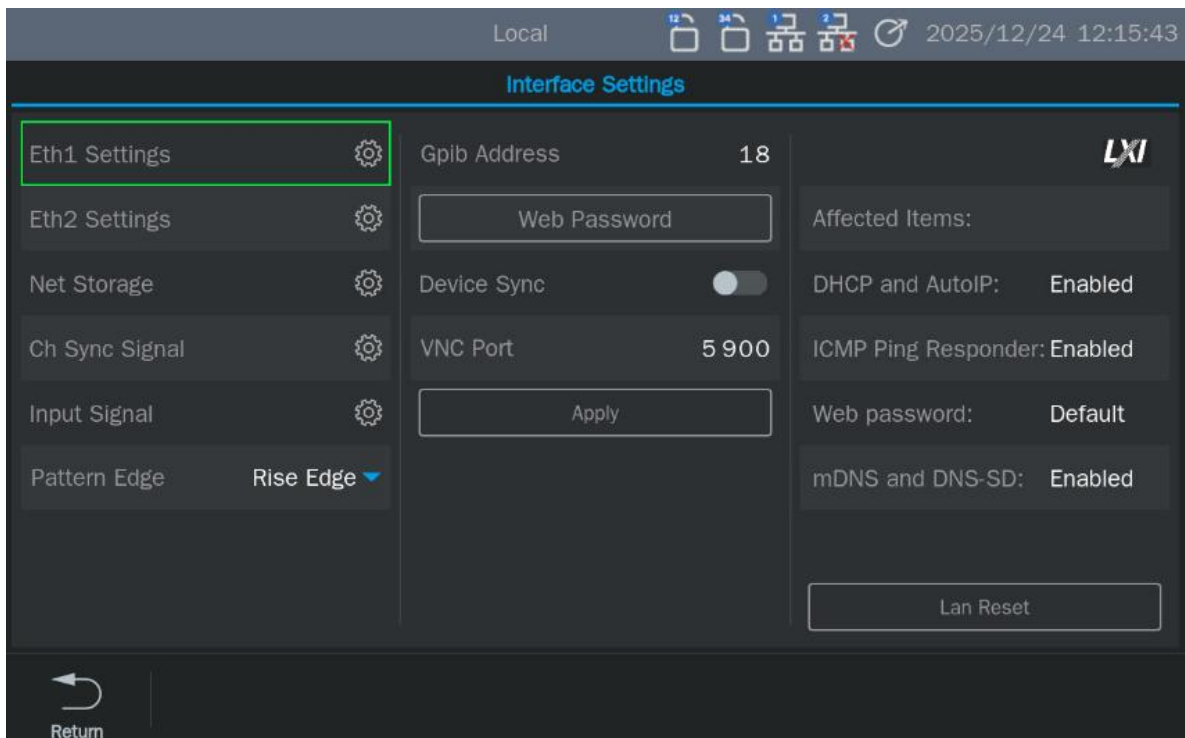

Table 22-1 Interface Settings Menu Description

Function menu	Description
Eth1/2	Network port connection setting
Net storage	Settings of network storage
Ch Sync Signal	Channel synchronization signal output setting
Input Signal	External signal input setting, synchronous trigger input and external trigger input
Pattern Edge	Set the trigger edge of dynamic jump
Gpib Address	Support Gpib port number setting
Web Password	You can set the password for web control.
Device Sync	Output synchronization between two or more devices can be realized.
VNC Port	When accessing multiple devices corresponding to the same IP address through WebServer, it is necessary to set different VNC port numbers to distinguish them, ranging from 5900 to 5999.
LXI	Support LXI

22.4.1 LAN

Support remote operation through LAN interface, you can view and modify the current LAN configuration.

1. Connecting equipment

Use a network cable to connect the device to the computer or the local area network where the computer is located.

2. Configure network parameters

Select *Utility* > *Interface* > *Eth1/2 Setting* >  and enter the interface shown below.

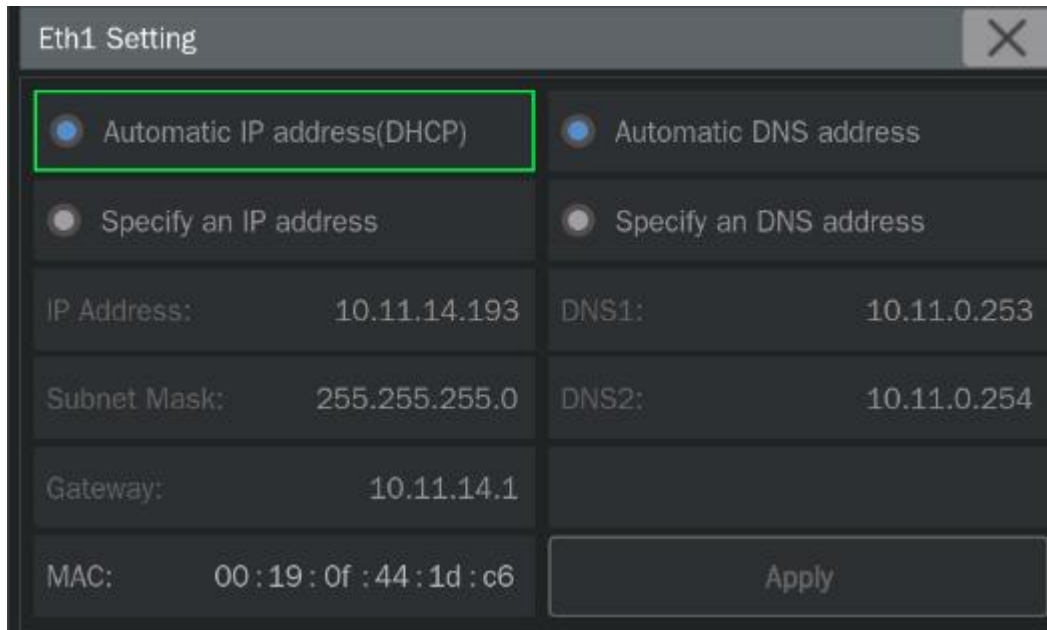

Table 22-2 Description of LAN parameter setting

Function menu	Set	Description
IP Address		Set IP address
Subnet Mask		Set subnet mask
Gateway		Set the default gateway
DHCP	On	Dynamically configure network parameters such as IP address.
	Off	Manually set network parameters such as IP address.
DNS		Set DNS
Apply		Set the currently configured network, and you will be prompted whether the setting is available or not.

Set IP address

The format of the IP address is nnn.nnn.nnn.nnn, and the range of the first nnn is 1 to 223, and the range of the other three nnns is 0 to 255. It is recommended that you ask the network administrator for an available IP address.

Select an IP address, and use the arrow keys and the numeric keypad or knob to enter the required IP address. This setting will be saved in nonvolatile memory, and the instrument will automatically load the set IP address when it is turned on next time.

Set subnet mask

The subnet mask is in the format nnn.nnn.nnn.nnn, where nnn ranges from 0 to 255. It is recommended that you consult your network administrator for an available subnet mask.

Select the subnet mask and use the arrow keys and the numeric keypad or knob to enter the required subnet mask. This setting will be saved in nonvolatile memory, and the instrument will automatically load the subnet mask when it is turned on next time.

Set the default gateway

The format of the default gateway is nnn.nnn.nnn.nnn, where nnn ranges from 0 to 255. It is recommended that you consult your network administrator for an available default gateway.

Select the default gateway, and use the arrow keys and the numeric keypad or knob to enter the desired default gateway. This setting will be saved in non-volatile memory, and the default gateway will be automatically loaded when the instrument is turned on next time.

Description

If the instrument is directly connected to the computer, set the IP address, subnet mask and default gateway of the instrument and the computer respectively. The subnet mask and default gateway of both must be the same, and their IP addresses must be in the same network segment.

If the instrument is connected to the local area network where the computer is located, please obtain the available network parameters such as IP address from your network administrator. Please refer to the knowledge about TCP/IP network protocol.

DHCP

In this mode, the DHCP server in the current network allocates network parameters such as IP address to the signal generator. To obtain IP through DHCP, select "On" or "Off" DHCP configuration mode, and the default is "Off".

22.4.2 Network Storage

Perform the following steps, the device can access the shared folder of the computer through the local area network.

Execute Utility > Interface > Network Storage >  to enter the network storage configuration page:

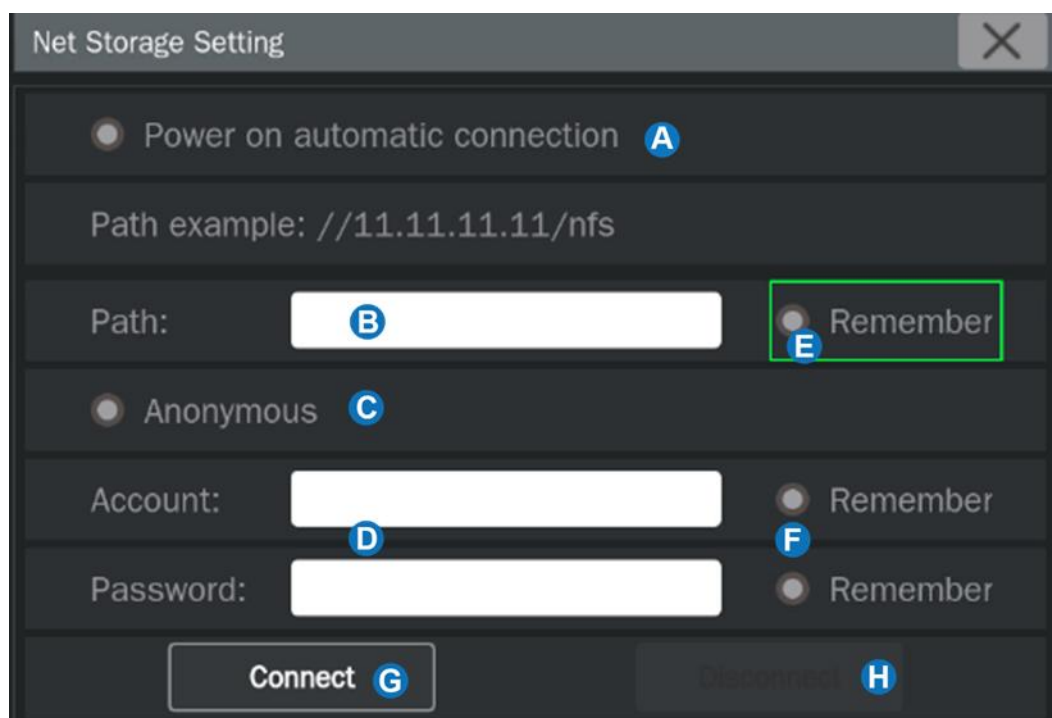

- A. You can only select this option after connecting the network storage disk, and you can automatically connect the network storage disk when you turn it on again.
- B. Set the path of the network storage disk, which consists of the IP of the computer and the shared name of the shared folder of the computer.
- C. When anonymous is not checked, you need to enter an account that can access the computer shared folder.
- D. When anonymous is not checked, you need to enter the login password corresponding to the account that can access the computer shared folder.
- E. When checked, you can access the shared folder without entering an account or password (the computer needs to enable the Guest account and the shared folder is authorized to the guest user).
- F. When checked, you will remember the path, account and password.
- G. Log in to access shared folders.
- H. Disconnect the shared folder

22.4.3 Sync Signal

When it is turned on synchronously, the **【CH1/2/3/4 Trig Out】** interface on the back panel of the instrument can output a signal with the same frequency as the basic waveform (except Noise and DC), arbitrary waveform and modulation waveform (except external modulation), and the maximum frequency is 10 MHz. The synchronous output signal of each channel is set separately, including output type and synchronous output state; The rear panel interface is also independent.

Execute **Utility** > **Interface** > **Ch Sync Signal** >  to enter the synchronization setting interface.

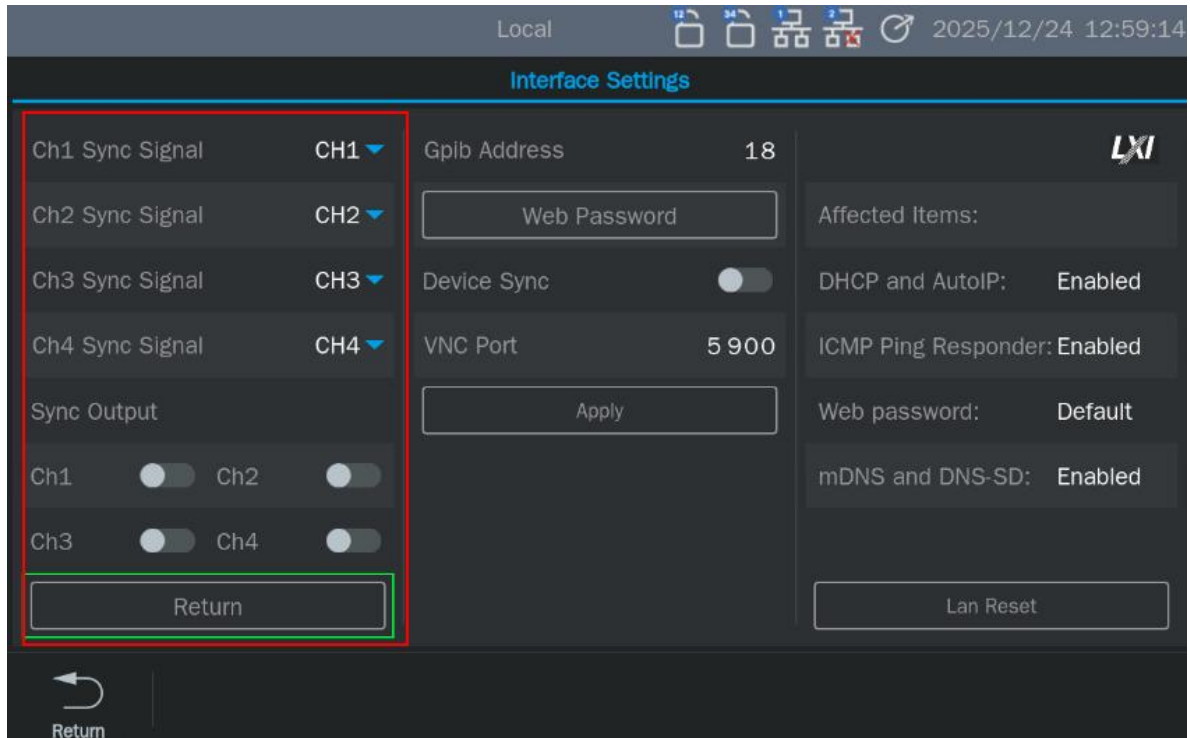

Table 22-3 Synchronization Settings Function Menu Description

Function menu	Set	Description
State	On	Turn on synchronous output
	Off	Turn off synchronous output
Ch1/2/3/4 synchronization signal	CH1/2/3/4	Select the channel as the source of synchronous output.
	MOD-CH1/2/3/4	Select the source of channel modulation as synchronous output.
Return		Complete synchronization settings and return to the previous menu.

Synchronization signal of waveform :

1. Basic waveform

When the frequency of the basic waveform is less than or equal to 10 MHz, the synchronization signal is a pulse wave with a fixed pulse width of 100 ns, and the frequency is the frequency of the basic waveform.

When the frequency of the basic waveform is greater than 10 MHz, there is no synchronization signal.

Noise and DC: No synchronous signal.

2. Arbitrary wave

The synchronization signal is a pulse wave with a fixed pulse width of 100 ns and a frequency of arbitrary waveform.

3. Modulation waveform

In internal modulation, the synchronization signal is a pulse wave with a fixed pulse width of 100 ns.

For AM, DSB-SC, FM, PM and PWM, the frequency of the synchronization signal is the modulation frequency.

For ASK, FSK and PSK, the frequency of the synchronization signal is the keying frequency.

For external modulation, the [Mod In] interface on the back panel of the instrument is used to receive external analog modulation signals; [Trig In 1/2] interface is used to receive external digital modulation signals.

22.4.4 Input Signal

The loads (10 K Ω and 50 Ω) of the synchronous input signal interface (Sync In) and the external trigger input interfaces (Trig In 1 and Trig In 2) and the trigger level threshold (-5 V ~ 5 V) can be set.

Execute **Utility** > **Interface** > **Input Signal** >  to enter the setting interface of input signal.

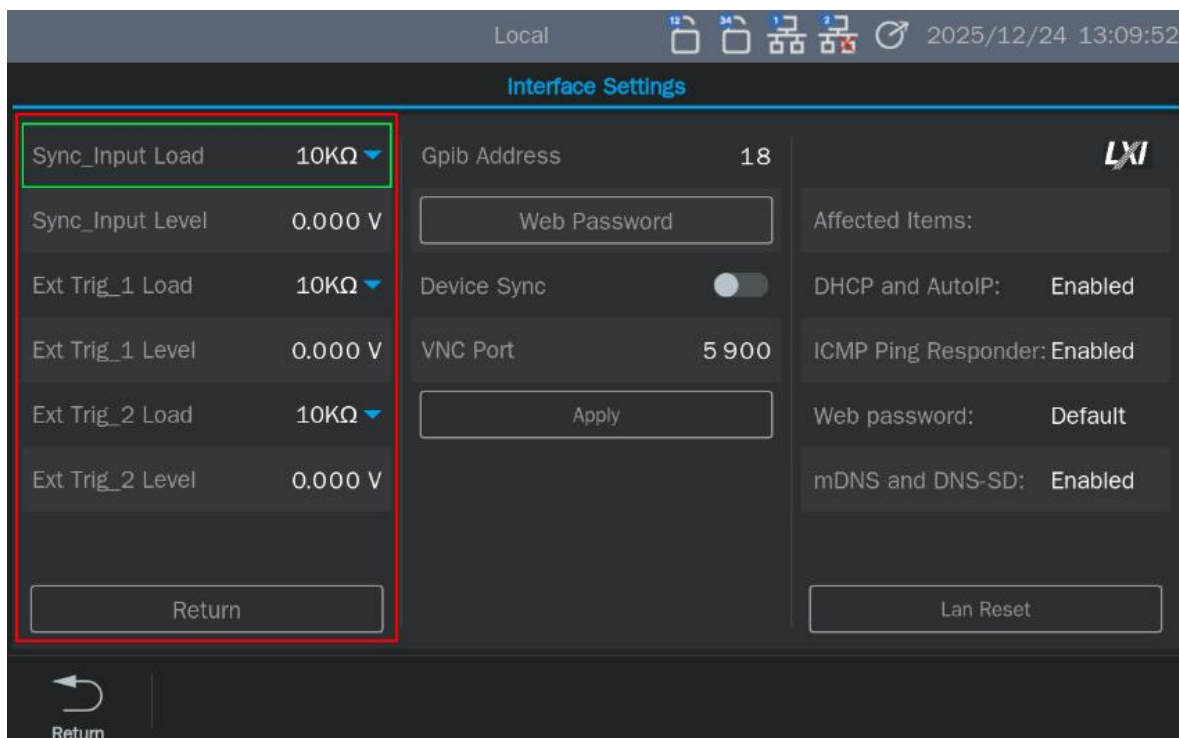

22.4.5 Pattern Edge

Used to set the trigger valid edge of dynamic jump input signal, which is used in conjunction with the chapter "12.10 Dynamic Jump".

22.4.6 GPIB Settings

Every device on the GPIB interface must have a unique address. GPIB factory default value is 18, and the setting range is 1-30. The selected address is saved in non-volatile memory and displayed at power-on.

1. Connecting equipment

Use USB-GPIB module (option) to connect the equipment to the computer. Please ensure that your computer has a GPIB card installed, and then connect the USB end of USB-GPIB module to the USB Host interface on the front panel of the device, and connect the GPIB end of USB-GPIB module to the GPIB card port of the computer.

2. Computer installation GPIB card driver

Please install the GPIB card driver connected to the computer correctly.

3. Set the GPIB address of the instrument

Execute **Utility** > **Interface** > **GPIB Address** , and the user can change its value by rotating the knob, direction keys and numeric keypad. After input, select OK to save the current settings.

4. Communicate remotely with a computer

Open the "Measurement & Automation Explorer" software, and after successfully adding GPIB devices, open the remote command control panel, through which you can send commands and read data.

22.4.7 Web Password

After the device is connected to the network cable and the network port is correctly set, the computer in the local area network can input the IP of the device in the search box of the browser for remote operation on the web side, control the signal source, and set the webpage password as required, which is required for remote operation on the web. Refer to section "7.1 Web".

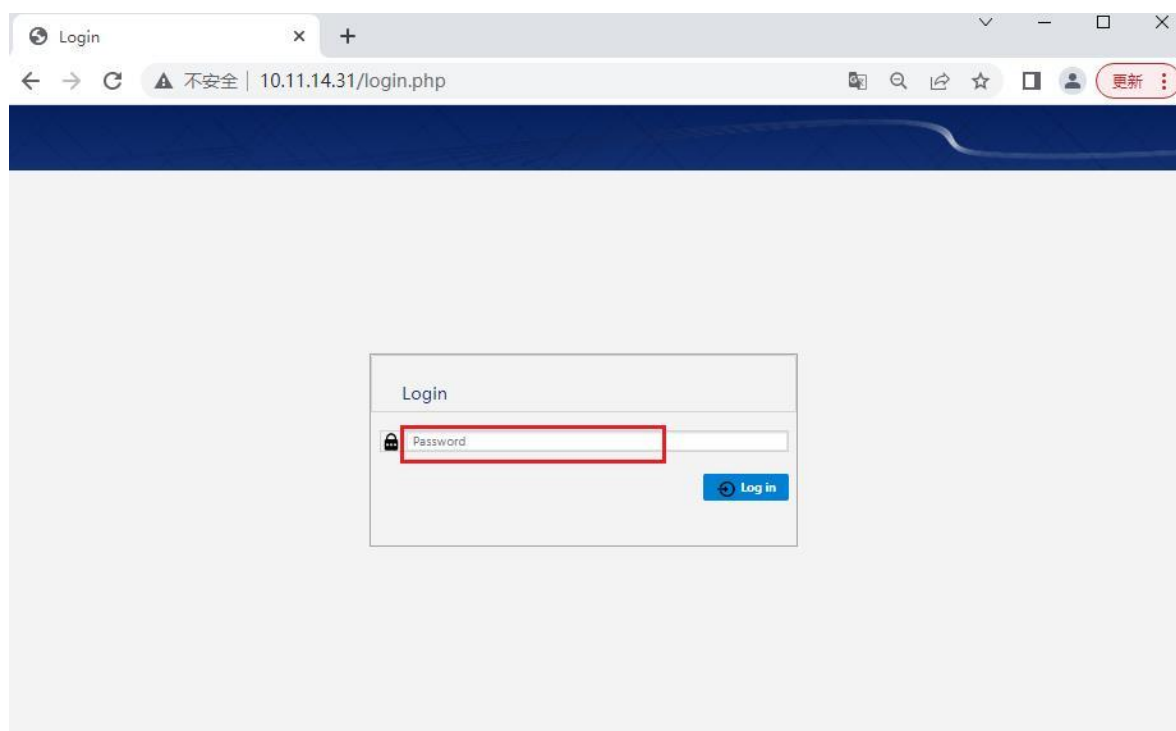

22.4.8 Device Sync

It supports synchronization between two or more devices and can realize in-phase output, which is used to expand multiple two-channel devices to four or more channels. Execute **Utility** > **Interface** > **Device Sync** to enter the multi-device synchronization setting interface.

Synchronization method between instruments:

Synchronization of two instruments

Connect **【10M Ref Clock Out】** of the master (internal clock source) to **【10M Ref Clock In】** of the slave (external clock source), and connect **【Sync Out】** of the master to **【Sync In】** of the slave, turn on the channel output, and press the synchronization device in the master to realize the synchronization of the two instruments.

Synchronization of multiple instruments

Divide **【10M Ref Clock Out】** and **【Sync Out】** of the host (internal clock source) into multiple channels, and then connect them to **【10M Ref Clock In】** and **【Sync In】** of multiple instruments (external clock source) respectively. After opening the output, press the synchronization device in the host to realize the synchronization of multiple instruments.

There is actually a certain phase difference between the output waveforms of the slave and the master, and the phase difference is related to the SMA cable used. It is recommended to use the SMA

cable as standard. Fixed phase difference can be compensated by *Slave Delay* , and larger delay can be adjusted by " Output Skew" in "Output Setting".

22.4.9 VNC Port

When accessing multiple devices corresponding to the same IP address through WebServer, it is necessary to set different VNC port numbers to distinguish them, ranging from 5900 to 5999.

22.4.10 LXI

Resetting the network configuration through LXI will turn on DHCP and automatic IP, turn on ICMP Ping response, turn on mDNS and DNS-SD, and restore the webpage password setting to the factory value.

22.5 Test/Cal

Support self-test functions, including screen test, key test, LED test and board test; Self-calibration and time-base calibration functions are supported, and users can choose whether to use factory calibration data or user calibration data.

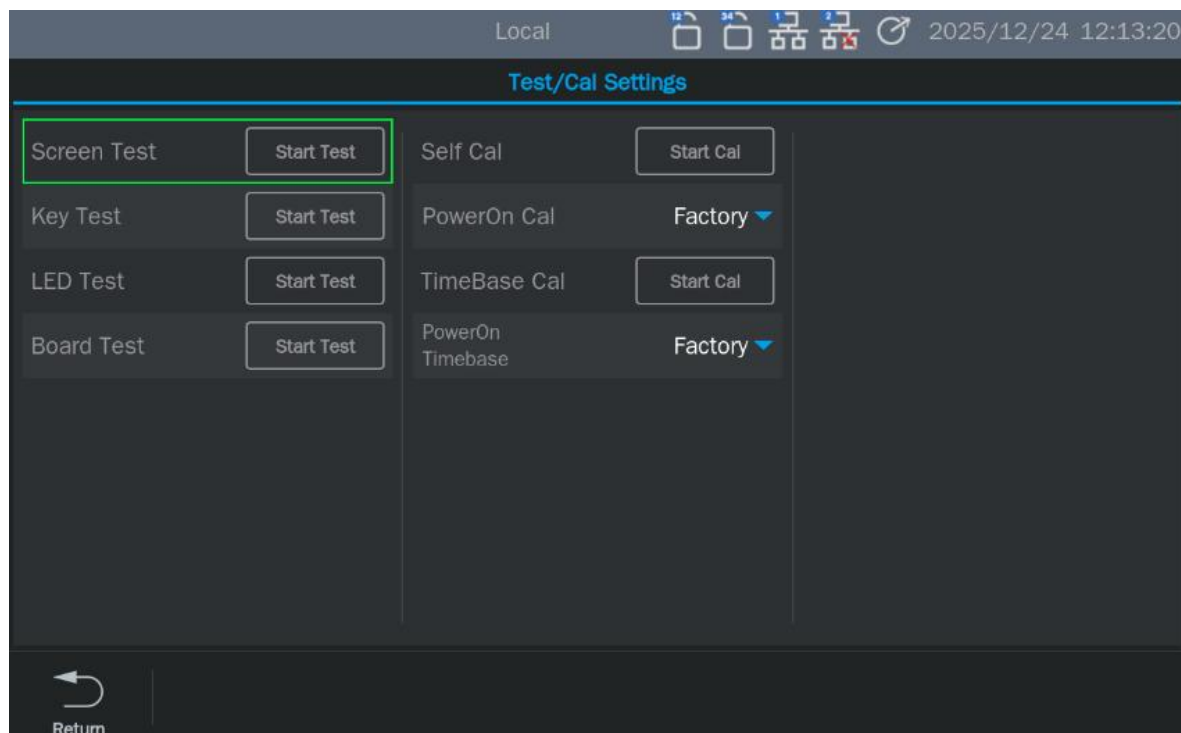

22.5.1 Screen Test

Screen testing is mainly used to find out whether there are serious color cast, bad spots or screen scratches on the device display.

Execute `Utility` > `Test/Cal` > `Screen Test` , and the device will enter the screen test interface shown below, and the interface will display pure red.

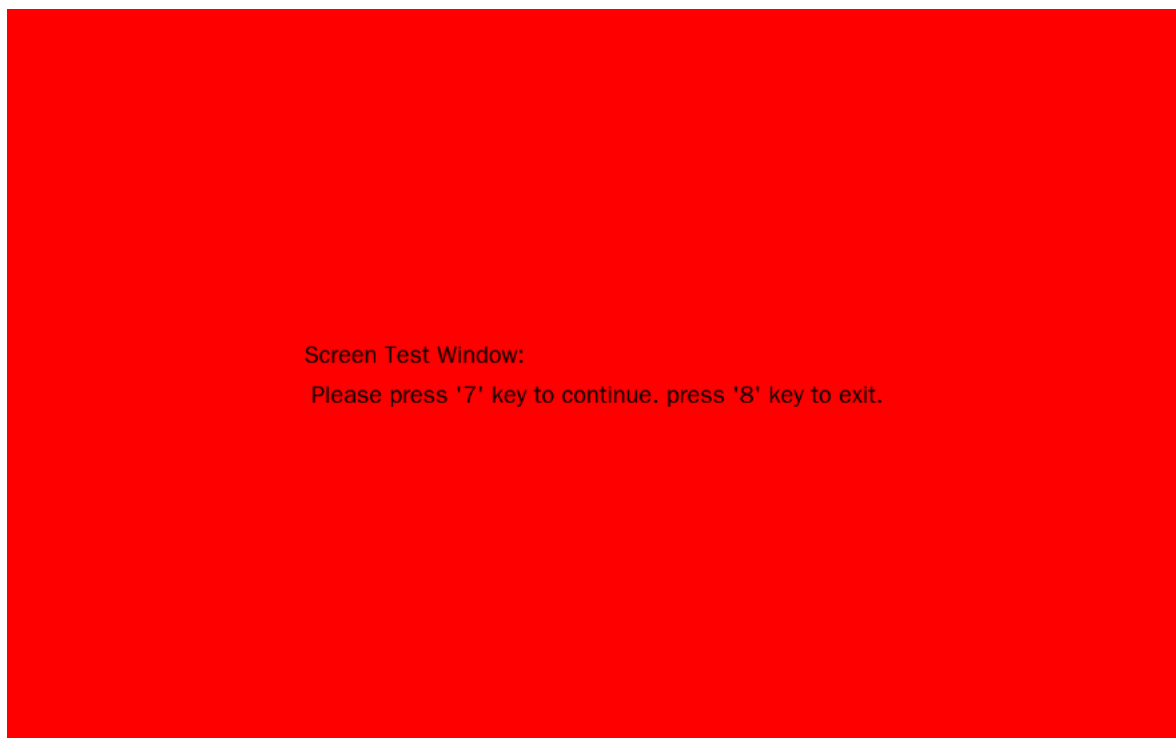

Press `7` keys continuously according to the screen prompt information to switch to the green and blue screen display mode. Observe whether there are serious color differences, stains or scratches on the screen under the interface corresponding to each color.

Press the `7` key repeatedly to switch the test interface of different colors until it is finalized. Then press the `8` key to exit the screen test mode.

22.5.2 Key Test

The key test is mainly used to find the problems of unresponsiveness or insensitivity of the keys or knobs on the front panel of the equipment.

Execute `Utility` > `Test/Cal` > `Key Test` , and the equipment will enter the following interface:

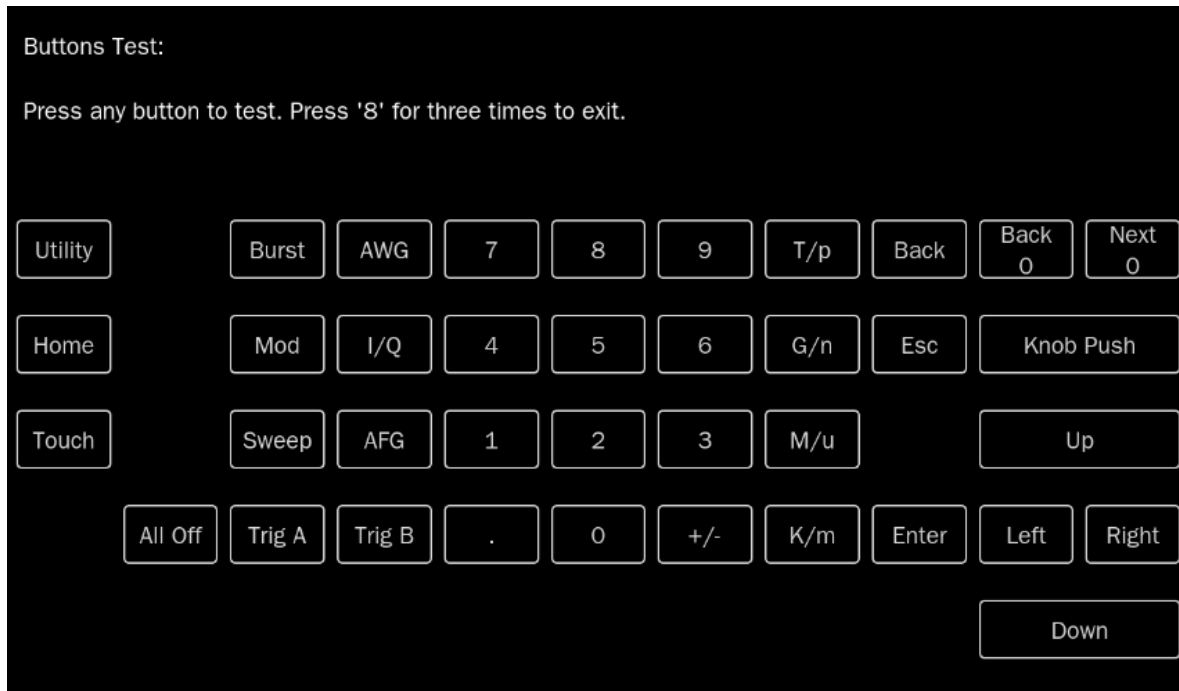

22.5.3 LED Test

The LED test is mainly used to find out whether the key lights on the front panel of the equipment can be lit and the brightness is poor.

Execute **Utility** > **Test/Cal** > **LED Test**, and the equipment will enter the interface shown below:



As shown in the above figure, after pressing the **7** key according to the prompt information on the

screen, the first LED on the front panel is lit, and the corresponding position of the key in the screen is lit. Press key 7 continuously to switch to the next key light. Press 7 keys continuously according to this method until all key lights are tested, and observe whether all key lights on the front panel can be lit in real time.

After all the key lights are tested, press the 8 key according to the screen prompts to exit the test mode.

22.5.4 Board Test

Board test mainly carries out self-check on some key chips of the equipment, which can be performed when the equipment fails to confirm whether it is caused by hardware failure. Execute Utility > Test/Cal > Board Test, and the equipment will enter the interface shown below. If all devices prompt "Pass", it means that the key chips are working normally, otherwise, the devices need to be overhauled to return to normal.



22.5.5 SelfCal/PowerOn Cal

Support user self-calibration, which is used to calibrate output amplitude, common mode and differential mode deviation; Support users to choose to use factory self-calibration data (factory data) or user-calibrated data (user data).

Note: Use the time base calibration function with caution, and contact technical support if necessary.

22.5.6 TimeBase Cal/PowerOn Timebase

Support user time base calibration, which is used to calibrate the internal reference clock of the equipment; Support users to choose to use factory time-base calibration data (factory data) or user-calibrated data (user data).

Note: Use the time base calibration function with caution, and contact technical support if necessary.

22.6 Preset

Execute **Utility** > **settings** to enter the preset interface.

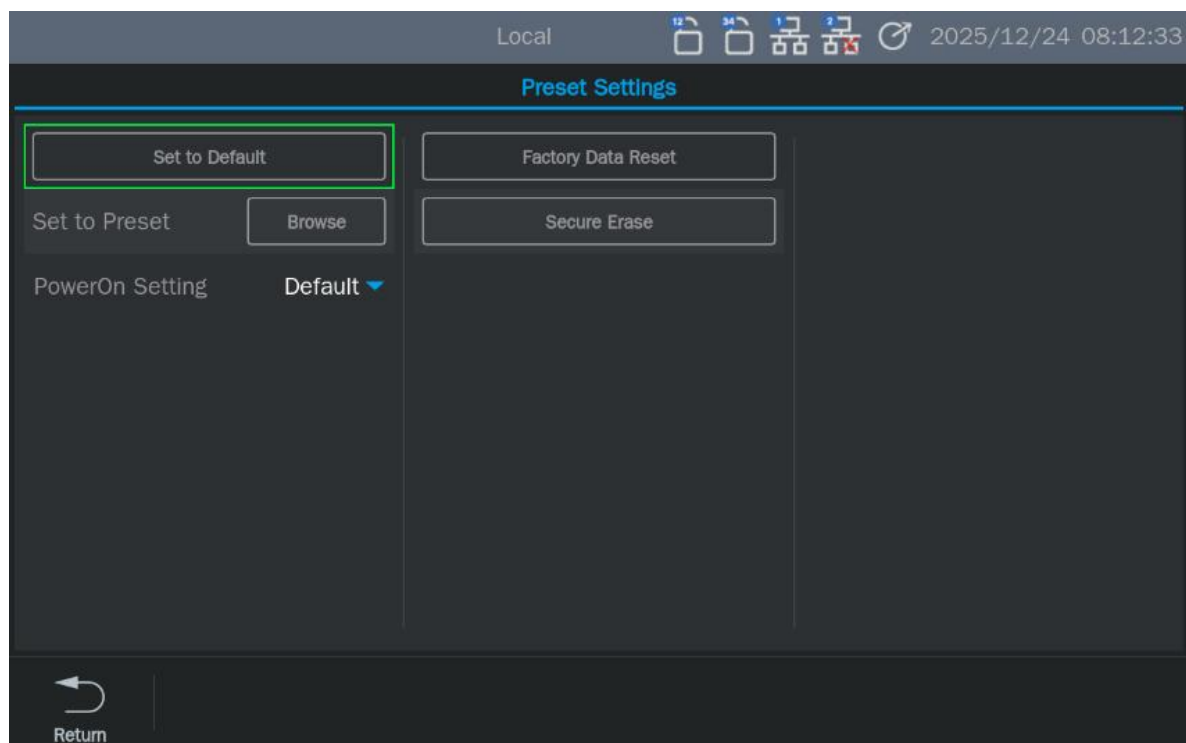

Table 22-4 Preset type

Preset type	Description
Set to Default	Restore the factory preset default configuration
Set to Preset	Configure the device according to the saved configuration file
PowerOn Setting	Default: the default configuration preset by the factory is loaded at power-on.
	Last: the configuration before the last shutdown was loaded at power-on.
	User: the configuration in the configuration file specified by the user is loaded at power-on.

Factory Data Reset	Delete all user settings, excluding all waveform files and status files stored in Local storage disk (local path), and restore all configurations to factory default configurations.
Secure Erase	Delete all user settings, including all waveform files and status files stored in Local storage disk (local path), and restore all configurations to factory default configurations.

22.7 Update

Select the ADS firmware to be upgraded through **Utility** > *update*, and then recall it.

22.8 Options

The equipment provides a variety of optional functions to meet the measurement needs of users. Please contact **SIGLENT** sales or technical support personnel to obtain the corresponding option license key or license key file. You can view the option information or activate the newly purchased option license key on the signal source.

There are two ways to activate the option:

1. Option Type Select the option type to be installed, enter the license key with a character length of 16 in the key input box, and click "Install" to activate.
2. Copy the license key file corresponding to the option to be installed to the root directory of U disk, plug it into the signal source, and click "Install from U-disk" in the option interface after correct identification, and the option will be automatically activated.

Follow these steps to perform the option installation function:

Utility > *Options*

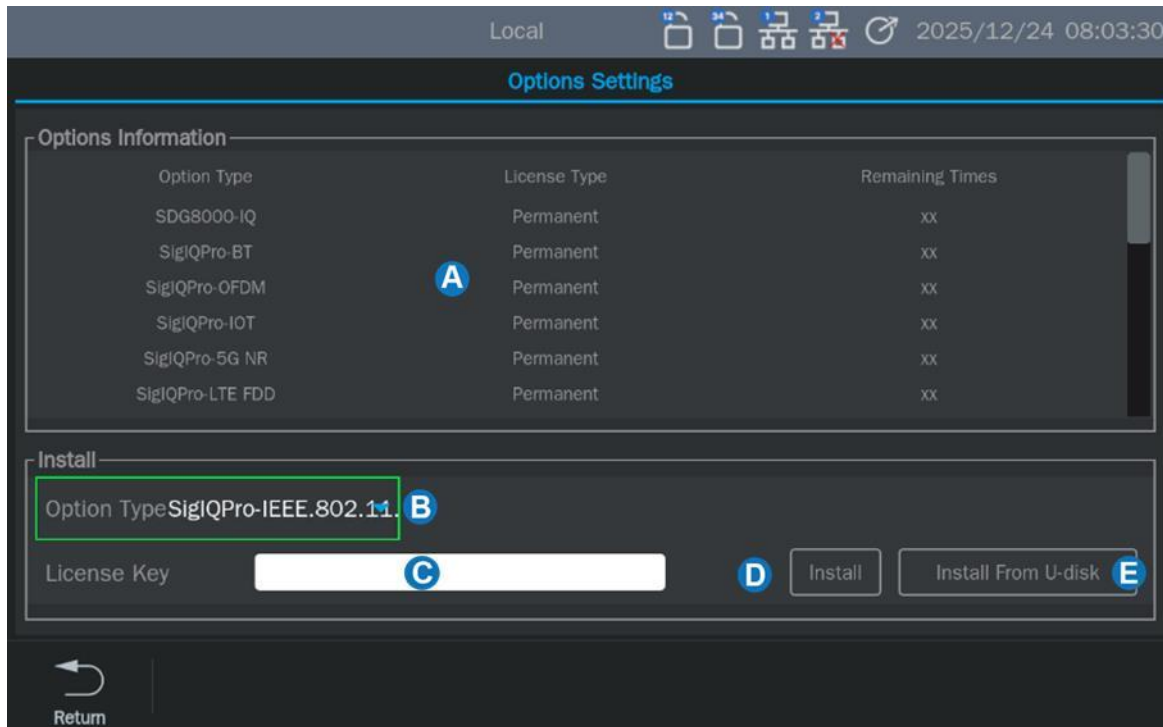

- A. Option information display area. When the selected item is not activated, the License Type will be displayed as "Temporary", which can be tried for up to 30 times.
- B. Select the type of option to install.
- C. In the key input area, click the text box to pop up a virtual keyboard for entering the key.
- D. Enter the secret key and click Execute Installation.
- E. Use the option of automatic installation of U disk, and the key file should be stored in the root directory of U disk.

22.9 Help

Execute `Utility` > `help` to view the help information of the device.

22.10 Copyrights

You can view the open source information of the device by executing the `Utility` > `copyrights` .

23 General Inspection and Troubleshooting

23.1 General Inspection

Inspect the shipping container

Keep the original shipping container and cushioning material until the contents of the shipment have been completely checked and the instrument has passed both electrical and mechanical tests.

The consigner or carrier will be responsible for damages to the instrument resulting from shipment.

SIGLENT will not provide free maintenance or replacement if the instrument has been damaged in shipment.

Inspect the instrument

If there are instruments found damaged, defective, or have failed any electrical and / or mechanical tests, please contact SIGLENT.

Check the accessories

Please check the accessories according to the packing list. If the accessories are incomplete or damaged, please contact your SIGLENT sales representative.

23.2 Troubleshooting

If the LCD screen remains black after pressing the power switch, perform the following checks:

- Verify that the power supply is connected and powered on.
- Restart the instrument.
- If the issue persists, contact SIGLENT for assistance.

If the settings are correct but there is no waveform output, please follow the following steps to handle it:

- Verify that the signal connection cable is properly connected to the Output port.
- Ensure the cable is securely connected.
- Confirm that the channel output and run switch are turned on.

24 Service and Support

24.1 Warranty summary

SIGLENT warrants that the products it manufactures and sells will be free from defects in materials and workmanship for three years from the date of shipment from an authorized **SIGLENT** distributor. If a product is proved to be defective within the warranty period, **SIGLENT** will provide repair or replace the unit as described in the complete warranty statement.

To arrange for service or obtain a copy of the complete warranty statement, please contact your nearest **SIGLENT** sales and service office. Except as provided in this summary or the applicable warranty statement, **SIGLENT** makes no warranty of any kind, express or implied, including but not limited to the implied warranties of merchantability and special applicability. In no event shall **SIGLENT** be liable for indirect, special or consequential damages.

APPENDIX A

SDG8000A Series Function/Arbitrary Waveform Generator Accessories:

Standard Accessories:

A power cord that meets the standards of the host country

One USB data cable

A wireless mouse

Four (SDG8002A) or eight (SDG8004A) 50 Ω terminals

A product qualification certificate

A product calibration report

A Quick Guide

Two BNC coaxial cable

Purchase attachments:

USB-GPIB adapter

High precision OCXO reference source

Dynamic jump interface cable

APPENDIX B

Default setting

The default settings for SDG8000A series functions/arbitrary waveform generators are as follows:

Item	Default state
Channel default state	Off
DC Output	
on/off	Off
offset	0 V
Basic waveform	
Frequency	10 MHz
Amplitude	0.5 V
Offset	0 V
Phase	0°
Symmetry	50%
AM (default)	
Source selection	internal
modulated waveform	Sine
modulation frequency	100 Hz
modulation depth	100%
FM	
Source selection	internal
modulated waveform	Sine
modulation frequency	100 Hz
Frequency deviation	100 Hz
PM	
Source selection	internal
modulated waveform	Sine
modulation frequency	100 Hz
phase deviation	100°
ASK	
Source selection	internal
Keying frequency	100 Hz
FSK	

Item	Default state
Source selection	internal
Keying frequency	100 Hz
Frequency hopping	1 MHz
PSK	
Source selection	internal
Modulation Rate	100 Hz
polarity	positive
PWM	
Source selection	internal
modulated waveform	Sine
modulation frequency	100 Hz
Pulse width deviation	10 ns
Sweep	
Sweep Time	1 s
Start frequency	20 MHz
Stop frequency	10 MHz
Frequency span	10 MHz
center frequency	15 MHz
Trigger Source	internal
Trigger Output	Off
Scanning method	linear
Scanning direction	up
Burst	
Burst Period	10 ms
Starting phase	0.00°
Burst mode	NCycle
N cycles	1 Cyc
Trigger Source	internal
Trigger Output	Off
delay	875 ns

Note: The AFG default startup parameters of the channel are the same.

APPENDIX C

Daily maintenance and cleaning

Daily maintenance

When storing or placing the instrument, do not expose the LCD monitor to direct sunlight for a long time.



To avoid damaging the instrument or connecting wires, do not place them in mist, liquids, or solvents.

Cleaning

Regularly inspect the instruments and probes according to the operating conditions. Please clean the outer surface of the instrument according to the following steps:

1. Use a soft cloth to wipe off the floating dust on the outside of the instrument and connecting wires. When cleaning the LCD screen, be careful not to scratch the transparent plastic protective screen.
2. Use a soft cloth soaked in water to clean the instrument, please be careful to disconnect the power.



To avoid damaging the surface of the instrument or connecting wires, do not use any abrasive or chemical cleaning agents.

Before re powering on for use, please confirm that the instrument has dried thoroughly to avoid electrical short circuits or even personal injury caused by moisture.



About SIGLENT

SIGLENT is an international high-tech company, concentrating on R&D, sales, production and services of electronic test & measurement instruments.

SIGLENT first began developing digital oscilloscopes independently in 2002. After more than a decade of continuous development, SIGLENT has extended its product line to include digital oscilloscopes, isolated handheld oscilloscopes, spectrum analyzers, function/arbitrary waveform generators, RF/MW signal generators, vector network analyzers, digital multimeters, DC power supplies, electronic loads and other general purpose test instrumentation. Since its first oscilloscope was launched in 2005, SIGLENT has become the fastest growing manufacturer of digital oscilloscopes. We firmly believe that today SIGLENT is the best value in electronic test & measurement.

Headquarters:

SIGLENT Technologies Co., Ltd

Add: Bldg No.4 & No.5, Antongda Industrial Zone,
3rd Liuxian Road, Bao'an District, Shenzhen,
518101, China

Manufacturer add: No.26, Lane 2, 1st Liuxian Road,
Bao'an District, Shenzhen 518101, China

Tel: + 86 755 3688 7876

Fax: + 86 755 3359 1582

Email: sales@siglent.com

Website: int.siglent.com

North America:

SIGLENT Technologies NA, Inc

Add: 6557 Cochran Rd Solon, Ohio 44139

Tel: 440-398-5800

Toll Free: 877-515-5551

Fax: 440-399-1211

Email: support@siglentna.com

Website: www.siglentna.com

Europe:

SIGLENT Technologies Germany GmbH

Add: Staetzlinger Str. 70

86165 Augsburg, Germany

Tel: +49(0)-821-666 0 111 0

Fax: +49(0)-821-666 0 111 22

Email: info-eu@siglent.com

Website: www.siglenteu.com

Malaysia:

SIGLENT Technologies (M) Sdn.Bhd

Add: NO.6 Lorong Jelawat 4

Kawasan Perusahaan Seberang Jaya
13700, Perai Pulau Pinang

Tel: 006-04-3998964

Email: sales@siglent.com

Website: int.siglent.com

Follow us on
Facebook: SiglentTech

