



Quick Start Guide

AT-8000-EUR Advanced Wire Tracer

Reliable, precise
breaker/fuse identification

Tested by Fluke and safety
certified by 3rd party labs



Intuitive Transmitter
automatically senses whether
the system is energized or
de-energized

Most accurate wire tracing
in its class with 10
sensitivity modes

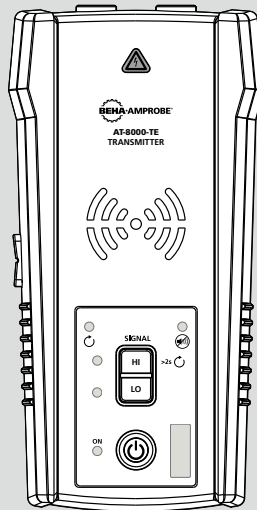
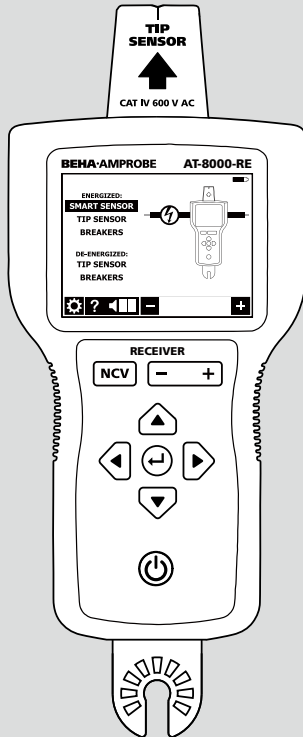
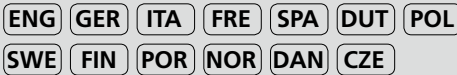

Quick Guide Table of Contents

Tracing Energized Wires - Smart Sensor™	2
Tracing Energized and De-energized Wires - Tip Sensor	3
Connecting Transmitter to an Energized Working System	4
Identifying Energized and De-energized Breakers and Fuses	5
NCV Mode	6
Finding Breaks and Opens	7
Finding Shorts	8
Wire Tracer Specifications	9
Accessory Specifications and Included in Wire Tracer Kits	10

AT-8000-EUR Advanced Wire Tracer Special Applications:

- RCD-protected circuit wire tracing
- Find breaks, openings, and shorts
- Trace wires in metal conduit: junction box method
- Trace non-metallic pipes and conduits
- Trace shielded wires
- Trace underground wires
- Trace low voltage wires and data cables
- Sort bundled wires
- Map circuits using test leads connection
- Trace breakers/fuses on system with light dimmers
- CT-400-EUR signal clamp (optional accessory) to improve accuracy and performance when there is no access to bare conductors

See the user manual for further instructions regarding special applications.

Tracing Energized Wires - Smart Sensor™

1 Set-up: Test Leads

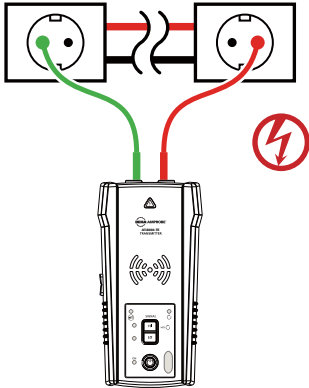

1. **Plug** the green and red test leads into the Transmitter.
2. **Connect** the green wire to a separate neutral.
3. **Connect** the red test lead to the wire being traced, For receptacles, make sure to connect the test lead to the line/phase wire. For Energized systems the signal will ONLY be transmitted between the load-side to which the Transmitter is connected and the source of power.

2 Set-up: Transmitter

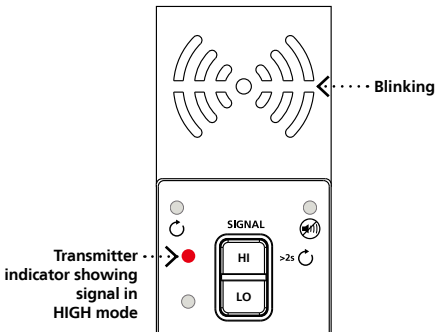

1. **Turn on** the Transmitter.
2. **Verify** that the test leads are properly connected; the red LED voltage status light should be on for circuits with voltage above 30 V AC/DC.
3. **Select HIGH signal mode** by pressing HI.

Receiver:

Energized Smart Sensor™ Mode

The **Smart Sensor™** enables easier wire tracing by showing the direction and position of the wire and is the recommended method for tracing Energized wires.

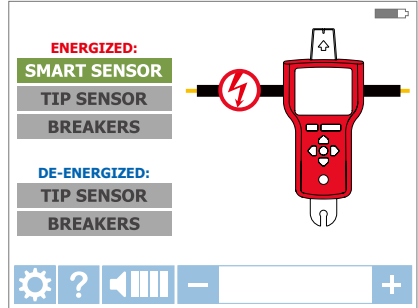

1. **Turn on** the Receiver and select SMART SENSOR™ mode using the directional arrows.
2. **Hold** the Receiver with the Smart Sensor™ facing the target area.
3. **Move** the Receiver in direction indicated by the arrow on the screen. If the screen flashes a "?" in a red target then either no signal is detected or the signal is not adequate enough to display direction; increase the sensitivity using the "+" button on the Receiver.
4. **Press ENTER** when complete to return to the home screen.

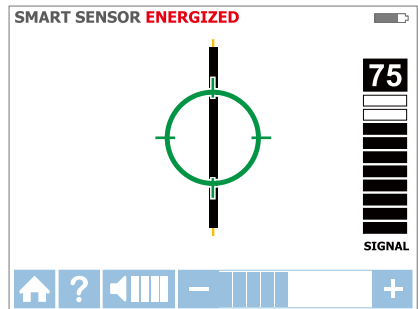

Receiver locked on wire

- TIP:** For best results, keep the Receiver at least 1 m (3 feet) from the Transmitter and its test leads to minimize signal interference and improve wire tracing results. Select the "Long" Smart Sensor™ Range in the Settings Menu if working with wires that are greater than 1 m (3 feet) deep.

Tracing Energized and De-energized Wires - Tip Sensor

1 Set-up: Test Leads

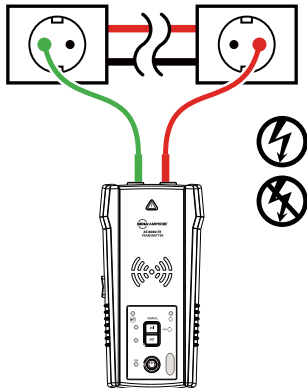

1. **Plug** the green and red test leads into the Transmitter.
2. **Connect** the green wire to a separate neutral.
3. **Connect** the red test lead to the wire being traced, For receptacles, make sure to connect the test lead to the line/phase wire. For Energized systems the signal will ONLY be transmitted between the load-side to which the Transmitter is connected and the source of power.

2 Set-up: Transmitter

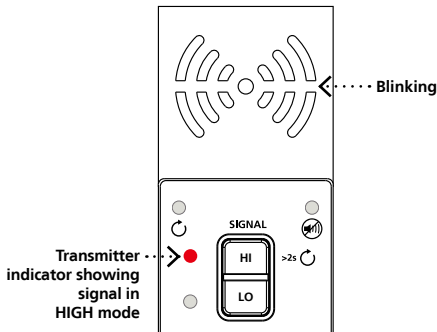

1. **Turn on** the Transmitter.
2. **Verify** that the test leads are properly connected; the red LED voltage status light should be on for circuits with voltage above 30 V AC/DC, and it should be off for De-energized circuits below 30 V AC/DC.
3. **Select HIGH signal mode** by pressing HI.

Receiver: Energized and De-energized Tip Sensor Modes

Use this mode for pinpointing a wire in a bundle or tracing in corners and confined spaces such as junction boxes and inside enclosures.

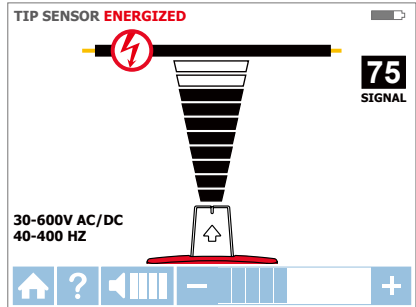

Receiver screen showing signal detected in Energized TIP SENSOR mode

1. **Turn on** the Receiver and select either Energized or De-energized TIP SENSOR mode using the directional arrows.
2. **Hold** the Receiver with the Tip Sensor facing the target area.
3. **Scan** the target area with the Tip Sensor to find the highest signal level, then begin tracing the detected wire. Increase or decrease sensitivity of the Receiver by pressing + or - on the keypad as necessary.
4. **Press ENTER** when complete to return to the home screen.

TIP: In Energized mode, align the groove on the Tip Sensor with the wire direction for best results; the signal may not be detected without this alignment. De-energized mode uses a different antenna in the Tip Sensor than Energized mode. Specific alignment of the Tip Sensor groove to the wire is not required. De-energized wire tracing results are based only on how close the Tip Sensor is to the wire.

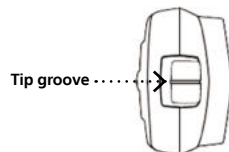
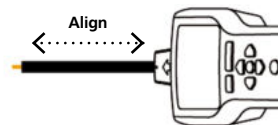

Aligning the Tip Sensor with the wire

Connecting Transmitter to an Energized Working System

The Transmitter, with the red test lead, can be directly connected to the live wire of the working electrical equipment under load (motor, electronics, etc). Tracing can be performed without needing to turn off the equipment or switching power off.

Identifying Energized and De-energized Breakers and Fuses

1 Set-up: Test Leads

- Plug** the green and red test leads into the Transmitter.
- Connect** the green wire to a separate neutral.
- Connect** the red test lead to the wire being traced, For receptacles, make sure to connect the test lead to the line/phase wire. For Energized systems the signal will ONLY be transmitted between the load-side to which the Transmitter is connected and the source of power.

Note: Simplified direct connection can also be used to connect the Transmitter (refer to the user manual for further instructions).

2 Set-up: Transmitter

Transmitter indicator showing signal in HIGH mode

- Turn on** the Transmitter.
- Verify** that the test leads are properly connected; the red LED voltage status light should be on for circuits with voltage above 30 V AC/DC, and it should be off for De-energized circuits below 30 V AC/DC.
- Select HIGH signal mode** by pressing HI.

Identifying Energized and De-energized Breakers and Fuses

Receiver:

BREAKERS Mode

Tracing breakers/fuses is a two-step process:

- 1. SCAN** - Scan each breaker/fuse for one second. The Receiver will record tracing signal levels.
- 2. LOCATE** - The Receiver will indicate the single breaker/fuse with the strongest recorded signal.

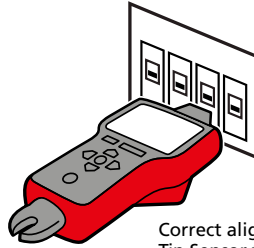

Correct alignment of the Tip Sensor to the breaker/fuse

Step 1 - 1 SCAN

- 1. Turn on** the Receiver and select either Energized BREAKERS mode or De-Energized BREAKERS mode using the directional arrows.
- 2. Align** the groove on the Tip Sensor with the breaker/fuse lengthwise.
- 3. Scan** each breaker/fuse by touching it with the Tip Sensor. To assure sufficient time between the scans, wait for active green arrow and audible alert before moving to the next breaker/fuse. The order of scanning does not matter. You can scan breakers/fuses multiple times. The Receiver records the highest detected signal.

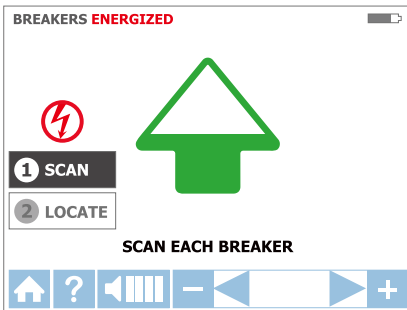

Step 2 - 2 LOCATE

- 1. Select LOCATE** mode by using the directional arrows.
- 2. Rescan** each breaker by touching each with the Tip Sensor for one second. Active red arrow indicates scanning process. Scan all breakers until solid green arrow and audible alert (continuous beep) indicates that the correct breaker was found.
- 3. Press ENTER** when complete to return to the home screen.

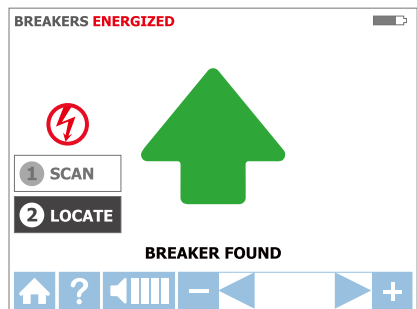
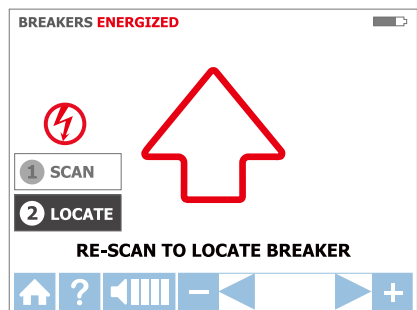

NCV Mode

Receiver:

NCV Mode

The NCV (Non-Contact Voltage) mode is used to verify that a wire is Energized. This method does not require the use of the Transmitter. The Receiver will detect an Energized cable if the voltage is between 90 V and 600 V AC and between 40 Hz and 400 Hz. No current flow is necessary.

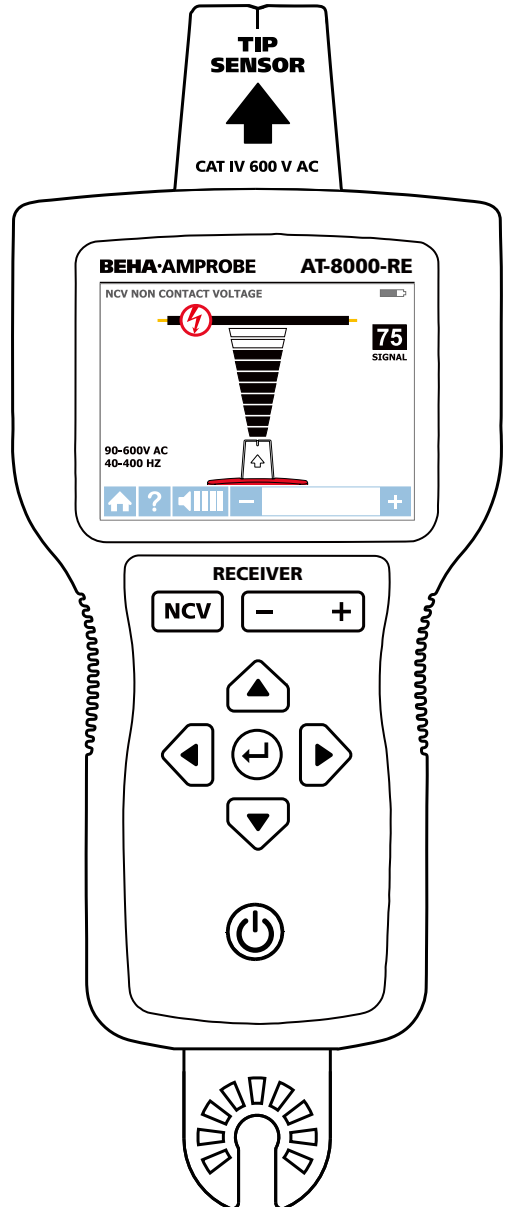

1. **Turn on** the Receiver and press the NCV button.
2. **Hold** the Receiver with the Tip Sensor facing the target area.
3. **Scan** the target area with the Tip Sensor to find the highest signal level, then begin tracing the detected wire. For precise pinpointing of line/phase wire versus neutral wire, increase or decrease sensitivity by pressing + or - on the keypad.
4. **Press ENTER** when complete to return to the home screen.

Note: For safety, before working with wires, always verify that they are De-energized with an additional voltage tester.

Voltage detection in NCV mode using Tip Sensor

Finding Breaks and Opens

1 Set-up: Transmitter

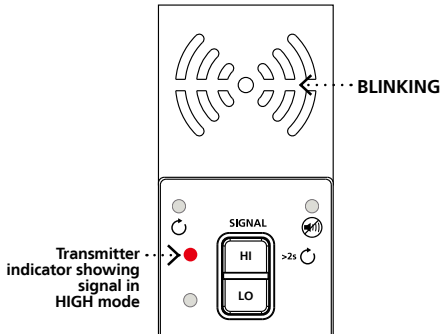

1. **Turn on** the Transmitter.
2. **Verify** that the test leads are properly connected; the red LED voltage status light should be off for De-energized circuits below 30 V AC/DC.
3. **Select HIGH signal mode** by pressing HI.

2 Set-up: Receiver

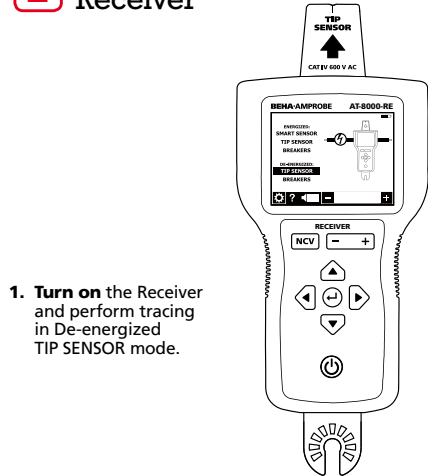

1. **Turn on** the Receiver and perform tracing in De-energized TIP SENSOR mode.

Tracing a cable to find breaks or opens

1. **Start tracing** the cable until the signal stops.
2. **Verify the place of the fault:** move the Transmitter to the other end of the wire and repeat tracing from the opposite end. If the signal stops at the exact same location the fault has been located.

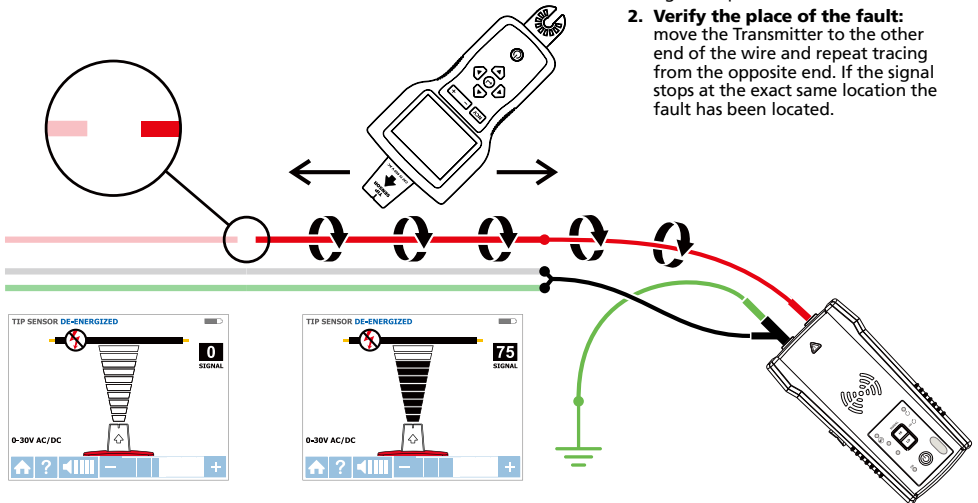

Note: For best results, ground all De-energized wires that run in parallel with the black test lead.

Finding Shorts

1 Set-up: Transmitter

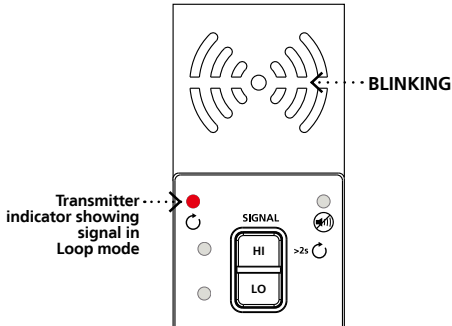

1. Turn on the Transmitter.
2. Verify that the test leads are properly connected; the red LED voltage status light should be off for De-energized circuits below 30 V AC/DC.
3. Turn the Transmitter to Loop mode by pressing HIGH button for two seconds. Verify that the Loop LED is ON.

2 Set-up: Receiver

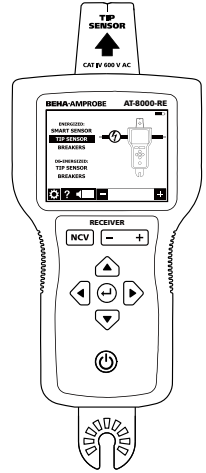

1. Turn on the Receiver and perform tracing in Energized TIP SENSOR mode.

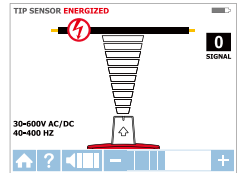
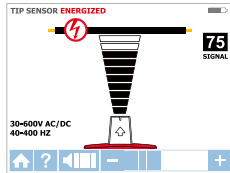
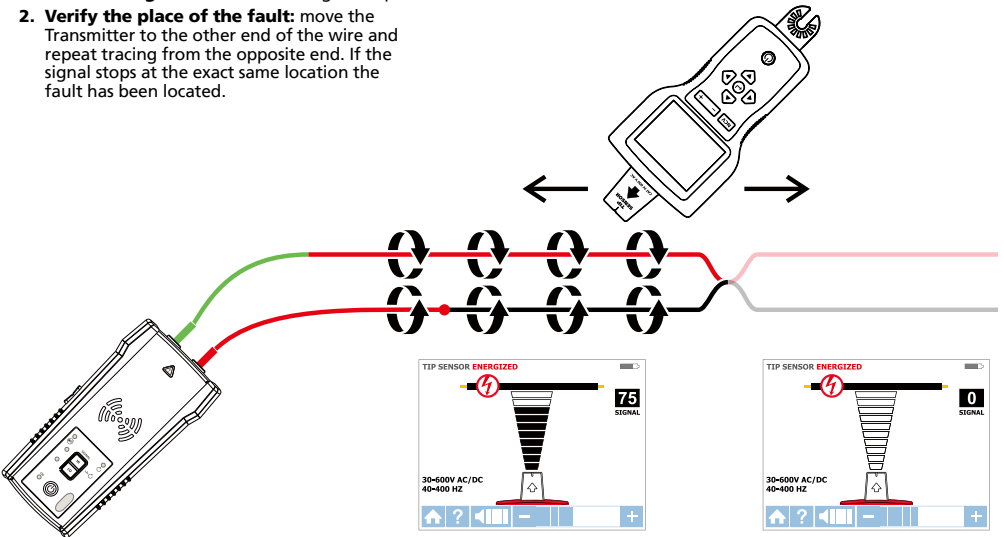

Tracing a cable to find shorts

1. Start tracing the cable until the signal stops.
2. Verify the place of the fault: move the Transmitter to the other end of the wire and repeat tracing from the opposite end. If the signal stops at the exact same location the fault has been located.







Note: This method will be affected by signal cancellation effect. Expect a relatively weak signal.

Specifications

	AT-8000-RE Receiver	AT-8000-TE Transmitter	CT-400-EUR Signal Clamp
Measurement Category	CAT IV 600 V	CAT IV 600 V	CAT IV 600 V, CAT III 1000 V
Operating Voltage	0 to 600 V AC/DC	0 to 600 V AC/DC	0 to 1000 V AC
Operating Frequency	Energized: 6.25 kHz De-Energized: 32.768 kHz	Energized/Loop: 6.25 kHz De-Energized: 32.768 kHz	Loop Mode: 6.25 kHz High/Low Mode: 32.768 kHz AC current measurement: 45 Hz to 400 Hz
Voltage Detection	See NCV detection	> 30 V AC/DC	N/A
Signal Indications	Numeric bar graph display and audible beep	LEDs and audible beep	N/A
Response Time	Smart mode: 750 mSec Tip Sensor Energized: 300 mSec Tip Sensor De-Energized: 750 mSec NCV: 500 mSec Battery monitoring: 5 Sec	Line/phase voltage monitoring: 1 sec Battery voltage monitoring: 5 sec	Instantaneous
Current Output of Signal (typical)	N/A	Energized circuit: HI mode: 60 mA RMS LO mode: 30 mA RMS De-energized circuit: HI mode: 130 mA RMS LO mode: 40 mA RMS Loop mode: 160 mA RMS	1 mA/A for AC current measurement with multimeter
Signal Voltage Output (nominal)	N/A	De-energized circuit: LOW: 29 V RMS, 120 Vp-p HIGH: 33 V RMS, 140 Vp-p Loop model: 31 V RMS, 120 Vp-p	De-energized circuit: 2.4 V RMS, 24 Vp-p
Range Detection (open air)	Smart mode Pinpointing: Around 5 cm (1.97-in) radius (±2%) Direction indication: Up to 1.5 m (5 FT) (±2%) TIP Sensor: Energized Pinpointing: Around 5 cm (1.97-in) (±1%) Detection: Up to 6.7 m (22 FT) (±1%) TIP Sensor: De-Energized Detection: Up to 4.3 m (14 FT) (±5%) NCV (40-400 Hz) Pinpointing: Around 5 cm (1.97-in) radius (±5%) Detection: Up to 1.2 m (4 FT) (±5%)	N/A	N/A
Display Size	89 mm (3.5 in)	LEDs	N/A
Display Dimensions (W x H)	70 x 52 mm (2.76 x 2.07 in)	N/A	N/A
Display Resolution	320 x 240	N/A	N/A
Display Type	Color TFT LCD	LEDs	N/A
Display Color	Yes	Operating mode LEDs: red Battery status LEDs: green, yellow, red	N/A
Booting Time	30 sec	< 2 sec	N/A
Backlight	Yes	N/A	N/A
Operating Temperature	-20 °C to 50 °C (-4 °F to 122 °F)		0 °C to 50 °C (32 °F to 122 °F)
Operating Humidity	45%: -20 °C to <10 °C (-4 °F to <50 °F) 95%: 10 °C to <30 °C (50 °F to <86 °F) 75%: 30 °C to <40 °C (86 °F to <104 °F) 45%: 40 °C to 50 °C (104 °F to 122 °F)		95%: 10 °C to <30 °C (50 °F to <86 °F) 75%: 30 °C to <40 °C (86 °F to <104 °F) 45%: 40 °C to 50 °C (104 °F to 122 °F)
Storage Temperature and Humidity	-20 °C to 70 °C (-4 °F to 158 °F), <95% RH		-20 °C to 60 °C (-4 °F to 140 °F), <95% RH
Operating Altitude	0 to 2000 m (6561 ft)		
Transient Protection	N/A	8.00 kV (1.2/50µs surge)	N/A
Pollution Degree	2		
IP Rating	IP 52	IP 40	
Drop Test	1 m (3.28 ft)		
Power Supply	4 x AA (alkaline or NiMH rechargeable)	8 x AA (alkaline or NiMH rechargeable)	N/A
Power Consumption (typical)	4 x AA battery: 2W	Hi/Lo mode: 70 mA Loop mode with Clamp: 90 mA Consumption without signal transmission: 10 mA	N/A
Battery Life (typical)	Approx. 9 h	Hi/Lo mode: approx. 25 h Loop mode: approx. 18 h	N/A
Low Battery Indication	Yes	Yes	N/A
Fuse	N/A	1.6 A, 700 V, fast-acting, Ø 6x32mm	N/A
Maximum Conductor Size	N/A	N/A	32 mm (1.26 in)
Dimensions (L x W x H)	Approx. 278 x 113 x 65 mm (10.92 x 4.43 x 2.55 in)	Approx. 183 x 93 x 50 mm (7.2 x 3.66 x 1.97 in)	Approx. 150 x 70 x 30 mm (5.9 x 2.75 x 1.18 in)
Weight (batteries installed)	Approx. 0.544 kg (1.20 lb)	Approx. 0.57 kg (1.25 lb)	Approx. 0.114 kg (0.25 lb)
Certifications			

Accessory Specifications

	ADPTR-SCT	TL-8000-EUR
Measurement Category	CAT II	CAT IV 600 V (test leads) CAT IV 600 V (alligator clips) CAT II 1000V (test probes)
Operating Voltage and Current	102 to 253 V AC, 4 A max.	600 V, 10 A max. (red/black leads) 600 V, 6 A max. (green lead) 600 V, 10 A max. (alligator clips) 1000 V, 8 A max. (test probes)
Operating Temperature	0 °C to 40 °C (32 °F to 104 °F)	0 °C to 50 °C (32 °F to 122 °F)
Operating Humidity	≤ 80% RH	95%: 10 °C to <30 °C (50 °F to <86 °F) 75%: 30 °C to <40 °C (86 °F to <104 °F) 45%: 40 °C to <50 °C (104 °F to <122 °F)
Storage Temperature and Humidity	0 °C to 40 °C / 32 °F to 104 °F, ≤ 80% RH	-20 °C to 60 °C (-4 °F to 140 °F), <95% RH
Operating Altitude	0 to 2000 m (6561 ft)	0 to 2000 m (6561 ft)
Pollution Degree	2	2
IP Rating	IP 40	IP 20
Drop Test	1 m (3.28 ft)	1 m (3.28 ft)
Dimensions	Approx. 75 x 50 x 65 mm (2.95 x 1.97 x 2.56 in)	Red/black leads: 1 m (3.28 ft) Green lead: 7 m (22.97 ft) Alligator clips: approx. 95 x 45 x 24 mm (3.74 x 1.77 x 0.94 in) Outlet adapters: 72 x 18 x 18 mm (2.83 x 0.71 x 0.71 in)
Weight	Approx. 0.057 kg (0.125 lb)	Approx. 0.4 kg (0.88 lb)
Certifications	 	 

Included in Wire Tracer Kits

	AT-8020-EUR KIT	AT-8030-EUR KIT
AT-8000-RE RECEIVER	1	1
AT-8000-TE TRANSMITTER	1	1
TL-8000-EUR TEST LEAD AND ACCESSORY KIT*	1	1
CC-8000-EUR HARD CARRYING CASE	1	1
BATTERY CHARGERS	-	3
RECHARGEABLE BATTERIES NiMH TYPE 1.2 V AA (IEC LR6)	-	12
BATTERIES ALKALINE 1.5 V AA (IEC LR6)	12	-
CT-400-EUR SIGNAL CLAMP	-	1
ADPTR-SCT-xx Socket adapter	1	1
HS-1 MAGNETIC HANGER	-	1
USER MANUAL	1	1
QUICK START GUIDE	1	1

*TL-8000-EUR test lead and accessory kit includes:

- 2 x 1 m test leads (red, black): CAT IV 600 V
- 1 x 7 m test lead (green): CAT IV 600 V
- 2 x Alligator clips (red, black): CAT IV 600 V
- 2 x Outlet blade adapters (red, black): CAT II 300 V
- 2 x Outlet round adapters (red, black): CAT II 300 V

Optional accessories:

HS-1 Magnetic hanger
TL-8000-25M Test lead
CT-400-EUR Signal clamp



Beha-Amprobe®

Division of Fluke Corp. (USA)
c/o Fluke Europe BV

In den Engematten 14
79286 Glottertal, Germany
Tel. +49 (0) 7684 - 8009-0
info@beha-amprobe.de
beha-amprobe.de

Science Park Eindhoven
5110 NL-5692 EC Son
The Netherlands
Tel. +31 (0) 40 267 51 00
beha-amprobe.com

52 Hurricane Way
NR6 6 JB United Kingdom
e-mail: info@beha-amprobe.co.uk
beha-amprobe.com