

ThunderSync3-C10

User Manual

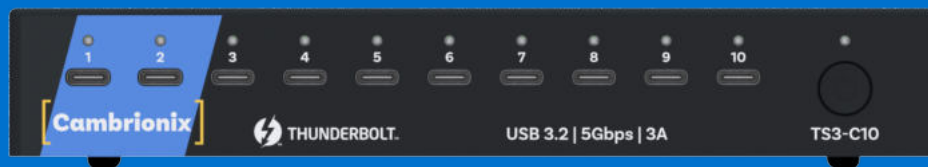

1. Table of Contents

1. Table of Contents	1
2. Your ThunderSync3-C10 at a glance	3
2.1. Key Features	3
3. Safety	4
3.1. Signal word panel	4
3.2. Safety alert symbol	4
3.3. Pictograms	5
3.4. Product modification	5
3.5. Power supply	6
3.6. Storage and Installation	6
3.7. Cleaning your ThunderSync3-C10	7
4. Getting Started	9
4.1. Unpacking your product	9
4.2. What's Included	9
4.3. Consumables and Placing Orders	9
4.4. Connecting to the mains	10
4.5. Connecting to a Host	10
4.6. Connecting devices to your ThunderSync3-C10	10
4.7. Charging	11
4.8. Registration	11
4.9. Help and Support	11
5. Using your ThunderSync3-C10	12
5.0.1 Port LED States	12
5.0.2 Fan Behaviour	12
5.1. Using without connecting to a host	12
5.2. Using when connected to a host	12
5.2.1 Connecting the Hub to a host computer	12
5.2.2 Authorising Thunderbolt™ hubs on Linux®	13
5.2.3 Charging	13
5.2.4 Data Transfer	14
5.2.5 Communication Interface and Protocol	14
5.3. Scalability	16
5.4. Managing Ports & Your ThunderSync3-C10	17
5.4.1 Port Modes	17
5.4.2 Switching port modes	17
5.4.3 Charging Profiles	17
5.4.4 Firmware	17
6. Software	20
6.0.1 Installing Software	20
6.0.2 Cambrionix Connect	20

6.0.3 Cambrionix Hub API	22
6.0.4 Updating Software	22
6.0.5 Removing Software	23
6.0.6 Command Line Instructions (CLI)	24
7. Product Specifications	25
7.1. Features	25
7.2. TS3-C10 Specifications	25
7.3. Power Specifications	27
7.4. Port Specifications	28
7.5. Drawings	30
7.6. Product Label	31
7.7. Hub Architecture	32
8. Troubleshooting	34
8.1. Common troubleshooting tips	34
8.2. Logging through Cambrionix Connect	34
8.3. Hardware Failure	35
8.4. Device connection	35
8.5. Hub connection issues	37
8.6. Using with a headless system	37
8.7. Software troubleshooting	37
9. Returns and Damaged Products	39
9.1. What if my order arrives with an issue?	39
9.2. What happens after I have requested a Return?	39
10. Compliance and Standards	40
10.1. EU RoHS Compliance	41
10.2. Bis Certification	42
10.3. UL Certification	43
10.4. Waste Electrical and Electronic Equipment (WEEE)	44

2. Your ThunderSync3-C10 at a glance

The ThunderSync3-C10 has been designed to provide high-speed data transfer to USB compliant devices and expand the endpoint limits.

The ThunderSync3-C10 can charge attached USB devices without using a local computer. The ThunderSync3-C10 allows any USB compliant device to be charged at its optimum rate (up to 3A). The firmware can be updated to ensure the ThunderSync3-C10 can manage the latest devices. It is ready to charge out-of-the-box and sync devices when attached to a host computer.

When a local (host) computer is attached, the host can control the operation of each port using software provided by Cambrionix. Device charging and synchronisation can be monitored through Cambrionix’s Connect Application, the Application Programming Interface (API) or Command Line Interface (CLI). Cambrionix’s monitoring and control software can be downloaded from <https://www.cambrionix.com/software>

With your ThunderSync3-C10 there is a Thunderbolt™ 3 connection to the host capable of up to 5 Gbps. The upstream data transfer rate will be shared amongst the downstream connections.

2.1. Key Features

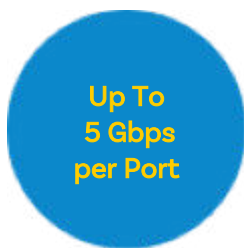

Transfer Data Seamlessly

Each high-speed port can transfer data up to 5 Gbps



Power

Each port can charge devices up to 3 A at 15 (W)



Scalability

Up to 47 devices can be connected at once using multiple hubs

3. Safety

This user manual is for informational purposes only, it contains information for the start-up and operation of this product. Note: the contents and the product described are subject to change without notice. To avoid injuries and damage, observe the safety instructions in the user manual.

This manual has been arranged to follow the IEC/ICEE 82079-1 standard. This is to facilitate the easier understanding and location of information relating to the ThunderSync3-C10. Any errors or omissions can be reported using our support ticket system (see [Help and Support](#)). This way, any issues that are discovered can be acted on quickly and we can update the documentation to reflect this.

Understanding and observing the instructions in this user manual are prerequisites for hazard-free use and safety during operation. This user manual cannot cover all possible applications. If you would like additional information or if problems arise that are not sufficiently addressed in this manual, please ask your distributor or contact us directly using the means preferred, which are located on the back cover of this manual.

	⚠ CAUTION
	<p>Personal Injury and Damage to the product</p> <p>Always observe the safety instructions in this user manual</p>

3.1. Signal word panel

Depending on the probability of serious consequences, potential dangers are identified with a signal word, the corresponding safety colour, and if appropriate, the safety alert symbol.

⚠ CAUTION
<p>Indicates a potentially hazardous situation that, if not avoided, may result in moderate or minor (reversible) injury.</p>



CAUTION
<p>Indicates a potentially hazardous situation which, if not avoided, may result in damage to the product and its functions, or to property in its proximity.</p>



3.2. Safety alert symbol

	<p>Use of the safety alert symbol indicates a risk of injury.</p>
<p>Observe all measures that are marked with the safety alert symbol in order to avoid injury</p>	

3.3. Pictograms

These symbols will be used throughout this documentation to alert to any potential dangers or any actions that must be taken.

Warning Signs	
 Electrical hazard	 Fire Hazard

Mandatory action signs	
 Read operating instructions	 Mandatory regulation

3.4. Product modification

Cambrionix products are designed and manufactured to meet the requirements of UK and international safety regulations. Modifications to the product could affect safety and render the product non-compliant with relevant safety standards, resulting in injury or damage to the product.

	⚠ CAUTION
	<p>An electric shock or personal injury may occur</p> <p>Do not modify the product in any way. Do not dismantle the product. Do not open the product</p>

	⚠ CAUTION
	<p>Fire, or personal injury may occur</p> <p>Do not obstruct air vents on the product. Do not cover the product in or place near combustible material.</p>

	CAUTION
	<p>Damage to your product may occur</p> <p>Do not bend or compress any part of the product.</p>

3.5. Power supply

This section describes the safety precautions you must follow when using the external power supply.

	⚠ CAUTION
	<p>An electric shock or personal injury may occur</p> <p>Do not use a damaged power cord or plug, or a loose power socket. Do not touch the power plug with wet hands. Do not allow liquids to come into contact with the unit or power supply.</p>

	CAUTION
	<p>Damage to your product may occur</p> <p>Do not short circuit the Power Supply Unit (PSU) supplied with your product. Do not disconnect the power cord while the product is being used. Do not bend or pull the power cord with excessive force. Do not use a power supply that exceeds the power supply specifications within this manual</p>

3.6. Storage and Installation

This section describes safety precautions you must follow when installing and storing your ThunderSync3-C10.

	⚠ CAUTION
	<p>An electric shock or personal injury may occur</p> <p>Do not place the power cord near heat sources. Connect the plug only to an earthed socket.</p>

	CAUTION
	<p style="text-align: center;">Damage to your Cambrionix product may occur</p> <p style="text-align: center;">Operate the product only in an environment where the ambient temperature is inside the operating temperature range. Operate the product only in an environment where the relative humidity is inside the operating range. Be careful not to leave the power cord underneath a heavy object.</p>

	⚠ CAUTION
	<p style="text-align: center;">Overheated power sockets may cause a fire</p> <p style="text-align: center;">Do not overload the power socket that your hub is connected to. Insert the power plug all the way into the socket so that it is not loose.</p>

	CAUTION
	<p style="text-align: center;">Overloading the brackets may cause failure</p> <p style="text-align: center;">The rack brackets for all our products are not designed to be used in a mobile application, bracket failure could occur if the units are not supported fully e.g Shock during road transport.</p>

3.7. Cleaning your ThunderSync3-C10

Cleaning the product is generally not required, although in some instances it may be necessary if excess dirt/ dust/ hair has accumulated, or if minor liquid spillages have occurred on the module during operation or storage.

	⚠ CAUTION
	<p style="text-align: center;">Electric shock or personal injury may occur</p> <p style="text-align: center;">If there is a dirt/ spillage over a ventilation slot, external data/ power connector or product aperture, please remove power from the unit without touching the liquid and seek advise before reapplying power</p>

- Ensure that the product is switched off and the power cord is removed from the product. Hold the power cable by the plug and do not touch either the plug or the power cord with wet or damp hands as an electrical shock may result
- Wipe the product with a clean, dry and soft cloth. Do not use detergents which contain alcohol, solvent or surface-active agents. Do not spray water or detergent directly onto the product
- Mildly dampen a soft and dry cloth in water and wring thoroughly to clean the product as required
- Dry the product thoroughly once the cleaning has finished
- Reconnect the power cord and use your product as advised once cleaning is complete

4. Getting Started

This manual provides a reference for end-users installing for the first time and using their hub afterwards. As well as a guide for product safety-related information.

The ThunderSync3-C10 is intended to be used in an indoor static environment in which the environment falls within the tested specifications to provide charge, sync and management functionality. Please see the [Product Specifications](#) section of this manual for information on the environment specifications.

4.1. Unpacking your product

When you have received your product, please check the packing slip inside the box to ensure all contents and quantities are correct before opening. This is to avoid retesting and repackaging any items that are not required.

When opening the packaging, use a suitable method to open the box i.e, do not use a knife. This is to ensure the product is not damaged.

	⚠ CAUTION
	<p>Personal Injury and Damage to the product</p> <p>There will be a label on the hub advising you to read the User manual before use. This will need to be removed before use as it may be covering host ports, vents etc.</p>

4.2. What's Included

- Thunderbolt™ 3 Cable (to provide communication between the host system and hub)
- ThunderSync3-C10 Hub
- 2m Mains power cable (Country specified on order including fuse for the UK plugs)
- Power Supply Unit

4.3. Consumables and Placing Orders

If you require any spare parts, such as the power cable or Thunderbolt™ 3 cable, these can be ordered by quoting the product part number listed in the [Product Specifications](#).

These can be ordered from the reseller or solution partner you purchased your ThunderSync3-C10 from, or from Cambrionix directly.

To find one of our partners local to you please visit www.cambrionix.com/partners where you can learn about the local vendors and distributors that can assist you and find their contact information.

4.4. Connecting to the mains

Connect the Power Supply Unit (PSU) to the hub using the 4-Pin Mini-DIN plug. Connect the power cable to the PSU. Making sure you adhere to local safety regulations, connect the power cable to the 100 - 250 VAC mains power outlet and switch the hub on using the small power switch located adjacent to the power input connector on the hub. When the device is switched on, a green LED next to the power input will be illuminated. The hub is now ready to charge attached devices.

Periodic inspections should be made to power supply cables and any USB cables for any signs of damage. If any damage is found, replace the damaged cord before further use.

4.5. Connecting to a Host

Throughout this manual we will refer to a "host system" this is the system you will be using to connect and control your devices and hubs. This could be any host system such as a Windows PC, macOS system or Linux PC.

Once the power is connected, connect the ThunderSync3-C10 to your host system using a Thunderbolt™ 3 cable. Using an incorrect host cable may result in the hub and all subsequent ports not being recognised by your host.

Cambrionix recommend using the Thunderbolt™ cable that is provided with our ThunderSync3-C10. If you are looking at purchasing your own cable, to achieve 40 Gbps a suitable cable would be either:

- up to 0.8m passive
- up to 2m active.

Cambrionix recommend using cables certified by Intel®, all cables marked with the Thunderbolt™ logo should have certification.

Only one host can be connected to a hub at one time, and only one cable will be required to connect to the host system.

Please note that USB specifications require a minimum 100 mA charge current to be available during data transfer. As indicated in above, if the attached device has a BC1.2 compliant CDP port, the device can draw up to 3A whilst transferring data.

4.6. Connecting devices to your ThunderSync3-C10

Throughout this manual we will refer to "devices" this relates to the device you are connecting to the ThunderSync3-C10 this could be any USB device such as a phone, tablet, USB drive or any other USB connected device.

Once you have your hub setup the next thing is to connect your devices to start using the ThunderSync3-C10. We would always recommend using the OEM cable supplied by the manufacturer of the device, so whatever cable is provided with the device use that cable to connect to the hub.

If your device has a USB plug (male connector) on it already then you can connect the device directly into the hub.

If the cable (or plug fitted to device) is not the same USB type as the socket (female connectors) on the ThunderSync3-C10 then you will require an adaptor or a different cable.

Cables

Some USB cables are data transfer only, and some are power delivery only. There are also options that can handle both tasks. Be sure to verify a cable's abilities before purchasing it and select a cable which can handle the speeds and power transfer that you require.

4.7. Charging

Your ThunderSync3-C10 will allow your device to charge at the maximum rate possible up to 3A. The way that charging takes place is the ThunderSync3-C10 will provide the device with a capability to charge and the devices USB charging controller will determine the maximum amount of charge it wants to draw down.

Although a maximum charge rate of 3A is possible, the device itself determines the exact rate and as such you may not see the maximum amount of charging on every device type that is connected.

4.8. Registration

You may register your product at www.cambrionix.com/product-registration

4.9. Help and Support

FAQs and help can be found on the Help page here

- www.cambrionix.com/help_pages/help.

You can raise a support ticket for more in depth support here

- <https://support.cambrionix.com>

You can also download any of our manuals and keep up to date at the link here

- www.cambrionix.com/product-user-manuals

When contacting support, please supply the product information for the hub in question. This can be found on the Device Information Plate which is either on the underside or back of the unit.

Providing serial and Purchase order numbers, can help identify your specific product and speed up the process.

5. Using your ThunderSync3-C10

In this section, you can find information using your hub in charge or sync application. You can also find information on managing your hub, changing port modes, connecting multiple hubs to one host and using Cambrionix Software.

5.0.1 Port LED States

Your ThunderSync3-C10 has inbuilt LEDs used to show the state of the ports, devices and the power state. These LEDs can be configured to support your use case; this can be controlled either by using the API to send commands directly or through separate software. When the hub is powered on all the available LED's will flash once and then revert to the default behaviour mentioned below.

Colour	Behaviour
Solid Green	Device connected and port is on
Yellow	Hub is resetting
Red	Fatal error
LED Off	No Device is detected

Table 5-1

5.0.2 Fan Behaviour

Your ThunderSync3-C10 has an inbuilt fan used to cool the product when internal temperatures rise above a set threshold. On power up the fan will spin for approximately a second before turning off. For more information on the temperatures that trigger the fan please see the fan properties section in the [TS3-C10 Specifications](#).

5.1. Using without connecting to a host

When the Hub is switched on and is not connected to a local host computer it is automatically configured to charge devices using its intelligent charging algorithm. Connect the devices to be charged to any of the available ports (not the Host Port) using USB - compliant cables.

5.2. Using when connected to a host

5.2.1 Connecting the Hub to a host computer

You can use either Thunderbolt™ host port on the rear of the hub to connect to your host system; there are two ports on the rear, so you can use one port to connect the host and the other port to daisy chain multiple hubs.

Connect the ThunderSync3-C10 to your host system using a Thunderbolt™ 3 cable. Using an incorrect host cable may result in the hub and all subsequent ports not being recognised by your host. You can use an optical cable to connect to your host as the ThunderSync3-C10 is self powered.

5.2.2 Authorising Thunderbolt™ hubs on Linux®

With Linux® systems, it is necessary to authorise/enrol the ThunderSync3-C10 before it connects.

To do this, you will need to use "boltctl," which is used to control the Thunderbolt™ device manager. "boltctl" is the command-line interface to interact with boltd, the system daemon that manages Thunderbolt™ 3™ devices. Using "boltctl", input the following commands to authorise and enrol your ThunderSync3-C10.

Some useful information on this can be found at the following link.

<https://manpages.ubuntu.com/manpages/focal/en/man1/boltctl.1.html>

power [-t | --timeout seconds]

Power up the Thunderbolt™ controller. If the Thunderbolt™ controller is not in "native enumeration mode", it can be completely powered down by the host firmware/BIOS. On supported systems, there is an interface to "force" power the Thunderbolt™ controller. If supported, this command will request the daemon to do so. The daemon will keep track of all client requests and will release the force power override when the last request is released.

authorize DEVICE

Authorize a currently unauthorized device identified via its unique id (uuid) DEVICE. If a key is stored in the database, it will be used, given the security level of the domain supports secure device connection. Use boltctl list to find out the uuid of a device.

enrol [--policy default] DEVICE

Authorize and record the device with the unique id DEVICE in the database. If the domain supports a secure connection a new key will be generated and stored in the database alongside the device and vendor name. The key, if created, will be used in the future to authorize the device securely.

5.2.3 Charging

When the Host Port is connected to a local computer, the hub defaults to Sync mode and charge currents are determined according to USB Implementers Forum (USBIF) Super-Speed USB3 specifications. If the attached device complies with USB-IF Battery Charging specification BC1.2 and supports Charging Downstream Port (CDP), the hub can provide high-speed charging at 3A. If the connected device does not comply with BC1.2, the charge current will be limited to 0.9A in compliance with USB specifications.

If you wish to limit the charging to your devices whilst connected to your host system then you can disable CDP. You can disable CDP through Internal hub settings either by going through the advanced settings and turning "Sync charge" off or through the API and disabling it via code. For example, the instructions would be below using the command line.

The CLI commands for turning off the sync charge options, with a 1 or 0 per port.

```
settings_unlock
settings_reset
settings_set sync_chrg 0 0 0 0 0 0 0 0 0 0 0 0 0 0 0
settings_set alt_sync_chrg 0 0 0 0 0 0 0 0 0 0 0 0 0 0 0
reboot
```

This can also be done via the API if this is easier. Just supply that string (joined with \n) like:

```
cbrxapi.cbrx_connection_set(handle, "Settings", "settings_unlock\nsettings_reset\nsettings_set sync_chrg 0 0 0 0 0 0 0 0 0 0 0 0 0 0 0\nsettings_set alt_sync_chrg 0 0 0 0 0 0 0 0 0 0 0 0 0 0 0\nreboot")
```

Note that settings_reset clears any previous settings, so if you need to retain something else, it would be better to issue settings_display first, which gives you the entire settings which you can then modify and re-issue in entirety.

5.2.4 Data Transfer

If you wish to transfer data, change applications, restore or update your mobile device, a data connection to a local host computer is required. The Cambrionix Hub API and software is compatible with macOS®, Windows™ and Linux® operating systems and can transfer data between these operating systems and many mobile operating systems such as iOS™ and Android™.

In order to transfer data, connect the host port to your local (host) computer using a Thunderbolt™ 3 compliant cable. Any devices connected to the hub will now appear as if they were connected to the host computer’s USB port.

To transfer data, connect the Thunderbolt™ port of your local (host) computer to one of the Thunderbolt™ ports on the back of the hub using a Thunderbolt™ 3 compliant cable (Thunderbolt™ 4 cable is backwards compatible). A Thunderbolt™ 2 cable with a Thunderbolt™ 2-3 adaptor can also be used with reduced data speeds. Any devices connected to the hub will now appear connected to the host computer’s USB port. The hub fully complies with SuperSpeed USB 3.2 and can provide up to 5Gbps data transfer speeds per port. A blue LED above each port will illuminate when Syncing. You can use the program of your choice to transfer data to and from your device.

5.2.5 Communication Interface and Protocol

The ThunderSync3-C10 appears as a virtual COM port (VCP). On Microsoft Windows™, the system will appear as a COM port, the COM port number can be found in device manager. On macOS®, a device file is created in the / directory. S is an alpha-numeric serial string unique to each device

```
/dev/tty.usbserial S
```

Devices incorporate a USB to UART converter IC from FTDI International. On Windows 7 or later, a driver may automatically be installed (if Windows is configured to download drivers from the internet automatically). If this is not the case, or if a Mac® or Linux® platform is used, the driver may be downloaded from www.ftdichip.com. The VCP drivers are required. For Linux® or Mac computers, the default OS drivers should be used.

The default communications settings are as below, ANSI terminal emulation should be selected.

Communication setting	Value
Number of bits per second (baud)	115200
Number of data bits	8
Parity	None
Number of stop bits	1
Flow control	None

Table 5-2

5.3. Scalability

If you wish to maximise the amount of devices you can connect through one USB port on your host system it is possible to connect multiple hubs together.

To daisy-chain multiple hubs, each hub needs to be connected to mains power individually, then the first (parent) hub in the chain should be connected using the host port and then connecting directly to a USB port on the host system. The subsequent hubs can then be connected using the host port on the second (child) hub and the expansion port from the parent hub.

If you connect too many devices to most computers' USB ports, you may hit what is known as the endpoint limit.

If you experience the endpoint limit, you are likely to see an error indicating you have “run out of USB resources” on your host computer, you may not see any error message at all, and (any of) your USB devices may randomly fail to operate correctly or become intermittent.

For more information on endpoints, connecting multiple devices and calculating how many devices you can connect to your host system please see our technical note on endpoints.

<https://downloads.cambrionix.com/documentation/en/Technical-note-endpoint.pdf>

Each USB device will use a different amount of endpoints and therefore a different amount of endpoint memory. This will need to be looked at on a case by case basis, you can find information on different products and how to calculate from our technical note linked above. Also another thing to consider when connecting devices is how you are connecting them, for example using a USB2 cable with a USB3 capable device will only connect the device with USB2.

You will also need to consider hub depth when chaining multiple hubs, more information can be found in the technical note.

Examples

Using the ThunderSync3-C10 you will be able to connect the following amount of devices. It is possible to connect more devices and hubs but as a baseline this amount of devices should always be possible to connect at one time.

Device	Maximum numbers of devices connected via USB 2	Hubs required	Maximum number of devices connected via USB 3	Hubs required
Google Pixel 6	47	5	30	3
iPhone 13	19	2	N/A	N/A
Samsung S20	19	2	10	1
Oppo X2 Lite	47	5	N/A	N/A
Xiaomi Redmi 9AT	47	5	N/A	N/A

5.4. Managing Ports & Your ThunderSync3-C10

Each port on your ThunderSync3-C10 can be managed either individually, or all together. You can turn the ports off and on, change the port mode, or change various other settings applicable to the ThunderSync3-C10 more information can be found in the [Cambrionix Connect](#) section under Internal hub settings. This can be done through Cambrionix Connect, the CLI or by connecting to the hub via the API.

5.4.1 Port Modes

Sync	Turn specific ports or the whole hub to sync mode
Off	Turn specific ports on or off or switch the whole hub on or off (no power and no data channels open, mimics unplugging the device)

Table 5-3

5.4.2 Switching port modes

You can switch between port modes by using Cambrionix Connect, the CLI or by connecting to the hub via the API. If you switch a port off then this will stop any connection taking place to the USB device and would mimic unplugging the USB device completely from the host system.

You can disable CDP through Internal hub settings either by going through the hub settings and turning "Sync charge" off or through the API and disabling it via code. For example, using the command line, the instructions would be as below.

```
settings_unlock
settings_set sync_chrg 0000000000000000
```

5.4.3 Charging Profiles

To ensure attached devices charge at their optimum rate, our smart USB hubs come with the below intelligent charging profiles built in:

1	900mA
2	1.5A
3	3A

Table 5-4

5.4.4 Firmware

The firmware can be kept up to date using our Cambrionix Connect software. As part of delivering an easy user experience, our Cambrionix Connect application is now a set-and-forget solution. The Cambrionix Connect application will discover your USB hub's firmware and present an update for you.

To update the firmware, first, go to the firmware section of Cambrionix Connect. Here you can see the available Firmware versions to install to the hub.

The current firmware version on the hub is displayed in the firmware section alongside the hub's name. This will appear red if a newer version is available or green if it is the most up to date.

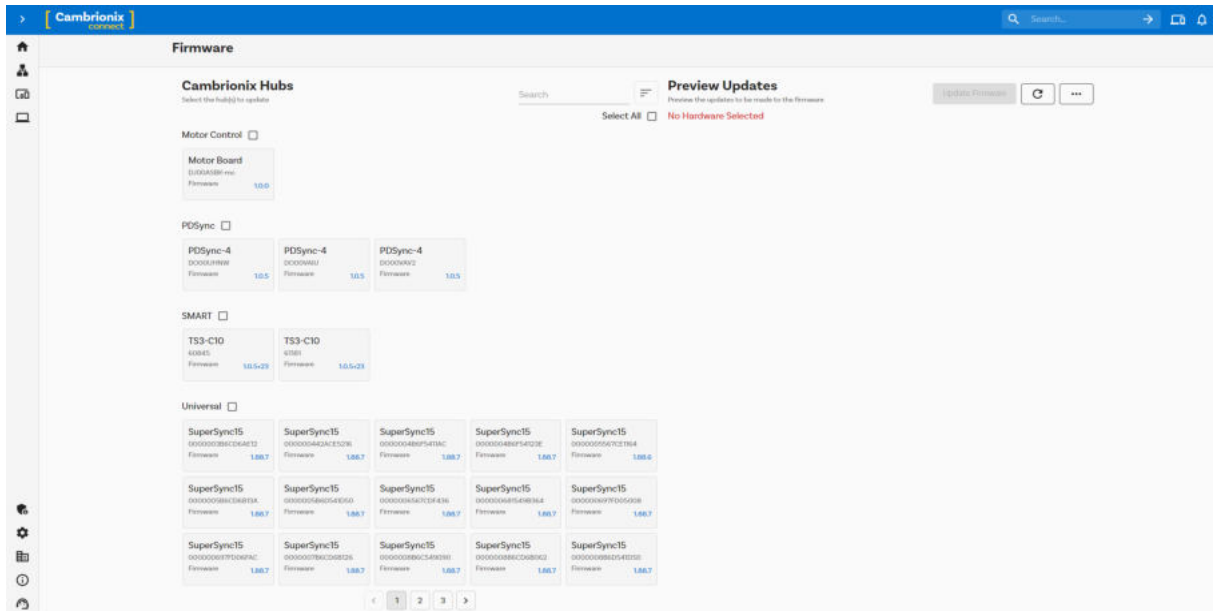

Figure 5.1

To install the firmware onto the hub click the hub(s) connected that you want to update, the latest firmware will be automatically selected, if you wish to change the firmware version you are updating to then this can also be done. Once selected press the update button at the top and the update will commence.

	CAUTION
	<p>Your ThunderSync3-C10 may not function correctly</p> <p>Do not downgrade firmware onto a new product</p>

	CAUTION
	<p>Your Cambrionix Firmware may get corrupted</p> <p>Do not interrupt the Firmware update process. Do not disconnect the power during the update process.</p>

CAUTION

A new version may be available

Ensure you have the latest version of Firmware installed on your hub. These updates will often contain new features, fixes for bugs and performance improvements

6. Software

Cambrionix provides interfaces by which the Hub can be monitored and managed:

- Cambrionix Connect
- Cambrionix Hub API
- Command Line Instructions

Cambrionix connect can use the API to interact with the devices through a user-friendly application, or the API can be used to provide other protocols that send translated string commands. The ThunderSync3-C10 uses string commands to communicate with the host system. These can be sent via the virtual serial port of the ThunderSync3-C10 directly,

There are different channels for both our Cambrionix Connect application and the API. The channels are Beta and Release. We would recommend using the release version of both the API and Cambrionix Connect.

We will push bug fixes and updates through Beta before it is merged into the Release version. If you have found a bug that we have a fix for, the Beta releases may already have addressed these and implemented fixes.

6.0.1 Installing Software

Cambrionix has software that can be used to manage the devices and your hub using different host systems. This section has instructions and information on using our software on three of the most popular host systems.

Our software is available to download from www.cambrionix.com/software, you will find software available for Windows™, Mac® and Linux® Systems.

Linux® OS systems tested with our software are Ubuntu 18.04 LTS or Debian 9; some other OS versions based on the two mentioned will work. Some different Linux® OS versions may work, but we dont test against other distributions.

To install on Mac® and Windows™ systems, download the install files from the above link, once downloaded run the install process and dialogue boxes will help you through installation and initial set-up.

For Linux® systems, download the install files from the website at the above link. Once downloaded, you can either install it from the desktop GUI or the command line via:

```
sudo apt install ./
```

after this command you will need to enter the file name that has just been downloaded from our website.

6.0.2 Cambrionix Connect

Cambrionix Connect is an application that can be run from a browser by visiting connect.cambrionix.com or it can be downloaded from www.cambrionix.com/connect. Cambrionix Connect allows you to switch the ports on and off and set the port mode. Cambrionix Connect's

home page shows the hubs available, by selecting a hub you can obtain the following information about all the ports:

- Status (Attached/disconnected)
- Mode (Charge/Sync/Off)
- Profile (Charging profile)
- Duration (How long the device has been attached)
- End time (Time the battery reaches a threshold (full) level)
- Current (Quick charge current in mA)
- Energy (Present energy rate)

Tick boxes adjacent to each port symbol allow that port mode to be changed when the "enable port controls" is selected. Cambrionix Connect shows the hub rail voltages, time since switched on, total current and power, and temperature. Further details on Cambrionix Connect are available on our website. www.cambrionix.com/connect

Internal hub settings

Within your hub, there are some specific controllable settings called 'internal hub settings'. These are a variety of different settings for your ThunderSync3-C10.

You can navigate to the Internal hub settings by opening Cambrionix Connect and selecting the hub you want to connect to. Once you have chosen the connected hub, navigate to the below icon on the top right of the screen from Cambrionix Connect



Figure 6.1

Once you have pressed this you will be taken to the Internal hub settings section where you can view and change the Internal hub settings, including reverting back to default factory settings.

Setting name	Description	Default value
Friendly Name	Optional, "Friendly Name", set by the user. Limit of 31 characters. This name will appear in the device's system information if set.	Empty
Attach Threshold (mA)	The attach threshold is the device current (mA) level at which the hub can determine that a device (iPhone etc.) has been attached to a port. The attach threshold may need to be increased if the device (iPhone etc.) is connected to a Cambrionix port with a cable which includes an LED or other electronics. It may also need to be increased if you are using a device (iPhone etc.) with a 3rd party sled/holder/case (such as a barcode scanner or battery pack) which contains electronics or charging pass-through	10

Table 6-1

*Charging Downstream Port (CDP) Being enabled means that a port is capable of transferring data and charging the device at the same time with a higher current than just data syncing alone. With CDP enabled the hub can supply up to 1.5A

If you disable CDP you will receive the notification “This Hub has the Charge Downstream Port UCS mode disabled. This could limit the maximum current seen on some ports.” This notification is there to ensure you havent turned this off by accident and can still have the highest charge available.

There is more information on the Internal hub settings and how to manage them in our CLI manual. which can be found at the link [here](#).

	CAUTION
	<p>A new version may be available</p> <p>Ensure you have the latest version of Cambrionix Connect installed on your host system. These updates will often contain new features, fixes for bugs and performance improvements</p>

6.0.3 Cambrionix Hub API

The Cambrionix Hub API allows you to monitor and control each port in detail and to integrate these functions into your own workflow processes. The API comprises a daemon (which is a program running in the background) that can be downloaded from www.cambrionix.com/products/api and installed on the host machine. Port information and control can be provided through the API. Calls are sent as a request to the API to “Get” port, device or Hub information, or “Set” port functions. A library of sample code is downloaded along with the API from the following link www.cambrionix.com/products/api and can be found within the program files under 'examples'. These can help you integrate many of these functions into your process work-flow alongside the complete user manual.

	CAUTION
	<p>A new version may be available</p> <p>Ensure you have the latest version of API installed on your host system. These updates will often contain new features, fixes for bugs and performance improvements</p>

6.0.4 Updating Software

By using Cambrionix Connect you will be able to automatically download and install the most up to date software (Cambrionix Connect and the Cambrionix Hub API)

By going into the settings section on the left-hand side of Cambrionix Connect, you can navigate to the general tab, and under this can see the options for keeping both Cambrionix Connect and the API up to date.

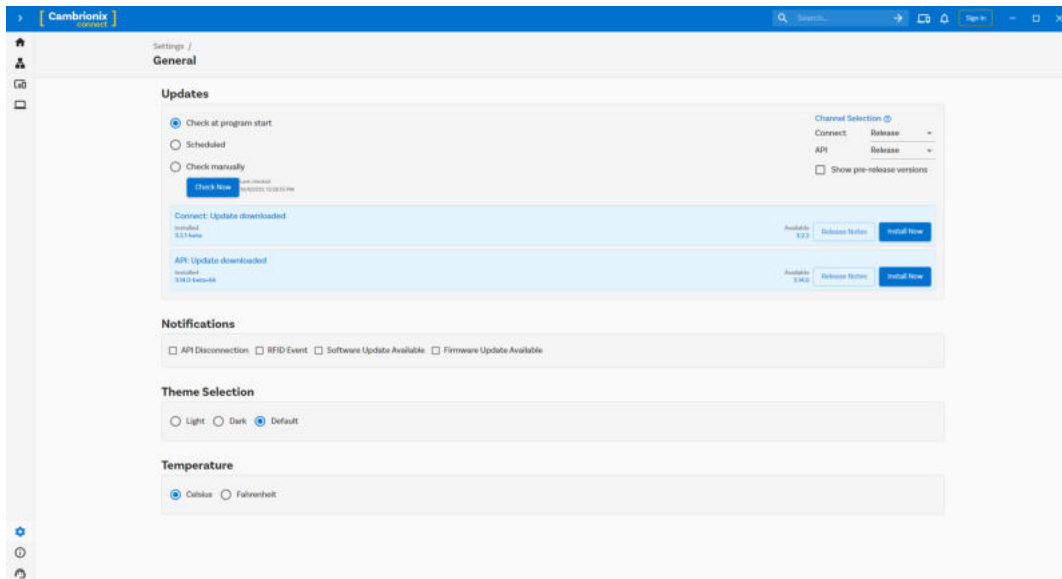

Figure 6.2

By default Cambrionix Connect will check for updates regularly or, if you prefer, you can change to a manual update selection. You can also select which version of the software you would like to use between the Beta or Release options. You can also select historic versions of the API and Cambrionix Connect to install.

When you have some software updates available, you can select install now to begin the installation process; a progress bar will appear to show the installation status. From this bar, you can also view the release notes for the version of the software you are looking at.

6.0.5 Removing Software

If you wish to uninstall the software (Cambrionix Connect, Cambrionix Hub API and the Cambrionix Recorder Service) from your host system, the following steps can do this.

Windows™

To remove the software from a Windows™ system, you can do so by going into "Add or remove programs" finding the software you wish to remove, selecting it and pressing "uninstall"

macOS®

To remove the software from a macOS® system, locate the application in the Finder, drag the application to the Trash, or select the application and choose File > Move to Trash. You may be asked to enter the name and password of an administrator account on your Mac®. Then to completely delete the application, choose Finder > Empty Trash.

Alternatively, use the below instructions.

```
sudo /Library/Cambrionix/ApiService/bin/CambrionixApiService --remove
sudo /Library/Cambrionix/ApiService/bin/CambrionixRecorderService --remove
```

Linux®

To remove software on Linux® there are two options.

The first is to use the Software centre, then either the list of installed applications or the search bar to find the software you wish to remove. Once you have selected the application, click on the remove button and you will be prompted for a password, enter the password and the software will be removed.

The second way you can remove software is by using the command line. All you need to do is to use the command in the following fashion:

```
sudo apt remove program_name
```

Table 6-2

Variable	Description
<i>program_name</i>	The file name of the program including any version numbers

You'll be asked to enter your account password. When you enter it, nothing is visible on the screen. You will need to confirm removal, it will ask for your confirmation, press the enter key or Y key: Keep in mind that you'll have to use the exact package name in the apt remove command otherwise, it will show 'unable to locate package error'. You can type the first few letters of the program you want to uninstall, and then hit the tab key. It will show all the installed packages that match those letters at the beginning of their names.

6.0.6 Command Line Instructions (CLI)

Command Line Instructions can be used to control and monitor the functions of the hub and attached devices. To use the command-line interface a serial terminal emulator must be installed on the host computer. Examples include PuTTY, Serial, ZTerm, and Minicom. If you would like more information, please look at our more in-depth information here: www.cambrionix.com/cli

Two example commands can be seen below, you can use these commands to check hub information and health.

Command	Action
system	Show hardware and firmware information
health	Show voltages, temperatures, errors and boot flag

Table 6-3

7. Product Specifications

7.1. Features

TS3-C10 Features	
19-inch Rack Mountable	no
Dedicated control port	no
Fan Assisted Cooling	yes
Selective upstream port	no
Internal Temperature Monitoring	yes
Indicator LED	yes
User Replaceable Fuse	no

Table 7-1

USB Downstream Port Features	
Configurable enumeration delay	yes
USB BC 1.2 Support	yes
USB Type-C Rev 1.3 Support	yes
USB Power Delivery 2.0 Support	no
USB Power Delivery 3.0 Support	no
Independent Hi-Speed Enable and Disable	no
Independent SuperSpeed Enable and Disable	no
Individual Enable and Disable	yes
Individual port voltage measurement, Vbus	yes
Individual port current measurement, Vbus	yes
Individual CC voltage measurement, Vconn	no
Individual CC current measurement, Vconn	no
Link speed detection	no
Programmable port current limits	no
RGB Indicator LEDs	yes
Individual Colour Indicator LEDs	no

Table 7-2

7.2. TS3-C10 Specifications

TS3-C10 Properties					
Colour	Nom	Black	Number of USB Upstream Ports	Nom	-
Control Port Connector Type	Nom	-	Number of USB Upstream Ports	Nom	-
Dimensions Depth (mm)	Nom	136	Number of USB2 Type-A Downstream Ports	Nom	-
Dimensions Height (mm)	Nom	34	Number of USB2 Type-A Expansion Ports	Nom	-
Dimensions Width (mm)	Nom	193	Number of USB2 Type-A Upstream Ports	Nom	-
Downstream Connector Type	Nom	Type-C	Number of USB2 Type-B Upstream Ports	Nom	-
Electrostatic Discharge, air (kV)	Max	-	Number of USB2 Type-C Downstream Ports	Nom	-
Electrostatic Discharge, Vesd (kV)	Max	-	Number of USB2 Type-C Expansion Ports	Nom	-
Enclosure Material	Nom	Plastic	Number of USB2 Type-C Upstream Ports	Nom	-
Expansion Connector Type	Nom	Thunderbolt™ 3	Number of USB3 Type-A Downstream Ports	Nom	-
Form Factor	Nom	Desktop	Number of USB3 Type-A Expansion Ports	Nom	-
Fuse Type	Nom	-	Number of USB3 Type-A Upstream Ports	Nom	-
Host Connector Type	Nom	Thunderbolt™ 3	Number of USB3 Type-C Upstream Ports	Nom	-
Manufacturing Origin	Nom	UK	Output Power, Max (W)	Max	150
Mass (kg)	Nom	0.5	Part Number	Nom	200247

TS3-C10 Properties						
Model Number	Nom	TS3-C10	Power Efficiency at maximum load (%)	Min	-	
Number of Thunderbolt 3 Expansion Ports	Nom	1		Nom	-	
Number of Thunderbolt 3 Upstream Ports	Nom	1		Max	-	
Number of USB Control Ports	Nom	-		Power Type	Nom	DC
Number of USB Downstream Ports	Nom	10		Product Name	Nom	ThunderSync3-C10
Number of USB Expansion Ports	Nom	-		Vbus Source Power (W)	Max	150

Table 7-3

TS3-C10 Environmental Properties		
Ambient Operating Temperature (°C)	Min	0
	Max	35
Relative Humidity Range (%)	Min	20
	Max	80
Storage Relative Humidity Range (%)	Min	5
	Max	95
Storage Temperature (°C)	Min	-20
	Max	60
Operating Altitude Max (m)	Max	2000

Table 7-4

Fan Properties		
Airflow (m3/hr)	Min	-
	Nom	12
	Max	-
Acoustic Noise (dB A)	Min	-
	Nom	28
	Max	-
Start Temperature (°C)	Min	-
	Nom	55
	Max	-
Max Airflow Temperature (°C)	Min	-
	Nom	70
	Max	-
Stop Temperature (°C)	Min	-
	Nom	55
	Max	-

Table 7-5

Boxed Properties		
Dimensions, Depth (cm)	Nom	31
Dimensions, Height (cm)	Nom	34
Dimensions, Width (cm)	Nom	31
Mass (kg)	Nom	2.1

Table 7-6

Power LED Properties					
Colour	Nom	RGB	LED Wavelength, Green (nm)	Min	-
Diameter (mm)	Nom	-		Nom	515
LED Wavelength, Red (nm)	Min	-		Max	-
	Nom	630	LED Wavelength, Blue (nm)	Min	-
	Max	-		Nom	460
Luminous Intensity (mcd)	Nom	500		Max	-

Table 7-7

Hub Endpoint Information		
USB Hub Depth*	Max	2
Memory Used (Kb)	Max	88
Total Endpoints Used	Max	11

Table 7-8

* Hub depth may differ for expansion ports, please see the internal architecture for more information

7.3. Power Specifications

TS3-C10 Power Input Properties		
Connector Type	Nom	4-Pin Mini-DIN
Voltage, Vsupply (V)	Min	-
	Nom	24
	Max	-
Voltage Measurement Rate (Hz)	Nom	-
Voltage Measurement Accuracy, Vsupply (%FSR)	Nom	-
Power, Psupply (W)	Min	-
	Max	-
Power, no devices attached (W)	Min	-
	Nom	-
	Max	-

Table 7-9

AC Power Input Properties		
Operating Current @ 115VAC (A)	Min	4
	Max	4
Operating Current @ 230VAC (A)	Min	2
	Max	2
Operating Voltage, Vsupply (VAC)	Min	100
	Max	250
Under Voltage Threshold (VAC)	Min	-
	Nom	-
	Max	-
Over Voltage Threshold (VAC)	Min	-
	Nom	-
	Max	-
Voltage Measurement Resolution, Vsupply (mVAC)	Nom	-
Frequency Range (Hz)	Min	-
	Max	-

Table 7-10

TS3-C10 DC Power Input Properties		
Under Voltage (V)	Min	-
	Nom	-
	Max	-
Current, Isupply (A)	Min	-
	Max	8
Over Voltage (V)	Min	-
	Nom	-
	Max	-
Voltage Measurement Resolution, Vsupply (mV)	Nom	-

Table 7-11

PSU Properties		
Dimensions, Depth (mm)	Nom	85
Dimensions, Height (mm)	Nom	46
Dimensions, Width (mm)	Nom	210
Input Connector Type	Nom	C14
Input Power Type	Nom	AC
Output Connector Type	Nom	4-Pin Mini-DIN
Output Power Max (W)	Max	221
Output Power Type	Nom	DC
Part Number	Nom	-
Power Efficiency, at maximum load (%)	Min	-
	Nom	-
	Max	-

Table 7-12

Power connection pin layout		
	Pin	Function
	1	+Vo
	2	+Vo
	3	-Vo
	4	-Vo

Table 7-13

*-V is connected to AC input ground.

7.4. Port Specifications

USB Downstream Port Properties					
Short Circuit Detection Time (ms)	Max	-	Vbus Output Current, CDP Mode (A)	Nom	3
Short Circuit Response Time (μ s)	Max	-	Vbus Output Current, DCP Mode (A)	Nom	3
USB D Logic Low Voltage (V)	Min	0	Vbus Output Current, SDP Mode (A)	Nom	0.9
	Max	0.3	Vbus Output Power (W)	Max	15
USB D Logic High Voltage (V)	Min	2.8	Vbus Output Voltage (V)	Min	4.8
	Max	3.6		Nom	5
USB Hi-Speed Data Rate (Mbps)	Nom	480		Max	5.2
USB SuperSpeed Data Rate (Gbps)	Nom	5	Vbus Source Power (W)	Max	-
Vbus Current Measurement Accuracy (%FSR)	Min	-	Vbus Voltage Measurement Accuracy (%FSR)	Min	-
	Max	-		Max	-
Vbus Current Measurement Range (A)	Min	-	Vbus Voltage Measurement Range (V)	Min	-
	Max	-		Max	-
Vbus Current Measurement Rate (Hz)	Nom	-	Vbus Voltage Measurement Rate (Hz)	Nom	10
Vbus Current Measurement Resolution (mA)	Nom	-	Vbus Voltage Measurement Resolution (mV)	Nom	-
Vbus Current Setpoint Resolution (mA)	Nom	-	Vbus Voltage Ripple (mV)	Max	-
Vbus Output Current (A)	No	3	Vbus Voltage Setpoint Resolution (mV)	Nom	-

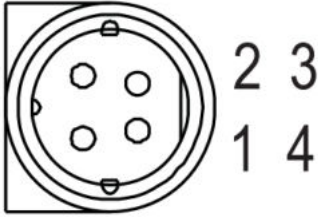
Table 7-14

Table 7-15

Upstream Port Properties		
Vbus Input Current (mA)	Min	-
	Nom	-
	Max	-
Vbus Input Power (W)	Min	-
	Nom	-
	Max	-
Vbus Input Voltage (V)	Min	-
	Nom	-
	Max	-
Connection speed (Gbps)	Nom	40

Indicator LED Properties		
LED Wavelength, Red (nm)	Min	-
	Nom	630
	Max	-
LED Wavelength, Green (nm)	Min	-
	Nom	515
	Max	-
LED Wavelength, Blue (nm)	Min	-
	Nom	460
	Max	-
Diameter (mm)	Nom	3
Luminous Intensity (mcd)	Nom	500

Table 7-16

USB Type-C Port Properties		
Vconn, Output Current (A)	Max	-
Vconn, Output Voltage (V)	Min	-
	Nom	-
	Max	-
Vconn, Output Voltage Ripple (mV)	Max	-

Table 7-17

USB3 Downstream Port Properties		
USB SuperSpeed Data Rate (Gbps)	Max	5
USB SS TX Logic Low Voltage (V)	Min	-
	Max	-
USB SS TX/RX Logic High Voltage (V)	Min	-
	Max	-

Table 7-18

Ports Lifetime

Standard USB connections have a minimum rated lifetime of 1,500 cycles of insertion and removal. USB-C receptacles have a minimum rated lifetime of 10,000 cycles of insertion and removal. This is an industry-standard.

One thing you can do to prolong the lifetime of the ports on your ThunderSync3-C10 is to use "sacrificial cables" in between the hub and your charging cables so when you repeatedly connect/disconnect you are only going to wear the cables rather than the hub.

7.5. Drawings

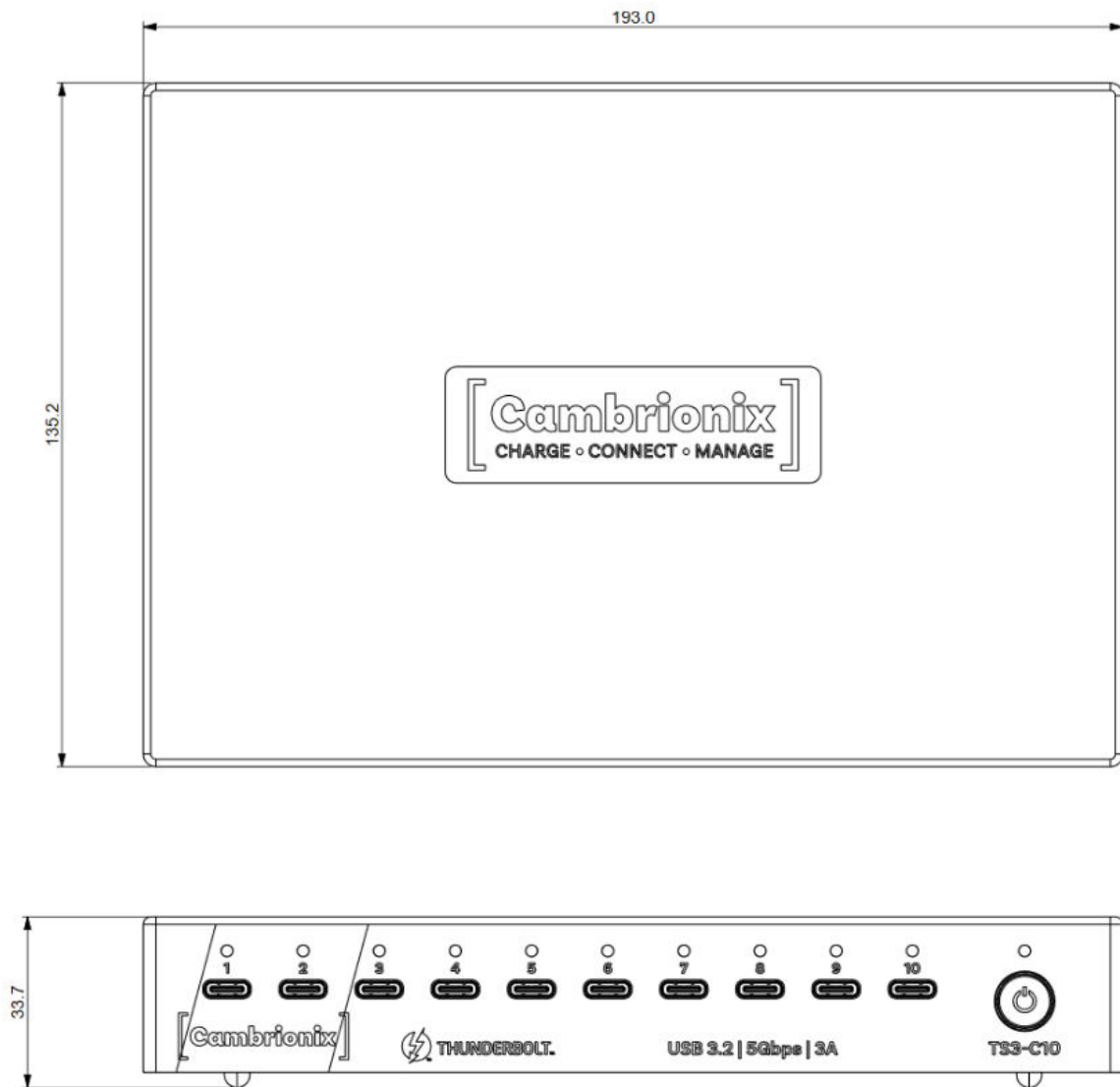

Figure 7.1

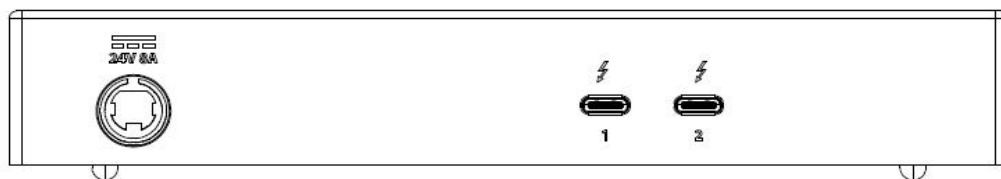

Figure 7.2

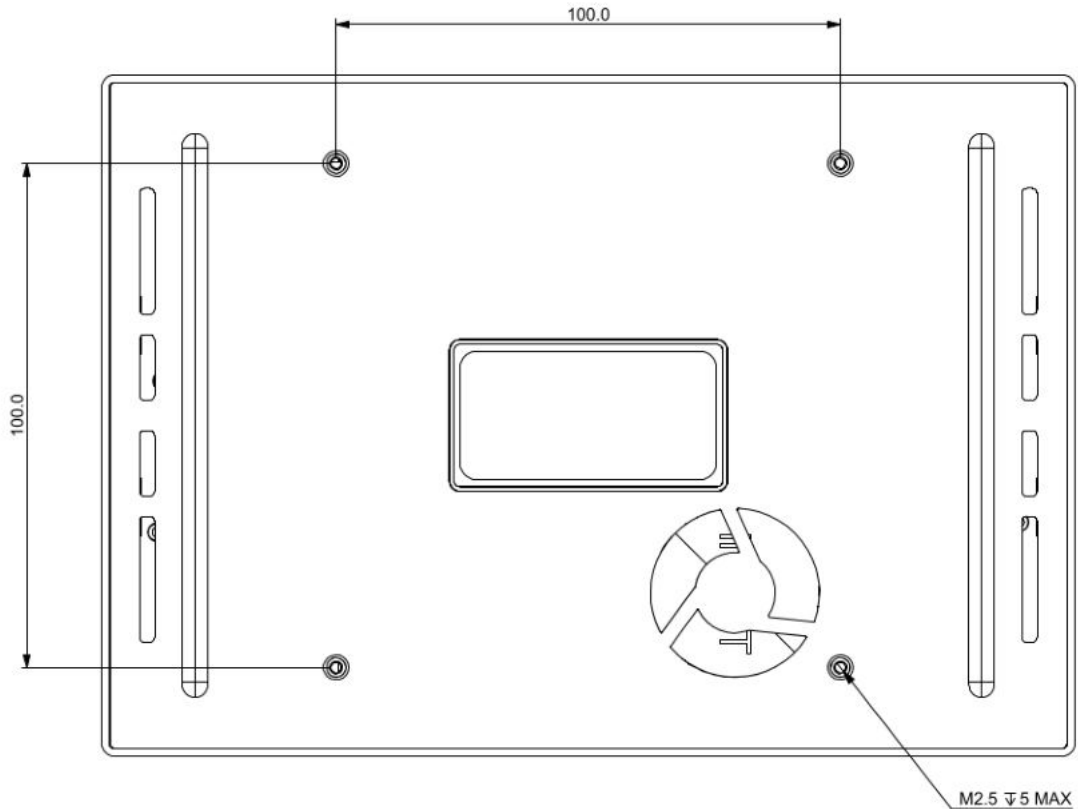

Figure 7.3

7.6. Product Label

The following label can be found on the ThunderSync3-C10. This is where you can find the information such as the part number and Logos for Compliance and Standards applicable to the TS3-C10

For more information please see the [Compliance and Standards](#) section.

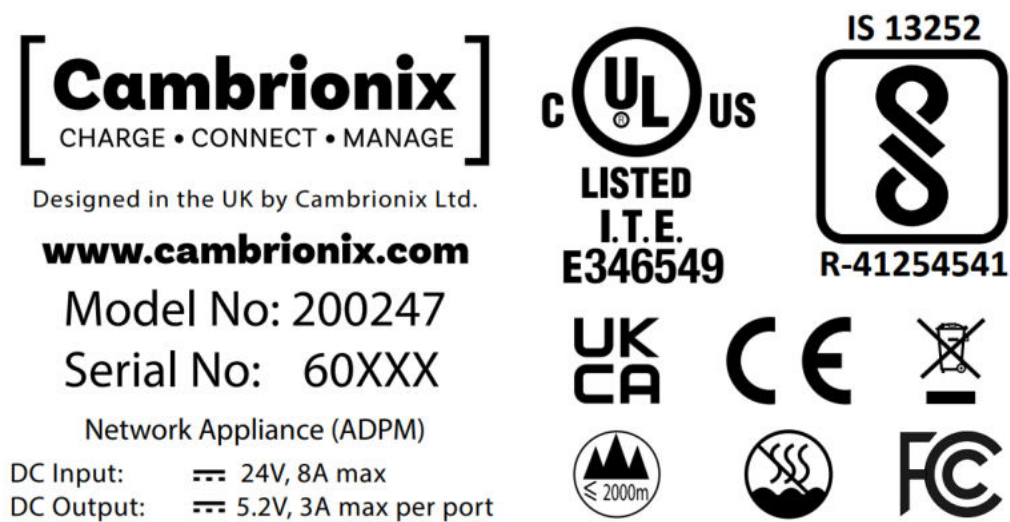

Figure 7.4

7.7. Hub Architecture

Below is a diagram of the internal architecture for the ThunderSync3-C10.

	Fig	Description
	1	This is the external physical port number
	2	This is present if this component is connected to an internal hub, if it is present the number represents the port number on the internal hub

Table 7-19

Background colour	Description
	An External physical port you can connect a USB device to
	The Host port that you will connect the host computer to
	An Internal hub which can then connect to external ports or other internal components
	Any other components which includes expansion ports and internal chips

Table 7-20

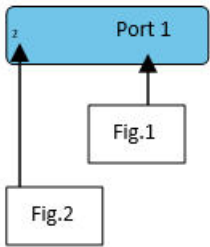
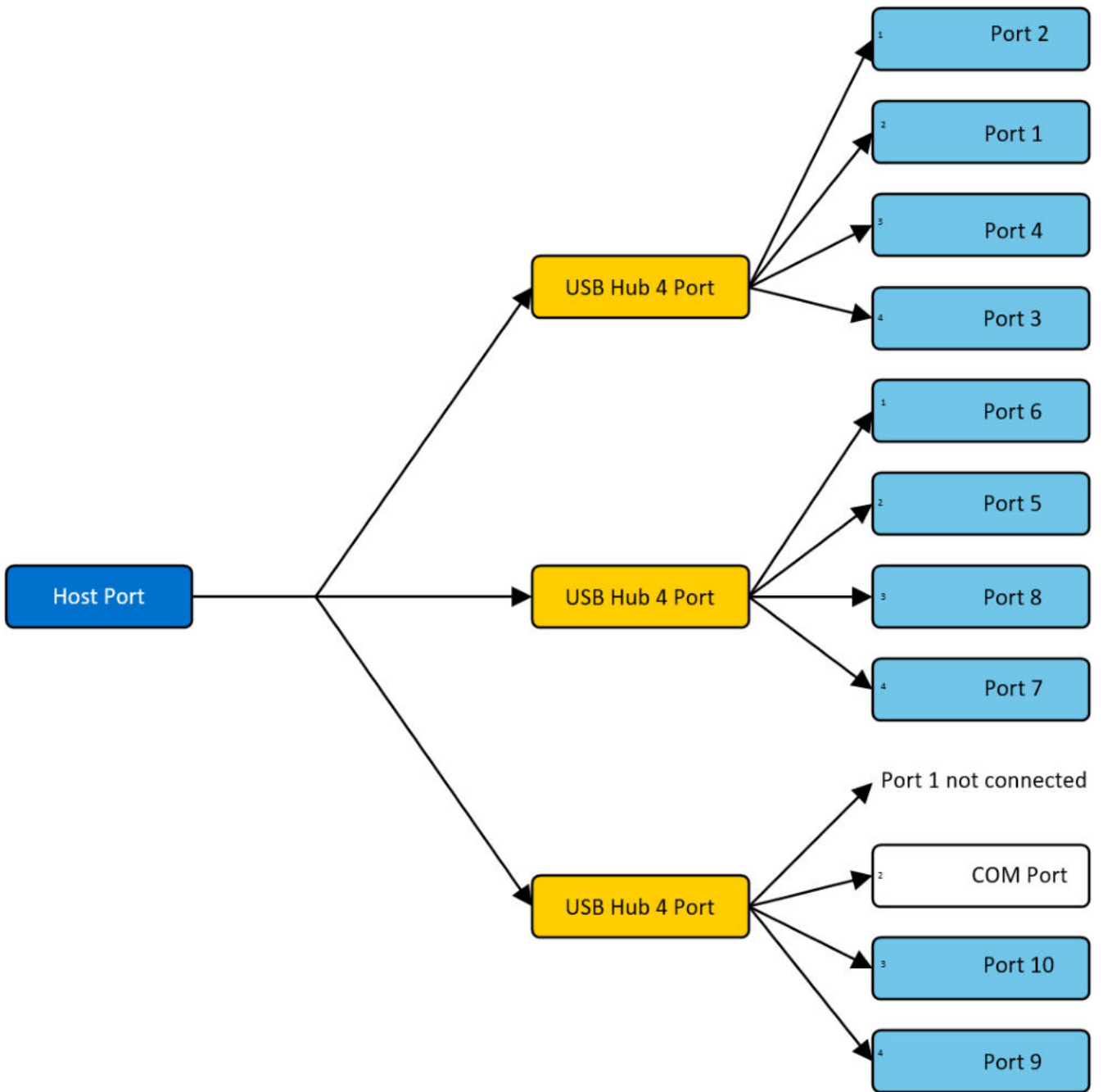

Figure 7.5

8. Troubleshooting

If you experience any issues with your ThunderSync3-C10; please try the following troubleshooting steps, if the issue is not addressed in this section, please get in touch with your local vendor or Cambrionix. To contact Cambrionix Support please see [Help and Support](#).

8.1. Common troubleshooting tips

Some tips and information to check first.

- If you directly connect the same device to the port the hub is in, does it appear to the OS.
- If you plug a device (phone, USB stick) into the hub, does it appear to the OS (device manager/ system info etc.).
- Are you using a Thunderbolt™ host cable? (USB Type-C does not equal Thunderbolt™)
- Is the Thunderbolt™ cable connected to a Thunderbolt™ port?
- Try switching the cables with ones that are working/ use cable from a hub that is working.

8.2. Logging through Cambrionix Connect

If you are experiencing a bug or an issue, we may ask you to obtain some logs of the behaviour, to see in more detail what is happening. To get logs of the behaviour use the following steps to get a zip file of the logs.

1. Open Cambrionix Connect (if this is not already downloaded, then go onto our website and download both the API and Cambrionix Connect) www.cambrionix.com/software
2. Once in Cambrionix Connect, on the left-hand side of the screen, select the settings section.
3. Once in the settings section, select the API tab.
4. In the API section click the "cog" button on the right hand side of the local API
5. Click the "select all" tick box and then the save button.
6. After this is enabled, use the hub in a way that causes the issue you are seeing.
7. Wait for the issue to occur, i.e. device disconnects.
8. Make a note of the time and date that the issue occurs then go back to the API page in Cambrionix Connect, and press the zip logs.
9. Once you have the logs un-tick the "select all" box and save your settings.
10. Send the logs to us for us to take a look at.

The API keeps a maximum of 20 logs at 256Mb each, so the latest one is usually smaller. If a crash occurs, you would see a smaller log file and the next instance of API shuffles the existing ones

Default locations

Log messages generated by the CambrionixApiService go to syslog.

Using Windows the logs will default to the below location

```
C:\ProgramData\Cambrionix
```

Using macOS the logs will default to the below location

Library>Logs>Cambrionix

Using Linux the logs will default to the below location

```
/var/log/cambrionix
```

8.3. Hardware Failure

If the Hardware fails, the LEDs can flash in a pattern to determine the type of failure. If no LEDs are on the downstream ports, this will be the red power LED flashing in a pattern.

The unit will blink(B) four times, followed by eight long(L) or short(S) flashes, which then repeat. The flashes are a number in binary which match a number in our error code list.

i.e if the LED flashes the following - BBBB SLSSSLSS, the binary number is 01000100.

8.4. Device connection

If you are seeing any device connection issues please read through the following trouble shooting steps to see if this resolves the observed behaviour.

Device issues when updating

We have found that during updates on some devices the connection can be dropped or lost on the device, this is due to devices going in and out of the bootloader and requiring different power levels. In most instances disabling CDP has resolved this issue for our customers.

You can disable CDP through Internal hub settings either by going through the advanced settings and turning "Sync charge" off or through the API and disabling it via code. For example, the instructions would be below using the command line.

```
settings_unlock  
settings_set sync_chrg 0000000000000000
```

Unstable device connection

Some devices can have unstable connections with your host system through the ThunderSync3-C10. We have only observed this behaviour in a very few amount of devices, disabling CDP and setting the ports to always be on has resolved all issues and the connections are stable.

You can disable CDP through Internal hub settings either by going through the advanced settings and turning "Sync charge" off or through the API and disabling it via code. For example, using the command line, the instructions would be as below.

```
settings_unlock  
settings_set sync_chrg 0000000000000000
```

You can set the ports to always be on through Internal hub settings through the advanced settings and turning "Ports On" settings to always on for each port. When you set the port to always be on you will need to set a default profile on each port for when the port(s). There is a description for each profile within Cambrionix connect.

Battery information for Android

If you are observing an issue displaying battery information on Android devices ensure firstly you have ADB tool installed and open then try these things in order.

1. Check that developer options are enabled on the android device, and then that USB debugging is also enabled.
2. If you have done this step and it still does not work, go to Developer Options and click 'Revoke USB debugging authorisations'. Unplug the cable and reconnect.
3. If this still doesn't work, turn off the developer options at the top, re-enable it, and re-enable 'USB Debugging'.
4. You can get detailed info directly from ADB at each step to diagnose things:

```
adb.exe shell dumpsys battery # Use -s SERIAL_NUMBER as first options  
if you have more than 1 Android attached
```

Unknown devices

Sometimes, within Cambrionix Connect and device manager, the connected device may show up as an unknown device.

This can be due to the host system needing to be trusted on the device. This can be done on the device itself on the initial connection.

This could also be due to an insufficient number of endpoints available on the USB controller in the host system. This limitation within the USB controller can only be resolved if you connect fewer USB devices to the controller in question.

For Apple devices there is a setting called "USB accessories" which can be activated, Once activated it will reduce the amount of times a device will need to be unlocked/ trusted. More information can be found at the link <https://support.apple.com/en-gb/HT208857>.

Cannot connect any more devices

Sometimes, you may reach the endpoint limit of your USB controller and this may stop you from being able to attach any more devices to your host system.

You can create more space is to change connections from USB3 to USB2. You can change the connection by disabling USB3 in the BIOS on startup.

A much simpler way is to use USB2 cables instead of USB3 cables, limiting the connection to USB2.

8.5. Hub connection issues

If you there are issues with the hub and connecting to your host system, please see below troubleshooting solutions.

Hub not connecting to host

If you see that the ThunderSync3-C10 is not connecting to the host system, one of the issues may be caused by the USB drivers on your host system not being up to date. It is good practice to ensure you have the latest drivers and updates installed on your host system, which is usually handled by the OS, but sometimes may require an update directly from the USB host controllers manufacturer, which will be found on their website.

USB drivers required are FTDI drivers, which can be found on the site <https://ftdichip.com/drivers/>.

Cannot access the COM port

You may get an error message stating "COM (and then a number) could not be opened (Access is denied)".

This is because an application has control over the COM port that the hub is connected to, and no subsequent application can access the hub. To resolve this, you will need to close any other applications that are using the COM port before trying to use the COM port.

8.6. Using with a headless system

If you are using a headless system with no GUI, then and you require to enable logging for support issues, you can use the following command to create the logging cfg file manually:

```
echo*=DEBUG>/etc/opt/cambrionix/cambrionix.log.cfg
```

Then after re-producing the problem, you can zip the logs from the folder

```
/var/log/cambrionix
```

You may delete the file below when you are finished with it.

```
/etc/opt/cambrionix/cambrionix.log.cfg
```

8.7. Software troubleshooting

Some users have noted that the API can cause a high level of CPU usage. This can sometimes be linked to the API recorder service. If you are finding this and you are not using it then we would

recommend to uninstall it from your system entirely. Information on how to uninstall programs can be found in the [Removing Software](#) section.

9. Returns and Damaged Products

If you wish to return or fix a damaged product first look at the terms on our website www.cambrionix.com/terms-conditions

Before a product is returned please contact support using the methods detailed in the [Help and Support](#) section.

9.1. What if my order arrives with an issue?

- If you have received your order in a damaged box and/or the product has physical damage please contact Cambrionix Customer Support or your distribution partner. Please provide photos of the damaged box and/or product when contacting Customer support.
- If an item in your order does not have physical damage but is not functioning properly or will not power on, please contact Customer Support or your distribution partner and provide as much information as possible and including any steps followed to troubleshoot internally.
- Please include photos of the damaged box and product when contacting Customer Support.







Note: If you have received your order in a damaged box and the damage was indicated to the courier, please provide us with a copy of the delivery note detailing this.

9.2. What happens after I have requested a Return?

- If you have not purchased the Product(s) direct from Cambrionix please contact the vendor the item was originally purchased from for their returns process.
- Once you have notified Cambrionix of your return, Cambrionix will arrange for the collection of the product(s), or provide instructions and details for you to return the product direct.
- When returning your product(s), please only send back the items that were advised through the support process.
- Return your product(s) in the original packaging where you can. Where original packaging is not available, use suitable packing methods, which will ensure that the product cannot be subject to impact damage. i.e. double-walled cardboard box with 50mm of soft material.
- Product(s) not returned in their original condition may result in additional costs, please refer to the warranty and terms section on our [website](#).
- Where Cambrionix arranges collection, return shipping will be free, unless Cambrionix notified you otherwise.
- When contacting us about returning a product please provide the following information.
 - Collection Address
 - Weights and Dimensions WxDxH (m) of shipment
 - Preferred collection date and time.
 - Product serial number(s) (this can be found on a label on the rear or underside of the unit)
 - Purchase order number(s)

10. Compliance and Standards

The ThunderSync3-C10 has secured official certification in strict compliance with established industry standards that are widely recognized. Below, you will find information relating to these certifications:

FCC Declaration of Conformity	
Declaration of RoHS Compliance	
CE Declaration of Conformity	
Bis Certification	
UL Certification	
Waste Electrical and Electronic Equipment (WEEE)	

10.1. EU RoHS Compliance

	<p>We declare that the ThunderSync3-C10 comply with The European RoHS Directive 2011/65/EU (Restriction of the Use of Certain Hazardous Substances in Electrical and Electronic Equipment), which restricts substances in electrical and electronic equipment:</p>
---	--

With Exemptions

☑	6c	Copper alloy containing up to 4% lead by weight
☑	7a	Lead in high melting temperature type solders (lead-based alloys containing 85 % by weight or more lead).
☑	7c-1	Electrical and electronic components containing lead in a glass or ceramic other than dielectric ceramic in capacitors (piezoelectronic devices) or in a glass or ceramic matrix compound.

You can access and download the complete EU RoHS Declaration of Conformity by following the provided link:

<https://downloads.cambrionix.com/documentation/en/TS3-C10-EU-RoHS-DOC.pdf>

10.2. Bis Certification

For export to India, manufacturers need BIS certification (ISI) under Foreign Manufacturers Certification Scheme (FMCS), or BIS registration (CRS) for certain products. The BIS Certification is obligatory for these products, so that they can be introduced and sold on the Indian market. BIS Certification India or BIS Registration issued by the Bureau of Indian Standards (BIS) ensure the quality, safety and reliability of products in accordance with Indian Standards (IS).

<p>IS 13252</p>  <p>R-41254541</p>	License Number	R-41254541
	Model	ThunderSync3-C10 / TS3-C10
	IS NO	IS 13252(PART 1):2010/ IEC 60950-1 : 2005
	Brand	Cambrionix Ltd.

10.3. UL Certification

	<p>This is to certify that representative samples of the product as specified on this certificate were tested according to the current UL requirements</p>
---	--

Certificate Number	UL-US-2155788-0
Issued to	Cambrionix Ltd.
Standard(s) for Safety	UL 62368-1, 2nd Ed., Issue Date: 2014-12-01

Certificate Number	UL-CA-2146930-0
Issued to	Cambrionix Ltd.
Standard(s) for Safety	CSA C22.2 NO. 62368-1-14, 2nd Ed., Issue Date: 2014-12- 01

See the UL Online Certifications Directory at www.ul.com/database for additional information

10.4. Waste Electrical and Electronic Equipment (WEEE)

Disposal of Old Electrical & Electrical Equipment (Applicable in the European Union and other European countries with separate collection systems)

	<p>This product is subject to Directive 2012/19/EU of the European Parliament and the Council of the European Union on the waste electrical and electronic equipment (WEEE), and in jurisdictions adopting that Directive, is marked as being put on the market after August 12, 2005, and should not be disposed of as unsorted municipal waste. Please utilize your local WEEE collection facilities in the disposition of this product and otherwise observe all applicable requirements.</p>
---	--

Cambrionix PRN (Producer Registration Number) For the UK is "WEE/BH191TT".

Use of Trademarks, Registered Trademarks, and other Protected Names and Symbols

This manual may make reference to trademarks, registered trademarks, and other protected names and or symbols of third-party companies not related in any way to Cambrionix. Where they occur these references are for illustrative purposes only and do not represent an endorsement of a product or service by Cambrionix, or an endorsement of the product(s) to which this manual applies by the third-party company in question.

Cambrionix hereby acknowledges that all trademarks, registered trademarks, service marks, and other protected names and /or symbols contained in this manual and related documents are the property of their respective holders

"Mac® and macOS® are trademarks of Apple Inc., registered in the U.S. and other countries and regions."

"Intel® and the Intel logo are trademarks of Intel Corporation or its subsidiaries."

"Thunderbolt™ and the Thunderbolt logo are trademarks of Intel Corporation or its subsidiaries."

"Android™ is a trademark of Google LLC"

"Chromebook™ is a trademark of Google LLC."

"iOS™ is a trademark or registered trademark of Apple Inc, in the US and other countries and is used under license."

"Linux® is the registered trademark of Linus Torvalds in the U.S. and other countries"

"Microsoft™ and Microsoft Windows™ are trademarks of the Microsoft group of companies."

"Cambrionix® and the logo are trademarks of Cambrionix Limited."

Cambrionix Patents

Title	Link	Application Number	Grant Number
Syncing and Charging Port	GB2489429	1105081.2	2489429
CAMBRIONIX	UK00002646615	2646615	00002646615
CAMBRIONIX VERY INTELLIGENT...	UK00002646617	2646617	00002646617
MOD IT DS	GB2591233	6089600	6089600
MOD IT	eSearch	007918669	007918669
MOD IT	90079186690001	007918669-0001	90079186690001
MOD IT	90079186690002	007918669-0002	90079186690002
MOD IT	90079186690003	007918669-0003	90079186690003
MOD IT	90079186690004	007918669-0004	90079186690004
MOD IT	90079186690005	007918669-0005	90079186690005
MOD IT	90079186690006	007918669-0006	90079186690006
MOD IT		195761	195761
MOD IT DS		30202007995X	30202007995X
MOD IT MM		30202007994Y	30202007994Y
MOD IT STACK		30202007993P	30202007993P
MOD IT DS	6077253	6077253	6077253
MOD IT DS	3a2f8b88e935	202012311	202012311
MOD IT DS		195759	195759
MOD IT DS		329440-001	
MOD IT DS		29/735,477	D936,001
MOD IT	6077254	6077254	6077254
MOD IT MM	6077255	6077255	6077255
MOD IT MM	2a6ebe915fe9	202012310	202012310
MOD IT MM		195758	
MOD IT MM		329441-001	

Title	Link	Application Number	Grant Number
MOD IT MM		29/735,479	
MOD IT	6077256	6077256	6077256
MOD IT STACK	6077257	6077257	6077257
MOD IT STACK	081a4b9c69eb	202012312	202012312
MOD IT STACK		29/735,475	D936,000
MOD IT DS LUGS	6089601	6089601	6089601
MOD IT MM	6089602	6089602	6089602
MOD IT DS LUGS	6089603	6089603	6089603
MOD IT STACK	6089604	6089604	6089604
MOD IT	6089605	6089605	6089605

Terms and Conditions

The use of Cambrionix hubs is subject to the Cambrionix Terms and Conditions, the document can be downloaded and viewed using the following link.

<https://downloads.cambrionix.com/documentation/en/Cambrionix-Terms-and-Conditions.pdf>

Cambrionix Limited
The Maurice Wilkes Building
Cowley Road
Cambridge CB4 0DS
United Kingdom

+44 (0) 1223 755520
www.cambrionix.com

Cambrionix Ltd is a company registered in England and Wales
with the company number 06210854