

600A AC Clamp Meter + NCV Model MA610

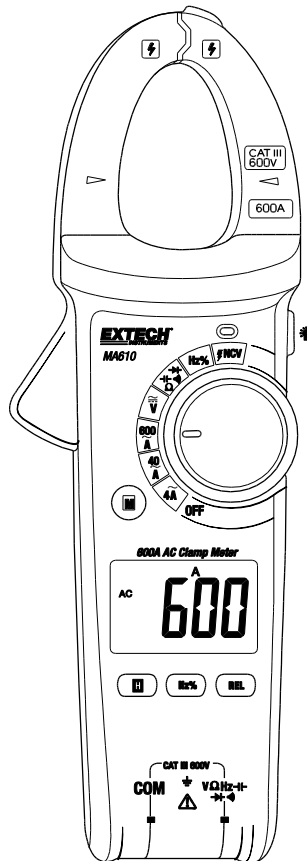

Introduction

Thank you for selecting the Extech MA610 Clamp Meter. This meter measures AC Current, AC/DC Voltage, Resistance, Capacitance, Frequency, Diode Test, Duty Cycle, Continuity and Non-Contact Voltage detection. This device is shipped fully tested and calibrated and, with proper use, will provide years of reliable service. Please visit our website (www.extech.com) to check for the latest version and translations of this User Manual, Product Updates, Product Registration, and Customer Support.

Features

- Large backlit LED display
- 30mm (1.2") jaw size fits conductors up to 500MCM
- Relative and Zero mode functionality
- Auto Power OFF (APO)
- Non-Contact Voltage Detector
- Visual and audible continuity measurement alert
- Low battery indicator
- CAT III 600V

Safety

To ensure the safe operation and service of the meter, follow these instructions closely. Failure to observe warnings can result in severe injury.



WARNINGS

WARNINGS identify hazardous conditions and actions that could cause BODILY HARM or DEATH.

- When handling test leads or probes, keep hands and fingers behind the finger guards at all times.
- Remove test leads from the meter before opening the battery compartment or meter housing.
- Use the meter only as specified in this User Manual or accompanying Quick Start to avoid compromising the protections provided by the meter.
- Be sure to use the proper terminals, switch positions, and ranges when taking measurements.
- Verify the meter's operation by measuring a known voltage. Have the meter serviced if the meter responds unusually or if there are questions regarding the meter's functional integrity.
- Do not apply more than the rated voltage, as marked on the meter, between terminals or between any terminal and earth ground.
- Use caution working with voltages above 30 VAC RMS, 42 VAC peak, or 60 VDC. These voltages pose a shock hazard.
- To avoid misleading readings that could lead to electric shock and injury, replace the batteries as soon as the low battery indicator is displayed.
- Disconnect power to the circuit under test and discharge all high-voltage capacitors before testing resistance, continuity, diodes, or capacitance.











- Do not use the meter in the presence of explosive gas or vapor.
- To reduce risk of fire or electric shock, do not use the meter if it is wet and do not expose the meter to moisture.
- Individual protective equipment should be used if HAZARDOUS LIVE parts in the installation where measurements are to be carried out could be accessible.

CAUTIONS

CAUTIONS identify conditions and actions that could cause DAMAGE to the meter or equipment under test. Do not expose the meter to extremes in temperature or high humidity.

- Disconnect the test leads from the test points before changing the position of the function (rotary) switch.
- Do not expose the meter to extremes in temperature or to high humidity.
- Never set the meter to the resistance, diode, capacitance, or amp functions when measuring the voltage of a power supply circuit; this could result in meter damage and damage to the equipment under test.

Safety Symbols

	This symbol, adjacent to another symbol, indicates the user must refer to the manual for further information.
	Risk of electrical shock
	Equipment protected by double or reinforced insulation
	Diode symbol
	Capacitance
	Battery symbol
	Conforms to EU directives
	Complies with USA and Canada requirements
	AC measurement
	DC measurement
	Earth ground

PER IEC1010 OVERVOLTAGE INSTALLATION CATEGORY

OVERVOLTAGE CATEGORY I

Equipment of OVERVOLTAGE CATEGORY I is equipment for connection to circuits in which measures are taken to limit the transient over-voltages to an appropriate low level.

Note – Examples include protected electronic circuits.

OVERVOLTAGE CATEGORY II

Equipment of OVERVOLTAGE CATEGORY II is energy-consuming equipment to be supplied from the fixed installation.

Note – Examples include household, office, and laboratory appliances.

OVERVOLTAGE CATEGORY III

Equipment of OVERVOLTAGE CATEGORY III is equipment in fixed installations.

Note – Examples include switches in the fixed installation and some equipment for industrial use with permanent connection to the fixed installation.

OVERVOLTAGE CATEGORY IV

Equipment of OVERVOLTAGE CATEGORY IV is for use at the origin of the installation.

Note – Examples include electricity meters and primary over-current protection equipment

Description

Meter Description

1. Transformer current jaws
2. Jaw opening trigger
3. M (Mode) button
4. Backlit LCD
5. Control buttons (see descriptions below)
6. COM negative input terminal
7. Positive input terminal
8. Function selector
9. NCV alert lamp
10. Backlight button
11. NCV sensor

Note: Battery compartment is located on back of meter

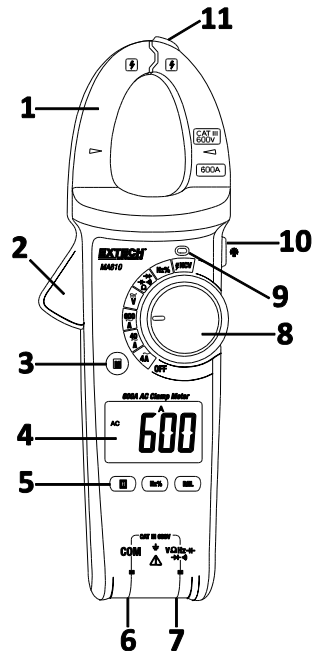











Fig. 1 – Meter Description

Display Description

	Relative mode icon	Hz kHz MHz	Units of Frequency
AC	Alternating Current	mV V	Units of Voltage
DC	Direct Current	nF μF mF	Units of Capacitance
	Negative readings	NCV	Non-contact AC Voltage Detect
	Diode mode	Auto	Automatic range mode
	Continuity mode		Low Battery icon
H	Display Hold	%	Duty Cycle
Ω kΩ MΩ	Units of resistance	OL	Measurement overload

Control Buttons

	Mode button: Short press to step through the mode options for the selected measurement function
	HOLD button: Short press to freeze/unfreeze reading
	Backlight button: Short press to turn backlight ON or OFF. Note that the backlight button is on the upper right side of the meter.
	For AC/DC voltage, AC current and Resistance modes: Short press to store the displayed reading as a reference value. Subsequent measurements will be displayed as 'measurement minus reference value'. Short press to exit. For Capacitance mode, short press to zero the display; the LCD will show the delta symbol. Short press to exit this mode.
	Short press to step through frequency (Hz) and duty cycle (%) measurements for the Voltage and Hz switch positions.

Operation



CAUTION: Read and understand all of the Safety statements listed in the safety section of this manual prior to use.

Powering the Meter

1. Move the function switch to any position to power the meter. Check the batteries if the unit fails to power ON.
2. Move the function switch to the OFF position to remove power to the meter.
3. The meter has an Auto Power OFF feature (APO) where the meter switches OFF after 30 minutes of inactivity. Press any button to recover from an APO condition.

Low battery indication

When the  icon appears in the display, the battery should be replaced. Refer to the battery replacement procedure in the maintenance section.

AC Current Measurements



WARNING: Do not handle the meter above the finger/hand guard barrier.



CAUTION: Observe CAT III 600V with respect to Earth Ground for the Jaw.

1. Rotate the function switch to the desired AC Current position (4A, 40A, or 600A). Start with the highest range setting (600A) and step down to lower ranges as needed, especially for signals that are of an unknown range.
2. The **A** and the **AC** symbols will appear on the display indicating AC Amperes (Amps).
3. Press the jaw trigger to open the clamp jaw.
4. Position the clamp around only one conductor. See Fig. 2 for correct and incorrect clamp technique.
5. Read the current in the display. The display will indicate the proper decimal point and value.

NOTES:

To ensure maximum accuracy, place the conductor at the center of the clamp head, otherwise additional error ($\pm 1.0\%$) may apply.

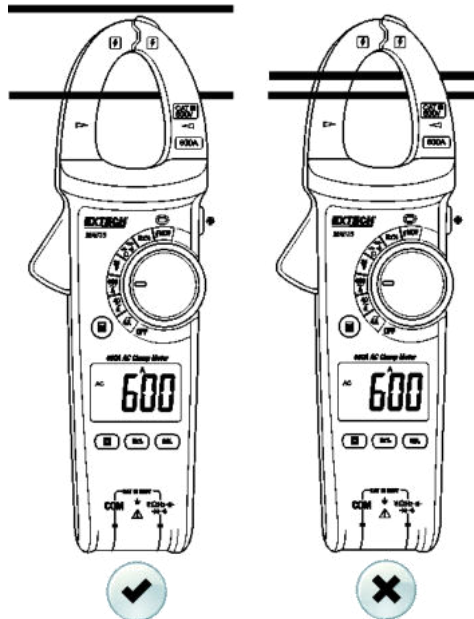



Fig. 2 – Correct and Incorrect ACA Clamping

AC and DC Voltage Measurements



WARNING: Do not apply > 600VAC/DC between the meter terminals and ground.

CAUTION: When connecting the test leads to the circuit or device under test, connect the black lead before the red lead; when removing the test leads, remove the red lead before the black lead.

1. Set the function select switch to the Voltage position .
2. Use the **M** (Mode) button to select **AC** or **DC** Voltage.
3. Insert the black test lead banana plug into the negative (COM) jack and the red test lead banana plug into the red (V) jack. See Fig. 3.
4. Touch the test probe tips to the circuit or part under test.
5. Read the voltage in the LCD. The display will indicate the proper decimal point and value.
6. Relative (REL) mode can be used to set a reference reading from which subsequent readings will be offset ($reference\ reading - actual\ reading = displayed\ reading$). Short press the **REL** button to store the displayed reading as a reference to which subsequent measurements will be compared. Short press the **REL** button to exit the relative mode.
7. The meter can display the frequency (Hz) or duty cycle (%) of the measured voltage. Short press the **Hz %** button to step through frequency and duty cycle readings.
8. Short press the **H** button to freeze/unfreeze the displayed reading.

NOTES: The LCD displays **OL** when the input exceeds 1000V.

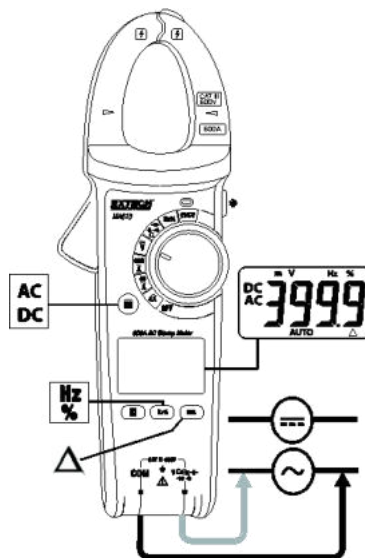

Fig. 3 – AC/DC Voltage Measurements

Resistance Measurements



WARNING: Please remove power to the circuit under test and discharge all capacitors before taking resistance or continuity measurements. The meter will display **OL** if the circuit under test is an open circuit or if the measurement exceeds the maximum range of the meter. Do not input a voltage >30V AC or DC.

1. Turn the function switch to the Resistance Ω position.
2. Use the **M** (mode) button to select the ohm Ω display symbol.
3. Insert the black test lead banana plug into the negative (COM) jack. Insert the red test lead banana plug into the red (Ω) jack. See Fig. 4.
4. Touch the test probe tips across the circuit or part under test. It is best to disconnect one side of the part under test so that the rest of the circuit will not interfere with the resistance reading.
5. Read the resistance in the display. The display will indicate the proper decimal point and value.
6. Relative (REL) mode can be used to set a reference reading from which subsequent readings will be offset (*reference reading – actual reading = displayed reading*). Short press the **REL** button to store the displayed reading. The Relative icon (triangle) appears when the Relative mode is active. Short press the **REL** button to exit the relative mode.

NOTE: When measuring resistance >1M Ω the meter may require several seconds to obtain a stable reading.

Fig. 4 – Resistance Measurements

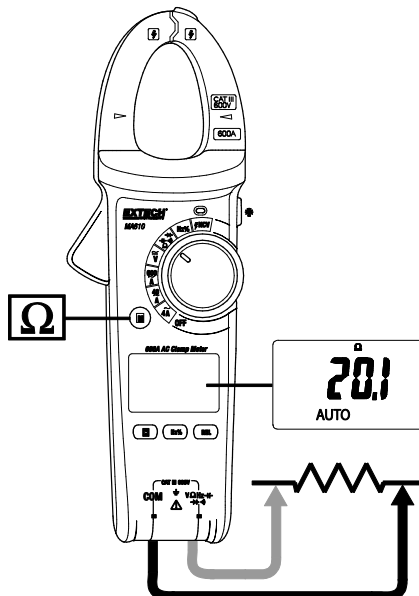

Continuity Measurements



WARNING: Please remove power to the circuit under test and discharge all capacitors before taking resistance or continuity measurements. The meter will display **OL** if the circuit under test is an open circuit or if the measurement exceeds the maximum range of the meter. Do not input a voltage $>30\text{V}$ AC or DC.



1. Turn the function switch to the Continuity  position.
2. Use the **M** (mode) button to select the continuity display  icon.
3. Insert the black test lead banana plug into the negative (COM) jack. Insert the red test lead banana plug into the red (Ω) jack. See Fig. 5.
4. Touch the test probe tips across the circuit or wire.
5. If the resistance is $< 10\Omega$, the meter will beep. If the resistance is $> 70\Omega$, the meter will not beep. If the resistance is between 10 and 70Ω , the meter will stop beeping at an unspecified point.

Fig. 5 – Continuity Measurements



Frequency Measurements

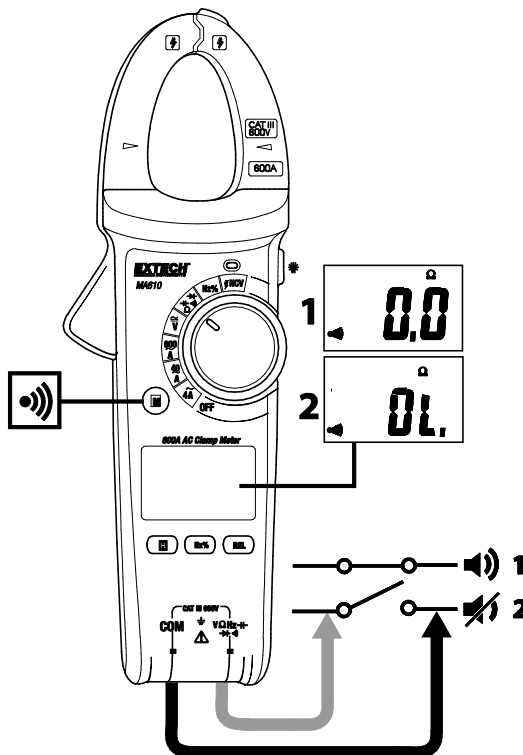

WARNING: Do not input voltages > 30Vrms when measuring frequency.

Turn the function switch to the **Hz** position.

1. Insert the black test lead banana plug into the negative (COM) jack. Insert the red test lead banana plug into the red jack. See Fig. 6.
2. Touch the test probe tips across the circuit or component.
3. Read the Frequency measurement on the meter display.
4. Use the **Hz%** button to view **Duty Cycle %**.

Fig. 6 – Frequency Measurements

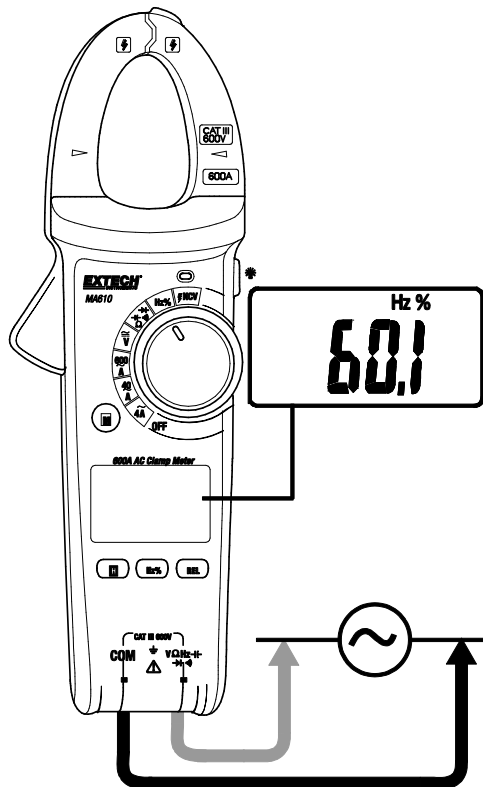

Capacitance Measurements



WARNING: Please remove power to the circuit under test and discharge all capacitors before taking capacitance measurements.

1. Turn the function switch to the $\text{--}\text{||}\text{--}$ position.
2. Use the **M** (mode) button to select the capacitor function if necessary.
3. Insert the black test lead banana plug into the negative (COM) jack. Insert the red test lead banana plug into the red jack. See Fig. 7.
4. Touch the test probe tips across the circuit or component.
5. Read the Capacitance measurement on the meter display. For readings $> 400\mu\text{F}$, several minutes may be required to obtain a stable reading.
6. Relative (REL) mode can be used to zero the display before taking a measurement. Short press the REL button to null the display, the relative symbol (triangle) will appear. Short press the REL button again to exit the REL mode.

Fig. 7 – Capacitance Measurements

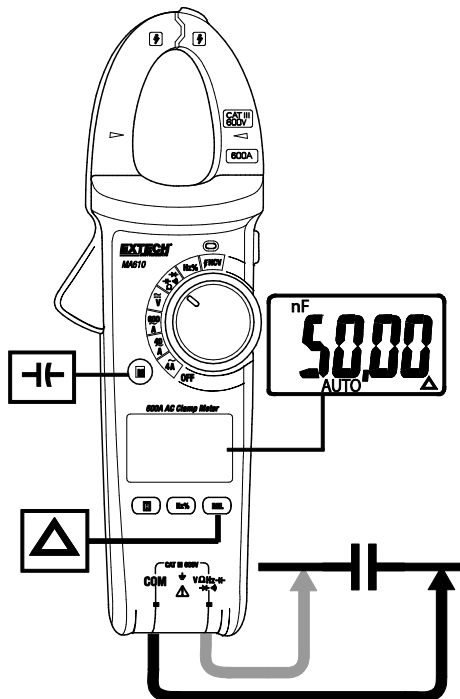

Diode Test

⚠️ WARNING: Please remove power to the circuit under test and discharge all capacitors before taking diode measurements. Do not input voltages > 30V DC or AC to the meter.

- 1. Turn the function switch to the **➡️⚡** position.
- 2. Use the **M** button to select the diode icon **➡️⚡**.
- 3. Insert the black test lead banana plug into the negative (COM) jack and the red test lead banana plug into the red (V) jack. See Fig. 8.
- 4. Touch the test probes to the diode under test, in both polarity directions one at a time.
- 5. Forward voltage will indicate 0.5 to 0.8V.
- 6. Reverse voltage will indicate "OL".
- 7. Shorted devices will indicate a reading close to '0' ohms in both directions.
- 8. An open device will indicate 'OL' in both directions.

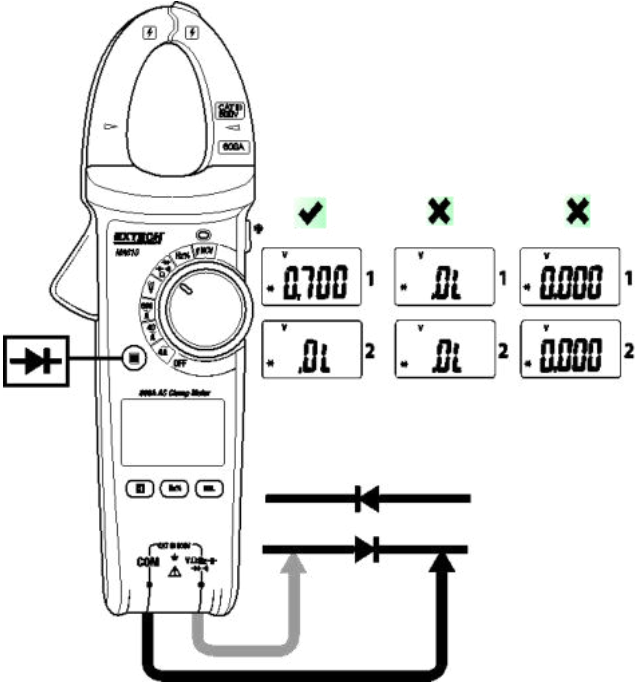

Fig. 8 – Diode Testing

Non-Contact Voltage-Detector (NCV)

The area at the top of the clamp jaws is used for sensing AC voltage.

When the electrical field is $> 100\text{V}$ and the distance is $< 10\text{mm}$ from the tip of the meter's clamp jaw, the beeper will sound and the red LED lamp will light.

The NCV lamp flashes at the same rate as the beeper. The higher the field strength, the faster the beep rate and lamp flashing.

When the sensed field is at highest levels, the meter's NCV lamp and beeper rate will become one continuous light and tone.

If the meter does not react as described above to an AC voltage, there is still the possibility that a voltage is present. **Please use caution.**

1. Move the function switch to the **NCV** position.
2. In this mode, the meter will display **'OL'** and **'NCV'**.
3. Place the meter near a source of electrical energy. The tip of the clamp offers the highest sensitivity.
4. Note the **beeping** and the **NCV lamp activation** when an AC Voltage is sensed.

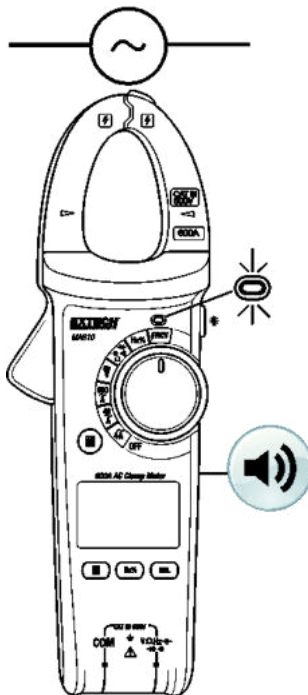

Fig. 9 – Non-Contact Voltage Detection

Maintenance



WARNING: To avoid electrical shock, disconnect the meter from any circuit and turn OFF the meter before opening the case. Do not operate with an open case.

Cleaning and Storage

Periodically wipe the case with a damp cloth and mild detergent; do not use abrasives or solvents. If the meter is not to be used for 60 days or more, remove the batteries and store them separately.

Battery Replacement

1. Remove the Phillips head screw at the back (near center) of the meter. See Fig. 10.
2. Open the battery compartment.
3. Replace the three (3) 1.5V 'AAA' batteries observing correct polarity.
4. Re-assemble the meter before use.
5. Safety: Please dispose of batteries responsibly; never dispose of batteries in a fire, batteries may explode or leak; never mix battery types, install new batteries of the same type.

Fig. 10 - BATTERY REPLACEMENT

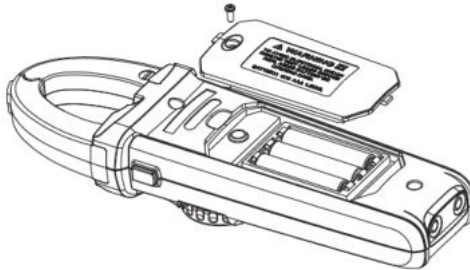

Never dispose of used batteries or rechargeable batteries in household waste.

As consumers, users are legally required to take used batteries to appropriate collection sites, the retail store where the batteries were purchased, or wherever batteries are sold.

Disposal: Do not dispose of this instrument in household waste. The user is obligated to take end-of-life devices to a designated collection point for the disposal of electrical and electronic equipment.

Cleaning and Storage

Periodically wipe the case with a damp cloth and mild detergent; do not use abrasives or solvents.

Specifications

Electrical Specifications

Accuracy is given as \pm (% of reading + least significant digits) at 23°C \pm 5°C with relative humidity \leq 75%. Accuracy is specified for a period of one year after calibration.

Temperature Coefficient is 0.1 x specified accuracy / °C, < 18°C (64.5°F), > 28°C (82.4°F)

Function	Range	Resolution	Accuracy (reading)	'OL' Protection
AC Current	4.000 A	0.001 A	\pm (2.5% + 30 digits)	600A
	40.00 A	0.01 A	\pm (2.5% + 5 digits)	
	600 A	1 A	\pm (2.0% + 9 digits)	
AC Voltage	4.000V	0.001V	\pm (1.2% + 5 digits)	600V AC/DC
	40.00V	0.01V		
	400.0V	0.1V	\pm (1.5% + 5 digits)	
	600V	1V		
DC Voltage	400.0mV	0.1mV	\pm (1.0% + 8 digits)	600V AC/DC
	4.000V	0.001V	\pm (0.8% + 1 digit)	
	40.00V	0.01V	\pm (0.8% + 3 digits)	
	400.0V	0.1V		
	600V	1V	\pm (1.0% + 3 digits)	
<i>Input Impedance: \geq 10MΩ</i>				
Resistance	400.0 Ω	0.1 Ω	\pm (1.2% + 2 digits)	600V AC/DC
	4.000k Ω	0.001k Ω	\pm (1.0% + 2 digits)	
	40.00k Ω	0.01k Ω		
	400.0k Ω	0.1k Ω	\pm (1.2% + 3 digits)	
	4.000M Ω	0.001M Ω		
	40.00M Ω	0.01M Ω	\pm (2.0% + 5 digits)	
<i>Open Circuit Voltage: Approx. 1.5V</i>				
Continuity	400.0 Ω	0.1 Ω	\pm (1.2% + 2 digits)	600V AC/DC
<i>Continuity: Beeper ON < 10Ω. Beeper OFF > 70Ω. Beeper unspecified >10Ω and <70Ω</i>				
Diode	4.000V	0.001V	Silicon PN junction 0.5 to 0.8V (typically)	600V AC/DC
<i>Open Circuit Voltage: Approx. 1.5V</i>				

Capacitance	50.00nF	0.01 nF	± (4.0% + 25 digits)	600V AC/DC
	500.0nF	0.1 nF	± (4.0% + 5 digits)	
	5.000 µF	0.001 µF		
	50.00 µF	0.01 µF		
	100.0 µF	0.1 µF		
Frequency (Hz)	10Hz~1MHz	0.01Hz~1kHz	± (0.1% + 4 digits)	600V AC/DC
Sensitivity: (10Hz~1MHz): 200mVrms ≤input amplitude ≤20Vrms				
Duty Cycle (%)	0.1 ~ 99.9%	0.1%	± (2.5%)	600V AC/DC
Input amplitude: 500mVrms ≤ Input amplitude ≤ 20Vrms; Duty Cycle applies to ≤10kHz Square Wave Specified accuracy range: 10% ~ 90% range				
Non-Contact Voltage Detector (NCV)	≥100Vrms; ≤10mm (0.4") beeper sounds, and NCV lamp lights			
<i>The tip of the meter offers optimum sensitivity</i>				

General Specifications

Display	LCD 4000-count multi-function backlit LCD
Polarity	Automatic display of positive and negative polarity
Over-range indication	“OL” or “-OL” is displayed
Conversion rate	3 updates per second
Clamp Sensor Type	Coil induction
Test position error	Additional error of $\pm 1.0\%$ of reading applies when the conductor under test is not positioned at the center of the clamp area
Jaw Opening	30mm diameter
Electromagnetic field influence	Unstable or inaccurate readings may be displayed if there is an electromagnetic field disturbance in the measurement environment
Maximum Voltage	600V AC/DC maximum applied to any terminal
Low battery indication	 is displayed
Auto Power OFF	After 30 minutes
Operating Temperature and Humidity	<p>0~30°C (32~86°F); 80%RH maximum</p> <p>30~40°C (86~104°F); 75%RH maximum</p> <p>40~50°C (104~122°F); 45%RH maximum</p>
Storage Temperature and Humidity	-20~60°C (-4~140°F); 80%RH maximum (with battery removed)
Operating Altitude	2000m (6562')
Battery power	3 x 1.5V 'AAA' alkaline batteries
Weight	265g (9.3 oz.) Including batteries
Dimensions (W x H x D)	77 x 228 x 41mm (3.0 x 9.0 x 1.6")
Drop Protection	1m (approx. 3')
Safety Standards	Indoor use only; Complies with EN61010-1, CAT III 600V; Pollution Degree 2



Copyright © 2016 FLIR Systems, Inc.

All rights reserved including the right of reproduction in whole or in part in any form

ISO-9001 Certified

www.extech.com