

FLIR MODEL DM284**True RMS Industrial Multimeter with IGM™**

Table of Contents

1. ADVISORIES	4
1.1 Copyright	4
1.2 Quality Assurance	4
1.3 Documentation	4
1.4 Disposal of Electronic Waste	4
2. SAFETY	4
3. INTRODUCTION	6
3.1 Key Features	6
4. METER DESCRIPTION AND REFERENCE GUIDE	7
4.1 Front and Back Meter Descriptions	7
4.2 Function Switch Positions	8
4.3 Function Buttons and Selector/Navigation Pad	9
4.3.1 MODE Button Operation	9
4.3.2 Selector/Navigation Pad Operation	10
4.4 Display Icons and Status Indicators	10
5. OPTIONS AND SETTINGS MENU	12
5.1 Using the Options and Settings Menus	12
5.2 Options and Settings Details	12
5.2.1 Image Mode Menu	12
5.2.2 Thermal Settings Menu	12
5.2.3 VFD Mode	13
5.2.4 Advanced Menu	13
5.2.5 MIN-MAX-AVG Mode	13
5.2.6 Peak Mode	14
5.2.7 Relative mode	14
5.2.8 Multimeter Settings Menu	14
6. METER POWER	16
6.1 Powering the Meter	16
6.2 Auto Power OFF (APO)	16
7. MULTIMETER OPERATION	17
7.1 Auto/Manual Range Mode	17
7.2 Probe Connection Alert	17
7.3 Out of Range Warning (OL)	17
7.4 Data Hold and Auto Hold	17
7.4.1 Data Hold Mode	17
7.4.2 Auto Hold Mode	17
7.5 Status Bar and Menu Icons	18

7.6 Test Lead Holder Accessory	19
7.7 Voltage and Frequency Measurements	20
7.8 Non-Contact Voltage Detector	21
7.9 Resistance Measurements	22
7.10 Continuity Test	23
7.11 Classic Diode Test	23
7.12 Smart Diode Test	25
7.13 Capacitance Measurements	26
7.14 Type K Temperature Measurements	27
7.15 Current and Frequency Measurements (A, mA, μ A)	28
7.15.1 Test Lead Current Measurements (A, mA, and μ A)	28
7.15.2 FLEX Clamp Adaptor Current and Frequency Measurements	31
8. IGM™ (INFRARED GUIDED MEASUREMENT) OPERATION	32
8.1 Thermal Camera IGM™ Basics	32
8.2 Thermal Settings Menu	34
8.3 Image Mode Menu	35
8.4 Status Bar Display Icons	35
8.5 Using the Multimeter in the IGM™ mode	36
8.6 Emissivity Factors for Common Materials	36
8.7 Infrared Energy and Thermal Imaging Overview	37
9. MAINTENANCE	38
9.1 Cleaning and Storage	38
9.2 Battery Replacement	38
9.3 Fuse Replacement	38
9.4 Disposal of Electronic Waste	38
10. SPECIFICATIONS	39
10.1 General specifications	39
10.2 Thermal Imaging Specifications	40
10.3 Electrical Specifications	41
11. TECHNICAL SUPPORT	46
12. WARRANTIES	47
12.1 FLIR Test & Measurement Imaging Product 10-year/10-year Warranty	47

1. Advisories

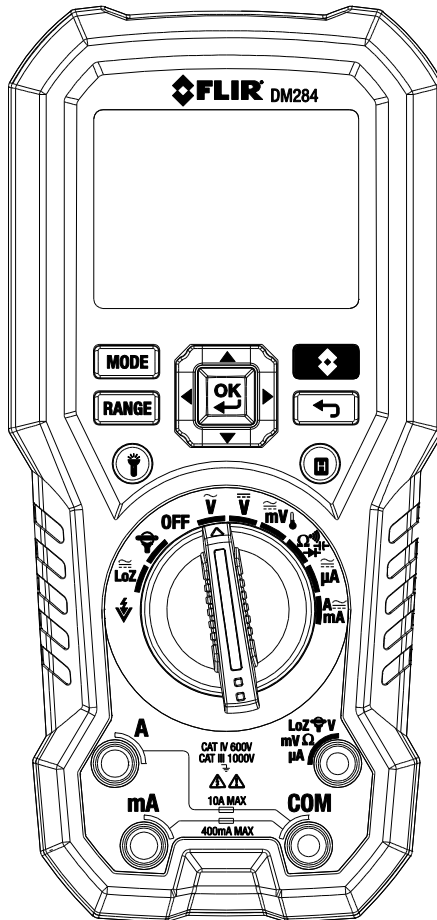
1.1 Copyright

© 2016, FLIR Systems, Inc. All rights reserved worldwide. No parts of the software including source code may be reproduced, transmitted, transcribed or translated into any language or computer language in any form or by any means, electronic, magnetic, optical, manual or otherwise, without the prior written permission of FLIR Systems. The documentation must not, in whole or part, be copied, photocopied, reproduced, translated or transmitted to any electronic medium or machine readable form without prior consent, in writing, from FLIR Systems.

Names and marks appearing on the products herein are either registered trademarks or trademarks of FLIR Systems and/or its subsidiaries. All other trademarks, trade names or company names referenced herein are used for identification only and are the property of their respective owners.

1.2 Quality Assurance

The Quality Management System under which these products are developed and manufactured has been certified in accordance with the ISO 9001 standard.

FLIR Systems is committed to a policy of continuous development; therefore, we reserve the right to make changes and improvements on any of the products without prior notice.

1.3 Documentation

To access the latest manuals and notifications, go to the Download tab at:

<http://support.flir.com>. It only takes a few minutes to register online. In the download area you will also find the latest releases of manuals for our other products, as well as manuals for our historical and obsolete products.

1.4 Disposal of Electronic Waste



As with most electronic products, this equipment must be disposed of in an environmentally friendly way, and in accordance with existing regulations for electronic waste.

Please contact your FLIR Systems representative for more details.

2. Safety

Safety Notes

- Before operating the device, you must read, understand, and follow all instructions, dangers, warnings, cautions, and notes.
- FLIR Systems reserves the right to discontinue models, parts or accessories, and other items, or to change specifications at any time without prior notice.
- Remove the batteries if the device is not to be used for an extended period of time.



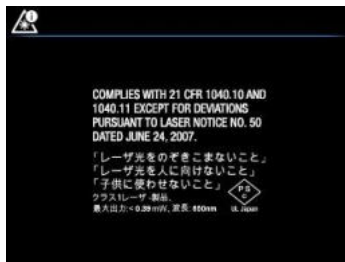

Warning Statements

- Do not operate the device if you do not have the correct knowledge. Incorrect operation of the device can cause damage, shock, injury or death to persons.
- Do not start a measuring procedure before you have set the function switch to the correct position. Failure to do so can cause damage to the instrument and can cause injury to persons.
- Do not change to the resistance mode when measuring voltage. This can cause damage to the instrument and can cause injury to persons.
- Do not measure the current on a circuit when the voltage increases to more than 1000 V. This can cause damage to the instrument and can cause injury to persons.
- You must disconnect the test leads from the circuit under test before you change the range. Failure to observe this warning can damage the instrument and cause bodily injury.
- Do not replace the batteries before you remove the test leads. This can cause damage to the instrument and can cause injury to persons.
- Do not use the device if the test leads and/or the device show signs of damage. Injury to persons can occur.
- Be careful performing measurements if the voltages are > 25 VAC rms or 35 VDC. There is a risk of shock from these voltages. Injury to persons can occur.
- Do not do diode, resistance or continuity tests before you have removed the power from capacitors and other devices under test. Injury to persons can occur.
- Be careful when performing voltage checks on electrical outlets. These checks are difficult because of the uncertainty of the connection to the recessed electrical contacts. You must not rely solely on this device when determining if the terminals are not “live”. There is a risk of electrical shock. Injury to person can occur.
- Do not touch expired/damaged batteries without gloves. Injury to persons can occur.
- Do not cause a short circuit of the batteries. This can cause damage to the instrument and can cause injury to persons.
- Do not put the batteries into a fire. Injury to persons can occur.
- Use extreme caution when the laser pointer is on.
- Do not point the beam toward anyone's eye or allow the beam to strike the eye from a reflective surface.
- Do not use the laser near explosive gases or in other potentially explosive areas.
- Refer to the CAUTION statement label (shown below) for critical safety information.



Cautions

Do not use the device in a manner not specified by the manufacturer. This can cause damage to the protection provided.

	This symbol, adjacent to another symbol or terminal, indicates that the user must refer to the user manual for further information.
	This symbol, adjacent to a terminal, indicates that, under normal use, hazardous voltages may be present.
	Double insulation.



UL listing is not an indication or a verification of the accuracy of the meter

3. Introduction

Thank you for selecting the FLIR DM284 True RMS Digital MultiMeter with IGM™ (Infrared Guide Measurement). The DM284 can measure voltage up to 1000V AC/DC and includes Low-Z (low impedance), VFD (low pass filter), and offers Smart/Classic Diode modes. This device is shipped fully tested and calibrated and, with proper use, will provide years of reliable service.

3.1 Key Features

- 6000 count 2.8" digital TFT display with bargraph
- Built-in IGM™ Infrared imager with laser pointer and crosshair targeting
- Measures Voltage, Current (A, mA, μ A), Frequency, Resistance/Continuity, Diode (Classic and Smart modes), Capacitance, and Temperature
- Built-in non-contact voltage detector (NCV)
- Customizable via easy-to-use menu system
- Automatic and Manual ranging
- Input over-voltage warning
- MIN-MAX-AVG memory
- PEAK MIN and PEAK MAX
- Flex Clamp direct input
- On-screen programming menu navigation
- Variable-frequency drive VFD mode (low-pass filter)
- Low-Z (low impedance) mode
- Relative mode
- Data Hold and Auto Hold
- Auto Power OFF
- Safety Category Rating: CAT IV-600V, CAT III-1000V.
- Equipped with batteries, test leads, alligator clips, test lead storage/holder attachment, Type-K thermocouple, and Quick Start booklet.

4. Meter Description and Reference Guide

4.1 Front and Back Meter Descriptions

Fig. 4-1 Front View

1. Work Light and NCV detector area
2. LCD Display
3. Navigation/OK buttons
4. MODE Button
5. RANGE Button
6. Work light Button
7. Rotary Function Switch
8. Positive (+) Probe Input Jack for A (Current).
9. Positive (+) Probe Input Jack for mA (Current).
10. COM (-) Probe Input Jack
11. Positive (+) Probe Input Jack for all inputs except A and mA
12. Display 'Hold' (H) button
13. Cancel/Return Button
14. IGM™ Button

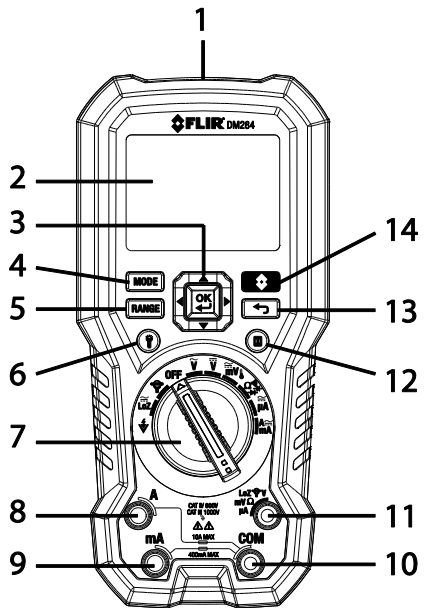

1. Test Lead holder attachment mounts
2. Thermal Imaging lens
3. Laser pointer lens
4. Lens cover slide control
5. Tripod mount (test lead holder attaches here also)
6. Tilt Stand (Battery Compartment located beneath the stand)

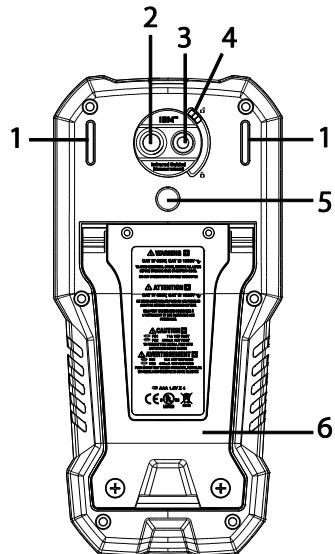

Fig. 4-2 Rear View

4.2 Function Switch Positions

















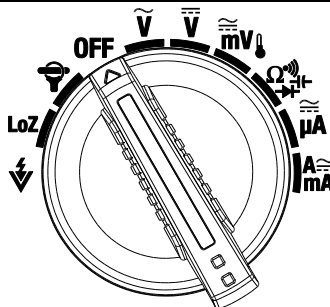

	Detect AC voltage through the non-contact sensor at the top of the meter.
	Measure voltage through the probe inputs with a low-impedance load positioned across the inputs that stabilizes the measurement.
OFF	Meter is switched OFF and in full power-saving mode.
	FLEX Direct: Auxiliary channel for use with optional Flexible Current clamp or standard clamp adaptors when > 600A measurements are required. In this mode, the meter will display true rms ACA measurements from the connected device. Frequency (Hz) can be displayed by pressing the MODE button.
	Measure AC voltage (V) through the probe inputs.
	Measure DC voltage (V) through the probe inputs.
	Measure low voltage (mV) through the probe inputs. Use the MODE button to select AC/DC voltage.
	Measure temperature through the probe inputs using a thermocouple adaptor. Use the MODE button to select Temperature (see Section 5.2.2, Thermal Settings Menu , to select °C or °F unit of measure).
	Measure resistance, continuity, capacitance, or diode through the probe inputs. Use the MODE button to select the desired function.
	Measure current through the probe inputs (A or mA). Use the MODE button to select AC or DC.
	Measure µA current through the probe inputs. Use the MODE button to select AC or DC.

Fig. 4-3 Function Switch



4.3 Function Buttons and Selector/Navigation Pad

	Use to select a sub-function of the primary function. See Section 4.3.1, MODE Button Operation , for details
	From Auto range mode, press to select Manual range mode. From Manual range mode, quick press to change the range (scale). Long press to activate Auto range mode
	Press to activate the Thermal Camera IGM™ (Infrared Guide Measurement)
	Use the selector/navigation pad to enable extended functionality modes and to navigate mode menu options
	Press to return from a menu screen (no function in normal mode).
	Press to enter the Hold mode (display hold or auto hold as selected in the Settings Menu see Section 5.2.8, Multimeter settings Menu)
	Press to enable/disable the work light.

4.3.1 MODE Button Operation

Rotary Switch Position	Switch Sequence
NCV	No operation
LoZ	ACV → DCV → Frequency
Flex	ACA → Frequency
ACV	ACV → Frequency
DCV	No operation
mV (Temperature)	ACmV → DCmV → Frequency → Temperature
Resistance	Resistance → Continuity → Capacitance → Diode
μA	ACμA → DCμA
A (A Terminal)	ACA → DCA → Frequency
mA (mA Terminal)	ACmA → DCmA → Frequency

4.3.2 Selector/Navigation Pad Operation

There are five (5) buttons arranged in a square that make up the Selector/Navigation pad, as shown in Figure 4-4.











Fig. 4-4 Selector Navigation Pad















OK button (center) is used to access the main menu and select/change menu options.

LEFT/RIGHT buttons: The left/right buttons are used to navigate the menus.

UP/DOWN buttons: The up/down buttons are used to navigate the menus.

4.4 Display Icons and Status Indicators

	Low Impedance mode
	Sensed voltage is > 30 V (AC or DC)
	Non-Contact Voltage detector (low sensitivity mode) for 160~1000V range
	Non-Contact Voltage detector (high sensitivity mode) for 80~1000V range
	MAX (Maximum) reading value displayed
	MIN (Minimum) reading value displayed
	AVG (Average) reading value displayed
	PEAK MAX value displayed
	PEAK MIN value displayed

	Auto range mode
	Display Hold
	Auto Hold
	Relative mode
0000	Primary display (large digits)
0000	Secondary display (smaller digits)
PROBE	Test lead connection error
ϵ	Emissivity setting
	Battery voltage status
	Auto power off function enabled
	AC current or voltage
	DC current or voltage
	Flex Clamp Direct Input
	Continuity function
	Diode test function
	Work light active
	Bar Graph Measurement Indicator
	Bar Graph OL (overload) Indicator

5. Options and Settings Menus

5.1 Using the Options and Settings Menus



- Press **OK** to open the main menu, Use the navigation pad arrows to step through the menu icons. From left to right, as shown below, they are Image Mode, Thermal Settings, VFD, Advanced Menu, and Multimeter Settings.



- Press **OK** to open a menu item or to set an option ON or OFF. When an option is switched ON, a blue dot will appear next to the menu icon. The navigation arrows are sometimes used to select an option.
- Use the Return/Exit button  to exit menu levels and to return to the normal display mode.
- The icons that are available differ in the Multimeter and IGM™ modes. The following information will detail this and other menu operations.

5.2 Options and Settings Details

5.2.1 Image Mode Menu

This icon is only available in the IGM™ mode. The Image Mode has two sub-menu selections: **Image + DMM mode**  and **Image Only mode** .

- Image + DMM (default option): Display will show all IR data and DMM data.
- Image Only: Display will show IR data only.
- For both options, the status bar will show Battery, APO, Work Light, and Laser icons when applicable.
- Image Mode option is disabled (grayed out) in DMM mode.

Press OK on the Image Mode icon and use the arrows to select **IGM + DMM** or **IMAGE**.

5.2.2 Thermal Settings Menu

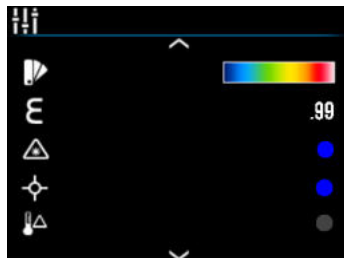

The following options are available in the Thermal Settings menu. More in-depth information may be found in the dedicated IGM section of this manual.

-  **IGM Color Palette selection.** Press **OK** to select one of the display color palettes (Iron, Rainbow, or Gray).



- **ε Emissivity:** Press OK then use the up/down arrows to scroll to the desired preset (0.95, 0.85, 0.75, 0.65) or to the fine tuning icon. To fine tune, press **OK** at the fine tuning icon and then use the arrow buttons to make a selection, press **OK** to confirm. The available range is 0.10 to 0.99 in 0.01 steps.



-  **Laser pointer:** Press **OK** at this icon to switch the laser pointer ON (blue circle icon) or OFF (empty circle icon).
-  **Cross hairs:** Press **OK** at this icon to switch the cross hairs ON or OFF.
-  **Temperature Differential:** Only available when you select **DMM IGM** in the Image Mode Menu (above) and **mV/Temp** on the rotary switch. Press **OK** to switch this mode ON (blue dot) or OFF. When ON, the display shows the Type K Thermocouple temperature and IGM mode temperature differential (delta).

5.2.3 VFD Mode

In VFD (variable-frequency drive) mode, high-frequency noise is eliminated from the Multimeter voltage measurement through the use of a low-pass filter. VFD mode is available when measuring AC voltage or AC current.



1. Press the **OK** button to access the menu. Press **OK** at the VFD icon to select.
2. The blue dot next to the icon and the VFD display icon will appear.
3. De-select the VFD mode by pressing **OK** again. The blue dot and VFD display icon will switch OFF when de-selected.

5.2.4 Advanced Menu

Press **OK** to open the Advanced Menu. Three selections are available: MAX-MIN-AVG, PEAK, and Relative Mode. The next three sections cover these features in detail.

5.2.5 MIN-MAX-AVG Mode

This mode is accessed through the Advanced Menu ; see previous section. The meter captures and displays the minimum, maximum, and average readings, updating only when a higher/lower value is registered. The meter also averages the total sum of all recorded values.

Press **OK** to show the maximum , minimum , and average  readings on the display.

5.2.6 Peak Mode **P**

This mode is accessed through the Advanced Menu, see above. In Peak mode, the meter captures and displays the positive and negative ACA and ACV peak values. The Peak display values changes only when higher/lower values are registered.

1. Press **OK** to show the Peak Max **↑** and Peak Min **↓** readings on the display.
2. Press **OK** to switch this mode OFF.

5.2.7 Relative mode **△**

This mode is accessed through the Advanced Menu, see above.

1. Press **OK** on this icon to capture a reference reading that subsequent measurements can be compared with.
2. A blue dot is shown next to the icon when this mode is selected.
3. The reference value will be displayed next to the Relative icon.
4. The primary display will show the difference between the measured value and the stored reference.
5. Press **OK** at this icon to switch the Relative mode OFF.

5.2.8 Multimeter Settings Menu **⚙️**

1. Press **OK** to open the main menu
2. Navigate to the Multimeter Settings icon **⚙️** using the arrow buttons
3. Open the Settings menu by pressing the **OK** button.
4. See the Settings menu example below. The items in the example may differ from the meter that you have depending on the firmware version. Customize the settings as described below:



- Diode **→|+** (Smart or Classic modes); see [Section 7.11, Classic Diode](#), and [Section 7.12, Smart Diode](#). Use the **OK** button to choose the desired setting.

- **⏻** Auto power off (APO): Press **OK** to open the sub-menu. Use the arrow buttons to choose the time period after which the meter enters sleep mode. Press **OK** to confirm the selection (a blue dot will appear next to the selection).

- **AUTO H** Auto hold: Use the **OK** button to toggle ON (blue dot) and OFF. For more information, see [Section 7.4, Data Hold and Auto Hold](#).

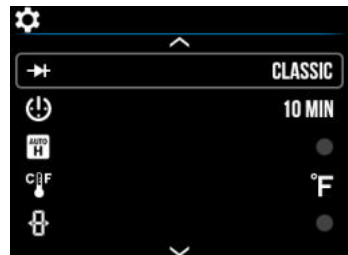
- **°C/°F** Temperature units. Use the **OK** button to toggle °C and °F.



-  Coarse Resolution (C.r. ON/OFF). Use the **OK** button to toggle ON (blue dot) and OFF. This function is for Voltage function only. The range and resolution for the Voltage function will change as follows when Coarse Resolution is enabled:
 - 600.0mV → 600mV
 - 6.000V → 6.00V
 - 60.00V → 60.0V
 - 600.0V → 600V
 - 1000V → 1000V
 - Default: OFF
- **Language:** Scroll to the desired language and press **OK**.
-  Help Screen: View the FLIR Customer Care contact information.
-  Information: View DMM, IGM, and Laser technical information.

6. Meter Power

6.1 Powering the Meter

1. Set the function switch to any position to switch on the meter.
2. If the battery indicator  shows that the battery voltage is low, if one of the Low Battery screens appears (shown below), or if the meter does not power on, replace the batteries. See [Section 9.2, Battery Replacement](#). If using the Model TA04 charging system, please recharge the rechargeable battery.

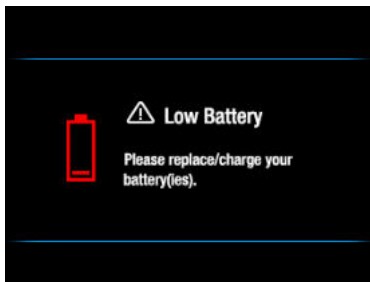
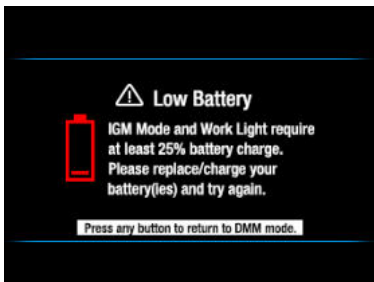

6.2 Auto Power OFF (APO)

The meter enters sleep mode after a programmable period of inactivity, to customize this setting please see [Section 5.2.8, Multimeter Settings Menu](#). The default time-out is 10 minutes. The time can be set from 1 ~ 10 minutes (select OFF to disable the APO). 20 seconds prior to entering APO mode, the meter beeps; at this point, press any button or turn the Rotary Switch to reset the APO timer.

7. MultiMeter Operation





Caution: Before operating the device, you must read, understand, and follow all instructions, dangers, warnings, cautions, and notes.

Caution: When the meter is not in use, the function switch should be set to the OFF position.

Caution: When connecting the probe leads to the device under test, connect the COM (negative) lead before connecting the positive lead. When removing the probe leads, remove the positive lead before removing the COM (negative) lead.

7.1 Auto/Manual Range Mode

In Auto range mode, the meter automatically selects the most appropriate measurement scale. In Manual range mode, the desired range (scale) can be adjusted by the user. Auto range mode is the default mode of operation. When a new function is selected with the function switch, the starting mode is Auto range and the  indicator is displayed.

1. To enter Manual range mode, short press the  button. To change the range, press the  button repeatedly until the desired range is displayed.
2. To return to the Auto range mode, long press the  button until the Auto Range  indicator is again displayed.

7.2 Probe Connection Alert

For current measurements, when the probe leads are not plugged into the correct jacks for the measurement selected by the function switch, the probe display alert 'PROBE' is shown.



7.3 Out of Range Warning (OL)

If the input is over/under the full-scale range in Manual range mode, or if the signal has exceeded the maximum/minimum input in Auto range mode, 'OL' is displayed.

7.4 Data Hold and Auto Hold

The meter has two HOLD modes: classic Data Hold and Auto Hold. To select Data Hold or Auto Hold as the default, please use the Settings menu ([see Section 5.2.8, Multimeter Settings Menu](#)). Refer to the paragraphs below for instructions on using the Hold modes.

7.4.1 Data Hold Mode

In Data Hold mode, the primary meter display freezes the last reading. To enter/exit Data Hold mode, press the  button. In Hold mode, the  indicator is displayed.

7.4.2 Auto Hold Mode

In Auto hold mode, the secondary display freezes the last reading and the  icon is displayed. The real-time reading is displayed on the primary display.

The held reading will not change unless the difference between the held reading and any new reading is > 50 digits.

The Auto hold function will capture a reading if the reading is > 1% full scale (trigger level) for Voltage, Current, and Capacitance. For Resistance, Diode, and Temperature the trigger is active as long as OL (over range).

To enter/exit Auto hold mode, press the **HOLD** button.

7.5 Status Bar and Menu Icons

The Status Bar is located at the top of the display and separated into two groups: Right and Left side groups.

The Right side group is located at the top right of the display. The icons are shown below, in [Section 4, Meter Description and Reference](#), and other relevant areas of this manual when applicable.



- Auto Hold
- Data Hold
- Auto Range
- VFD mode
- Low Impedance mode
- Work light
- Auto Power OFF (APO)
- Battery status

The Left side group is located at the top left of the display. The icons are shown below and other relevant areas of this manual when applicable.



- FLEX Clamp Adaptor icon
- FLEX Clamp Adaptor range
- Hazardous voltages present icon

There are 5 main options in the Menu bar. These are explained in some detail in [Section 5, Options and Settings Menus](#).



- Image Mode (available in IGM™ mode only)
- Thermal Settings (available in IGM™ mode only)
- VFD (low pass filter)
- Advanced Features Menu
- Multimeter Settings
- Use the Left / Right button to move the cursor
- Press the **OK** button to select an option.
- Up / Down buttons are not used for Menu bar operation.
- If an option is disabled (grayed) it is not available for the currently active mode.

7.6 Test Lead Holder Accessory

If desired, connect the supplied Test Lead Holder to the rear of the meter. The Test Lead Holder connects to the back of the meter (to items 1 and 5 as shown in Fig. 4-2 in [Section 4, Meter Description and Reference Guide](#)).

7.7 Voltage and Frequency Measurements

- Set the function switch to one of the following positions:
 - $\overline{\text{V}}$ (VDC) or $\widetilde{\text{V}}$ (VAC) for high voltage measurements.
 - $\overline{\text{mV}}$ (milli-volts) for low voltage measurements (use MODE to select AC or DC).
 - LoZ** for voltage measurements using the meter's low input impedance mode. The **LoZ** indicator will be displayed (use MODE to select AC or DC).
- Insert the black probe lead into the negative COM terminal and the red probe lead into the positive terminal.
- For **mV** and **LoZ** measurements use the **MODE** button to select AC or DC measurement:
 - The \sim indicator will be displayed for AC measurements.
 - The — — — indicator will be displayed for DC measurements.
- Connect the probe leads in parallel to the part under test.
- Read the voltage value on the display.
- The Frequency (Hz) of the measured voltage is shown on the smaller, secondary display digits above the primary voltage reading. Press the **MODE** button to view only the Frequency reading.
- Refer to [Section 5, Options and Settings Menu](#), for customizing the meter and using the VFD, MIN-MAX-AVG, Peak, and Relative modes of operation.

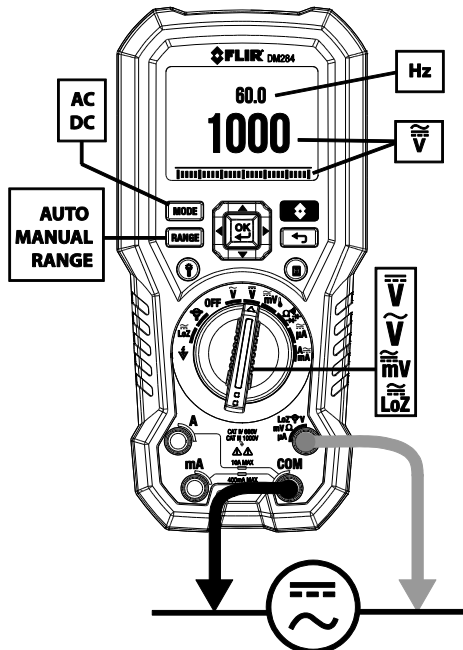





Fig. 7-1 Voltage and Frequency Measurements

7.8 Non-Contact Voltage Detector

1. Set the function switch to the NCV  position. See **Figure 7-2**.
2. Be sure to remove the test leads from the meter when doing NCV tests.
3. Use the **RANGE** button to choose High  (80~1000V) or Low  (160~1000V) Sensitivity mode.
4. Position the top of the meter close to a source of voltage or electromagnetic field.
5. When a voltage or electromagnetic field is detected the meter will emit a continuous tone and the displayed NCV icon will turn red in color and blink.

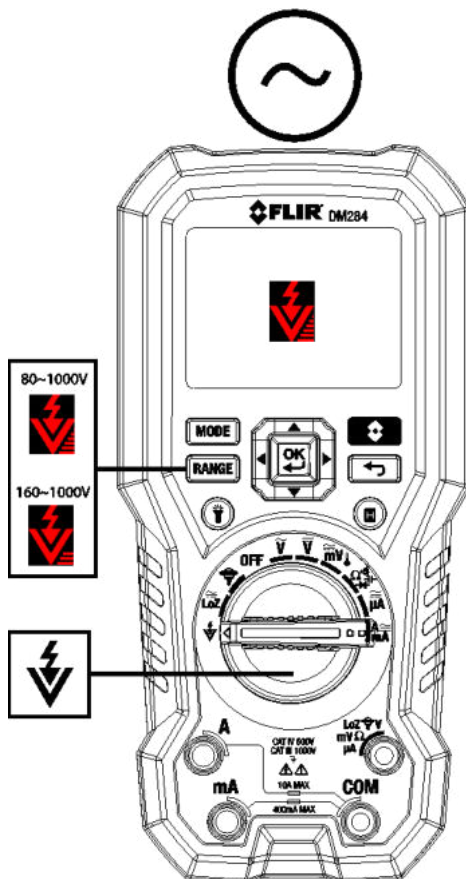



Fig. 7-2 Non-Contact Voltage Detector

7.9 Resistance Measurements

Warning: Do not perform diode, resistance or continuity tests before removing power from capacitors and other devices under test during a measurement. Injury to persons can occur.

1. Refer to **Fig. 7-3**. Set the function switch to the  position.
2. Use **MODE** to step to the Ω display if necessary.
3. Insert the black probe lead into the negative COM terminal and the red probe lead into the positive Ω terminal.
4. Touch the tips of the probe across the circuit or component under test.
5. Read the resistance value on the display.
6. Refer to [Section 5, Options and Settings Menus](#), for customizing the meter and using the MIN-MAX-AVG and Relative modes of operation.

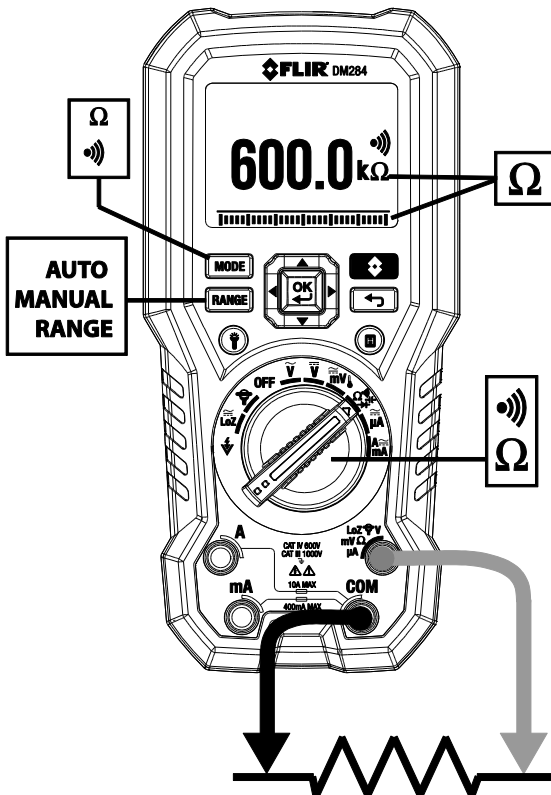





Fig. 7-3 Resistance and Continuity Measurements



7.10 Continuity Test

Warning: Do not perform diode, resistance or continuity tests before removing the power from capacitors and other devices under test during a measurement. Injury to persons can occur.

1. Refer to **Fig. 7-3**. Set the function switch to the  position.
2. Use the **MODE** button to select continuity. The  indicator will be displayed.
3. Insert the black probe lead into the negative COM terminal and the red probe lead into the positive  terminal.
4. Touch the tips of the probe across the circuit or component under test.
5. If the resistance is $< 20\Omega$ the meter beeps. If the resistance is $> 200\Omega$ the meter will not beep. $> 20\Omega$ but $< 200\Omega$ the beeping will stop at an unspecified point.

7.11 Classic Diode Test

Warning: Do not perform diode tests before removing the power to the diode or other devices under test during a measurement. Injury to persons can occur.

1. If not already selected, choose CLASSIC Diode test mode in the Settings menu ([Section 5.2.8, Multimeter Settings Menu](#)).
2. Set the function switch to the diode  position. Use the MODE button to select the diode test function. The diode indicator  will be displayed.
3. Insert the black probe lead into the negative COM terminal and the red probe lead into the positive terminal.
4. Touch the tips of the probe across the diode or semiconductor junction under test in one polarity (direction) and then in the opposite polarity as shown in **Fig. 7-4**.
5. If the reading is between 0.400 and 0.800V in one direction and OL (overload) in the opposite direction, the component is good. If the measurement is 0V in both directions (shorted) or OL in both directions (open), the component is bad.

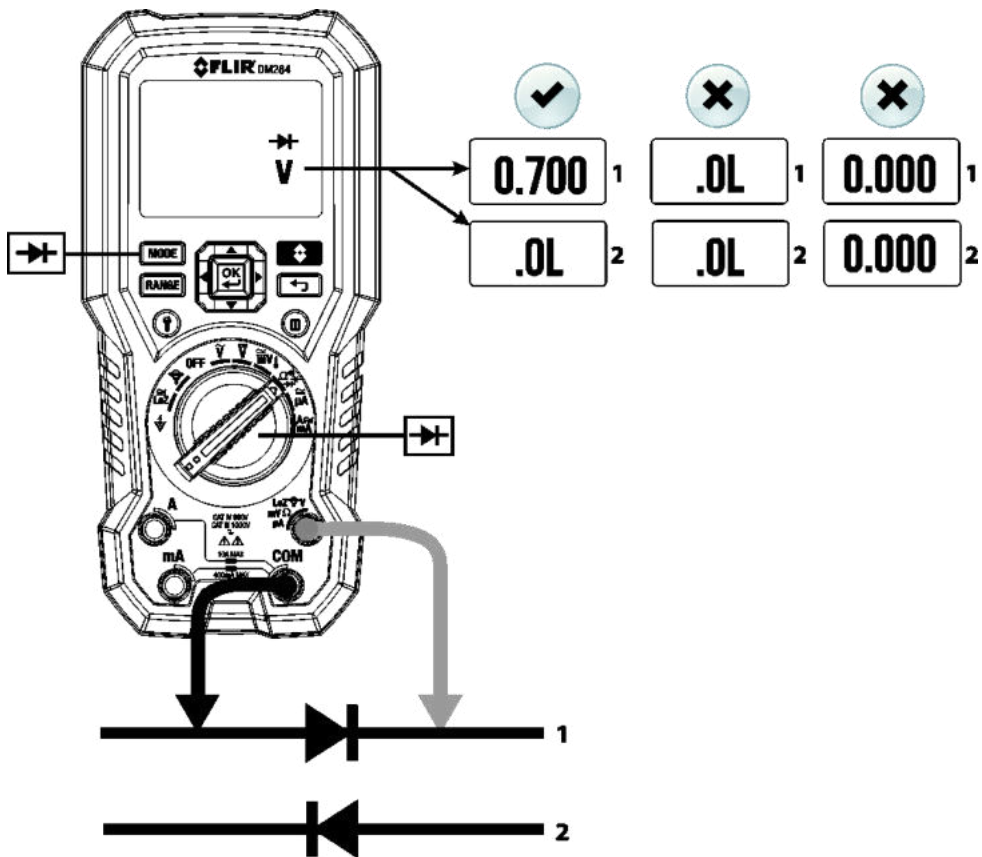



Fig. 7-4 Classic Diode Test

7.12 Smart Diode Test

Warning: Do not perform diode tests before removing the power from capacitors and other devices under test during a measurement. Injury to persons can occur.

1. If not already selected, choose SMART Diode test mode in the Multimeter Settings menu ([Section 5.2.8, Multimeter Settings Menu](#)).
2. Set the function switch to the diode  position. Use the MODE button to select the diode test function. The diode indicator  will be displayed.
3. Insert the black probe lead into the negative COM terminal and the red probe lead into the positive Ω terminal.
4. Touch the tips of the probe across the diode or semiconductor junction under test.
5. If the reading is between $\pm 0.400 \sim 0.800V$, the component is good; BAD or O.L displays indicate a defective component.

NOTES: In SMART Diode mode the meter checks diodes using an alternating test signal sent through the diode in both directions. This allows the user to check the diode without having to reverse polarity manually. The meter display will show $\pm 0.400 \sim 0.800V$ for a good diode, 'BAD' for a shorted diode, and 'O.L.' for an opened diode. See **Fig. 7-5** below:

Fig. 7-5 SMART Diode Test

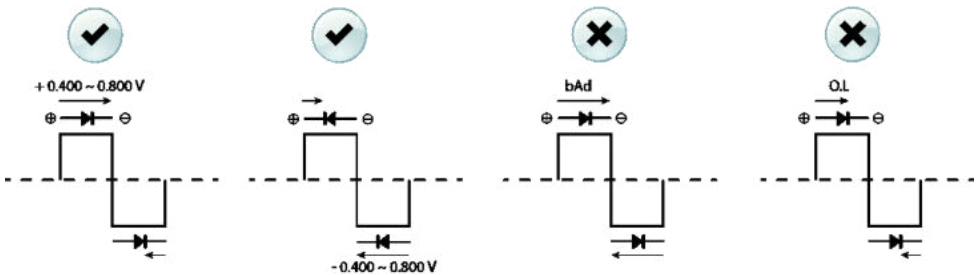

7.13 Capacitance Measurements

Warning: Do not perform capacitance tests before removing power to the capacitor or other devices under test during a measurement. Injury to persons can occur.

1. Set the function switch to the  position.
2. Use the **MODE** button to select the capacitance measurement. The F (Farad) unit of measure will be displayed.
3. Insert the black probe lead into the negative COM terminal and the red probe lead into the positive terminal.
4. Touch the tips of the probe across the part under test.
5. Read the capacitance value on the display.
6. Refer to [Section 5, Options and Settings Menus](#), for customizing the meter and using the MIN-MAX-AVG and Relative modes of operation.

Note: For very large capacitance values, it may take several minutes for the measurement to settle and the final reading to stabilize.

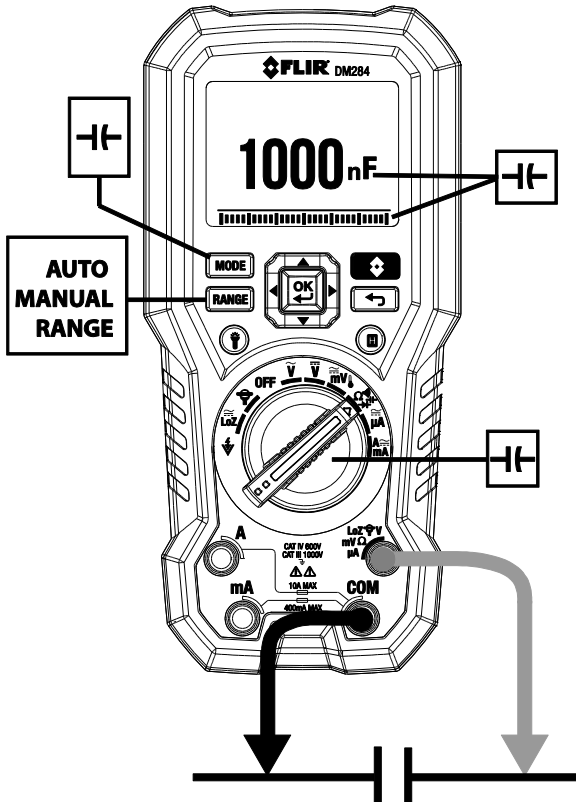

Fig. 7-6 Capacitance Measurements

7.14 Type K Temperature Measurements

1. Set the function to the Temperature t position.
2. Use the **MODE** button to select temperature measurement. The $^{\circ}\text{F}$ or $^{\circ}\text{C}$ unit will be displayed. To change from F to C or from C to F, please use the Multimeter Settings menu ([Section 5.2.8, Multimeter Settings Menu](#)).
3. While observing the polarity, insert the thermocouple adapter into the negative terminal and the positive terminal.
4. Touch the tip of the thermocouple to the part under test. Keep the thermocouple tip on the part until the reading stabilizes.
5. Read the temperature value on the display.
6. To avoid electrical shock, disconnect the thermocouple adapter before turning the function switch to another position.

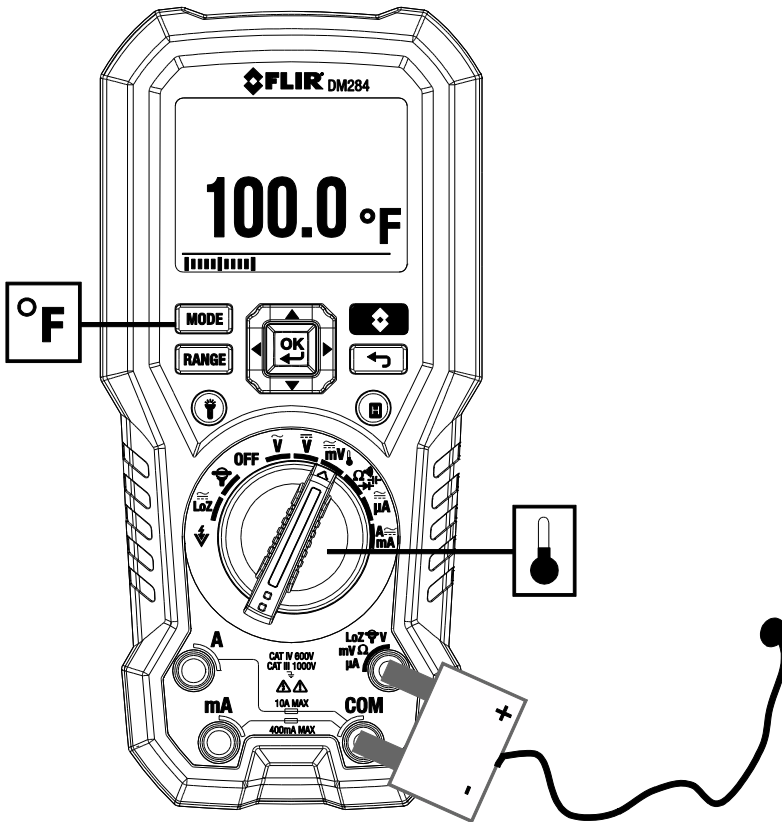

Fig. 7-7 Temperature Measurements



7.15 Current and Frequency Measurements (A, mA, μ A)

For test lead current measurements, disconnect the part under test and connect the test leads in series with the part, see **Figure 7-8**.



Fig. 7-8 Disconnected component

7.15.1 Test Lead Current Measurements (A, mA, and μ A)

1. For test lead measurements (A, mA, and μ A), set the function switch to the **A** or **mA** position.
2. Insert the black probe lead into the negative COM terminal and the red probe lead into one of the following positive terminals:
 - **A** for high current measurements.
 - **mA** for lower current measurements.
 - **μ A** for micro-amp measurements
3. Use the **MODE** button to select AC or DC measurement.
 - The  indicator will be displayed for AC measurements.
 - The  indicator will be displayed for DC measurements.
4. Connect the probe leads in series with the part in accordance with **Fig. 7-8** and **Fig. 7-9** for 'A' measurements, **Fig. 7-10** for mA measurements, or **Fig. 7-11** for μ A measurements.
5. Read the current and frequency values on the display. Frequency (Hz) is available only in the **A AC** and **mA AC** modes. Use the **MODE** to view the Frequency only.
6. Refer to [Section 5, Options and Settings Menus](#), for customizing the meter and using the VFD, MIN-MAX-AVG, Peak, and Relative modes of operation.

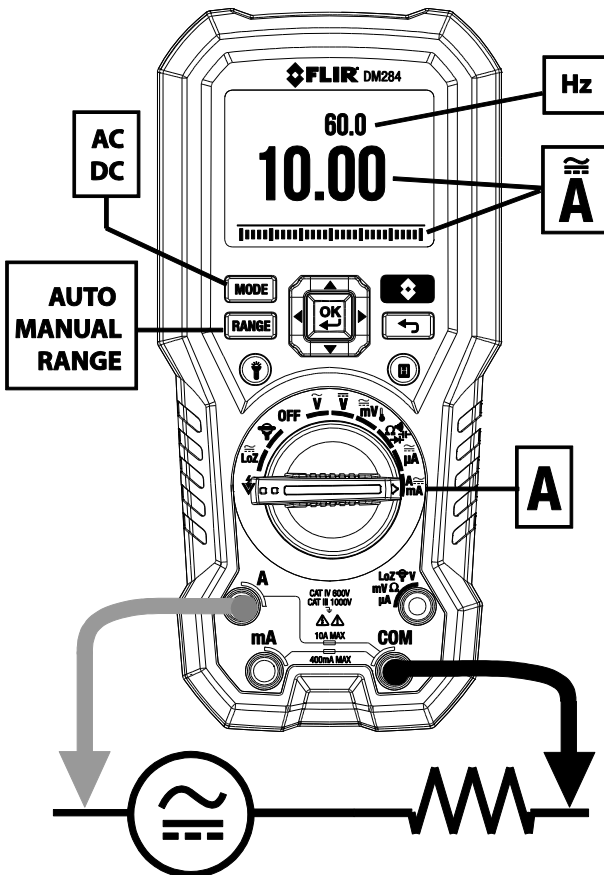

Fig. 7-9 High Current 'A' Measurements

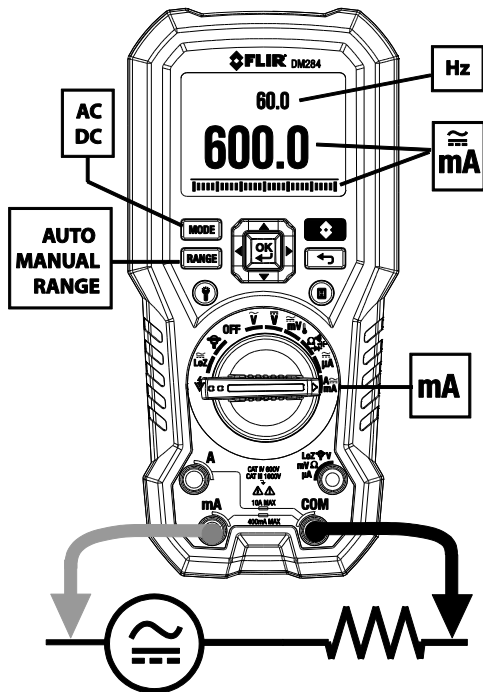

Fig. 7-10 mA Current Measurements

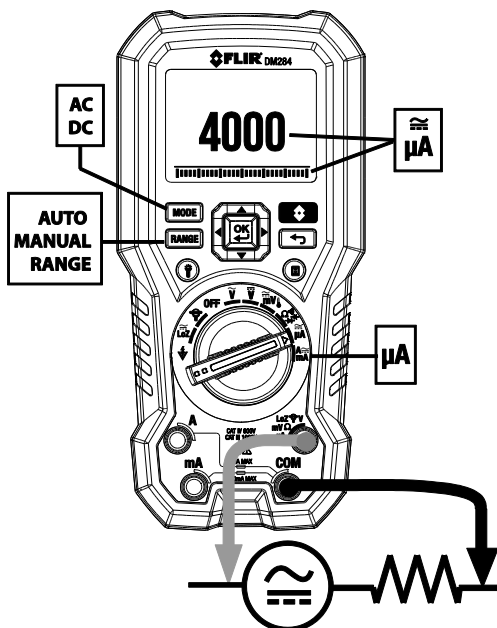



Fig. 7-11 uA Current Measurements

7.15.2 FLEX Clamp Adaptor Current and Frequency Measurements

FLIR Flex Clamp Adaptors (Models TA72 and TA74, for example) and other clamp adaptors can be connected to the DM284 to display current measurements made by a clamp adaptor.

1. Turn the function dial to the  position.
2. Connect a Clamp adaptor as shown in **Fig. 7-12**.
3. Set the Range of the Flex Clamp Adaptor to match the range of the DM284.
4. Use the RANGE button to select the range of the DM284 (1, 10, 100 mV/A). The selected range will be shown on the right side of the DM284 display.
5. Operate the Flex Clamp per instructions provided with the Flex Clamp meter.
6. Read the current measured by the Flex Clamp on the DM284 LCD. The frequency is also shown on the DM284's secondary display.

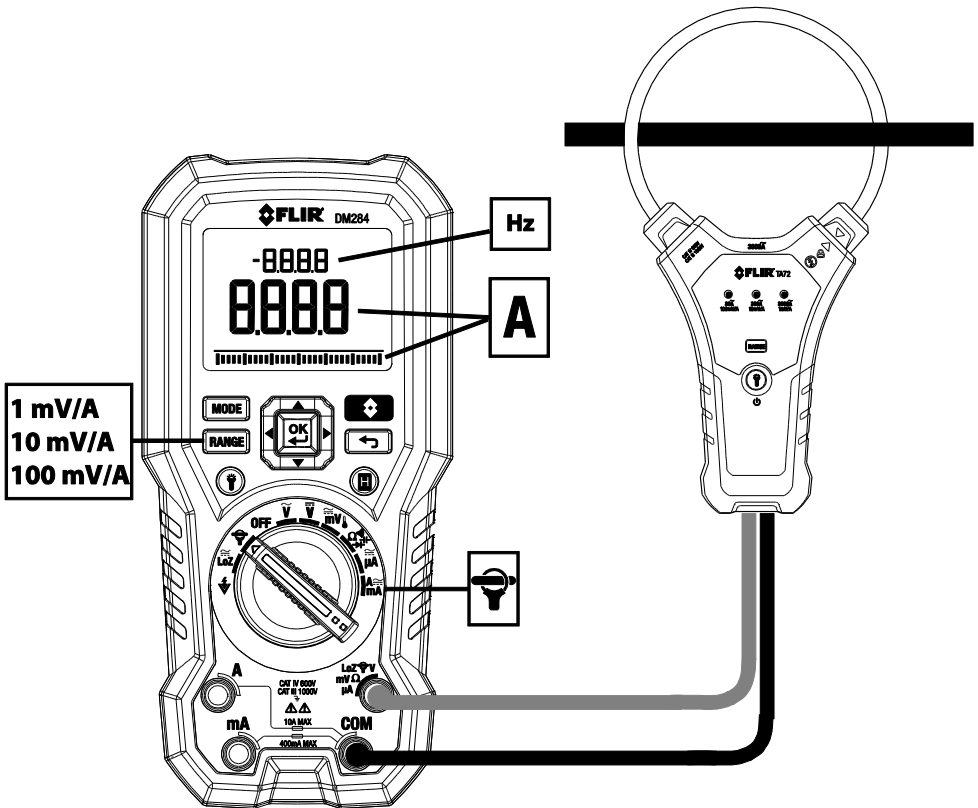

Fig. 7-12 FLEX Clamp Application

8. IGM™ (Infrared Guided Measurement) Operation

8.1 Thermal Camera IGM™ Basics

In the Thermal Imaging mode, the user can measure a targeted surface's temperature. This is accomplished by detecting the energy emitted by the surface under test. A thermal image of the area under test is viewed in the same manner as with dedicated thermal imaging devices, where color variations reflect temperature variations. See [Section 8.7, Infrared Energy and Thermal Imaging Theory](#) for in-depth information. The laser pointer and display cross hairs assist in targeting.

- **Press the IGM button to open the Thermal Imager.** In **Fig 8-1** the meter is set to color palette IRON. Select other palettes in the Thermal Settings Menu.
- Open the protective lens cover on the back of the meter. The protective lens cover can easily be slid up (open) or down (closed) by hand. See [Section 4, Meter Description and Reference Guide](#) for exact position of rear cover.

Fig. 8-1 IGM Display Example

1. **IGM Temperature measurement** represents the temperature of the spot sensed. Note that while the temperature reading is stabilizing dashes will be displayed temporarily.

2. The currently selected **Emissivity (ε)** value. Use the Thermal Settings Menu to change the emissivity setting. See [Section 8.6, Emissivity Factors for Common Materials](#).

3. **Status Bar Icon area**

4. **Highest reading** measured in the current frame

5. The **Thermal scale** shows the range of colors for thermal images. The lighter the color, the warmer the temperature; the darker the color, the cooler the temperature.

6. **Lowest reading** measured in the current frame.

7. **Menu Bar area**

8. **Cross hairs** for surface targeting.

9. **Thermal image frame**

10. **DMM measurement** is shown below the temperature measurement. Set the meter to show Multimeter readings superimposed on the image in the Image Mode menu.

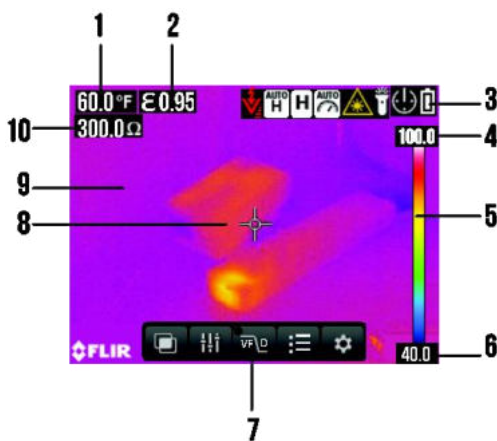

To customize the Thermal Imager, refer to [Section 5.2.2, Thermal Settings Menu](#). For basic operation follow these steps:

1. Set the function switch to any position.
2. Press the IGM button to switch the IGM Thermal Imager ON. Point the thermal imaging lens (located on the rear of the meter) toward an area to measure.
3. The display will show the temperature measurement in the upper left hand corner for the targeted area along with the currently selected emissivity value.
4. In the Thermal Imaging mode, the laser pointer and display cross hairs can be used to assist in targeting. These tools can be switched ON or OFF in the Thermal Settings Menu.
5. In the Thermal imaging mode, the meter continues to operate normally as a Multimeter allowing any of the electrical functions to be used. Note that in the Thermal Imaging mode the electrical functions are shown on the left side of the display and can be switched off if desired in the Image Mode menu.
6. The Distance to Spot ratio for the imager is 30:1 meaning that the measurement spot is 30 times smaller than the distance from meter to spot (at a distance of 30", the meter 'sees' a target spot of 1"). **See Fig. 8-2.**
7. The thermal imager's FOV (Field of View) is 50 degrees (top view) and 38.6 degrees (side view), see **Fig. 8-3 (a) and (b)**.

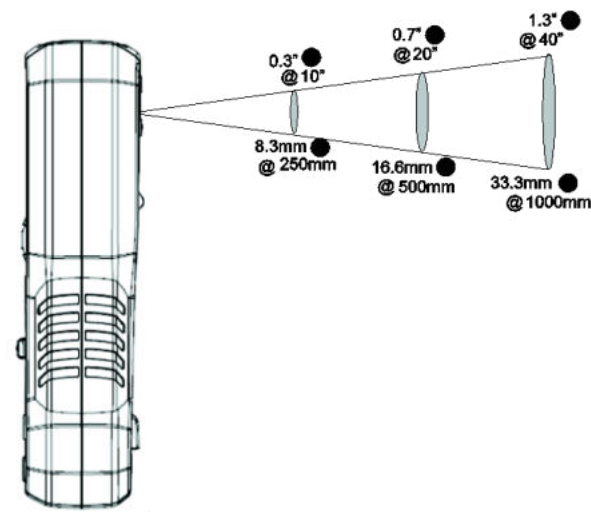

Fig. 8-2 Distance-to-Spot ratio 30:1

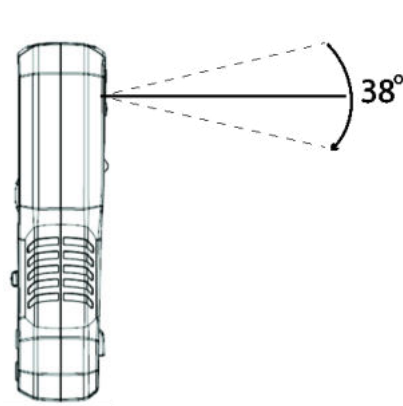

Fig. 8-3 (a) Field of View – side view

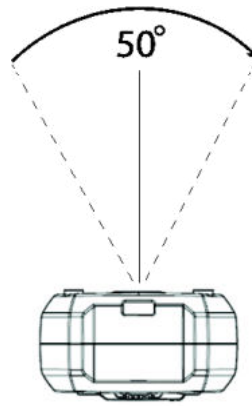



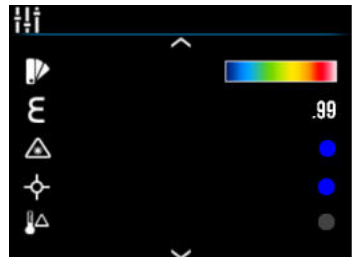



Fig. 8-3 (b) Field of View - top view

8.2 Thermal Settings Menu

Press **OK** to open the main menu and then press **OK** on the Thermal Settings icon. See the Thermal Settings screenshot example and descriptions below.

- 
IGM Color Palette selection. Press **OK** to select one of the display color palettes (Iron, Rainbow, or Gray).
- 
Emissivity: Press **OK** then use the up/down arrows to scroll to the desired preset (0.95, 0.85, 0.75, 0.65) and press **OK**. To fine tune, press **OK** at the fine tuning icon (located below the presets) and then use the arrow buttons to make a selection. The available range is 0.10 to 0.99 in 0.01 steps.
- 
Laser pointer: Press **OK** at this icon to switch the laser pointer ON (blue dot next to icon) or OFF.



- 
Cross hairs: Press **OK** at this icon to switch the IGM target cross hairs ON or OFF.
- 
Temperature Differential: Thermocouple temperature minus IGM temperature. Only available when **Image + DMM** is selected in the Image Mode Menu (see next section) and **mV/Temp** is selected with the rotary switch. Press **OK** to switch this mode ON or OFF.

In **Fig. 8-4**, the 3rd row shows a differential temperature of 5.0°F (IGM temperature is 85.0°F and the Type-K temperature is 80.0°F in the example). See [Section 7.14, Type-K Temperature Measurements](#) for Type-K measurements.



Fig. 8-4 Type-K / IGM Temperature Differential Reading Example

8.3 Image Mode Menu

Press **OK** to open the Main menu and then press **OK** on the Image Mode icon.

Select **Image + DMM**  mode or **Image Only** mode  from the Image Mode menu using the arrow buttons.

- Image + DMM (default mode): Display will show all IR data and DMM data.
- Image Only: Display will show IR data only.
- For both options, the status bar will show Battery, APO, Work Light, and Laser icons when applicable.

8.4 Status Bar Display Icons

The Status Bar is located at the top-right corner. There are 2 rows of icons as shown. The icons are always on the right side of the display and in the same sequence. From top left to right these Status Bar icons are: Auto Hold, Data Hold, Auto Range, Laser Pointer, Work light, APO, battery status, VFD, FLEX clamp input/range, and Low Impedance mode (LoZ). For details on these, please refer to [Section 4, Meter Description and Reference Guide](#) and [Section 7, Multimeter Operation](#).



To customize the display layout please refer to [Section 5, Settings and Options Menus](#).

8.5 Using the Multimeter in the IGM™ mode

The Multimeter can be used as described in [Section 7, Multimeter Operation](#) while the IGM™ mode is active. Multimeter readings, status bar icons, and operational modes such as PEAK, RELATIVE, and MIN-MAX-AVG can be viewed directly on top of the thermal image when **IMAGE + DMM** mode is selected in the Image Mode menu (see [Section 5.2.1, Image Mode Menu](#)).

8.6 Emissivity Factors for Common Materials

Material	Emissivity	Material	Emissivity
Asphalt	0.90 to 0.98	Cloth (black)	0.98
Concrete	0.94	Skin (human)	0.98
Cement	0.96	Leather	0.75 to 0.80
Sand	0.90	Charcoal (powder)	0.96
Soil	0.92 to 0.96	Lacquer	0.80 to 0.95
Water	0.92 to 0.96	Lacquer (matt)	0.97
Ice	0.96 to 0.98	Rubber (black)	0.94
Snow	0.83	Plastic	0.85 to 0.95
Glass	0.90 to 0.95	Timber	0.90
Ceramic	0.90 to 0.94	Paper	0.70 to 0.94
Marble	0.94	Chromium Oxides	0.81
Plaster	0.80 to 0.90	Copper Oxides	0.78
Mortar	0.89 to 0.91	Iron Oxides	0.78 to 0.82
Brick	0.93 to 0.96	Textiles	0.90

8.7 Infrared Energy and Thermal Imaging Overview

A thermal imager generates an image based on temperature differences. In a thermal image the hottest item in the scene appears as white and the coldest item as black, and all other items are represented as a gray scale value between white and black.

It may take some time to get used to the thermal imagery. Having a basic understanding of the differences between thermal and daylight cameras can help with getting the best performance from the DM284.

One difference between thermal and daylight cameras has to do with where the energy comes from to create an image. When viewing an image with an ordinary camera, there has to be some source of visible light (something hot, such as the sun or lights) that reflects off of the objects in the scene to the camera. The same is true with human eyesight; the vast majority of what people see is based on reflected light energy. On the other hand, the thermal imager detects energy that is directly radiated from objects in the scene.

This is why hot objects such as parts on an engine and exhaust pipes appear white, while the sky, puddles of water and other cold objects appear dark (or cool). Scenes with familiar objects will be easy to interpret with some experience.

Infrared energy is part of a complete range of radiation called the electromagnetic spectrum. The electromagnetic spectrum includes gamma rays, X-rays, ultraviolet, visible, infrared, microwaves (RADAR), and radio waves. The only difference is their wavelength or frequency. All of these forms of radiation travel at the speed of light. Infrared radiation lies between the visible and RADAR portions of the electromagnetic spectrum.

The primary source of infrared radiation is heat or thermal radiation. Any object that has a temperature radiates in the infrared portion of the electromagnetic spectrum. Even objects that are very cold, such as an ice cube, emit infrared. When an object is not quite hot enough to radiate visible light, it will emit most of its energy in the infrared. For example, hot charcoal may not give off light, but it does emit infrared radiation, which we feel as heat. The warmer the object, the more infrared radiation it emits.

Infrared imaging devices produce an image of invisible infrared or “heat” radiation that is unseen by the human eye. There are no colors or “shades” of gray in infrared, only varying intensities of radiated energy. The infrared imager converts this energy into an image that we can interpret.

The Infrared Training center offers training (including online training) and certification in all aspects of thermography: <http://www.infraredtraining.com/>.

9. Maintenance

9.1 Cleaning and Storage

Wipe the housing with a damp cloth as needed. Use a high quality lens wipe to remove dirt or smudges from the meter lenses and display window. Please do not use abrasives or solvents to clean the meter housing, lenses, or display window.

If the meter is not to be used for an extended period, remove the batteries and store them separately.

9.2 Battery Replacement

The Battery symbol flashes with no 'bars' when the batteries have reached a critical level. The meter displays readings within specifications while the low battery indicator is on. The meter powers off before it displays an out of tolerance reading.

WARNING: To avoid electrical shock, disconnect the meter from any connected circuits, remove the test leads from the meter terminals, and set the function switch to the OFF position before attempting to replace the batteries.

1. Unscrew and remove the battery compartment cover.
2. Replace the four (4) standard AAA batteries, observing correct polarity.
3. If using the Model TA04 rechargeable lithium polymer battery system, please recharge the rechargeable battery.
4. Secure the battery compartment cover.

9.3 Fuse Replacement

The two fuses are accessed via the battery compartment. The fuses are rated:

- mA: 440 mA, 1000 V IR 10 kA fuse (Bussmann DMM-B-44/100).
- A: 11 A, 1000 V IR 20 kA fuse (Bussmann DMM-B-11A).
- Fuse kit PN: FS881, contains one of each fuse type.

9.4 Disposal of Electronic Waste

As with most electronic products, this equipment must be disposed of in an environmentally friendly way, and in accordance with existing regulations for electronic waste. Please contact your FLIR Systems representative for more details.

10. Specifications

10.1 General specifications

Maximum voltage:	1000 V DC or 1000 V AC RMS
Display Counts:	6000
Polarity Indication:	Automatic, positive implied, negative indicated
Over-range Indication:	OL
Measuring Rate:	3 samples per second
Power Requirements:	4 x 1.5 V AAA alkaline or lithium batteries or optional Model TA04 lithium polymer rechargeable battery system <ul style="list-style-type: none">• Battery Type: Alkaline 'AAA' Battery x 4<ul style="list-style-type: none">○ Battery Life: approximately 9 hours (DMM) or 2 hours (IGM)• Battery Type Energizer L92 Ultimate Lithium 'AAA' Battery x 4<ul style="list-style-type: none">○ Battery Life: approximately 11.5 hours (DMM) or 5.5 hours (IGM)• Optional Rechargeable Battery Type: 3000mA Li-Polymer FLIR PN: TA04-KIT<ul style="list-style-type: none">○ Battery Life: approximately 30 hours (DMM) or 12 hours (IGM)
Auto Power Off:	Default 20 minutes
Operating Temp/RH:	14°F to 86°F (-10°C to 30°C), < 85% RH 86°F to 104°F (30°C to 40°C), < 75% RH 104°F to 122°F (40°C to 50°C), <45% RH
Storage Temperature/RH:	-4°F to 140°F (-20°C to 60°C), 0-80% RH (without batteries)
Temperature Coefficient:	0.1 x (specified accuracy)/°F, < 64.4°F (18°C), >82.4°F (28°C)
Operating Altitude:	6560' (2000m)
Calibration Cycle:	One year
Weight:	18.9 oz. (537g)
Dimensions:	(L x W x H) 7.9 x 3.7 x 1.9 in. (200 x 95 x 49mm)
Safety:	Complies with IEC 61010-1 CAT IV-600 V, CAT III-1000V

CAT	Application Field
I	Circuits not connected to mains.
II	Circuits directly connected to a low-voltage installation.
III	Building installation.
IV	Source of the low-voltage installation.

EMC: EN 61326-1

Pollution degree: 2

Drop protection: 3m (9.8')

Max. Operating Altitude: 2000m (6562 ft.)

Vibration: Random Vibration per MILPRF28800F Class 2

10.2 Thermal Imaging Specifications

IR Temperature Range	14 ~ 302°F (-10 ~ 150°C)
IR Temperature Resolution	0.1°F/C
Image Sensitivity	< or equal to 150mK (0.15°C)
IR Temperature Accuracy	3°C or 3% whichever is greater (>77°F [25°C]) or 9°F (5°C) (14~77°F [-10 to 25°C])
Emissivity	0.95 maximum (4 presets and a fine tuning feature)
Distance to Spot ratio	30:1
Response time	150ms
Spectral Response	8~14um
Scanning type	Continuous
Repeatability	0.5%
Image Detector	Lepton
Field of View (FOV)	120 x 160 pixels (50°)
Color Palettes	Iron, Rainbow, and Greyscale
Laser type	Class 1
Laser power	< 0.4mW

10.3 Electrical Specifications

Accuracy is given as \pm (% of reading + counts of least significant digit) at 73.4°F \pm 9°F (23°C \pm 5°C), with relative humidity < 80%

Temperature coefficient: $0.1 * (\text{Specified accuracy}) / ^\circ\text{F}$, < 64.4°F (18°C), > 82.4°F (28°C)

AC Function notes:

- ACV and ACA are ac coupled, true RMS.
- For all AC functions, LCD displays 0 counts when the reading < 10 counts.
- For square waves, accuracy is unspecified.
- For non-sinusoidal waveforms, additional accuracy for Crest Factor (C.F.):
 - Add 1.0% for C.F. 1.0 to 2.0
 - Add 2.5% for C.F. 2.0 to 2.5
 - Add 4.0% for C.F. 2.5 to 3.0
- Max. Crest Factor of Input Signal:
 - 3.0 @ 3000 counts
 - 2.0 @ 4500 counts
 - 1.5 @ 6000 counts
- Frequency Response is specified for sine waveform.

DC Voltage

Range	OL Reading	Resolution	Accuracy
6.000V	6.600V	0.001V	$\pm(0.09\% + 2D)$
60.00V	66.00V	0.01V	
600.0V	660.0V	0.1V	
1000V	1100V	1V	

Input Impedance: 10M Ω

Overload Protection: AC/DC 1000V

AC Voltage

Range	OL Reading	Resolution	Accuracy	Freq. Response
6.000V	6.600V	0.001V	$\pm(1.0\% + 3D)$	45Hz ~ 500Hz
60.00V	66.00V	0.01V	$\pm(1.0\% + 3D)$	45Hz ~ 1kHz
600.0V	660.0V	0.1V		
1000V	1100V	1V		

Input Impedance: 10M Ω (< 100pF)

Overload Protection: AC/DC 1000V

Lo-Z Voltage (Auto AC & DC Detection)

Range	OL Reading	Resolution	Accuracy
600.0V DC & AC	660.0V	0.1V	±(2.0% + 3D)
1000V DC & AC	1100V	1V	

Input Impedance: about 3kΩ

Frequency Response: 45 ~ 1kHz (Sine Wave)

Overload Protection: AC/DC 1000V

DC mV

Range	OL Reading	Resolution	Accuracy
600.0mV	660.0mV	0.1mV	±(0.5% + 2D)

Input Impedance: 10MΩ

Overload Protection: AC/DC 1000V

AC mV

Range	OL Reading	Resolution	Accuracy
600.0mV	660.0mV	0.1mV	±(1.0% + 3D)

Frequency Response: 45 ~ 1kHz (Sine Wave)

Input Impedance: 10MΩ

Overload Protection: AC/DC 1000V

DC Current

Range	OL Reading	Resolution	Accuracy
60.00mA	66.00mA	0.01mA	±(1.0% + 3D)
400.0mA	660.0mA	0.1mA	
6.000A	6.600A	0.001A	±(1.0% + 3D)
10.00A	20.00A	0.01A	

The accuracy of measurements > 10A is unspecified.

Maximum measurement time: > 5A for max. 3 minutes with at least 20-minute rest time.

> 10A for max.30 seconds with at least 10-minute rest time.

Overload Protection: AC/DC 11A for A terminal. AC/DC 660mA for mA terminal.

AC Current

Range	OL Reading	Resolution	Accuracy
60.00mA	66.00mA	0.01mA	±(1.5% + 3D)
400.0mA	660.0mA	0.1mA	
6.000A	6.600A	0.001A	±(1.5% + 3D)
10.00A	20.00A	0.01A	

Accuracy of readings > 10A is unspecified.

Maximum measurement time: > 5A for max. 3 minutes with at least 20-minute rest time.

> 10A for max. 30 seconds with at least 10-minute rest time.

Frequency Response: 45 ~ 1kHz (Sine Wave)

Overload Protection: AC/DC 11A for A terminal. AC/DC 660mA for mA terminal.

DC μ A

Range	OL Reading	Resolution	Accuracy
400.0 μ A	440.0 μ A	0.1 μ A	±(1.0% + 3D)
4000 μ A	4400 μ A	1 μ A	

Input Impedance: approx. 2k Ω

Overload Protection: AC/DC 1000V

AC μ A

Range	OL Reading	Resolution	Accuracy
400.0 μ A	440.0 μ A	0.1 μ A	±(1.0% + 3D)
4000 μ A	4400 μ A	1 μ A	

Input Impedance: approx. 2k Ω ; Frequency Response: 45 ~ 1kHz (Sine Wave)

Overload Protection: AC/DC 1000V

Resistance

Range	OL Reading	Resolution	Accuracy
600.0 Ω	660.0 Ω	0.1 Ω	±(0.9% + 5D)
6.000k Ω	6.600k Ω	0.001k Ω	±(0.9% + 2D)
60.00k Ω	66.00k Ω	0.00k Ω	±(0.9% + 2D)
600.0k Ω	660.0k Ω	0.1k Ω	±(0.9% + 2D)
6.000M Ω	6.600M Ω	0.001M Ω	±(0.9% + 2D)
50.00M Ω	55.00M Ω	0.01M Ω	±(3.0% + 5D)

Overload Protection: AC/DC 1000V

Continuity

Range	OL Reading	Resolution	Accuracy
600.0Ω	660.0Ω	0.1Ω	±(0.9% + 5D)

Continuity: Built-in beeper sounds when measured resistance is less than 20Ω and is off when measured resistance is more than 200Ω. Between 20Ω and 200Ω the beeper will stop at an unspecified point.

Continuity Indicator: 2KHz Tone Buzzer; Response Time of Buzzer: < 500μsec.

Overload Protection: AC/DC 1000V

Diode

Range	OL Reading	Resolution	Typical Reading
1.500V	1.550V	0.001V	0.400 ~ 0.800V

Open Circuit Voltage: Approx. 1.8V; Overload Protection: AC/DC 1000V

Frequency

Range	OL Reading	Resolution	Accuracy
100.00Hz	100.00Hz	0.01Hz	±(0.1% + 2D)
1000.0Hz	1000.0Hz	0.1Hz	
10.000kHz	10.000kHz	0.001kHz	
100.00kHz	100.00kHz	0.01kHz	

ACV - Minimum Sensitivity (including LoZ ACV):

Range	5Hz ~ 1kHz	1kHz ~ 10kHz	>10kHz
600.0mV	60mV	100mV	Unspecified
6.000V	0.6V	6V	Unspecified
60.00V	6V	10V	Unspecified
600.0V	60V	100V	Unspecified
1000V	600V	Unspecified	Unspecified

ACA - Minimum Sensitivity:

Range	5Hz ~ 10kHz	>10kHz
60.00mA	10mA	Unspecified
600.0mA	60mA	Unspecified
6.000A	2A	Unspecified
10.00A	2A	Unspecified

FLEX Clamp Adaptor Current - Minimum Sensitivity:

Range	5Hz ~ 10kHz	>10kHz
30.00A	3.00A (0.300V)	Unspecified
300.0A	30.0A (0.300V)	Unspecified
3000A	300A (0.300V)	Unspecified

Minimum Frequency: 5Hz

Overload Protection: AC/DC 1000V or 600A

Capacitance

Range	OL Reading	Resolution	Accuracy
1000nF	1100nF	1nF	±(1.9% + 5D)
10.00µF	11.00µF	0.01µF	±(1.9% + 2D)
100.0µF	110.0µF	0.1µF	
1.000mF	1.100mF	0.001mF	
10.00mF	11.00mF	0.01mF	

Overload Protection: AC/DC 1000V

Flex Current

Range	OL Reading	Resolution	Accuracy
30.00A	33.00A	0.01A	±(1.0% + 3D)
300.0A	330.0A	0.1A	
3000A	3300A	1A	

Accuracy does not include the accuracy of the Flexible Clamp Meter.

Frequency Response: 45 ~ 1kHz (Sine Wave)

Overload Protection: AC/DC 1000V

Type-K Temperature

Range	OL Reading	Resolution	Accuracy (DMM)	Accuracy (IGM)
-40.0°C to 400.0°C	≤ -44.0°C, ≥ 440.0°C	0.1°C	± (1% + 3°C)	± (1% + 5°C)
-40.0°F to 752.0°F	≤ -44.0°F, ≥ 824.0°F	0.1°F	± (1% + 5.4°F)	± (1% + 9°F)

The accuracy applies with a 30-minute warmup time and is unspecified when the Work Light is ON.

Accuracy does not include the accuracy of the thermocouple probe.

Accuracy specification assumes surrounding temperature stable to ±1.8°F (±1°C). For surrounding temperature changes of ± 2 °C, rated accuracy applies after 2 hours.

Overload Protection: AC/DC 1000V.

NCV (Non-Contact Voltage Detector)

Voltage Range (High Sensitivity): 80V to 1000V

Voltage Range (Low Sensitivity): 160V to 1000V

Peak Max and Peak Min Hold

For ACV, AC mV, ACA, ACmA, AC μ A, and Flex Current modes (unavailable for LoZ mode)

Specified accuracy \pm 150 digits for < 6000 counts

Specified accuracy \pm 250 digits for \geq 6000 counts

VFD (Low Pass Filter)

For ACV, AC mV, ACA, ACmA, AC μ A, and Flex Current modes (unavailable for LoZ mode)

Specified accuracy is for 45Hz ~ 65Hz

Specified accuracy \pm 4% for 65Hz ~ 400Hz

Accuracy is unspecified for > 400Hz

Cut-off Frequency: 800Hz (\pm 100Hz)

Work Light

Color Temperature: 4000-5000°K

Beam Angle: \pm 20°

Light Output: 70 lumens, minimum

Power: 0.5 Watt RMS

11. Technical Support

Main Website	http://www.flir.com/test
Technical Support Website	http://support.flir.com
Technical support Email	TMSupport@flir.com
Service/Repair Support Email	Repair@flir.com
Support Telephone number	+1 855-499-3662 option 3 (toll-free)

12. Warranties

12.1 FLIR Test & Measurement Imaging Product 10-year/10-year Warranty

Congratulations! You (the “Purchaser”) are now the owner of a world-class FLIR Imaging Test and Measurement product. A qualifying FLIR Imaging Test and Measurement product (the “Product”) purchased either directly from FLIR Commercial Systems Inc. and affiliates (FLIR) or from an authorized FLIR distributor that Purchaser registers on-line with FLIR is eligible for coverage under FLIR’s industry-leading 10-10 Limited Warranty, subject to the terms and conditions in this document. This warranty only applies to purchases of Qualifying Products (see below) purchased after September 2015 and only to the original Purchaser of the Product.

PLEASE READ THIS DOCUMENT CAREFULLY; IT CONTAINS IMPORTANT INFORMATION ABOUT THE PRODUCTS THAT QUALIFY FOR COVERAGE UNDER THE 10-10 LIMITED WARRANTY, PURCHASER’S OBLIGATIONS, HOW TO ACTIVATE THE WARRANTY, WARRANTY COVERAGE, AND OTHER IMPORTANT TERMS, CONDITIONS, EXCLUSIONS AND DISCLAIMERS.

1. **PRODUCT REGISTRATION.** To qualify for FLIR’s 10-10 Limited Warranty, the Purchaser must fully register the Product directly with FLIR on-line at www.flir.com WITHIN Sixty (60) DAYS of the date the Product was purchased by the first retail customer (the “Purchase Date”). PRODUCTS THAT ARE NOT REGISTERED ON-LINE WITHIN Sixty (60) DAYS OF THE PURCHASE DATE OR PRODUCTS WHICH DO NOT QUALIFY FOR THE 10-10 WARRANTY WILL HAVE A LIMITED ONE YEAR WARRANTY FROM THE DATE OF PURCHASE.
2. **QUALIFYING PRODUCTS.** Upon registration, a list of thermal Imaging Test and Measurement Products that qualify for coverage under FLIR’s 10-10 Warranty can be found at www.flir.com/testwarranty
3. **WARRANTY PERIODS.** The 10-10 Limited Warranty has two separate periods of warranty coverage (the “Warranty Period”), depending on the Imaging Test and Measurement Product part:

Product components are warranted for a period of ten (10) years from the Purchase Date;

Thermal imaging sensor is warranted for a period of ten (10) years from the Purchase Date.

Any Product that is repaired or replaced under warranty is covered under this 10-10 Limited Warranty for one hundred eighty days (180) days from the date of return shipment by FLIR or for the remaining duration of the applicable Warranty Period, whichever is longer.

4. **LIMITED WARRANTY.** In accordance with the terms and conditions of this 10-10 Limited Warranty, and except as excluded or disclaimed in this document, FLIR warrants, from the Purchase Date, that all fully registered Products will conform to FLIR’s published Product specifications and be free from defects in materials and workmanship during the applicable Warranty Period. PURCHASER’S SOLE AND EXCLUSIVE REMEDY UNDER THIS WARRANTY, AT FLIR’S SOLE DISCRETION, IS THE REPAIR OR REPLACEMENT OF DEFECTIVE PRODUCTS IN A MANNER, AND BY A SERVICE CENTER, AUTHORIZED BY FLIR. IF THIS REMEDY IS ADJUDICATED TO BE INSUFFICIENT, FLIR SHALL REFUND PURCHASER’S PAID PURCHASE PRICE AND HAVE NO OTHER OBLIGATION OR LIABILITY TO BUYER WHATSOEVER.

5. **WARRANTY EXCLUSIONS AND DISCLAIMERS.** FLIR MAKES NO OTHER WARRANTY OF ANY KIND WITH RESPECT TO THE PRODUCTS. ALL OTHER WARRANTIES, EXPRESS OR IMPLIED, INCLUDING BUT NOT LIMITED TO IMPLIED WARRANTIES OF MERCHANTABILITY, FITNESS FOR A PARTICULAR PURPOSE (EVEN IF PURCHASER HAS NOTIFIED FLIR OF ITS INTENDED USE FOR THE PRODUCTS), AND NON-INFRINGEMENT ARE EXPRESSLY EXCLUDED FROM THIS AGREEMENT.

THIS WARRANTY EXPRESSLY EXCLUDES ROUTINE PRODUCT MAINTENANCE, AND SOFTWARE UPDATES. FLIR FURTHER EXPRESSLY DISCLAIMS ANY WARRANTY COVERAGE WHERE THE ALLEGED NONCONFORMITY IS DUE TO NORMAL WEAR AND TEAR OTHER THAN SENSORS, ALTERATION, MODIFICATION, REPAIR, ATTEMPTED REPAIR, IMPROPER USE, IMPROPER MAINTENANCE, NEGLIGENCE, ABUSE, IMPROPER STORAGE, FAILURE TO FOLLOW ANY PRODUCT INSTRUCTIONS, DAMAGE (WHETHER CAUSED BY ACCIDENT OR OTHERWISE), OR ANY OTHER IMPROPER CARE OR HANDING OF THE PRODUCTS CAUSED BY ANYONE OTHER THAN FLIR OR FLIR’S EXPRESSLY AUTHORIZED DESIGNEE.

THIS DOCUMENT CONTAINS THE ENTIRE WARRANTY AGREEMENT BETWEEN PURCHASER AND FLIR AND SUPERSEDES ALL PRIOR WARRANTY NEGOTIATIONS, AGREEMENTS, PROMISES AND UNDERSTANDINGS BETWEEN PURCHASER AND FLIR. THIS WARRANTY MAY NOT BE ALTERED WITHOUT THE EXPRESS WRITTEN CONSENT OF FLIR.

6. WARRANTY RETURN, REPAIR AND REPLACEMENT. To be eligible for warranty repair or replacement, Purchaser must notify FLIR within thirty (30) days of discovering of any apparent defect in materials or workmanship. Before Purchaser may return a Product for warranty service or repair, Purchaser must first obtain a returned material authorization (RMA) number from FLIR. To obtain the RMA number Owner must provide an original proof of purchase. For additional information, to notify FLIR of an apparent defect in materials or workmanship, or to request an RMA number, visit www.flir.com. Purchaser is solely responsible for complying with all RMA instructions provided by FLIR including but not limited to adequately packaging the Product for shipment to FLIR and for all packaging and shipping costs. FLIR will pay for returning to Purchaser any Product that FLIR repairs or replaces under warranty.

FLIR reserves the right to determine, in its sole discretion, whether a returned Product is covered under warranty. If FLIR determines that any returned Product is not covered under warranty or is otherwise excluded from warranty coverage, FLIR may charge Purchaser a reasonable handling fee and return the Product to Purchaser, at Purchaser's expense, or offer Purchaser the option of handling the Product as a non-warranty return. FLIR shall not be responsible for any data, images or other information that may be stored on the returned Product which was not included in the Product at the time of purchase. It is Purchaser's responsibility to save any and all data prior to returning the Product for warranty service.

7. NON-WARRANTY RETURN. Purchase may request that FLIR evaluate and service or repair a Product not covered under warranty, which FLIR may agree to do in its sole discretion. Before Purchaser returns a Product for non-warranty evaluation and repair, Purchaser must contact FLIR by visiting www.flir.com to request an evaluation and obtain an RMA. Purchaser is solely responsible for complying with all RMA instructions provided by FLIR including but not limited to adequately packaging the Product for shipment to FLIR and for all packaging and shipping costs. Upon receipt of an authorized non-warranty return, FLIR will evaluate the Product and contact Purchaser regarding the feasibility of and the costs and fees associated with Purchaser's request. Purchaser shall be responsible for the reasonable cost of FLIR's evaluation, for the cost of any repairs or services authorized by Purchaser, and for the cost of repackaging and returning the Product to Purchaser. Any non-warranty repair of a Product is warranted for one hundred eighty days (180) days from the date of return shipment by FLIR to be free from defects in materials and workmanship only, subject to all of the limitations, exclusions and disclaimers in this document.



Corporate Headquarters
FLIR Systems, Inc.
2770 SW Parkway Avenue
Wilsonville, OR 97070
USA
Telephone: +1 503-498-3547

Customer Support
Technical Support Website
Technical Support Email
Service and Repair Email
Customer Support Telephone

<http://support.flir.com>
TMSupport@flir.com
Repair@flir.com
+1 855-499-3662 option 3 (toll free)

Publication Identification No.: DM284-en-US
Release Version: AC
Release Date: 2017 January
Language: en-US