

FLIR VT8 Series

Voltage, Continuity, and Current Testers

VT8-600 and VT8-1000

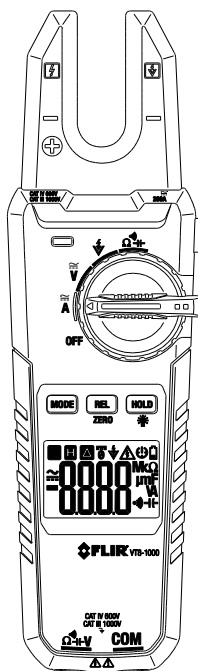
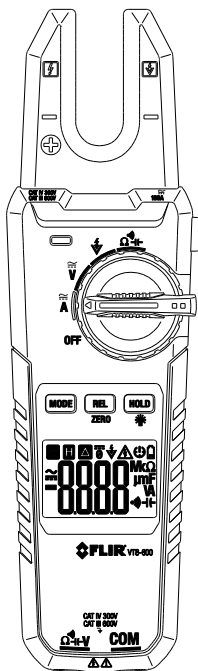

Introduction

The True RMS VT8 Series measures AC/DC Voltage, AC/DC Current, Resistance, Continuity, and Capacitance and has a Non-Contact Voltage Detector (NCV). Features include Data Hold, Relative/Zero, Worklight, backlit LCD and APO (auto power off). The VT8-1000 (CAT III 1000V/CATIV 600V) is rated for 1000V/200A and the VT8-600 (CAT III 600V/CAT IV 300V) is rated for 600V/100A.

To obtain the detailed User Manual (multi-languages) please visit www.support.flir.com (Download tab under Help and Support). Please read the user manual carefully before use.

This product is protected by FLIR's 3-Year Limited Warranty. Visit www.flir.com/testwarranty to read the Warranty document. Register your product at the website to receive a free 1-year warranty extension.

Meter Description

1. Non-Contact Voltage Detector
2. Jaw opening
3. NCV alert LED
4. Worklight button
5. Rotary function switch
6. Relative/Zero button
7. MODE button
8. HOLD/Backlight button
9. LCD Display
10. Test lead jacks

Battery compartment, test lead holders, and Worklight on back of meter

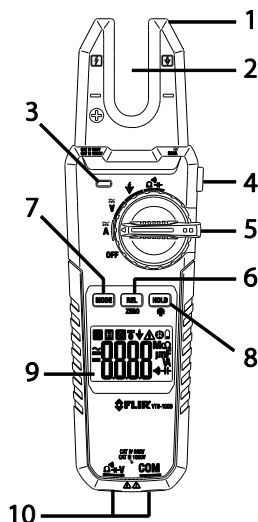





Button Descriptions

REL/ZERO: Short press to enter/exit the Relative mode (for ACV/DCV, ACA, and Capacitance). For DCA, short press to ZERO, long press to exit ZERO mode

H : Short press for Data Hold ON/OFF. Long press for low intensity LCD backlight; long press again for high intensity light; long press again to switch light OFF

MODE: Short press to perform the functions shown in the table below

| Switch Position | MODE Button Functions |
|---|---|
|  | AC < > DC |
|  | AC < > DC |
|  | Ω >  >  > |

Rotary Switch

OFF: Meter power OFF position. Move the switch to any other position to power ON. Replace batteries if meter fails to power ON. APO turns the meter OFF automatically after 15 minutes of inactivity.



A: AC/DC Current (press **MODE** to choose AC or DC)



V: AC/DC Voltage (press **MODE** to choose AC or DC)



V: Non-Contact Voltage Detector (NCV)



Ω  : Resistance/Continuity/Capacitance (press **MODE** to select function)

Battery Replacement

Turn the meter OFF and disconnect the test leads. Remove the rear compartment screw. Replace two 'AA' batteries observing correct polarity. Reassemble meter before use.

Display Description

1. Auto Range
2. Data Hold
3. Relative mode
4. DCA Zero
5. Non-Contact Volt Detector (NCV)
6. Electrical signals detected
7. Auto Power OFF (APO) active
8. Battery status
9. Unit of measure and function icons
10. Main display digits
11. Minus (negative) sign
12. DC (direct current)
13. AC (alternating current)

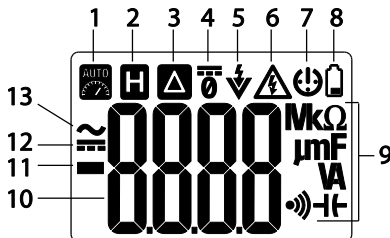

Measurements

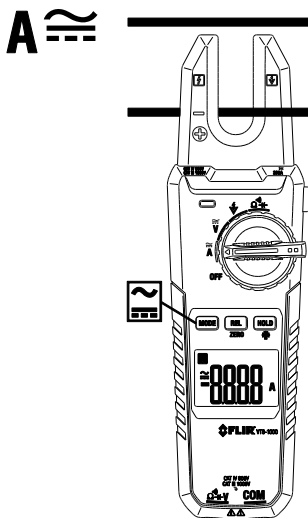
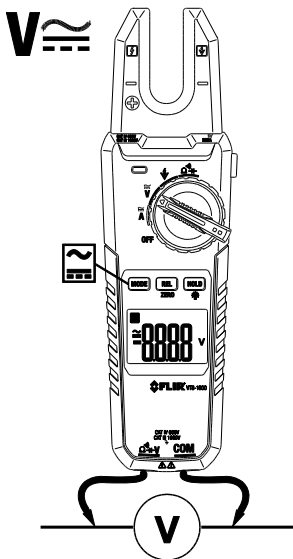

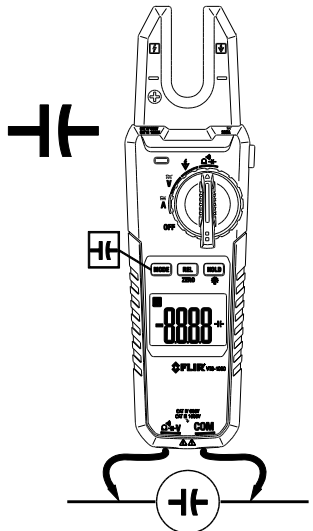
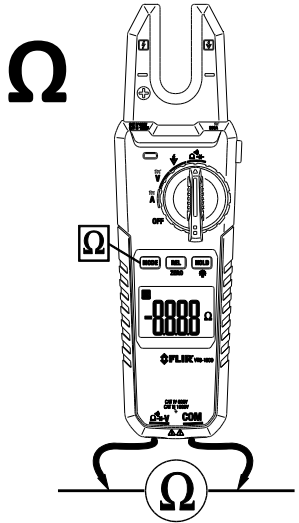
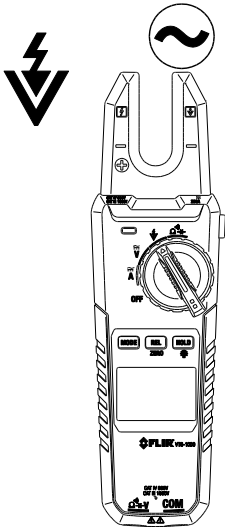



Corporate Headquarters

FLIR Systems, Inc.
2770 SW Parkway Avenue
Wilsonville, OR 97070 USA
Telephone: +1 503-498-3547

Customer Support

Technical Support Website
Technical Support Email
Service and Repair Email
Customer Support Telephone

<http://support.flir.com>
TMSupport@flir.com
Repair@flir.com
+1 855-499-3662 option 3 (toll free)

Publication Identification No.: VT8-600_1000-QS
Release version: AA
Release Date: September 2018
Language: en-US

Copyright © 2018 FLIR Systems, Inc.

All rights reserved including the right of reproduction in whole or in part in any form.

www.flir.com