



I-V400w -- SOLAR I-Vw I-V500w -- SOLAR I-Ve

CE

User manual



Table of contents:

1. SAFETY PRECAUTIONS AND PROCEDURES	3
1.1. Preliminary instructions	3
1.2. During use	4
1.3. After use	4
1.4. Overvoltage categories - Definitions	4
2. GENERAL DESCRIPTION	5
2.1. Introduction	5
2.2. Instrument features	5
3. PREPARATION FOR USE	6
3.1. Initial checks	6
3.2. Instrument power supply	6
3.3. Storage	6
4. DESCRIPTION OF PARTS	7
4.1. Instrument description	7
4.2. Keyboard description	8
4.3. Display description	8
4.4. Initial screen	8
5. MAIN MENU	9
5.1. SET – Instrument settings	9
5.1.1. General	9
5.1.2. Measurement units	10
5.1.3. Date/Time	10
5.1.4. Remote unit/Solarim.	11
5.1.5. Irradiance	12
5.1.6. DC Clamp (SOLAR I-Vw or SOLAR I-Ve)	12
5.2. EFF – SETTINGS FOR TESTING PV SYSTEMS (SOLAR I-Vw or SOLAR I-Ve)	13
5.2.1. Settings for PV systems with single-MPPT inverter - single-phase AC output	13
5.2.1.1. Instrument settings	13
5.2.1.2. PV plant parameters	14
5.2.2. Settings for PV with single/multi MPPT inverter – single/three phase AC output	15
5.2.2.1. Instrument settings	15
5.2.2.2. PV plant parameters	16
5.2.2.3. MPP300 status	17
5.2.3. Selection of the compensation relationship of temperature effects	18
5.3. DB – Module database	19
5.3.1. How to define a new PV module	20
5.3.2. How to modify a PV module	21
5.3.3. How to delete a PV module	21
6. HOW TO OPERATE	22
6.1. Testing PV systems (SOLAR I-Vw or SOLAR I-Ve)	22
6.1.1. Testing of PV systems with single-MPPT inverter - single-phase AC output	23
6.1.2. Test PV systems with single/multi-MPPT inverter – single/three-phase AC output	27
6.2. I-V curve measurement	33
6.2.1. I-V curve measurement by use of instrument	33
6.2.2. I-V curve measurement by use of remote unit SOLAR-02	37
6.2.2.1. I-V curve test by remote unit SOLAR-02 in RF connection	37
6.2.2.2. I-V curve test by remote unit SOLAR-02 in synchro recording	41
6.2.3. Meaning of measurement results	46
6.3. Quick Check on PV modules and strings (IVCK)	47
6.3.1. General information	47
6.3.2. Preliminary settings	48
6.3.3. Fast check IVCK without irradiance measurement	49
6.3.4. Fast check IVCK with irradiance measurement	51
6.3.5. Reset Media	53
6.4. List of display messages	54
7. STORING DATA	55
7.1. Saving test results of PV checks (SOLAR I-Vw or SOLAR I-Ve)	55
7.2. Saving test results of I-V curve test	55

7.3.	Managing the results	56
7.3.1.	Recall data of PV checks at display (SOLAR I-Vw or SOLAR I-Ve)	56
7.3.2.	Recall data of I-V curve tests at display.....	57
7.3.2.1.	View data – Numerical screens.....	58
7.3.2.2.	View data – Graphic screens of I-V curve.....	59
7.3.2.3.	View data – Graphic screens of power.....	60
7.3.3.	Delete data.....	61
8.	CONNECTING THE INSTRUMENT TO A PC.....	62
8.1.	Connecting by optical/USB cable C2006	62
8.2.	Connecting by WiFi	63
9.	MAINTENANCE.....	64
9.1.	General.....	64
9.2.	Battery replacement	64
9.3.	Instrument cleaning.....	64
9.4.	End of life	64
10.	TECHNICAL SPECIFICATIONS.....	65
10.1.	Yield test technical feratures (SOLAR I-Vw, SOLAR I-Ve).....	65
10.2.	I-V test technical features (I-V and IVCK)	67
10.3.	Safety specifications.....	68
10.3.1.	General	68
10.4.	General characteristics.....	69
10.5.	Environment conditions	69
10.6.	Accessories.....	69
11.	APPENDIX	70
11.1.	Testing photovoltaic systems (SOLAR I-Vw, SOLAR I-Ve).....	70
11.2.	Notes on MPPT (Maximum Power Point Tracker)	71
11.3.	Theoretical aspects of the I-V curve measurement.....	72
11.3.1.	Typical errors on I-V curves and troubleshooting	73
12.	SERVICE.....	75
12.1.	Warranty conditions.....	75
12.2.	Service	75

1. SAFETY PRECAUTIONS AND PROCEDURES

The word “instrument” in this manual means generically both the models I-V400w, I-V500w, SOLAR I-Vw or SOLAR I-Ve e SOLAR I-Ve except notation specifically indicated. This instrument has been designed in compliance with directives IEC/EN61010-1 regarding electronic measuring instruments. Before and while measuring, carefully follow the instructions below:

- Do not perform voltage or current measurements in humid environments
- Do not perform measurements near explosive gas or material and fuels or in dusty environments
- Avoid contact with the circuit tested if no measurement is being performed
- Avoid contact with exposed metal parts, test terminals not in use, circuits, etc.
- Do not perform any measurement if instrument anomalies are detected, such as deformations, breaks, leakage of substances, no display reading, etc.
- Only use original HT accessories

In this manual, following symbols are used:



CAUTION: Follow the instructions given in this manual; improper use may damage the instrument, its components or create dangerous situations for the operator



High voltage: risk of electrical shock

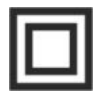

Double insulation



DC voltage or current



AC voltage or current



Ground reference

1.1. PRELIMINARY INSTRUCTIONS



- This instrument has been designed for use in the environmental conditions specified in § 10.5. Do not use in different environmental conditions.
- The instrument may be used for measuring of **VOLTAGE** and **CURRENT** in CAT II 1000V DC or CAT III 300V to ground, maximum voltage 1000V between inputs (I-V400w and SOLAR I-Vw or SOLAR I-Ve) or 1500V (I-V500w and SOLAR I-Ve) Do not use on systems exceeding the limit values specified in § 10.1 and § 10.2
- We recommend to follow the ordinary safety rules aimed at: your protection against dangerous currents, the instrument’s protection against improper use.
- Only the accessories provided with the instrument guarantee compliance with safety standards. They must be in good conditions and must be replaced, if necessary, with identical models.
- Check that batteries are correctly inserted.
- Before connecting the test cables to the circuit being tested, check that the desired function has been selected.

1.2. DURING USE

We recommend to carefully read the following recommendations and instructions:



CAUTION

- Failure to comply with the CAUTIONs and/or instructions may damage the instrument and/or its components or cause dangers to the operator.
- The symbol “” indicates the charge level. When there are five bars, it means that batteries are fully charged; a decrease in the number of bars down to “” indicates that the batteries are almost low. In this case, interrupt tests and replace the batteries according to the indications given in § 9.2. **The instrument is capable of keeping data stored even without batteries.**

1.3. AFTER USE

When measuring operations are completed, turn off the instrument by pressing and holding the ON/OFF key for a few seconds. Should the instrument remain unused for a long time, remove batteries and follow the indications given in § 3.3.

1.4. OVERVOLTAGE CATEGORIES - DEFINITIONS

Standard IEC/EN61010-1 (Safety requirements for electrical equipment for measurement, control and laboratory use, Part 1: General requirements) defines what a measurement category (usually called “overvoltage category”) is. At § 6.7.4: Measuring circuits it quotes:

Circuits are divided into the following measurement categories:

- **Measurement Category IV** is for measurements performed at the source of the low-voltage installation.
Examples are electricity meters and measurements on primary overcurrent protection devices and ripple control units.
- **Measurement Category III** is for measurements performed in the building installation.
Examples are measurements on distribution boards, circuit breakers, wiring, including cables, bus-bars, junction boxes, switches, socket-outlets in the fixed installation, and equipment for industrial use and some other equipment, for example, stationary motors with permanent connection to fixed installation.
- **Measurement Category II** is for measurements performed on circuits directly connected to the low voltage installation.
Examples are measurements on household appliances, portable tools and similar equipment.
- **Measurement Category I** is for measurements performed on circuits not directly connected to MAINS.
Examples are measurements on circuits not derived from MAINS, and specially protected (internal) MAINS-derived circuits. In the latter case, transient stresses are variable; for that reason, the norm requires that the transient withstand capability of the equipment is made known to the user.

2. GENERAL DESCRIPTION

2.1. INTRODUCTION

The instrument was designed to perform complete yield test on **single-phase** (and three-phase if combined with optional accessory MPP300) PV installations with calculations of efficiencies (SOLAR I-Vw or SOLAR I-Ve) and to perform all I-V curve tests on single modules (panels) or complete strings of photovoltaic (PV) plants in order to verify the reference parameters given by the manufacturers.

2.2. INSTRUMENT FEATURES

The instrument can perform the following tests:

Check Single phase PV installations (EFF - SOLAR I-Vw and SOLAR I-Ve)

- DC voltage and current measurements (1000V for SOLAR I-Vw 1500V for SOLAR I-Ve)
- AC TRMS voltage and current measurements
- DC/AC power measurement
- Solar irradiation [W/m^2] measured by use of reference cell connected to unit SOLAR-02
- Module and environ. temp. measurement by means of probe connect to SOLAR-02
- Use of compensation relationships on PDC measurements
- Immediate evaluation of result OK/NO of a test
- Checks with programmable IP from 5s to 60min

Testing single/three-phase PV systems (MPP – SOLAR I-Vw, SOLAR I-Ve + MPP300)

- Measurement of 3 DC voltages and currents
- Measurement of DC string power and total DC power
- Measurement of 3 AC TRMS voltages and currents
- Measurement of total AC power
- Measurement of irradiation [W/m^2] by means of a reference cell connected to SOLAR-02
- Module and environ. temp. measurement by means of probe connect to SOLAR-02
- Application of compensation relationships to DC efficiency.
- Immediate evaluation of result OK/NO of a test
- Parameter recording of a PV system with 5s to 60min programmable IP

I-V Curve measurement

- Voltage, current, power of PV module/string 1000VDC, 15ADC (SOLAR I-Vw, I-V400w)
- I-V/power module/string 1500VDC-10ADC or 1000VDC-15ADC (SOLAR I-Ve, I-V500w)
- Activation of manual or automatic measurement
- PV module/string temperature measurement
- Irradiance measurement [W/m^2] by using reference cell
- Numerical and graphical results of I-V curve with 4-wire method
- Comparison of results with standard conditions (STC) and OK/NO final response
- Internal customizable database for definition up to 30 PV modules
- Annual degradation evaluation of PV modules/strings/fields
- Internal memory for saving test and Optical/USB interface for PC connection

Quick Check (IVCK)

- Fast test of open voltage and short circuit current up to 1000V DC, 15A (SOLAR I-Vw, I-V400w) and up to 1500VDC, 15A (SOLAR I-Ve, I-V500w)
- Activation of manual or automatic measurement
- Immediate evaluation (OK/NO) of test results

The instrument has an innovative electronic function selector to simply set operations with internal parameters, a backlit display, the contrast adjustment and a **HELP** key in order to give a valid help to the operator during the meter's connection to the plants. An enable/disable Auto Power OFF feature is available after about 5 minutes of idleness.

3. PREPARATION FOR USE



3.1. INITIAL CHECKS

Before shipment, the instrument's electronics and mechanics have been carefully checked. All possible precautions have been taken to have the instrument delivered under optimal conditions. However, we recommend to rapidly check the instrument in order to detect possible damage occurred during transport. Should you detect anomalies, please immediately contact the dealer.

It is also recommended to check that the package contains all parts indicated in § 10.6. In case of discrepancies, please contact the dealer. Should it be necessary to return the instrument, please follow the instructions given in § 12.

3.2. INSTRUMENT POWER SUPPLY

The instrument is battery supplied. For battery type and life, see § 10.4.

The symbol “” indicates the charge level. When there are five bars next to the battery symbol, it means that batteries are fully charged; a decrease in the number of bars down to “” indicates that the batteries are almost low. In this case, interrupt tests and replace the batteries according to the indications given in § 9.2.

The instrument is capable of keeping data stored even without batteries.

The instrument is provided with advanced algorithms to maximize the batteries' life.

During instrument operation, a further short pressing of the  key turns on the display's backlighting (if battery voltage level is high enough). In order to save battery efficiency, backlighting automatically turns off after approx. 30 seconds.

A frequent use of back lighting reduces the batteries' life

3.3. STORAGE

In order to guarantee precise measurements, after a long period of the instrument's storage under extreme environmental conditions, wait until it recovers its normal conditions (see § 10.5).

4. DESCRIPTION OF PARTS

4.1. INSTRUMENT DESCRIPTION

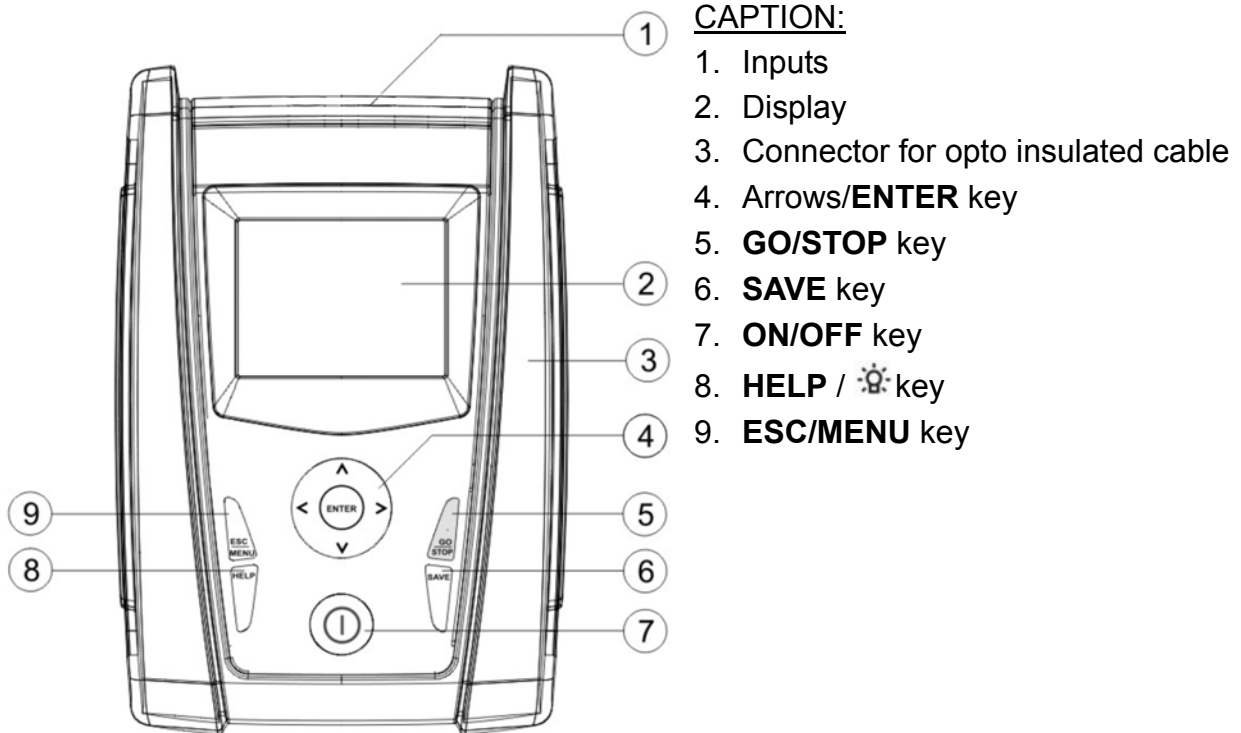

CAPTION:

1. Inputs
2. Display
3. Connector for opto insulated cable
4. Arrows/**ENTER** key
5. **GO/STOP** key
6. **SAVE** key
7. **ON/OFF** key
8. **HELP** / ☀ key
9. **ESC/MENU** key

Fig. 1: Description of the front part of the instrument

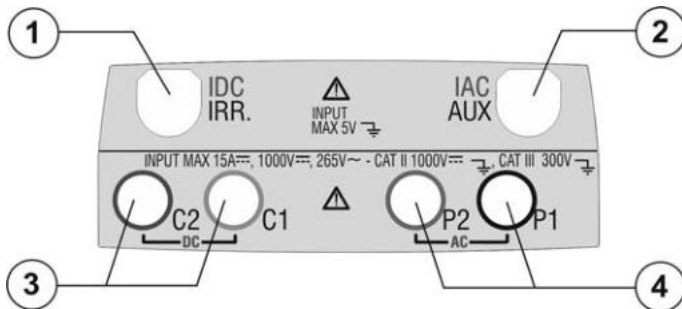

CAPTION:

1. Input for irradiance probe (I-V) / DC transducer clamp (EFF – SOLAR I-Vw, SOLAR I-Ve)
2. Input for auxiliary temperature probe (I-V) / AC transducer clamp (EFF – SOLAR I-Vw, SOLAR I-Ve)
3. C1, C2 inputs for current measurement (I-V) / voltage measurement (EFF – SOLAR I-Vw, SOLAR I-Ve)
4. P1, P2 inputs for voltage measurement (I-V) / AC voltage (EFF – SOLAR I-Vw, SOLAR I-Ve)

Fig. 2: Description of the upper part of the instrument

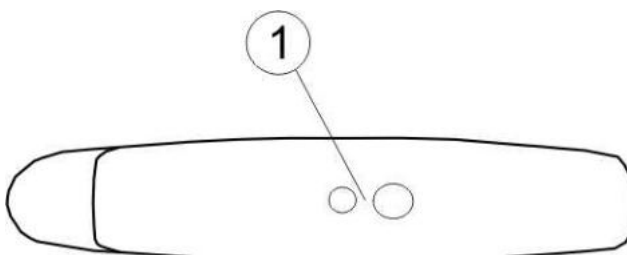

CAPTION:

1. Connector for opto insulated cable connection

Fig. 3: Description of the instrument's side

4.2. KEYBOARD DESCRIPTION

The keyboard includes following keys:



ON/OFF key to switch on/off the instrument



ESC/MENU key to exit the selected menu without confirming and to activate menu management



◀ ▶ ▲ ▼ keys to move the cursor through the different screens in order to select the desired programming parameters

ENTER key to confirm the modifications and the selected programming parameters and to select the function from the menu



GO/STOP key to start measurements



SAVE key to save the measured values



HELP key (long pressure) to display an indicative outline of the connections between the instrument and the system being tested in the function set

☀ key (short pressure) to turn on the display's backlighting

4.3. DISPLAY DESCRIPTION

The display is a graphic module with a resolution of 128 x 128 dots. The display's first line indicates the system date/hour and the battery charge indicator.

In the bottom part the functionality of **ENTER** key and the active mode is displayed

The symbol  indicates the presence of an active radio connection with the selected remote unit (SOLAR-02 or MPP300).

The flashing symbol  indicates that the instrument is currently searching for a radio connection with the selected remote unit (SOLAR-02 or MPP300).

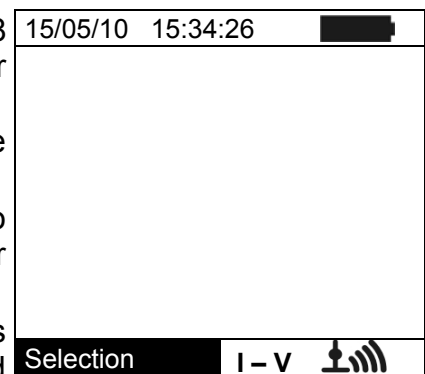

4.4. INITIAL SCREEN

When turning on the instrument, the instrument displays the initial screen for a few seconds. It displays the following:

- The instrument's model
- The manufacturer's name
- Internal presence of modules for RF (Radio Frequency) and WiFi connection
- The serial number (SN:) of the instrument
- The firmware version (FW:) in the instrument's memory
- The date of the last calibration (Calibration date:)

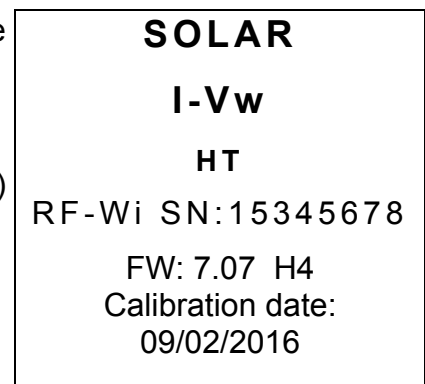

Then, the instrument switches to the last function selected.

5. MAIN MENU

Pressing the **MENU/ESC** key in any allowable condition of the instrument displays the main menu screen, in which the instrument may be set, the saved measures can be displayed and the desired measuring function may be set (item EFF only appears for instrument SOLAR I-Vw or SOLAR I-Ve).

Select by cursor the desired options and confirm by pressing **ENTER**

15/05/10 15:34:26	
I-V	I-V Test
EFF	Yield Test
SET	Settings
DB	Modules
MEM	Data Recall
PC	PC connection
ENTER to select.	
	MENU

5.1. SET – INSTRUMENT SETTINGS

Move the cursor to **SET** by means of the arrow keys (**▲**, **▼**) and confirm with **ENTER**. Subsequently, the displays shows the screen which provides access to the various instrument's settings.

The settings will remain valid also after switching off the instrument

15/05/10 15:34:26	
General	
Meas. Unit	
Date and Time	
Remote Unit/Solarim.	
Irradiance	
DC Clamp	
ENTER to select.	
	SET

5.1.1. General

1. Move the cursor to **General** by means of the arrow keys (**▲**, **▼**) and confirm with **ENTER**
2. The displays shows the screen which allows:
 - Setting the instrument language
 - Setting the enable/disable of auto power off
 - Adjusting the contrast of display
 - Enabling the acoustic signal when pressing a key
 - Setting the enable/disable of WiFi interface inside each section of main menu for using the instrument with the HTAnalysis APP (in the **PC** section the WiFi interface is always on). With WiFi enabled the "📶" symbol is shown in the bottom right side of the display. The enable of WiFi interface means a higher consumption of the batteries
3. By means of the arrow keys (**▲**, **▼**) and select the desired option by means of the arrow keys (**◀**, **▶**)
4. Confirm with **SAVE** and the "Data saved" message is displayed for a while. Press the **ESC/MENU** key to exit without saving and to go back to the previous screen

15/05/10 15:34:26	
Language : ◀ English ▶	
AUTOPOWEROFF:NO	
Contrast:	10
Key Beep:	NO
WiFi:	NO
SAVE to store data	
	SET

5.1.2. Measurement units

This § allows setting the default measurement units of some internal parameters included in the database (DB) for the management of PV modules (§ 5.3)

1. Move the cursor to “**Meas. Unit**” by means of the arrow keys (▲, ▼) and confirm with **ENTER**.
2. The display shows the screen which allows selecting the measurement units of parameters shown by the meter.
3. Press **ESC/MENU** to exit without saving any setting.

15/05/10 15:34:26 	
Parameter	
ENTER to select	
MENU	

4. Move the cursor to “**Parameter**” by means of the arrow keys (▲, ▼) and confirm with **ENTER**.
5. The display shows the screen which allows selecting the measurement units of typical parameters of the modules:
 - Alpha → possible selection: “%/°C” and “mA/°C”
 - Beta → possible selection: “%/°C” and “mV/°C”
 - Gamma → possible selection: “%/°C” and “W/°C”
 - Tolerance → possible selection: “%” and “W”
6. Set the desired units by means of the arrow keys (◀, ▶).
7. Confirm with **SAVE** and the “Saved data” message is displayed for a while. Press **ESC/MENU** key to exit without saving and to go back to the previous screen.

15/05/10 15:34:26 	
Alpha	: ◀ mA/°C ▶
Beta	: mV/°C
Gamma	: W/°C
Tolerance	: %
SAVE to store data	
SET	

5.1.3. Date/Time

1. Move the cursor to “**Date/Time**” by means of the arrow keys (▲, ▼) and confirm with **ENTER**
2. The display shows the screen which allows setting the system date/time both in the **European (EU)** or **USA (US)** format.
3. Set the values by means of the arrow keys (◀, ▶).
4. Confirm with **SAVE** and the “Saved data” message is displayed for a while. Press **ESC/MENU** key to exit without saving and to go back to the previous screen.

15/05/10 15:34:26 	
Year	: ◀ 2009 ▶
Month	: 06
Day	: 15
Hour	: 09
Minute	: 53
Format	: EU
SAVE to store data	
SET	

5.1.4. Remote unit/Solarim.

This section allows selecting the type of remote unit to be used (if available) and setting the values of typical parameters (Sensitivity and Alpha) of the reference irradiance cell supplied with the meter. **The values of these parameters, which are printed on the back label of the cell, depend on the type of PV modules on test.**

1. Move the cursor to **“Remote unit”** by means of the arrow keys (**▲, ▼**) and confirm with **ENTER**
2. The display shows the screen which allows:
 - Select the type of remote unit to be used for testing PV systems (SOLAR I-Vw or SOLAR I-Ve):
 - NO: Remote unit disabled
 - SOLAR: Use of SOLAR-02
 - MPP300: Use of MPP300 (optional)
 - Enable/disable the use of the remote unit SOLAR-02 for I-V measurements (opt. for I-V400w and I-V500w). In case the use of the remote unit has not been enabled, it will be possible to set the sensitivity values (sens.) of the reference cell provided, expressed in “mV/kW*m-2”, and of the Alpha parameter.
3. Set the value by means of the arrow keys (**◀, ▶**)
4. Confirm with **SAVE** and the “Saved data” message is displayed for a while. Press **ESC/MENU** key to exit without saving and to go back to the previous screen

15/05/10 15:34:26	
Remote U EFF	MPP300
Remote U I-V:	: ◀ NO ▶
Sens. :	◀ 31.0 ▶ mV/kW/m ²
Alpha :	0.060 %/°C
SAVE to store data	
SET	



CAUTION

For EFF measurements (testing of PV systems – SOLAR I-Vw or SOLAR I-Ve), disabling the remote unit entails:

- **The impossibility of carrying out Irradiation and Temperature measurements by means of unit SOLAR-02**
- **The impossibility of using the unit MPP300 (if available)**

Consequently, it will be impossible to obtain a result for the test carried out.

5.1.5. Irradiance

1. Move the cursor to “**Irradiance**” by means of the arrow keys (▲, ▼) and confirm with **ENTER**.
2. The display shows the screen with the options: “**Irr min IV**” which allows to set the minimum threshold of measured irradiance expressed in W/m^2 , used by meter as reference during the I-V curve measurements and “**Irr min EFF**” (SOLAR I-Vw or SOLAR I-Ve which allows to set the minimum threshold of measured irradiance expressed in W/m^2 , used by meter as reference during the check PV efficiency measurements
3. Set the value by means of the arrow keys (◀, ▶). The accuracy indicated in this manual is granted under condition indicated in § 10.1 and § 10.2. In I-V curve measurement the value is set within the $0 \div 800 W/m^2$ interval while $400 \div 800 W/m^2$ for the PV check operations (SOLAR I-Vw or SOLAR I-Ve)
4. Confirm with **SAVE** and the “Saved data” message is displayed for a while. Press **ESC/MENU** key to exit without saving and to go back to the previous screen.

15/05/10 15:34:26	
Irr min IV : ◀ 0 ▶ W/m2	
Irr min EFF : ◀ 600 ▶ W/m2	
SAVE to store data	
	SET



CAUTION

The “0 W/m2” setting for parameter “Min Irr IV” allows carrying out I-V measurements without the following conditions being checked:

- Connection of reference cell to input IRR of the instrument
- Unsteady irradiation values
- Number of modules consistent with the measured open circuit voltage

5.1.6. DC Clamp (SOLAR I-Vw or SOLAR I-Ve)

This option allows setting a **possible** correction factor K for the DC clamp, in order to improve current measurement. If present, the correction factor is indicated on the rear label of the clamp itself, indicated as:

K= X.xxx

In case no label is present, set $k = 1.000$

1. Move the cursor to “**DC Clamp**” by means of the arrow keys (▲, ▼) and confirm with **ENTER**
2. The item: “**DC clamp k**” is shown at display to set the corrective factor in a interval within **0.950** and **1.050**. Set the value by means of the arrow keys (◀, ▶)
3. Confirm with **SAVE** and the “Saved data” message is displayed for a while. Press **ESC/MENU** key to exit without saving and to go back to the previous screen

15/05/10 15:34:26	
DC clamp k : ◀ 1.000 ▶	
SAVE to store data	
	SET

5.2. EFF – SETTINGS FOR TESTING PV SYSTEMS (SOLAR I-VW OR SOLAR I-VE)

Further in this manual, the acronym **MPPT** (Multiple Power Point Tracker) shall indicate the characteristic of the DC/AC converter (inverter), capable of maximizing the DC power which can be taken from the photovoltaic field. See § 11.2 for further details.

5.2.1. Settings for PV systems with single-MPPT inverter - single-phase AC output

Check beforehand the settings made in **MENU→SET→Remote Unit** and check that you have selected “**SOLAR**” as setting for parameter “**R. unit**”.

5.2.1.1. Instrument settings

1. Press **MENU** key, move the cursor to “**EFF**” by means of the arrow keys (**▲,▼**) and confirm with **ENTER**. The screen with the values of electrical parameters relative to PV generator is displayed

15/05/10 15:34:26		
Prp	- - -	
Irr	- - -	W/m ²
Pnom	0.000	kW
Tc	- - -	°C
Te	- - -	°C
Pdc	0.0	kW
Vdc	0.000	V
Idc	0.0	A
ndc	- - -	
▼		
GO – Start rec		
Select	EFF	

2. Press **ENTER** key. The options **Set PV plant** and **Set Instrum.** are displayed
3. By means of the arrow keys (**▲,▼**) to select **Set Instrum.** and confirm with **ENTER**. The herewith screen is shown:

15/05/10 15:34:26		
PRp	- - -	
Irr	- - -	W/m ²
Pnom	0.000	kW
Tc	- - -	°C
Te	- - -	°C
Pdc	0.0	kW
Vdc	0.000	V
Idc	0.0	A
ndc	- - -	
Set PV plant		
Set Instrum.		
Select	EFF	

4. By means of the arrow keys (**◀,▶**) the herewith parameters are set:

- IP (integration period) used by meter during yield test recording. The values | **5s, 10s, 30s, 60s, 120s, 300s, 600s, 900s, 1800s, 3600s** are selectable
- The full scale (FS) of DC clamp used on DC current measurement with selectable value within **1A ÷ 3000A**
- The full scale (FS) of AC clamp used on AC current measurement with selectable value within **1A ÷ 3000A**

15/05/10 15:34:26		
IP	: ◀ 5 ▶ s	
FS DC clamp	: 1000 A	
FS AC clamp	: 1000 A	
SAVE to store data		
		EFF

5. Press the **SAVE** key to save the settings made; the message “Data saved” will be displayed for a few seconds. Press the **ESC/MENU** key to exit without saving and go back to the previous screen.

5.2.1.2. PV plant parameters

1. Press **MENU** key, move the cursor onto **EFF** by using the arrow keys (**▲**, **▼**) and confirm with **ENTER**. The display shows the values of the output electrical parameters of the photovoltaic generator (DC side).

15/05/10 15:34:26		
PRp	- - -	
Irr	- - -	W/m ²
Pnom	0.000	kW
Tc	- - -	°C
Te	- - -	°C
Pdc	0.0	kW
Vdc	0.000	V
Idc	0.0	A
ndc	- - -	
▼		
GO - start rec		
Select		EFF

2. Press the **ENTER** key. The instrument shows the following options: “**Set PV plant**” and “**Set Instrum**”.
3. Use the arrow keys (**▲**, **▼**) to select “**Set PV plant**” and confirm with **ENTER**. The instrument shows the following screen:

15/05/10 15:34:26		
Prp	- - -	W/m ²
Irr	- - -	W/m ²
Pnom	0.000	kW
Tc	- - -	°C
Te	- - -	°C
Pdc	0.0	kW
Vdc	0.000	V
Idc	0.0	A
ndc	- - -	
Set PV plant		
Set Instrument		
Select		EFF

4. By means arrow keys (**◀**, **▶**) the herewith parameters are set:

- **Pmax** → maximum nominal power of the PV installation expressed in kW
- **Gamma** → coefficient of variation of power with the temperature, standard parameter of PV module (range: -0.3 ÷ -0.5%/°C typical)
- **Noct** → nominal working temperature of a PV cell, standard parameter of PV module (range: 42 ÷ 48°C typical)
- **Te, Tc** → set of default values of environmental temperature and PV module temperature. These values are considered by the meter only without the auxiliary probe connected to emote unit SOLAR-02
- **Corr. Type** → set the corrective term Ptpv for DC efficiency calculation and for maximum DC efficiency visualization (see § 5.2.3)

15/05/10 15:34:26		
Pmax : ◀ 3.500 ▶ kW		
Gamma	:	0.45 %/°C
Noct	:	45 °C
Te	:	40 °C
Tc	:	45 °C
Corr. Type	:	T. Env
SAVE to store data		
		EFF

5.2.2. Settings for PV with single/multi MPPT inverter – single/three phase AC output

See § 11.2 for further details about the meaning of MPPT. This mode requires using the remote unit **MPP300** (optional). Check beforehand the settings made in **MENU→SET→Remote Unit** and check that you have selected “**MPP300**” as setting for parameter “**R. unit**”.

5.2.2.1. Instrument settings

1. Press the **MENU** key, position the cursor onto **EFF** by using the arrow keys (**▲**, **▼**) and confirm with **ENTER**. The display shows the screen here to the side, which contains the global parameters of the system.

15/05/10 15:34:26		
PRp	- - -	
Irr	- - -	W/m ²
Pnom	150.0	kW
Tc	- - -	°C
Te	- - -	°C
Pdc	- - -	kW
Pac	- - -	kW
ndc	- - -	
nac	- - -	
▼		
GO - start Rec		
Select		MPP

2. Press the **ENTER** key. The instrument shows the following options: **MPP300 status**, **System Par.** and **Instrument settings**.

3. Use the arrow keys (**▲**, **▼**) to select “**Instrument settings**” and confirm with **ENTER**. The instrument shows the following screen:

15/05/10 15:34:26		
PRp	- - -	
Irr	- - -	W/m ²
Pnom	150.0	kW
Tc	- - -	°C
Te	- - -	°C
Pdc	- - -	kW
Pac	- - -	kW
ndc	- - -	
nac	- - -	
MPP300 Status		
Set PV plant		
Set Instrum.		
Select		MPP

4. By using the arrow keys (**◀**, **▶**) it is possible to set:
 - the integration period (IP) which can be used by the instrument when testing the parameters of a PV system. The following values can be selected: **5s**, **10s**, **30s**, **60s**, **120s**, **300s**, **600s**, **900s**, **1800s**, **3600s**
 - The FS of the DC clamp used for measuring DC current with value selectable between **1A ÷ 3000A**
 - The FS of the AC clamp used for measuring AC current with value selectable between **1A ÷ 3000A**
 - The type of AC clamp used: **STD** (standard) or **FLEX** (flexible clamp)
 - The number of DC inputs to be used for measuring: **1**, **1+2**, **1+2+3**
 - The type of AC electrical system: **SINGLE**, **4 wires**

15/05/10 15:34:26		
IP	: ◀ 5 ▶ s	
FS DC clamp:	1000 A	
FS AC clamp:	1000 A	
Clamp Type:	STD	
Dc inputs	1+2+3	
Ac sytem	3phase	
SAVE to store data		
		MPP

5. Press the **SAVE** key to save the settings made; the message “Data saved” will be displayed for a few seconds. Press the **ESC/MENU** key to exit without saving and go back to the previous screen.

5.2.2.2. PV plant parameters

1. Press **MENU** key, position the cursor onto **EFF** by using the arrow keys (**▲**, **▼**) and confirm with **ENTER**. The display shows the screen here to the side, which contains the global parameters of the system.

15/05/10 15:34:26		
PRp	- - -	
Irr	- - -	W/m ²
Pnom	150.0	kW
Tc	- - -	°C
Te	- - -	°C
Pdc	- - -	kW
Pac	- - -	kW
ndc	- - -	
nac	- - -	
▼		
GO – start rec.		
Select		MPP

2. Press the **ENTER** key. The instrument shows the following options: **MPP300 status**, **Set PV plant.** and **Set Instrum.**

3. Use the arrow keys (**▲**, **▼**) to select “**Set PV plant**” and confirm with **ENTER**. The instrument shows the following screen:

15/05/10 15:34:26		
PRp	- - -	
Irr	- - -	W/m ²
Pnom	0.000	kW
Tc	- - -	°C
Te	- - -	°C
Pdc	0.0	kW
Vdc	0.000	V
Idc	0.0	A
ndc	- - -	
MPP300 status		
Set PV plant		
Set instrum.		
Select		MPP

4. By using the arrow keys (**◀**, **▶**) it is possible to set:

- **Pmax** → maximum rated power of PV installation expressed in kW
- **Range** → coefficient of power variation with temperature, characteristic parameter of PV modules (typically in range: -0.3 ÷ -0.5%/C)
- **Noct** → rated operating temperature of the cell, characteristic parameter of PV modules (typically in range: 42 ÷ 48°C)
- **Te, Tc** → setting of default values of environmental and PV module temperatures. These values are taken into consideration by the instrument only when probe is not connected to unit SOLAR-02
- **Corr. Type** → Setting of the compensation relationship on the calculation of Pdc power and the maximization of DC performance (see § 5.2.3)

15/05/10 15:34:26		
Pmax	: ◀ 3.500 ▶ kW	
Gamma	: 0.45 %/°C	
Noct	: 45 °C	
Te	: 40 °C	
Tc	: 45 °C	
Corr.Type.	: T. Env	
SAVE to store data		
		MPP

5.2.2.3. MPP300 status

If SOLAR I-Vw or SOLAR I-Ve is near MPP300, the general parameters of MPP300 may be displayed.

1. Position the cursor onto **EFF** by using the arrow keys (**▲**, **▼**) and confirm with **ENTER**. The display shows the screen here to the side, which contains the global parameters of the system.

15/05/10 15:34:26		
PRp	- - -	
Irr	- - -	W/m ²
Pnom	150.0	kW
Tc	- - -	°C
Te	- - -	°C
Pdc	- - -	kW
Pac	- - -	kW
ndc	- - -	
nac	- - -	
▼		
GO - start rec.		
Select		MPP 

2. Press the **ENTER** key. The instrument shows the following options: **MPP300 status**, **Set PV plant** and **Set Instrum.**
3. Use the arrow keys (**▲**, **▼**) to select "**MPP300 status**" and confirm with **ENTER**. The instrument shows the screen here to the side, which indicates the main general parameters of the instrument.

15/05/10 15:34:26	
Power supply	P.Sup.
Battery	In use
Charge	99%
SOLAR-02	SI
detected	
Version	1.01
SN 11010030	
MPP300 status	
Set PV plant	
Set instrum.	
Select	MENU 

5.2.3. Selection of the compensation relationship of temperature effects

This option allows selecting the relationship to be used to correct the measurements performed according to the modules' temperature. The following correction modes are available:

- T.mod.: Correction factor Rfv2 related to PV module Temp. (Italian guideline CEI-82-25)
- T.env.: Correction factor Rfv2 related to environment Temp. (Italian guideline CEI-82-25)
- ndc: PRp (Performance ratio for active power) corrected by PV module Temp.



CAUTION

If it's performed a test according to Italian guideline it is recommended to select "T.env." correction

Corr. Type	Temperature (Tcel)	PRp calculation	Ref.
T.mod.	$T_{cel} = T_{module_Meas}$	$Rfv2 = \begin{cases} 1 & \text{(if } T_{cel} \leq 40^{\circ}\text{C)} \\ 1 - (T_{cel} - 40) \times \frac{ \gamma }{100} & \text{(if } T_{cel} > 40^{\circ}\text{C)} \end{cases}$ $\rightarrow PRp = \frac{P_{ca}}{\left[Rfv2 \times \frac{G_p}{G_{STC}} \times P_n \right]}$	CEI 82-25
T.amb.	$T_{cel} = \left(T_{amb} + (NOCT - 20) \times \frac{Irr}{800} \right)$		
η_{dc}	$T_{cel} = T_{module_Meas}$	$PRp = \frac{G_{STC}}{G_p} \times \left[1 + \frac{ \gamma }{100} \times (T_{cel} - 25) \right] \times \frac{P_{ca}}{P_n}$	---

where:

Symbol	Description	Meas. unit
G_p	Irradiance on PV module surface	$[\text{W/m}^2]$
G_{STC}	Standard Irradiance = 1000	$[\text{W/m}^2]$
P_n	Nominal Power = sum of all power module (Pmax) included in the part of PV plant under test	$[\text{kW}]$
P_{ca}	AC Active Power measured	$[\text{kW}]$
$Rfv2$	Thermal Coefficient factor	
$ \gamma $	Absolute value of Pmax thermal coefficient	$[\%/^{\circ}\text{C}]$
NOCT	Normal Operating Cell Temperature (@ 800W/m ² , 20°C, AM=1.5, vel. Aria =1m/s).	$[\%/^{\circ}\text{C}]$

For further details see § 11.1

5.3. DB – MODULE DATABASE

The meter allows defining **up to 30 different PV modules**, further to a DEFAULT situation (not editable and not erasable) which can be used as reference case when no piece of information about the module under test is available.

The parameters which can be set, **with reference to 1 module**, are described below in Table 1 together with their range, resolution and validity condition.

Symbol	Description	Range	Resolution	Condition
Nms	Number of modules for string	1 ÷ 50	1	
Pmax	Maximum nominal power of module	50 ÷ 4800W	1W	$\left \frac{P_{\max} - V_{mpp} \cdot I_{mpp}}{P_{\max}} \right \leq 0.01$
Voc	Open voltage	15.00 ÷ 99.99V 100.0 ÷ 320.0V	0.01V 0.1V	Voc ≥ Vmpp
Vmpp	Voltage on point of maximum power	15.00 ÷ 99.99V 100.0 ÷ 320.0V	0.01V 0.1V	Voc ≥ Vmpp
Isc	Short circuit current	0.5 ÷ 15.00A	0.01A	Isc ≥ Impp
Impp	Current on point of maximum power	0.5 ÷ 15.00A	0.01A	Isc ≥ Impp
Toll -	Negative tolerance for Pmax provided by the module manufacturer	0% ÷ 25.0% 0 ÷ 99W	0.1% 1	100*Tol-/Pnom < 25
Toll +	Positive tolerance for Pmax provided by the module manufacturer	0 ÷ 25% 0 ÷ 99W	0.1% 1	100*Tol+/Pnom < 25
Alpha	Isc temperature coefficient	-0.100 ÷ 0.100%/°C -15.00 ÷ 15.00mA/°C	0.001%/°C 0.01mA/°C	100*Alpha / Isc ≤ 0.1
Beta	Voc temperature coefficient	-0.99 ÷ -0.01%/°C -0.999 ÷ -0.001V/°C	0.01%/°C 0.001V/°C	100*Beta/Voc ≤ 0.999
Gamma	Pmax temperature coefficient	-0.99 ÷ -0.01%/°C	0.01%/°C	
NOCT	Nominal working temperature of cell	0 ÷ 100°C	1°C	
Tech.	Effects due to PV technology	STD (standard) CAP (capacitive eff.) HIT (hybrid techn.)		
Degr	Percentage of annual performance degradation	0.0 ÷ 25.0%/yr	0.1%/yr	

Table 1: Typical parameters of PV modules

CAUTION



- The “**Tech**” item is referred to the choose of the technology of the module on test. Select the “STD” option for test on “STANDARD” PV modules, “CAP” option for test on higher capacitive effects PV modules or HIT (modules with HIT/HIP hybrid technology)
- A wrong choose of the type of technology can lead to a negative outcome of the final test
- The “**Degr**” item is referred to the power performance degradation of a PV module/strings/field expressed in annual percentage (maximum limit set = 25%)

5.3.1. How to define a new PV module

- Move the cursor to “**DB**” by means of the arrow keys (▲, ▼) and confirm with **ENTER**. The display shows the screen with:
 - The type of selected module
 - The parameter associated to the module (see Table 1)
- Select the “**DEFAULT**” module by means of the arrow keys (◀, ▶) and confirm with **ENTER**.

15/05/10 15:34:26	
Type : ◀ DEFAULT ▶	
▲	
P max	= 185 W
V oc	= 44.5 V
V mpp	= 37.5 V
I sc	= 5.40 A
I mpp	= 4.95 A
T oll-	= 0 %
▼	
Select	DB

- Press **ENTER**, select the “**New**” command and confirm again with **ENTER**. Use the arrow keys (▲, ▼) to scroll all internal parameters.

15/05/10 15:34:26	
Type : ◀ DEFAULT ▶	
▲	
P max	= 185 W
V oc	= 44.5 V
V mpp	= 37.5 V
I sc	= 5.40 A
I mpp	= 4.95 A
T oll-	= 0 %
▼	
New	
Select	DB

- By using the internal virtual keyboard it is possible to define the name of the module (ex: SUNPOWER 210) by means the arrow keys (▲, ▼, ◀, ▶). Press **ENTER** to digit the characters of the desired name.
- Press the **SAVE** key to save the inserted name of the module as defined or **ESC/MENU** key to exit without saving.

15/05/10 15:34:26	
Type :	
▲	
P max	= 185 W
V oc	= 44.5 V
KEYBOARD	
SUNPOWER 210	
A B C D E F G H I J K L M N O P	
Q R S T U V W X Y Z - + 0 1 2 3	
4 5 6 7 8 9 SPACE DEL	

- Digit the value of each parameter of the defined module (see Table 1) based on the manufacturer’s data sheet. Move the cursor to the row of the parameter by means of the arrow keys (▲, ▼) and set the value by means of the arrow keys (◀, ▶). Press and hold (◀, ▶) for a quick setting of values.
- Confirm with **SAVE** and the “Saved data” message is displayed for a while. Press **ESC/MENU** key to exit without saving and to go back to the previous screen.

15/05/10 15:34:26	
Type : SUNPOWER 210	
▲	
P max	= ◀ 0 ▶ W
V oc	= 0.0 V
V mpp	= 0.0 V
I sc	= 0.00 A
I mpp	= 0.00 A
T oll-	= 0 %
▼	
	DB



CAUTION

- If the value of any parameter is unknown press and hold the **HELP** key for some seconds to set the default values
- After pressing the **SAVE** key, the meter checks all the conditions shown in Table 1 and, if one or more of these conditions do not occur, some error messages are shown by the display (§ 6.5) and the meter does not save the configuration before any error is solved. Solve the error condition before saving.

5.3.2. How to modify a PV module

1. Select the PV module to be modified from the internal database by means of arrow keys (◀,▶).
2. Press the **ENTER** key and select the “**Modify**” command by means the arrow key (▼).
3. Confirm the selection with **ENTER**.

15/05/10	15:34:26	█
Type: ◀ SUNPOWER210 ▶		
▲		
Pmax	=	210 W
Voc	=	47.70 V
Vmpp	=	40.00 V
Isc	=	5.75 A
New		
Modify		
Delete		
Del. All		
Select	DB	

4. By using the internal virtual keyboard it is possible to define a different name of the module by means of arrow keys (▲,▼,◀,▶). Press **ENTER** to digit any character of the desired name.
5. Press the **SAVE** key to save the new name of the module as defined or to access the new setting of parameters.

15/05/10	15:34:26	█													
Type: ◀ SUNPOWER210 ▶															
▲															
Pmax	=	185 W													
Voc	=	44.5 V													
KEYBOARD															
SUNPOWER 210															
A	B	C	D	E	F	G	H	I	J	K	L	M	N	O	P
Q	R	S	T	U	V	W	X	Y	Z	-	+	0	1	2	3
4	5	6	7	8	9	SPACE	DEL								
SAVE/ESC															

6. Select the desired parameters to be modified by means of arrow keys (▲,▼) and change values by means of arrow keys (◀,▶). Press and hold the (◀,▶) for a quick setting of values. If the value of any parameter is unknown, press and hold the **HELP** key for some seconds to set the default values.
7. Confirm with **SAVE** and the “Saved data” message is displayed for a while. Press **ESC/MENU** key to exit without saving and to go back to the previous screen.

15/05/10	15:34:26	█
Type : SUNPOWER 210		
▲		
Pmax	=	◀ 210 ▶ W
Voc	=	47.70 V
Vmpp	=	40.00 V
Isc	=	5.75 A
Imp	=	5.25 A
Toll-	=	5 %
▼		
DB		

5.3.3. How to delete a PV module

1. Select the PV module to be deleted from the internal database by means of arrow keys (◀,▶).
2. Press the **ENTER** key and select “**Delete**” command by means of arrow key (▼) to delete the selected module.
3. Press the **ENTER** key and select “**Del. All**” command by means of arrow key (▼) to delete all modules in the database (except for “DEFAULT”).
4. Confirm the selection with **ENTER** or press **ESC/MENU** to exit

15/05/10	15:34:26	█
Type: ◀ SUNPOWER210 ▶		
▲		
Pmax	=	210 W
Voc	=	47.70 V
Vmpp	=	40.00 V
Isc	=	5.75 A
New		
Modify		
Delete		
Del. All		
Select	DB	



CAUTION

It is not possible to modify or delete the “DEFAULT” PV module which is the standard reference factory module.

6. HOW TO OPERATE

6.1. TESTING PV SYSTEMS (SOLAR I-VW OR SOLAR I-VE)

For the sake of simplicity, further in this manual, the word “string” will be used, although often the term “photovoltaic field” would be more correct. From the point of view of the instrument, the management of a single string or of more parallel strings (photovoltaic field) is identical. Furthermore, the acronym **MPPT** (Multiple Power Point Tracker) shall indicate the characteristic of the DC/AC converter (inverter), capable of maximizing the DC power which can be taken from the photovoltaic field (see the § 11.2 for further details), the acronym PRp shall indicated the Performance ratio (evaluated on active powers).



CAUTION

- **For the evaluation of the PRP only, the measurement of the DC (voltage and current) is not strictly necessary**
- **Conversely it is necessary if you want to evaluate the performance of the photovoltaic section (ndc) and DC / AC conversion (nac)**

Symbol	Description	Unit
PRp	Performance Ratio (calculated through Active power)	
Irr	Irradiance	W/m ²
Pnom	Total Nominal power of the PV section under test.	kW
Tc	Module Temperature	°C
Te	Environment Temperature	°C
Pdc, Pdcx	Total DC power measured, DC power of PV field x (x=1,2,3)	kW
Pac, Pacx	Total AC power measured, AC power of phase x (x=1,2,3,)	kW
ndc	DC efficiency	
nac	AC efficiency	
Vdc, Vdcx	DC Voltage, DC voltage of PV field x (x=1,2,3)	V
Idc, Idcx	DC current, DC current of PV field x (x=1,2,3)	A
Vac, Vacx	AC Voltage, AC voltage of PV field x (x=1,2,3)	V
Iac, Iacx	AC current, AC current of PV field x (x=1,2,3)	A

Symbols description

6.1.1. Testing of PV systems with single-MPPT inverter - single-phase AC output

The SOLAR I-Vw or SOLAR I-Ve meter (master) can perform check tests of efficiencies on single phase PV installations by using the irradiance and temperature probes which are connected to the remote unit SOLAR-02. This remote unit communicates with the master unit (for the synchronization and download data operations) through a wireless radio-frequency (RF) which is active with a maximum distance of about **1m** between units.



CAUTION

- The maximum voltage between C1, and C2 inputs is 1000VDC (for SOLAR I-Vw) or 1500VDC (for SOLAR I-Ve) and between P1 and P2 inputs is 265V AC rms. Do not measure voltages exceeding the limits prescribed by this manual. Should you exceed the voltage limits you could damage the instrument and/or its components or endanger your safety
- In order to guarantee the operator's safety, while making the connections, disable the system being measured by means of the switches/breakers upstream and downstream of the DC/AC converter (inverter).

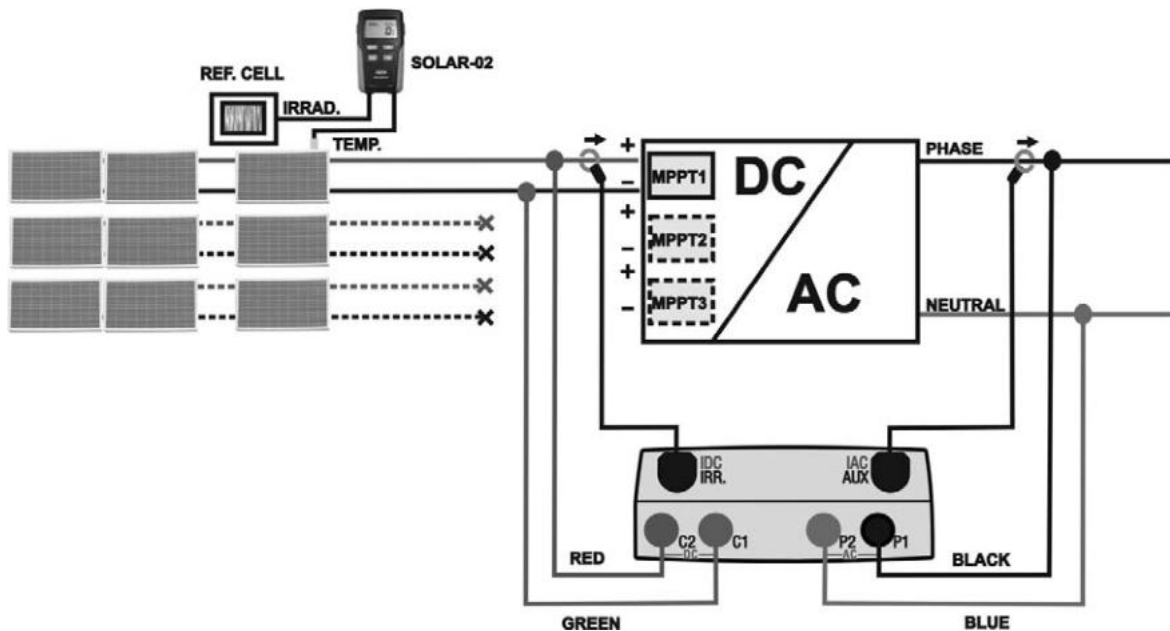



Fig. 4: Connection of meter for check on single phase PV installation

1. Check and, if necessary, set the sensitivity of the reference cell on SOLAR-02 consistently with the type of PV modules which will be measured (please refer to the User Manual of SOLAR-02)
2. We recommend making a preliminary evaluation of the value of irradiation on the surface of the PV modules being tested by means of unit SOLAR-02 (operating independently) and the reference cell
3. Switch on SOLAR I-Vw or SOLAR I-Ve. Check and if necessary modify the basic settings of meter relative to the minimum irradiance threshold, the FS of DC and AC transducer clamps, the IP and the parameters of the PV installation on test (see § 5.1.1, §5.1.5 and §5.2)

4. In order to guarantee the operator's safety, disable the system being measured by means of the switches/breakers upstream and downstream of the DC/AC converter (inverter)
5. In case of inverters provided with more than one power tracker (MPPT), **only leave the string corresponding to the first MPPT connected**, as shown in Fig. 4. Then, it will be necessary to repeat the operations described below by only leaving the string corresponding to the second MPPT connected, then to the third, etc.
6. Bring SOLAR I-Vw or SOLAR I-Ve and SOLAR-02 nearer (maximum distance of 1m between them). **All instruments must be switched on** (see the User Manual of SOLAR-2 for further details)
7. On SOLAR I-Vw or SOLAR I-Ve, press the **MENU** key, select the function **EFF** and press **ENTER**; wait for the two units to start communicating with each other. This condition is highlighted by the contemporary presence of the following indicators:
 - Symbol  steady (not flashing) on the display of SOLAR I-Vw or SOLAR I-Ve
 - Symbol  steady (not flashing) on the display of SOLAR-02
8. Connect the **C2** and **C1** inputs respectively to the positive and negative polarity of the output string. Connect the **P1** and **P2** inputs to the phase and neutral conductors respecting the colors as shown in Fig. 4
9. Connect the output connector of the DC clamp to the **IDC1** input.

**CAUTION****BEFORE CONNECTING THE DC CLAMPS TO THE CONDUCTORS**

Switch on the clamp, check the LED indicating the status of the clamp's internal batteries (if present), select the correct range, press the **ZERO** key on the DC clamp and check on the display of SOLAR I-Vw or SOLAR I-Ve, the actual zeroing of the corresponding I_{dc} value (values up to 0.02A are acceptable).

10. Connect the DC current clamp to the positive string output conductor **by respecting the direction of the arrow** on the clamp itself as indicated in Fig. 4. Position the DC clamp in point so far from the inverter and avoid that the jaws stay close to the negative conductor
11. Connect the AC current clamp to the Phase L1 conductor **by respecting the direction of the arrow** on the clamp itself as indicated in Fig. 4. Position the AC clamp as far as possible from the inverter and avoid that the jaws stay close to the neutral conductor. Connect the output of the clamp to the **IAC** input of the instrument
12. Power on the system on test

13. The display shows the first screen containing the values of the electrical parameters on the DC side of the inverter.

15/05/10 15:34:26		
PRp	- - -	
Irr	- - -	W/m ²
Pnom	3.500	kW
Tc	45	°C
Te	30	°C
Pdc	3.125	kW
Vdc	389	V
Idc	8.01	A
ndc	- - -	
▼		
GO – start rec.		
Select		EFF

14. By means of arrow key ▼ to access to the second screen with the values of electrical parameters of the AC side of inverter. **Before to start the recording:**

- Verify the symbol “” blinking at display which means the search by the meter of RF connection with the remote unit SOLAR-02
- Verify that the Pac active power should be a positive value. In the opposite case open the AC clamp and rotate of 180 degree on the phase conductor
- Verify that the AC efficiency $\eta_{ac} = P_{ac} / P_{dc}$ should be a consistent value (e.g.: a situation of $\eta_{ac} > 1$ is not physically possible)

15/05/10 15:34:26		
▲		
Pdc	3.125	kW
Vdc	389	V
Idc	8.01	A
ndc	- - -	°C
Pac	3.012	kW
Vac	231	V
Iac	13.03	A
nac	0.96	
GO – start rec		
Select		EFF

15. With remote unit always close to the main unit press **GO/STOP** key to start the recording. The “**Rec. Start waiting...**” message is shown at display of main unit and the “**HOLD**” message is shown at display of SOLAR-02 more than the indication of residual time for “00” instance

15/05/10 15:34:26		
▲		
Pdc	3.125	kW
Vdc	389	V
Idc	8.01	A
ndc	- - -	°C
Pac	3.012	kW
Vac	231	V
Iac	13.03	A
nac	0.96	
Rec. Start waiting...		
Select		EFF

16. When the “00” instant after the press of **GO/STOP** key is reached, the recording starts and the units are correctly synchronized. In these conditions the message “**Rec running...**” is displayed on the main unit and the “**Recording...**” message is displayed on the SOLAR-02

15/05/10 15:35:00		
▲		
Pdc	3.125	kW
Vdc	389	V
Idc	8.01	A
ndc	- - -	°C
Pac	3.012	kW
Vac	231	V
Iac	13.03	A
nac	0.96	
Rec. Running...		
Select		EFF

17. At any time it will be possible to analyze the current recording status by pressing the **MENU** key. The following information will be shown:

- starting date and time of recording
- the value set for the integration period
- the number of periods elapsed from the beginning of the recording
- the remaining memory capacity for recording

Press the **ESC** key to exit the screen

15/05/10 15:35:00	
Start	14/02/00 17:18:00
Period:	5s
IP Number	61
Rec. Time	0d 1h
Rec. running	
Select	MPP

18. Now it is possible to bring the unit SOLAR-02 near the PV strings to measure irradiation and temperature by means of the relevant probes. When the distance between unit SOLAR-02 and SOLAR I-Vw or SOLAR I-Ve does not allow the RF connection, on the display of SOLAR-02, the symbol “” flashes for approx. 30s and then disappears, while SOLAR I-Vw or SOLAR I-Ve continues searching for the connection for approx. 1 minute.

19. Position the reference cell onto the surface of the PV modules. Please refer to the relevant User Manual for a correct assembly.

20. Put the temperature sensor in contact with the rear side of the module and fasten it with some tape; prevent touching it with your fingers (as this could alter the measure).

21. Wait some seconds in order to permit a stable measure by probes and then connect the irradiation and temperature probes respectively to the inputs **PYRA/CELL** and **TEMP** of the SOLAR-02 unit.

22. Wait for “**READY**” message displayed on SOLAR-02. This event indicates that the instrument has detected some data with solar irradiation > minimum limit threshold (see § 5.1.5)

23. **Wait at least 1 minute in order to recording more valid samples**

24. Disconnect the irradiation and temperature probes from unit SOLAR-02 and bring the unit near SOLAR I-Vw or SOLAR I-Ve (max distance 1m).

25. The main unit SOLAR I-Vw or SOLAR I-Ve must be in **EFF** mode. If there is no flashing symbol “”, press key to activate the RF connection search again.

26. Press the key on SOLAR-02 to active the RF connection. On the main unit the message “RF connection active” is displayed

27. To stop testing, press the **GO/STOP** key on instrument SOLAR I-Vw or SOLAR I-Ve and confirm with **ENTER** that you want to stop recording.

28. The display of SOLAR I-Vw or SOLAR I-Ve will show the message “**DOWNLOAD**” to indicate that the data will be transferred to the main unit during its various phases.

29. After the automatic data transfer phase, the instrument:

15/05/10 15:35:00		
▲		
Irr	971	W/m ²
P _{nom}	3.500	kW
T _c	45.1	°C
T _e	30.5	°C
P _{dc}	3.125	kW
P _{ac}	2.960	kW
n _{dc}	0.86	
n _{ac}	0.95	
Analysis Result		
Select	EFF	

➤ Do not show any results if do not exist on the PV installation a “**stable irradiance**” condition more than the minimum irradiance threshold.

➤ Display the best performance values if during the recording, the Irradiance values reached the “**stable**” condition and its values were higher than the minimum irradiance threshold.

30. Press **SAVE** to save the results (see § 7.1) or **ESC** to exit the screen of the results and go back to the initial screen

6.1.2. Test PV systems with single/multi-MPPT inverter – single/three-phase AC output

The instrument SOLAR I-Vw or SOLAR I-Ve, used together with remote units SOLAR-02 and MPP300 (optional), allows testing PV systems characterized by 1 or more strings (with the same direction and inclination) and single-phase or three-phase output.

The remote unit MPP300 is capable of communicating with SOLAR I-Vw or SOLAR I-Ve (to manage synchronization and data download) and with the remote unit SOLAR-02 (for recording irradiation and temperature values) via a wireless radiofrequency (RF) connection, which is active up to a maximum distance of **1m** between the units.

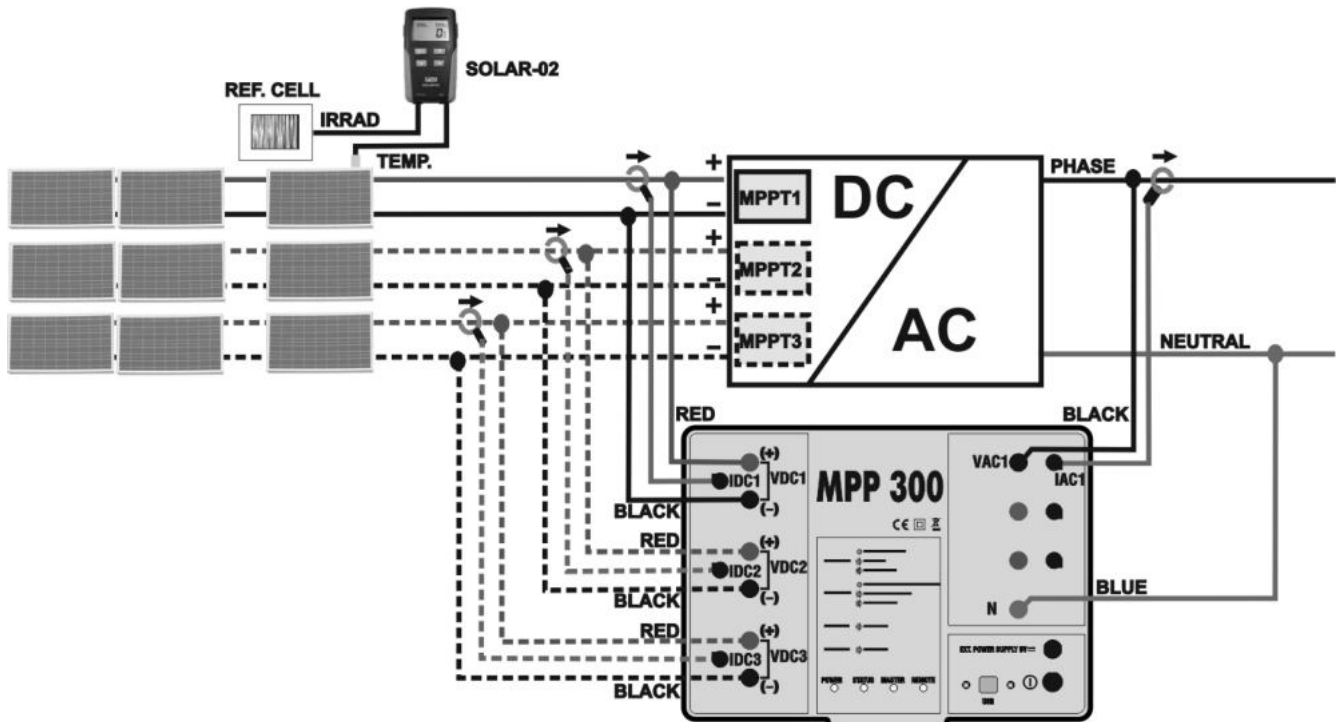

Fig. 5: Connection of MPP300 for testing a single-phase PV system

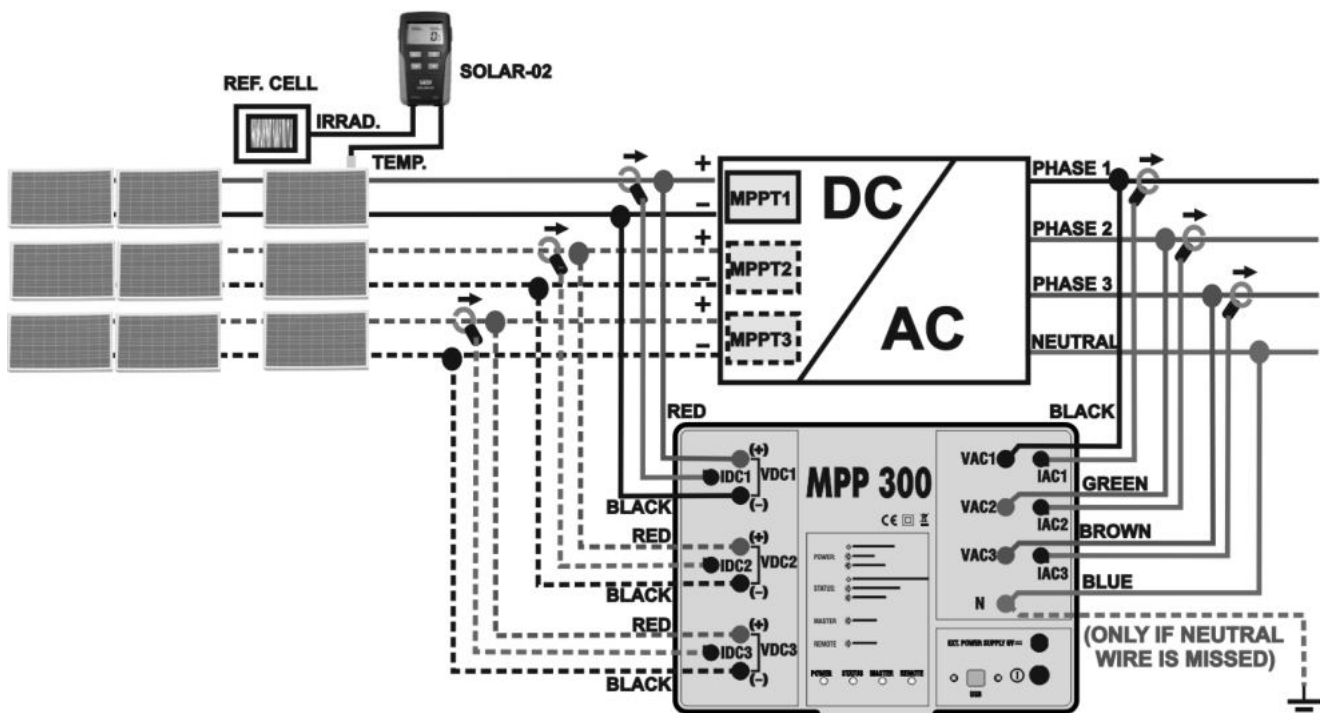



Fig. 6: Connection of MPP300 for testing a three-phase PV system

CAUTION



- When SOLAR I-Vw or SOLAR I-Ve is set in order to use MPP300 as a remote unit, ALL connections relevant to electrical quantities (voltages and currents) must be carried out on unit **MPP300**. SOLAR I-Vw or SOLAR I-Ve must have **no voltage nor current** connected to its inputs.
- The maximum voltage for the inputs of **MPP300** is **1000VDC** between inputs VDC1, VDC2, VDC3 and **600VAC** between inputs VAC1, VAC2, VAC3. Do not measure voltages exceeding the limits given in this manual. Exceeding these limits could result in electrical shocks to the user and damage to the instrument.
- In order to guarantee the operator's safety, while making the connections, disable the system being measured by means of the switches/breakers upstream and downstream of the DC/AC converter (inverter).

1. Check and, if necessary, set the sensitivity of the reference cell on SOLAR-02 consistently with the type of PV modules which will be measured (please refer to the User Manual of SOLAR-02).
2. We recommend making a preliminary evaluation of the value of irradiation on the surface of the PV modules being tested by means of unit SOLAR-02 (operating independently) and the reference cell
3. Switch on SOLAR I-Vw or SOLAR I-Ve, check and, if necessary, change the settings relevant to the type of remote unit, to the minimum irradiation threshold, to the full scale of the AC and DC clamps, to the integration period and to the parameters of the system being measured (see § 5.1.4, § 5.1.5, § 5.1.6, § 5.2.2).
4. In order to guarantee the operator's safety, disable the system being measured by means of the switches/breakers upstream and downstream of the DC/AC converter (inverter).
5. Bring SOLAR I-Vw or SOLAR I-Ve, SOLAR-02 and unit MPP300 nearer (maximum distance of 1m between them). **All instruments must be switched on** (see the User Manuals of SOLAR-2 and MPP300 for further details).
6. On SOLAR I-Vw or SOLAR I-Ve, press the **MENU** key, select the function **EFF** and press **ENTER**; wait for the three units to start communicating with each other. This condition is highlighted by the contemporary presence of the following indicators:
 - Symbol  steady (not flashing) on the display of SOLAR I-Vw or SOLAR I-Ve
 - Symbol  steady (not flashing) on the display of SOLAR-02
 - MASTER and REMOTE LEDs flashing green on unit MPP300
7. Connect the **VDC1(+)** and **VDC1(-)** inputs of unit **MPP300** to the output terminals of the string, respecting the polarities and the colours indicated in Fig. 5 or Fig. 6
8. Repeat the operation described in the step above for other possible DC power trackers to be monitored by using the **VDC2** and **VDC3** inputs according to the number of DC inputs set (see § 5.2.1.1).

9. Connect the output connector of the DC clamp to the **IDC1** input of unit MPP300.



CAUTION

BEFORE CONNECTING THE DC CLAMPS TO THE CONDUCTORS
 Switch on the clamp, check the LED indicating the status of the clamp's internal batteries (if present), select the correct range, press the ZERO key on the DC clamp and check on the display of SOLAR I-Vw or SOLAR I-Ve the actual zeroing of the corresponding Idc value (values up to 0.02A are acceptable).

10. Insert the DC current clamp onto the positive output conductor of the string, **respecting the direction of the arrow** found on the clamp itself as indicated in Fig. 5 or Fig. 6. Position the clamp toroid as far as possible from the inverter and from the negative output conductor of the string itself.
11. Repeat the operations described in the two steps above for other possible DC power trackers to be monitored by using the **IDC2** and **IDC3** inputs according to the number of DC inputs set (see § 5.2.1.1).
12. Connect the **VAC1** and **N** inputs of unit **MPP300** to the Phase and Neutral conductors respectively, respecting the polarities and the colors indicated in Fig. 5 or Fig. 6. In case of three-phase systems in which no Neutral conductor is available, connect input **N** to earth.
13. In case of inverter with three-phase output (see settings in § 5.2.1.1), repeat the operation described in the step above for the remaining phases by using the **VAC2** and **VAC3** inputs of MPP300.
14. Connect the AC clamp to the Phase L1 conductor, **respecting the direction of the arrow** found on the clamp itself as indicated in Fig. 5 or Fig. 6. Position the clamp toroid as far as possible from the inverter and from the Neutral conductor. Connect the clamp output to the **IAC1** input of MPP300.
15. In case of inverter with three-phase output (see settings in § 5.2.1.1), repeat the operation described in the step above for the remaining phases by using the **IAC2** and **IAC3** inputs of MPP300.
16. Restore the operation of the electrical system being measured.

17. The display of SOLAR I-Vw or SOLAR I-Ve will show the values of the **general** electrical parameters of the system being measured. In particular, in this screen:

- Pdc = General DC power (sum of the string powers)
- Pac = AC power (if single-phase) or sum of the ac powers (if three-phase)

15/05/10	15:34:26	
PRp	- - -	
Irr	- - -	W/m ²
Pnom	3.500	kW
Tc	- - -	°C
Te	- - -	°C
Pdc	3.125	kW
Pac	2.960	kW
ndc	- - -	
nac	0.95	
GO - start rec		
Select		MPP

We recommend checking that the values of the electrical parameters (Pnom, Pdc, Pac) and of the ac performance (η_{ac}) are consistent with the system being measured (e.g.: $\eta_{ac} > 1$ is not physically acceptable)

18. On SOLAR I-Vw or SOLAR I-Ve, press key (▼) to access the second screen which contains the values of the output DC parameters of the strings according to the number of DC inputs set (see § 5.2.1.1). In particular, in this screen:

- Vdcx = DC voltage of string x
- Idcx = DC current of string x
- Pdcx = DC power of string x.

We recommend checking that the values of the electrical parameters (Vdc, Idc, Pdc) are consistent with the system being measured.

15/05/10 15:34:26		▲
Vdc1	460.1	kW
Vdc2	461.4	V
Vdc3	462.5	A
Idc1	2.25	A
Idc2	2.31	A
Idc3	2.21	A
Pdc1	1.035	kW
Pdc2	1.066	kW
Pdc3	1.024	kW
GO – start rec		▼
Select		MPP

19. On SOLAR I-Vw or SOLAR I-Ve, press key (▼) to access the third screen which contains the values of the electrical parameters on the AC side of the inverter, consistently with the settings made in § 5.2.2 (single-phase, three-phase 4 wires). In particular, in this screen:

- Vacxy = AC voltage between Phase and Neutral (if single-phase) or between Phases x and y (if three-phase)
- Iacx = AC current of phase x
- Pacx = AC power of phase x

We recommend checking that the values of the electrical parameters (Vac, Iac, Pac) are consistent with the system being measured.

15/05/10 15:34:26		▲
Vac12	401.4	V
Vac23	401.1	V
Vac31	400.1	V
Iac1	4.26	A
Iac2	4.26	A
Iac3	4.27	A
Pac1	987	W
Pac2	986	W
Pac3	985	W
GO – start rec		▼
Select		MPP

Example of a screen for PV systems with three-phase output

20. Keeping the three instruments near each other (max distance approx. 1m), press the **GO/STOP** key on SOLAR I-Vw or SOLAR I-Ve to start testing. Consequently:

- The display of SOLAR I-Vw or SOLAR I-Ve shows the message “**rec. start waiting**”
- The display of SOLAR-02 shows the message “**HOLD**” and the time, expressed in seconds, remaining before the recording is started
- On MPP300, the STATUS LED turns on green (not flashing)

15/05/10 15:34:26		▲
PRp	- - -	
Irr	- - -	W/m ²
Pnom	3.500	kW
Tc	- - -	°C
Te	- - -	°C
Pdc	3.125	kW
Pac	2.960	kW
ndc	- - -	
nac	0.95	
Rec. running		▼
Select		MPP

21. Upon reaching the instant “00” after pressing the **GO/STOP** key, the test is started and the three units are synchronized with each other. In these conditions:

- The display of SOLAR I-Vw or SOLAR I-Ve shows the message “**rec. running**”
- The display of SOLAR-02 shows the message “**Recording...**”
- On MPP300, the STATUS LED flashes green



15/05/10 15:35:00		▲
PRp	- - -	
Irr	- - -	W/m ²
Pnom	3.500	kW
Tc	- - -	°C
Te	- - -	°C
Pdc	3.125	kW
Pac	2.960	kW
ndc	- - -	
nac	0.95	
Rec. running		▼
Select		MPP

22. At any time it will be possible to analyze the current recording status by pressing the **MENU** key. The following information will be shown:



- Starting date and time of recording
- The value set for the integration period
- The number of periods elapsed from the beginning of the recording
- The remaining memory capacity for recording

15/05/10 15:35:00	
Start	17:18:00
14/02/00	
Period:	5s
IP Number	61
Rec. Time	0d 1h
Rec. Running	
Select	MPP 

Press the **ESC** key to exit the screen

23. Now it is possible to bring the unit SOLAR-02 near the PV strings to measure irradiation and temperature by means of the relevant probes. When the distance between unit SOLAR-02 and MPP300 does not allow the RF connection, on the display of SOLAR-02 the symbol “” flashes for approx. 30s and then disappears. Unit MPP300 steadily searches for the RF connection with unit SOLAR-02.
24. Position the reference cell onto the surface of the PV modules. Please refer to the relevant User Manual for a correct assembly.
25. Put the temperature sensor in contact with the rear side of the module and fasten it with some tape; prevent touching it with your fingers (as this could alter the measure).
26. Wait for a few seconds to allow the probes to reach a steady measure and then connect the irradiation probe to input **PYRA/CELL** and the temperature probe to input **TEMP** of unit SOLAR-02.
27. Wait for the message “**READY**” to appear on the display of SOLAR-02 to indicate that the unit has detected the data with solar irradiation > minimum threshold set (see § 5.1.5).
28. **With the message “READY” shown on the display, wait for approximately 1 minute in order to take a certain number of samples.**
29. Disconnect the irradiation and temperature probes from unit SOLAR-02 and bring the unit near unit MPP300. Bring the main unit SOLAR I-Vw or SOLAR I-Ve near MPP300 too. The three units must be near each other (max distance 1m).
30. The main unit SOLAR I-Vw or SOLAR I-Ve must be in **EFF** mode; if no flashing symbol “” appears, press key **▲** to activate the RF connection search again.
31. Press key **▼** on SOLAR-02 to activate the RF connection again. Consequently, the main unit will show the message “active radio connection”.

32. To stop testing, press the **GO/STOP** key on instrument SOLAR I-Vw or SOLAR I-Ve and confirm pressing **ENTER** that you want to stop recording.
33. The display of SOLAR I-Vw or SOLAR I-Ve will show the message “**DATA DOWNLOAD**” to indicate that the data will be transferred to the main unit during its various phases.
34. After the automatic data transfer phase, the instrument:
- Do not show any results if do not exist on the PV installation a “**stable irradiance**” condition more than the minimum irradiance threshold.
 - Display the best performance values if during the recording, the Irradiance values reached the “**stable**” condition and its values were higher than the minimum irradiance threshold.
35. Press **SAVE** to save the results (see § 7.1) or **ESC** to exit the screen of the results and go back to the initial screen.

15/05/10 15:35:00		
▲		
PRp	0.815	
Irr	971	W/m ²
Pnom	3.500	kW
Tc	45.1	°C
Te	30.5	°C
Pdc	3.125	kW
Pac	2.960	kW
ndc	0.806	
nac	0.947	
Analysis Result		
Select	EFF	

6.2. I-V CURVE MEASUREMENT

The meter can perform I-V curve tests in automatic or manual activation mode by using one of the herewith modes:

- I-V curve test with Irr/Temp measurement directly performed by the instrument
- I-V curve test with Irr/Temp measurement performed by use of remote unit SOLAR-02

For theoretical information on measurement see the § 11.1

6.2.1. I-V curve measurement by use of instrument



CAUTION

- The maximum voltage among P1, P2, C1, and C2 inputs is 1000V DC (for I-V400w and SOLAR I-Vw) or 1500VDC (for I-V500w and SOLAR I-Ve). Do not measure voltages exceeding the limits prescribed by this manual
- The maximum current measured by the meter is 15A. Do not perform test on strings of PV modules in parallel with them
- Do not perform test on PV modules or strings connected to DC/AC converter

1. Turn on the meter by pressing **ON/OFF** key
2. Check that option NO relative to the selection of remote unit SOLAR-02 should be set on the instrument (see § 5.1.4)
3. Check that the values set on the “Remote unit” section (see § 5.1.4) should be consistent with the reference cell depending on the kind of module/string on test
4. Check that the value set on “Irradiance” section (see § 5.1.5) should be consistent with the measurement to perform. It is suggested to perform the measurement with a threshold $\geq 700 \text{ W/m}^2$ in compliance to the IEC/EN60891 guideline
5. Back to the main menu and select the “I-V” option
6. Press **ENTER**, by means of arrow keys (**▲**, **▼**) select item “**Meas. Type ▶**”
7. Using the **▶** key, select item “**I-V Test**” and confirm by pressing **ENTER**

15/05/10 15:34:26	
Vdc	= 0.0 V
Irr	= 0 W/m ²
Tc	= - - - °C
Module: SUNPOWER 210	
I-V Test	
Set	IV Fast Check
Mea	
Select	I-V

8. The instrument displays a screen similar to the one reported here to the side, where:

- Vdc = DC output voltage from module measured between C1 and C2 inputs of meter
- Irr = irradiance measured by supplied reference cell
- Tc = temperature of module cell. The herewith options are available for this field:
 - AUTO → automatic mode of temperature measurement
 - Number → MAN or AUX mode of temp. measurement
 - “ - - - ” → AUX mode with no connected probe
- Module = type of selected module
- Temp = measurement mode of module temperature
- Start = measurement activation mode

15/05/10 15:34:26	
Vdc	= 0.0 V
Irr	= - - - W/m ²
Tc	= Auto
Module: PANEL01	
Temp: Auto	
Start: Manual	
Select	I-V

9. Press **ENTER** key, select the “**Settings**” item and confirm again with **ENTER** to access the next screen which allows setting the type of PV module and the number of modules relative to the PV string under test.

15/05/10	15:34:26	█
Vdc = 0.0 V		
Irr = - - - W/m2		
Tc = - - - °C		
Module: PANEL01		
Settings		
Meas. Type ▶		
Select	I - V	

10. By means of arrow keys (◀,▶) select the type of PV module included in the database of meter (§ 5.3.1).

11. By means of arrow keys (▲,▼) select the item “N. of Mod.” and by means of arrow keys (◀,▶) set the number of modules of the PV string under test. The maximum number of modules is **50**

12. By means of arrow keys (▲,▼) select the “Oper. yrs” item and by means of arrow keys (◀,▶) set the service operating years of the PV module/string/field from start installation (see § 6.2.3). The maximum set value is **25.0 (0.5 = 6 months)**

15/05/10	15:34:26	█
Type : ◀ SUNPOWER 210 ▶		
N. of Mod. : 15		
Oper. yrs: 4.5		
Temp : Auto		
Start : Manual		
Pmax = 210		
Voc = 47.70		
Vmpp = 40.00		
Isc = 5.75		
Impp = 5.25		
		SET

13. By means of arrow keys (◀,▶) select the type of PV module included in the database of meter (§ 5.3.1). By means of arrow keys (▲,▼) select the “Temp” item and by means of arrow keys (◀,▶) choose the type of module temperature among the modes listed:

- **Auto** → automatic measurement performed by the meter depending on the measured value of open voltage of the modules (**recommended method**)
- **Manual** → setting of a module temperature value by the operator on the corresponding “**Value**” field
- **Aux** → setting of temperature of module performed by auxiliary probe

14. By means of arrow keys (▲,▼) select the “Start” item and by means of arrow keys (◀,▶) choose the type of measurement activation between the modes listed:

- **Auto** → test automatically activated by the instrument with stable values of voltage among inputs for at least 1s and with values within the measurement range (see § 10.2)
- **Manual** → test activated from the user by press of **GO/STOP** key

15. Confirm with **SAVE** key or press **ESC/MENU** key to exit without saving

16. Mount the M304 (inclinometer) supplied accessory, place and hold it on the plane of module.

Verify that the sun shadow falls on the disc within the “limit internal circle” on the disc itself (see Fig. 7b). If this is not the case, the incidence angle between sun rays and the module surface is too high and not complying with the test conditions declared by the module manufacturer. As a consequence the measurements performed by the meter are not ok and all measurements steps shall be repeated at another daytime

17. Fix the support of the cell to the module by using the supplied set of screws and mount the reference cell on it possibly with **output terminals downwards with respect to the module**. Rotate the cell upwards to lean it on the small wing of the support so as the cell is perfectly parallel to the plane of module, then fix it with the relevant screws supplied

18. Connect the output of reference cell (depending on the type of module under test) of reference cell at the **IRR.** input of meter by using the cable supplied with the cell

19. Connect, if used, the auxiliary temperature probe (optional accessory) to the **AUX** input of meter and on the rear of module, fixing it with adhesive tape
20. Connect the meter to the module/string under test as shown in Fig. 7a. In particular, connect the negative output pole of module/string to P1, C1 input terminals and the positive output pole of module/string to P2, C2 input terminals. In **Auto** activation mode is recommended the use of KITKELVIN optional accessory

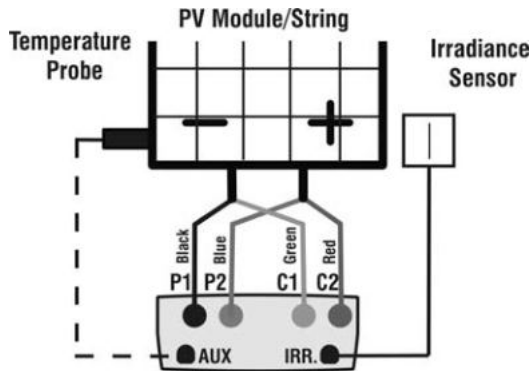

Fig. 7a: Instrument connection to module/string FV

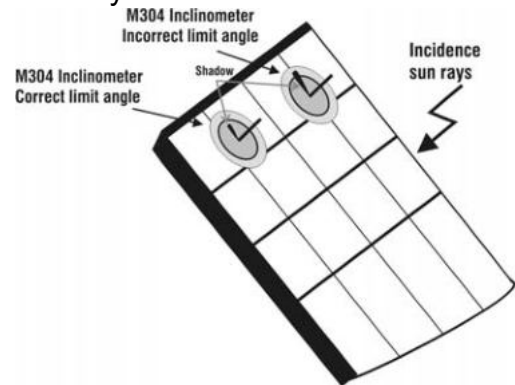

Fig. 7b: Positioning of inclinometer M304

CAUTION



The method used by the instrument meter for output VDC and IDC measurements of PV module/string is the “4-wire”. Therefore, it is possible to use also test cables connected to P1, C1, P2, C2 inputs of different length without performing any calibration of cable resistance. **It is recommended to use cables with a $\xi \geq 4\text{mm}^2$**

21. After connection to the plant, the real time values of parameters are shown by meter:
 - Vdc = DC output voltage of PV module/string
 - Irr = Irradiance value measured by sensor
 - Tc = Value of module temperature

15/05/10	15:34:26	█
Vdc	=	367 V
Irr	=	1045 W/m²
Tc	=	45 °C
Module: SUNPOWER 210		
Select	I - V	

CAUTION



At the press of **GO/STOP** key some different error messages can be displayed by the meter (see § 6.4) and, due of this, the test cannot start. Check and remove, if possible, this error message before start the test

22. Press **GO/STOP** key (in Manual activation mode) to start the test. If none of the previous error messages are detected, the message “**Measuring...**” is shown on the display for some seconds, depending on the level of power during test.

15/05/10	15:34:26	█
Vdc	=	367 V
Irr	=	1045 W/m²
Tc	=	45 °C
Module: SUNPOWER 210		
Measuring...		
Select	I - V	

23. At the end of test, the values of typical parameters (all referred to a single module in standard conditions STC) are shown by the meter together with the final response (§ 6.2.3) based on the automatic calculation performed and relevant to:

- Translation of I-V curve to STC condition
- Verification of tolerance % of the maximum power declared by the manufacturer.

15/05/10	15:34:26	
Voc	=	15.2 V
Vmpp	=	14.7 V
Impp	=	4.7 A
Isc	=	5.2 A
Pmax	=	200 W
FF	=	77.1 %
DPmax	=	2.1 %
Results @ STC – Response: OK		
Select		I - V



CAUTION

- The instrument refer all the values of parameters to one only module at the STC condition
- The total voltage of the string, obtained at OPC, is divided for the number of module of it. Considering this “average” value, together with the measured current, the instrument perform the I-V curve @ OPC calculation which is the translated at the STC condition

24. Press **ENTER** for the display of measurement results both in numeric and graphical mode referred to STC or OPC conditions (see § 6.2.3).

25. Use the arrow key ► for the selection of table or graph visualization.

26. Press **SAVE** key to store the result of test (see § 7.2) or **ESC/MENU** key to exit without saving and to go back to the main menu

27. The “**Auto**” activation mode require to disconnect and reconnect the test leads in order to start automatically a new measurement

15/05/10	15:34:26	
Voc	=	15.2 V
Vmpp	=	14.7 V
Impp	=	4.7 A
Isc	=	5.2 A
Pmax	=	200 W
FF	=	77.1 %
DPmax	=	2.1 %
Table	►	
Graph	►	– Response: OK
Select		I - V

6.2.2. I-V curve measurement by use of remote unit SOLAR-02

The I-V curve test with Irr/Temp measurement by use of remote unit SOLAR-02 can be performed in one of the herewith mode:

- Remote unit SOLAR-02 in RF connection with main unit
- Remote unit SOLAR-02 in synchro recording (no RF connection with main unit)

6.2.2.1. I-V curve test by remote unit SOLAR-02 in RF connection

This mode is possible ONLY if the distance between the main unit and the remote unit SOLAR-02 can establish always a stable RF connection. This distance limit is influenced by obstacles, air humidity, etc., so it is considered valid about some meters.



CAUTION

- The maximum voltage among P1, P2, C1, and C2 inputs is 1000V DC (for I-V400w and SOLAR I-Vw) or 1500VDC (for I-V500w and SOLAR I-Ve). Do not measure voltages exceeding the limits prescribed by this manual
- The maximum current measured by the meter is 15A. Do not perform test on strings of PV modules in parallel with them
- Do not perform test on PV modules or strings connected to DC/AC converter

1. Turn on the meter by pressing **ON/OFF** key
2. Check that option YES relative to the selection of remote unit SOLAR-02 should be set on the instrument (see § 5.1.4)
3. Check that the values set on the “Remote unit” section (see § 5.1.4) should be consistent with the reference cell depending on the kind of module/string on test
4. Check that the value set on “Irradiance” section (see § 5.1.5) should be consistent with the measurement to perform. It is suggested to perform the measurement with a threshold $\geq 700 \text{ W/m}^2$ in compliance to the IEC/EN60891 guideline
5. **Back to the main menu and select the “I-V” option**
6. Press **ENTER**, by means of arrow keys (**▲**, **▼**) select item “**Meas. Type ▶**”
7. Using the **▶** key, select item “**I-V Test**” and confirm by pressing **ENTER**

15/05/10 15:34:26 █	
Vdc	= 0.0 V
Irr	= 0 W/m²
Tc	= - - - °C
Modulo: SUNPOWER 210	
I-V Test	
Set	IV Fast Check
Mea	█
Select	I-V

8. **Switch on the remote unit SOLAR-02 and wait that “Radio connection active” message is displayed**

9. The instrument displays :

- Vdc = DC output voltage from module/string
- Irr = irradiance measured by supplied reference cell
- Tc = temperature of module. The herewith options are available for this field:
 - AUTO → automatic mode
 - Number → MAN or AUX mode
 - “ - - - ” → AUX mode with no connected probe
- Module = type of selected module
- Temp = measurement mode of module temperature
- Start = measurement activation mode
- The symbol “” **fixed** at display means that a stable RF connection is established with the remote unit

15/05/10 15:34:26	
Vdc =	0.0 V
Irr =	- - - W/m ²
Tc =	Auto °C
Module: PANEL01	
Temp: Auto	
Start: Manual	
Select	I - V

10. Press **ENTER** key, select the “**Settings**” item and confirm again with **ENTER** to access the next screen which allows setting the type of PV module and the number of modules relative to the PV string under test.

15/05/10 15:34:26	
Vdc =	0.0 V
Irr =	- - - W/m ²
Tc =	- - - °C
Module: PANEL01	
Settings	
Meas. Type	▶
Select	I - V

11. By means of arrow keys (◀,▶) select the type of PV module included in the database of meter (§ 5.3.1)

12. By means of arrow keys (▲,▼) select the item “N. of Mod.” and by means of arrow keys (◀,▶) set the number of modules of the PV string under test. The maximum number of modules is **50**

13. By means of arrow keys (▲,▼) select the “Oper. yrs” item and by means of arrow keys (◀,▶) set the service operating years of the PV module/string/field from start installation (see § 6.2.3). Maximum set value is **25.0 (0.5 = 6 months)**

15/05/10 15:34:26	
Type :	◀ SUNPOWER 210 ▶
N. of Mod. :	15
Oper. yrs :	4.5
Temp :	Auto
Start :	Manual
Pmax =	210
Voc =	47.70
Vmpp =	40.00
Isc =	5.75
Impp =	5.25
SET	

14. By means of arrow keys (◀,▶) select the type of PV module included in the database of meter (§ 5.3.1). By means of arrow keys (▲,▼) select the “Temp” item and by means of arrow keys (◀,▶) choose the type of module temperature among the modes:

- **Auto** → automatic measurement performed by the meter depending on the measured value of open voltage of modules (**recommended method**)
- **Manual** → setting of a module temperature value by the operator on the corresponding **Value** field
- **Aux** → setting of temperature of module performed by auxiliary probe

15. By means of arrow keys (▲,▼) select the “Start” item and by means of arrow keys (◀,▶) choose the type of measurement activation between the modes listed:

- **Auto** → test automatically activated by the instrument with stable values of voltage among inputs for at least 1s and with values within the measurement range (see § 10.2)
- **Manual** → test activated from the user by press of **GO/STOP** key

16. Confirm with **SAVE** key or press **ESC/MENU** key to exit without saving

17. Mount the M304 (inclinometer) supplied accessory, place and hold it on the plane of module. **Verify that the sun shadow falls on the disc within the “limit internal circle” on the disc itself (see Fig. 8). If this is not the case, the incidence angle between sun rays and the module surface is too high and not complying with the test conditions declared by the module manufacturer. As a consequence the measurements performed by the meter are not ok and all measurements steps shall be repeated at another daytime**
18. Fix the support of the cell to the module by using the supplied set of screws and mount the reference cell on it possibly with **output terminals downwards with respect to the module**. Rotate the cell upwards to lean it on the small wing of the support so as the cell is perfectly parallel to the plane of module, then fix it with the relevant screws supplied
19. Connect the output of reference cell (depending on the type of module under test) at the **PYRA/CELL** input of remote unit SOLAR-02 by using the supplied cable
20. Connect, if used, the auxiliary temperature probe to the **TEMP** input of remote unit SOLAR-02 and on the rear of module, fixing it with adhesive tape
21. Connect the meter to the module/string under test as shown in Fig.9. In particular, connect the negative output pole of module/string to P1, C1 input terminals and the positive output pole of module/string to P2, C2 input terminals. In **Auto** activation mode is recommended the use of KITKELVIN optional accessory

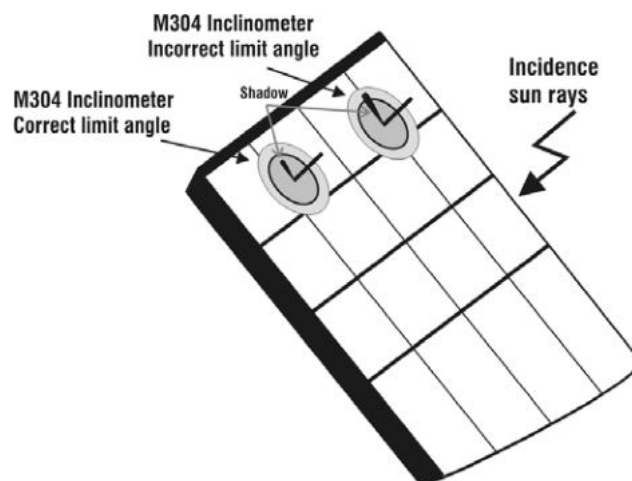

Fig. 8: Positioning the M304 inclinometer

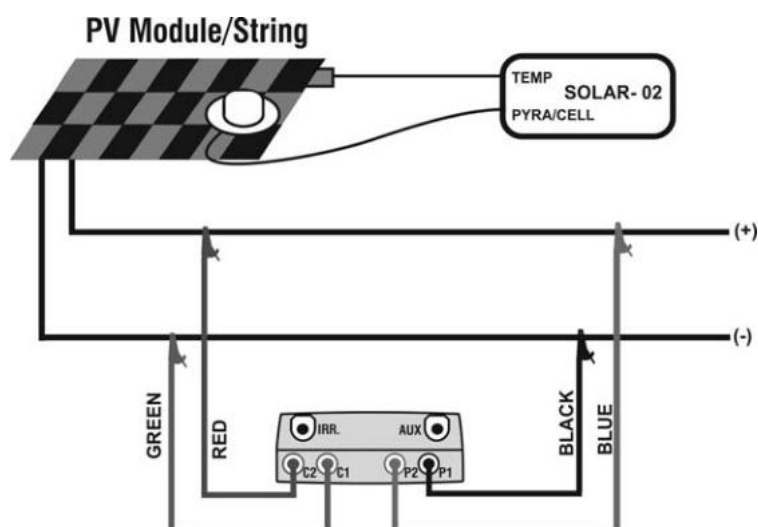

Fig. 9: Connection of units to the PV module/string

22. The instrument displays:

- Vdc = DC output voltage from module/string.
- Irr = irradiance measured by supplied reference cell
- Tc = temperature of module. The herewith options are available for this field:
 - AUTO → automatic mode of temperature measurement
 - Number → MAN or AUX mode of temp. measurement
 - “ - - - ” → AUX mode with no connected probe
- Module = type of selected module
- Temp = measurement mode of module temperature
- Start = measurement activation mode
- The symbol “” fixed at display means that a stable RF connection is established with the SOLAR-02

15/05/10	15:34:26	
Vdc	=	367 V
Irr	=	1045 W/m²
Tc	=	45 °C
Module: SUNPOWER 210		
Temp: Auto		
Start: Manual		
Select	I - V	



CAUTION

At the press of **GO/STOP** key some different error messages can be displayed by the meter (see § 6.3) and, due of this, the test cannot start. Check and remove, if possible, this error message before start the test

23. Press **GO/STOP** key (in Manual activation mode) to start the test. If none of the previous error messages are detected, the message “**Measuring...**” is shown on the display for some seconds, depending on the level of power during test.

15/05/10	15:34:26	
Vdc	=	367 V
Irr	=	1045 W/m²
Tc	=	45 °C
Module: SUNPOWER 210		
Measuring...		
Select	I - V	

24. At the end of test, the values of typical parameters (all referred to a single module in standard conditions STC) are shown by the meter together with the final response (§ 6.2.3) based on the automatic calculation performed and relevant to:

- Translation of I-V curve to STC condition
- Verification of tolerance % of the maximum power declared by the manufacturer.

15/05/10	15:34:26	
Voc	=	15.2 V
Vmpp	=	14.7 V
Impp	=	4.7 A
Isc	=	5.2 A
Pmax	=	200 W
FF	=	77.1 %
DPmax	=	2.1 %
Results @ STC – Response: OK		
Select	I - V	

25. Press **ENTER** for the visualization of measurement results referred at STC or OPC conditions both in numeric and graphical mode (§ 6.2.3)

26. Use the arrow key for the selection of table or graph visualization

27. Press **SAVE** key to store the result of test (see § 7.2) or **ESC/MENU** key to exit without saving and to go back to the main menu

28. The “**Auto**” activation mode require to disconnect and reconnect the test leads in order to start automatically a new measurement

15/05/10	15:34:26	
Voc	=	15.2 V
Vmpp	=	14.7 V
Impp	=	4.7 A
Isc	=	5.2 A
Pmax	=	200 W
FF	=	77.1 %
DPmax	=	2.1 %
Table		
Graph – Response: OK		
Select	I - V	

6.2.2.2. I-V curve test by remote unit SOLAR-02 in synchro recording

This mode, which consists in an independent recording of the irradiance and temperature parameters by the remote unit SOLAR-02, permits to perform I-V curve test also with wide distance between the instrument and SOLAR-02 without any connection between them.

On the other hand, due to the impossibility for the meter to have immediately the values of irradiance/temperature, it is necessary wait the transfer of data from remote unit SOLAR-02 to main unit in order to have all the available results.



CAUTION

- The maximum voltage among P1, P2, C1, and C2 inputs is 1000V DC (for I-V400w and SOLAR I-Vw) or 1500VDC (for I-V500w and SOLAR I-Ve). Do not measure voltages exceeding the limits prescribed by this manual
- The maximum current measured by the meter is 15A. Do not perform test on strings of PV modules in parallel with them
- Do not perform test on PV modules or strings connected to DC/AC converter



1. Turn on the meter by pressing **ON/OFF** key
2. Check that option YES relative to the selection of remote unit SOLAR-02 should be set on the instrument (see § 5.1.4)
3. Check that the value set on “Irradiance” section (see § 5.1.5) should be consistent with the measurement to perform. It is suggested to perform the measurement with a threshold $\geq 700 \text{ W/m}^2$ in compliance to the IEC/EN60891 guideline
4. Back to the main menu and select the “I-V” measurement mode
5. Press **ENTER**, by means of arrow keys (**▲**, **▼**) select item “**Meas. Type ▶**”
6. Using the **▶** key, select item “**I-V Test**” and confirm by pressing **ENTER**

15/05/10 15:34:26	
Vdc =	0.0 V
Irr =	0 W/m2
Tc =	- - - °C
Module: SUNPOWER 210	
	I-V Test
Set	IV Fast Check
Mea	
Select	I-V

7. Switch on the remote unit SOLAR-02 and wait that “Radio connection active” is displayed
8. Check the status of internal batteries of SOLAR-02 (the “” symbol should be not displayed)
9. Check that the values of sensitivity and temperature coefficient set on the SOLAR-02 section should be consistent with the reference cell depending on the kind of module/string on test (see user manual of SOLAR-02)

10. The instrument displays:

- Vdc = DC output voltage from module/string
- Irr = irradiance measured by supplied reference cell
- Tc = temperature of module. The herewith options are available for this field:
 - AUTO → automatic mode of temperature measurement
 - Number → MAN or AUX mode of temp. measurement
 - “ - - - ” → AUX mode with no connected probe
- Module = type of selected module
- Temp = measurement mode of module temperature
- Start = measurement activation mode
- The symbol “ fixed at display means that a stable RF connection is established with the SOLAR-02

15/05/10	15:34:26	
Vdc =	0.0 V	
Irr =	- - - W/m ²	
Tc =	Auto °C	
Module: PANEL01		
Temp: Auto		
Start: Manual		
Select	I - V	

11. Press **ENTER** key, select the “**Settings**” item and confirm again with **ENTER** to access the next screen which allows setting the type of PV module and the number of modules relative to the PV string under test.

15/05/10	15:34:26	
Vdc =	0.0 V	
Irr =	- - - W/m ²	
Tc =	- - - °C	
Module: PANEL01		
Settings		
Meas. Type		▶
Select	I - V	

12. By means of arrow keys (◀, ▶) select the type of PV module included in the database of meter (§ 5.3.1)

13. By means of arrow keys (▲, ▼) select the item “N. of Mod.” and by means of arrow keys (◀, ▶) set the number of modules of the PV string under test. The maximum number of modules is **50**

14. By means of arrow keys (▲, ▼) select the “Oper. yrs” item and by means of arrow keys (◀, ▶) set the service operating years of the PV module/string/field from start installation (see § 6.2.3). Maximum set value is **25.0 (0.5 = 6 months)**

15/05/10	15:34:26	
Type : ◀ SUNPOWER 210 ▶		
N. of Mod. : 15		
Oper. yrs : 4.5		
Temp : Auto		
Start : Manual		
Pmax = 210		
Voc = 47.70		
Vmpp = 40.00		
Isc = 5.75		
Impp = 5.25		
		SET

15. By means of arrow keys (◀, ▶) select the type of PV module included in the database of meter (§ 5.3.1). By means of arrow keys (▲, ▼) select the “Temp” item and by means of arrow keys (◀, ▶) choose the type of module temperature among the modes:

- **Auto** → automatic measurement performed by the meter depending on the measured value of open voltage of modules (**recommended method**)
- **Manual** → setting of a module temperature value by the operator on the corresponding **Value** field
- **Aux** → setting of temperature of module performed by auxiliary probe

16. By means of arrow keys (▲, ▼) select the “Start” item and by means of arrow keys (◀, ▶) choose the type of measurement activation between the modes listed:

- **Auto** → test automatically activated by the instrument with stable values of voltage among inputs for at least 1s and with values within the measurement range (see § 10.2)
- **Manual** → test activated from the user by press of **GO/STOP** key

17. Confirm with **SAVE** key or press **ESC/MENU** key to exit without saving

18. Mount the M304 (inclinometer) supplied accessory, place and hold it on the plane of module. **Verify that the sun shadow falls on the disc within the “limit internal circle” on the disc itself (see Fig. 10).** If this is not the case, the incidence angle between sun rays and the module surface is too high and not complying with the test conditions declared by the module manufacturer. As a consequence the measurements performed by the meter are not ok and all measurements steps shall be repeated at another daytime
19. Fix the support of the cell to the module by using the supplied set of screws and mount the reference cell on it possibly with **output terminals downwards with respect to the module**. Rotate the cell upwards to lean it on the small wing of the support so as the cell is perfectly parallel to the plane of module, then fix it with the relevant screws supplied
20. Connect the output of reference cell (depending on the type of module under test) at the **PYRA/CELL** input of remote unit SOLAR-02 by using the supplied cable
21. Connect, if used, the auxiliary temperature probe to the **TEMP** input of remote unit SOLAR-02 and on the rear of module, fixing it with adhesive tape
22. Connect the meter to the module/string under test as shown in Fig.11. In particular, connect the negative output pole of module/string to P1, C1 input terminals and the positive output pole of module/string to P2, C2 input terminals. In **Auto** activation mode is recommended the use of KITKELVIN optional accessory

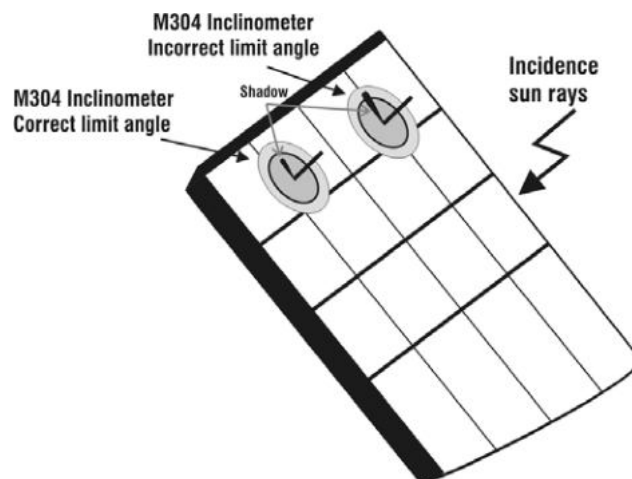

Fig. 10: Positioning the M304 inclinometer

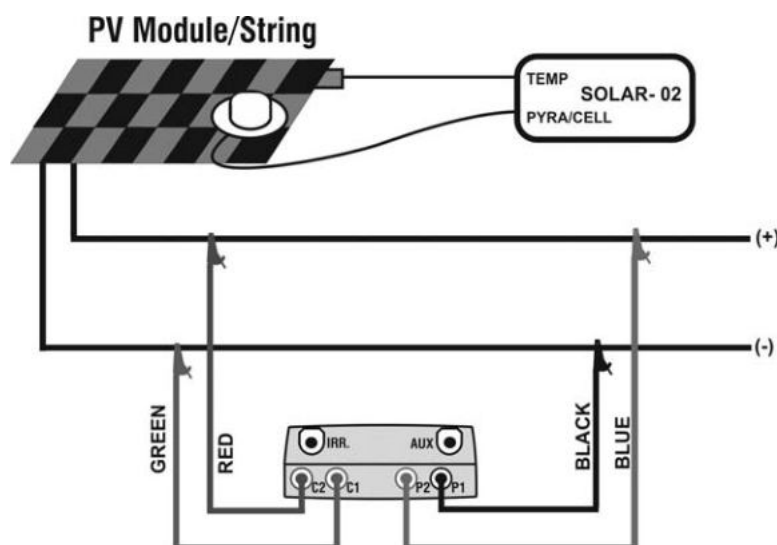







Fig.11: Connection of units to the PV module/string

23. The instrument displays:

- Vdc = DC output voltage from module/string
- Irr = irradiance measured by supplied reference cell
- Tc = temperature of module. The herewith options are available for this field:
 - AUTO → automatic mode of temperature measurement
 - Number → MAN or AUX mode of temp. measurement
 - “ - - - ” → AUX mode with no connected probe
- Module = type of selected module
- Temp = measurement mode of module temperature
- Start = measurement activation mode
- The symbol “ fixed at display means that a stable RF connection is established with the remote unit SOLAR-02

15/05/10 15:34:26 	
Vdc =	367 V
Irr =	1045 W/m²
Tc =	45 °C
Module: SUNPOWER 210 Temp: Auto Start: Manual	
Select	I - V 

24. Press **ENTER** key, select the “**Activate Rec.**” item and confirm with **ENTER**. The message “Remote unit in recording...” is displayed on the meter. In this condition is possible to start the I-V curve tests always considering that the complete results will be available only after the stop of recording of SOLAR-02 and transfer them from the same remote unit

15/05/10 15:34:26 	
Vdc =	0.0 V
Irr =	- - - W/m²
Tc =	- - - °C
Activate Rec.	
Settings	
Meas. Type ▶	
Select	I - V 



CAUTION

At the press of **GO/STOP** key some different error messages can be displayed by the meter (see § 6.4) and, due of this, the test cannot start. Check and remove, if possible, this error message before start the test

25. Press **GO/STOP** key (in Manual activation mode) to start the test. If none of the previous error messages are detected, the message “**Measuring...**” is shown on the display for some seconds, depending on the level of power during test.

15/05/10 15:34:26 	
Vdc =	367 V
Irr =	- - - W/m²
Tc =	Auto °C
Module: SUNPOWER 210	
Measuring...	
Select	I - V

26. At the end of test, based on the descriptions of previous points, the message “STC Data available after Stop rec” is displayed and then the results at OPC conditions are displayed

15/05/10	15:34:26	[REDACTED]	
Voc	=	15.2	V
Vmpp	=	14.7	V
Imp	=	4.7	A
Isc	=	5.2	A
Pmax	=	200	W
FF	=	77.1	%
Irr	=	- - -	W/m ²
Tc	=	Auto	
Results @ OPC			
Select	I - V		

27. Press **ENTER** for the visualization of measurement results both in numeric and graphical mode (§ 6.2.3)

28. Use the arrow key **▶** for the selection of table or graph visualization

29. Press **SAVE** key to store the result of test or **ESC/MENU** key to exit without saving and to go back to the main screen

30. The “**Auto**” activation mode require to disconnect and reconnect the test leads in order to start automatically a new measurement

15/05/10	15:34:26	[REDACTED]	
Voc	=	15.2	V
Vmpp	=	14.7	V
Imp	=	4.7	A
Isc	=	5.2	A
Pmax	=	200	W
FF	=	77.1	%
Irr	=	- - -	W/m ²
Table ▶			
Graph ▶			
Select	I - V		

31. At the end of I-V test, press the **ENTER** key, select the “**Stop recording**” item and confirm with **ENTER**. The messages “Wait...” and then “STC Data available in MEM” are displayed

32. In this conditions, for the I-V tests performed with irradiance values over the limit threshold and stable, the correspondent STC results will be available inside memory

15/05/10	15:34:26	[REDACTED]	
Vdc	=	0.0	V
Irr	=	- - -	W/m ²
Tc	=	Auto	°C
Stop Reg.			
Settings			
Meas. Type ▶			
Select	I - V		

33. The message “**Download data**” is displayed on the instrument and, at the same time, the message “**Send**” is displayed on SOLAR-02 which means the transfer of irradiance values and, if necessary, the module temperature values on the main unit

34. At the end of data transfer the instrument **automatically** join the average value of irradiance (detected with IP = 5s) to each I-V test performed and, correspondingly, will calculate the results translated to STC conditions and the Yes/No response for each test. The complete results are recalled at display as described in § 7.3.2. See the § 6.2.3 for the meaning of measurement results

6.2.3. Meaning of measurement results

The parameter measured and calculated by meter have the following meaning:

Parameter	Description
Pmax	Maximum power of module measured by the meter
DPmax	Difference % of maximum measured power from nominal power (@ STC)
FF	Fill Factor %
Voc	Open voltage
Vmpp	Voltage on point of maximum power
Isc	Short circuit current
Impp	Current on point of maximum power

Table 2: List of parameter measured by the meter

Where:

$$DP_{\%}^{MAX} = 100 \times \frac{P^{MAX} - P_{Age}^{Nom}}{P_{Age}^{Nom}} \rightarrow \text{check parameter which defines the final test response}$$

$$P_{Age}^{Nom} = P^{Nom} \times \left(1 - \frac{Oper.Yrs \times YearDegr\%}{100} \right) \quad P^{Nom} = \text{nominal power of module}$$

FF = 100 x [(Vmpp x Impp) / (Voc x Isc)] = Fill Factor → represents a kind of “efficiency” of module/string as it is a ratio between the maximum power measured and the open power

The meter gives the following final response:

Response	Condition	Note
OK	$- Tol^{(-)} + \varepsilon^{Meter} \leq \varepsilon^{Meas} \leq Tol^{(+)} - \varepsilon^{Meter}$	(1)
OK*	The previous relation (1) is not verified but the following is valid: $- Tol^{(-)} \leq \varepsilon^{Meas} \leq Tol^{(+)}$	(2)
NO OK*	The relations (1) and (2) are not verified but the following is valid: $- Tol^{(-)} - \varepsilon^{Meter} \leq \varepsilon^{Meas} \leq Tol^{(+)} + \varepsilon^{Meter}$	(3)
NO OK	None of the relations (1), (2) and (3) are verified	(4)

where:

$Tol^{(-)} = Tol^{(-)} (\%) * P^{nom} \rightarrow$ Negative tolerance in absolute value, declared by manufacturer

$Tol^{(+)} = Tol^{(+)} (\%) * P^{nom} \rightarrow$ Positive tolerance in absolute value, declared by manufacturer

$\varepsilon^{Meas} = P_{max} - P_{nom} \rightarrow$ DPmax which defines the difference between measured values and declared values

$\varepsilon^{Meter} \rightarrow$ Absolute error of the measurement chain (meter + transducers in the point of measure) considering the error % and the declared dgt

(1) OK → Positive response of test also considering the error of measurement chain

(2) OK* → Response of test positive less than the error of measurement chain

(3) NO OK* → Response of test negative less than the error of measurement chain

(4) NO OK → Negative response of test also considering the error of measurement chain

6.3. QUICK CHECK ON PV MODULES AND STRINGS (IVCK)

6.3.1. General information

This function permits to carry out a quick Test of a panel/string just measuring open circuit voltage and short circuit current in compliance with IEC/EN62446. Consequently both irradiance and temperature module values can be measured (using corresponding probes).

Irradiance measurement can be executed only adopting one of the following modes:

- Irradiance sensor directly connected to I-V400w, I-V500w , SOLAR I-Vw or SOLAR I-Ve
- Irradiance sensor connected to SOLAR-02 through RF to I-V400w, I-V500w , SOLAR I-Vw or SOLAR I-Ve

Irradiance measurements are always effected in real time, it is impossible to start a “remote” recording of irradiance values through SOLAR-02

If minimum IV irradiance threshold is set (see § 5.1.5):

- = 0 → the instrument does not control the presence of cell, irradiance changes, number of modules and does not display error messages should it be impossible to calculate Voc and Isc values transposed to Voc and Isc under STC. This mode is suitable to effect a test session on a considerable number of strings as quickly as possible.
- > 0 (suggested > 700) → the instrument carries out all tests provided for I-V, manages all conditions and error messages for I-V test (wrong num. Mod., Temp. out of range, cell presence, Min Irr, etc..) and calculates values of Voc and Isc under STC. This mode is recommended whenever thorough tests are to be effected on modules/strings under test.

In general the result page will include:

- Description of the module
- Irradiance and temperature values (if available)
- Average values of Voc and Isc calculated as average of the corresponding values under OPC on the last 10 tests saved into memory. If the number of tests is < 10 the average is calculated on the number of available tests. The first test will display dashes in the field “average values” as there are no previous tests on which average can be calculated.
- The values of Voc and Isc measured under OPC as well as any partial outcome (the latter available only if STC values are not available) obtained through comparison with average values.
- The values of Voc and Isc calculated under STC (if available) and any partial outcome obtained comparing the values calculated under STC with the nominal ones (inserted in DB modules).
- The overall test outcome (OK(NO). The overall result will be calculated based on the partial results.
 - Based on partial outcome under STC (if these are available)
 - Based on partial outcome under OPC (if STC values are not available)

The instrument will not display any overall outcome if no partial result is available.

In case of negative outcome it is advisable to effect measurement of I-V feature (see § 6.2) in order to thoroughly analysis of the module/string under test.

6.3.2. Preliminary settings

1. Turn the instrument on by pressing **ON/OFF** key.
2. Press **ESC/MENU** to display the main menu.
3. Select "**I-V**" and press **ENTER** to enter the FV module performance measurement section.
4. In case the current mode is not IVCK, press **ENTER**, select "**Measurement** ▶" by means of arrow keys (▲, ▼). Use the arrow key ▶ to enter the internal submenu, select "**IV Check**" and confirm by **ENTER** to start up the initial screen of rapid test **IVCK**.

15/05/10 15:34:26	
Vdc =	0.0 V
Irr =	0 W/m²
Tc =	- - - °C
Module: SUNPOWER 210	
	I-V Test
Set	Rs Test
Mea	I-V Fast Check
Select	I-V

5. Press **ENTER**, select "**Settings**" and confirm by pressing **ENTER** again to enter the following screen where it is possible to set module type and number of modules making the string under test.

15/05/10 15:34:26	
Module:	SUNPWR210
Irr	980W/m ²
Tc (AUTO)	49°C
VocMed@OPC	647V
IscMed@OPC	5.43A
Voc@OPC	646V
Isc@OPC	---A
Avg Reset	V
Settings	A
Meas Type ▶	
Select	IVCK

6. Use the arrow keys (◀, ▶) to select the module type among the ones stored inside the instrument's database (see § 5.3.1)
7. Use the arrow keys (▲, ▼), select "Mod. per Str" and use the arrow keys (◀, ▶) to enter the number of modules for the string under test. The maximum number of modules to be set is **50**
8. Use the arrow keys (▲, ▼), select "Temp" and use the arrow keys (◀, ▶) to select the measurement type of the module temperature among the modes:

15/05/10 15:34:26	
Tip : ◀ SUNPOWER 210 ▶	
Mod. x Str :	15
Temp :	Manual
Value :	51°C
Tol Voc :	3% (+4%)
Tol Isc :	3% (+4%)
Start :	Manual
Voc =	64.7 %
Isc =	6.20 %
	SETTING

- "**Auto**" → automatic measurement carried out according to the measured open circuit voltage value of modules (**recommended method**)
 - **Manual** → entering the value of module temperature in the corresponding field "**Value**"
 - **Aux** → temperature measurement with probe
9. Use the arrow keys (▲, ▼), select "Tol Voc" and "Tol Isc" then use the arrow keys (◀, ▶) to set the tolerance values for open circuit voltage (Voc) and short circuit current (Isc) provided by the module manufacturer (values allowed: +0% .. +25%). Please note that the instrument's uncertainty is indicated in brackets beside the above mentioned values and it will be added to the value entered to get the outcome (OK/NO).
 10. By means of arrow keys (▲, ▼) select the "Start" item and by means of arrow keys (◀, ▶) choose the type of measurement activation between the modes listed:
 - "**Auto**" → test automatically activated by the instrument with stable values of voltage among inputs for at least 1s and with values within range (see § 10.2)
 - "**Manual**" → test activated from the user by press of **GO/STOP** key
 11. Press **SAVE** to store the measurements effected or **ESC/MENU** to quit without saving.

6.3.3. Fast check IVCK without irradiance measurement



CAUTION

- The maximum voltage among inputs P1, P2, C1 and C2 is 1000V DC (for I-V400w and SOLAR I-Vw) or 1500V (for I-V500w and SOLAR I-Ve). Do not measure voltages exceeding the limits expressed in § 10.2
- The maximum current allowable for the instrument is 15A. Do not effect tests in parallel on FV module strings.
- Never effect tests on modules or FV strings connected to DC/AC converter.

1. Turn on the instrument pressing **ON/OFF**
2. Check that remote unit SOLAR-02 is not selected (see § 5.1.4– setting NO)
3. Check that the value of minimum irradiance set in the section “Irradiance” (see §5.1.5) is equal to **0**
4. Go back to main MENU and select “**I-V**”
5. Select “**I-V**” and press **ENTER** to enter the section of FV module performance measurement. Generally when selecting **I-V** on general menu the instrument automatically shows the last mode under use (I-V or IVCK).
6. In case the current mode is not IVCK, press **ENTER**, select “**Measurement** ▶” by means of arrow keys (▲,▼). Use the arrow key ▶ to enter the internal submenu, select “**IV Check**” and confirm pressing **ENTER** to start up the initial screen of fast check **IVCK**.

15/05/10 15:34:26	
Vdc =	0.0 V
Irr =	0 W/m ²
Tc =	- - - °C
Module: SUNPOWER 210	
	I-V Test
Imp	IV Check
Mis	
Selection	I-V

7. Check the preliminary settings based on descriptions of § 6.3.2
8. Connect the instrument to the module/string under test as shown in the following picture. In particular connect the negative pole of the module/string to terminals P1, C1 and it positive pole to terminals P2, C2. In **Auto** activation mode is recommended the use of KITKELVIN optional accessory

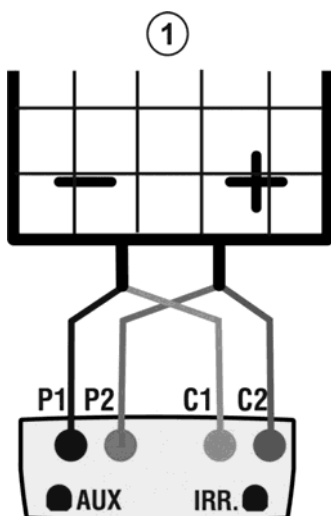

CAPTION:

- P1: Black cable
- P2: Blue cable
- C1: Green cable
- C2: Red cable

1: Module or FV string

Fig. 10: Connection to module/FV string for IVCK tests without irradiance measurement

9. The initial screen under **IVCK** mode displays the values of:

- Module under use
- The average values of Voc and Isc under OPC conditions.
- The value of Voc measured under OPC conditions

15/05/10 15:34:26	
Module:	SUNPWR210
Irr.	---W/m ²
Tc (AUTO)	---°C
VocMed@OPC	647V
IscMed@OPC	5.43A
Voc@OPC	646V
Isc@OPC	---A
Voc@STC	---V
Isc@STC	---A
Selection	IVCK



CAUTION

When pressing the **GO/STOP** key the instrument can provide different error messages (see §6.3) and, as direct consequence, not carry out the test. Check and eliminate, if possible, causes of the problems before continuing the test.

10. Press **GO/STOP** (in Manual activation mode) to start the test. In case of no error conditions, the instrument displays the screen with results as shown sideways. It displays as follows:

- The module under use
- The average values of Voc and Isc under OPC conditions
- The values of Voc and Isc measured under OPC and relative partial outcome resulting after comparing the average values. In general:

15/05/10 15:34:26	
Module:	SUNPWR210
Irr	---W/m ²
Tc (AUTO)	--°C
VocMed@OPC	647V
IscMed@OPC	5.43A
Voc@OPC	647V OK
Isc@OPC	5.35A OK
Voc@STC	---V
Isc@STC	---A
OUTCOME: OK	
Selection	IVCK

$$\text{Outcome } Voc_{@OPC} = OK \quad \text{if} \quad 100 \times \left| \frac{VocAvg_{@OPC} - Voc_{@OPC}}{VocAvg_{@OPC}} \right| \leq (\text{Tol Voc} + 4\%)$$

$$\text{Outcome } Isc_{@OPC} = OK \quad \text{if} \quad 100 \times \left| \frac{IsAvg_{@OPC} - Isc_{@OPC}}{IsAvg_{@OPC}} \right| \leq (\text{Tol Isc} + 4\%)$$

- The overall value of outcome:
 - OK: if all results under OPC are OK,
 - NO if one of the results under OPC is NO

11. Press **SAVE** to store the test result into the instrument's memory (see §7.2) or press **ESC/MENU** to quit without saving and go back to main measurement screen

12. The "Auto" activation mode require to disconnect and reconnect the test leads in order to start automatically a new measurement

NOTES on displayed AVERAGE VALUES

The average values of Voc and Isc are displayed on the outcome page. Such values include the average values of Voc and Isc under OPC conditions calculated as mean of the last 10 tests previously saved. If the user effected and saved a number of tests <10 or he reset the average values (see 6.3.5) the average value displayed during test N+1 will be calculated on N available values.

6.3.4. Fast check IVCK with irradiance measurement

CAUTION



- The maximum voltage among inputs P1, P2, C1 and C2 is 1000V DC (for I-V400w and SOLAR I-Vw) or 1500V (for I-V500w and SOLAR I-Ve). Do not measure voltages exceeding the limits expressed in § 10.2
- The maximum current allowable for the instrument is 15A. Do not effect tests in parallel on FV module strings.
- Never effect tests on modules or FV strings connected to DC/AC converter.

1. Turn on the instrument pressing **ON/OFF**
2. Irradiance measurement can be carried out just through the following modes:
 - Measurement through reference cell directly connected to I-V400w, I-V500w, SOLAR I-Vw or SOLAR I-Ve
 - Measurement through reference cell connected to SOLAR-02 under RF to I-V400w, I-V500w, SOLAR I-Vw or SOLAR I-Ve
 Check that the remote unit SOLAR-02 setting is consistent with the type of measurement to be effected (see §5.1.4).
3. Check the minimum irradiance value set in the “irradiance” section (see § 5.1.5).
4. Go back to main MENU and select “I-V”
5. Select “I-V” and press **ENTER** to enter the FV module performance measurement section. Generally when selecting I-V on general menu the instrument automatically shows the last mode under use (I-V or IVCK).
6. In case the current mode is not IVCK, press **ENTER**, select “**Measurement** ▶” by means of arrow keys (▲, ▼). Use the arrow key ▶ to enter the internal submenu, select “**IV Check**” and confirm pressing **ENTER** to start up the initial screen of fast check **IVCK**

15/05/10 15:34:26	
Vdc	= 0.0 V
Irr	= 0 W/m ²
Tc	= - - - °C
Module: SUNPOWER 210	
	I-V Test
Imp	IV Check
Mis	
Selezione	I-V

7. Check the preliminary settings based on descriptions of § 6.3.2
8. Connect the instrument to the module/string under test as shown in the following picture. In particular connect the negative pole of the module/string to terminals P1, C1 and it positive pole to terminals P2, C2. In **Auto** activation mode is recommended the use of KITKELVIN optional accessory

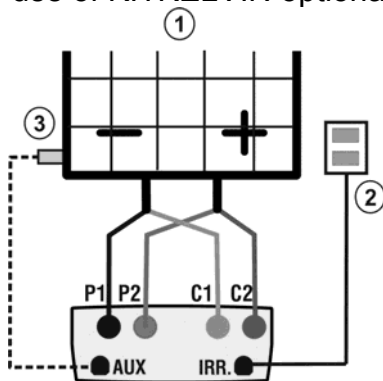

Fig. 14: Instrument's connection for IVCK tests with direct measurement of Irrad/Temp

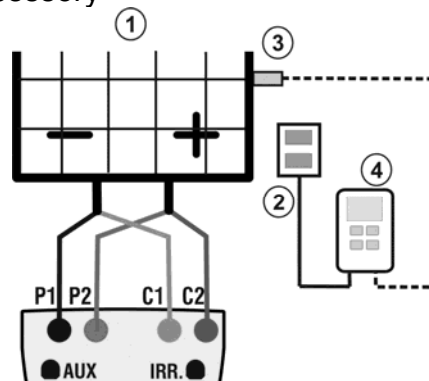

Fig. 15: Instrument's connection for IVCK tests with measurement of Irrad/Temp through SOLAR-02

Caption:

- P1: Black cable
- P2: Blue cable
- C1: Green cable
- C2: Red cable

- 1: Module or FV string
- 2: Reference cell
- 3: Temp probe (if required)
- 4 Remote unit SOLAR-02

9. Connect irradiance probes and temperature probe (if necessary) according to previous pictures and to effected settings (see § 6.3.2).

10. In the initial screen of **IVCK** mode the following values are displayed:

- Module under use
- Irradiance (through direct measurement or SOLAR_02 under RF connection)

➤ The temperature value (if mode MAN or AUX) and corresponding measurement mode. If mode AUTO →”--“

➤ The average values of Voc and Isc under OPC conditions

The following values acquired in real time are also displayed:

- Open circuit voltage
- Any symbol of RF connection with SOLAR-02

15/05/10	
15:34:26	
Module:	SUNPWR210
Irr.	980W/m ²
Tc (AUTO)	--°C
VocMed@OPC	647 V
IscMed@OPC	5.43A
Voc@OPC	646V
Isc@OPC	---A
Voc@STC	---V
Isc@STC	---A
Selection	IVCK



CAUTION

When pressing the **GO/STOP** key the instrument can provide different error messages (see §6.3) and, as direct consequence, not carry out the test. Check and eliminate, if possible, causes of the problems before continuing the test.

11. Press **GO/STOP** (in Manual activation mode) to start up the test. In case of no error conditions, the instrument displays the screen with the following results:

- The module under use
- The irradiance value
- The cell temperature value
- The average values of Voc and Isc under OPC
- The values of Voc and Isc measured under OPC
- The values of Voc and Isc measured under STC and relative partial outcome resulting after comparing the rated values.

In general:

15/05/10 15:34:26	
Module: SUNPWR210	
Irr	932W/m ²
Tc (AUTO)	57°C
VocMed@OPC	647V
IscMed@OPC	5.43A
Voc@OPC	647V
Isc@OPC	5.35A
Voc@STC	787V OK
Isc@STC	5.72 A OK
OUTCOME: OK	
Selection	IVCK

$$Outcome Voc_{@STC} = OK \quad \text{if} \quad 100 \times \left| \frac{VocNom_{@STC} - Voc_{@STC}}{VocNom_{@STC}} \right| \leq (Tol Voc + 4\%)$$

$$Outcome Isc_{@STC} = OK \quad \text{if} \quad 100 \times \left| \frac{IscNom_{@STC} - Isc_{@STC}}{IscNom_{@STC}} \right| \leq (Tol Isc + 4\%)$$

The rated values of Voc and Isc are the values of the DB built-in modules (see §5.3)

- The overall value of outcome:
 - OK: if all results under STC are OK,
 - NO if one of the results under STC is NO

12. Press **SAVE** to store the test result into the instrument's memory (see §7.2) or press **ESC/MENU** to quit without saving and go back to main measurement screen

13. The “**Auto**” activation mode require to disconnect and reconnect the test leads in order to start automatically a new measurement

6.3.5. Reset Media

If irradiance values are measured the instrument provides an outcome comparing the measured values with the average values calculated according to previously saved measurements.

Therefore in this case the average values calculated by the instrument play an important role.

In case you start a new set of measurements with significant variations in irradiance and temperature it is advisable to set the reference average values to zero in order to recalculate based on new measurements.

To reset the average values keep to the following steps:

1. Under mode IVCK, press **ENTER** key, select “**Reset Media**” and confirm by pressing **ENTER** to zero the average values calculated till then.

15/05/10 15:34:26	
Module:	SUNPWR210
Irr	980W/m2
Tc (AUTO)	49°C
VocMed@OPC	---V
IscMed@OPC	---A
Voc@OPC	646V
Isc@OPC	---A
Reset Media	V
Settings	A
Measurement ▶	
Selection	IVCK

The average values are automatically reset even **modifying and saving** one of the following parameters:

- FV module type
- Number of modules per string

The average values are not reset if the operator changes working mode (for example he goes to the overall detection of the I-V curve to effect string analysis in deep) and go back to this mode.

6.4. LIST OF DISPLAY MESSAGES

MESSAGE	DESCRIPTION
Voltage too low	Check the voltage between C1 and C2 input terminals
Vin > 1000	DC output voltage from module/string > 1000V (I-V400w, SOLAR I-Vw)
Irradiance too low	Irradiance value lower than threshold limit
NTC Error	Internal NTC damaged. Contact service dpt
Please wait for cooling...	Instrument overheated. Wait before starting the tests again
Memory full	Internal memory full. Download data to PC
Pulse width too long	Anomalous condition. Repeat test with more modules
Current too low	Measured current lower than the minimum detectable
Vdc wrong connection	Check the voltage between C1 and C2 input terminals
Negative voltage	Check the polarity of input terminals
Data base full	The number of modules defined is > 30
Data @ STC unavailable	The meter does not calculate the date at STC conditions
Irradiance too high	Irradiance value higher than the maximum range
Data unavailable	Generic error. Repeat the test
Isc too high	Output current higher than maximum range
Wrong date	Set a correct date/hour on meter
Error 1/2/3/4/5: contact Assistance	Contact service dpt
Error EEPROM : contact Assistance	Contact service dpt
Error FLASH : contact Assistance	Contact service dpt
Error RTC : contact Assistance	Contact service dpt
Battery low	Low battery indication. Fit new batteries inside meter
Error: Vmpp >= Voc	Check the settings of module inside DB
Error: Impp >= Isc	Check the settings of module inside DB
Error: Vmpp * Impp >= Pmax	Check the settings of module inside DB
Error: alpha too high	Check the settings of module inside DB
Error: beta too high	Check the settings of module inside DB
Error: Toll too high	Check the settings of module inside DB
Error: gamma too high	Check the settings of module inside DB
Module already present	Name of module just used inside DB
Delta-Irrad. too high. Retry	Unstable condition on irradiance. Repeat the test
Voltage not steady	Anomalous condition. Repeat test with more modules
Unsteady Current	Difference between 2 consec. Instant. values of current is > 0.13A
Firmware mismatch	Problem with internal FW. Contact service dpt
Ref. Cell temp over range	Temperature measured by reference cell is too high
PV module temp over range	Temperature of module over maximum range
Voc out of range. Continue (ENTER/ESC)?	Voc measured not compliance with the set number of modules (check also the Voc and Beta parameters values in the module's data sheet)
Ref. Cell temp not detected (ENTER/ESC)	Measure on the cell of module not performed
Error during memory writing	Problem with the access to internal memory
Error Radio: contact Assistance	Contact service dpt
Error Radio transmission	Contact service dpt
Error during download	Contact service dpt
Recording downloaded	Recording corrected downloaded on the instrument
Radio connection activated	Corrected RF connection with remote unit SOLAR-02
Wait data analysis	Download data from SOLAR-02 and wait for response
Unable execute analysis	Problem on downloaded data from SOLAR-02. Verify settings
I < Lim	Output current lower that the minimum measurable
CAUTION: internal short	Contact service dpt
Remote unit not detected Enter/Esc	Unit SOLAR-02 do not RF connected to the instrument
Rem. Unit in rec	Unit SOLAR-02 in recording parameters Irr/Temp
STC Data available after Stop rec.	Stop the recording to obtain STC data
STC Data available in MEM	Data STC condition save on memory
Verify connect. P1	Check the proper insertion of test cable in the input P1
Error in data download from SOLAR-02	SOLAR I-Vw/SOLAR I-Ve used with MPP300. Download error from SOLAR-02.
SOLAR-02 not detected. Stop Rec.?	SOLAR I-Vw or SOLAR I-Ve used with MPP300. SOLAR-02 not detected when stop Rec.
MPP300 not detected	SOLAR I-Vw or SOLAR I-Ve set for use together with MPP300. MPP300 not detected
SOLAR-02 not detected.	SOLAR I-Vw or SOLAR I-Ve set for use together with MPP300. SOLAR-02 not detected.
MPP300: negative AC power	MPP300 has detected negative AC powers.
MPP300: inverted AC and DC voltages	MPP300 has detected inverted AC and DC voltages
No power supply to MPP. Continue? Enter/Esc	MPP300 has not detected the presence of the external power supply.
C1 C2 not connected	Check the connections of the instrument to module/string on test
C1 C2 not connected or fuse blown	Check the connections of the instrument and repeat the test. If there is problem again contact service dpt
Fuse blown	
Incorrect language version	Update the language file of the instrument
C1/C2: neg. voltage.	Check the polarity of the connections

7. STORING DATA

The meter allows storing 99 results of PV checks (only SOLAR I-Vw or SOLAR I-Ve) and 249 tests of I-V curve in its internal memory. In the PV check operation it's also possible to save the instantaneous values at display. The saved data can be recalled at display and deleted in each moment, and can be associated (for I-V curve test) to reference numerical markers relevant to the installation name, the PV string and the PV module (max 255 markers).

7.1. SAVING TEST RESULTS OF PV CHECKS (SOLAR I-VW OR SOLAR I-VE)

1. Press **SAVE** key with a measured result shown at display or for saving the instantaneous values. The right screen with a virtual keyboard is displayed by the meter
2. Use the arrow keys (**▲**, **▼**) and (**◀**, **▶**) to fit a short description (max 12 chars) relative to the PV check
3. Press **SAVE** key to store the result of test or **ESC/MENU** key to exit without saving

15/05/10 15:34:26		
PRp	0.851	
Irr	827	W/m ²
Pnom	3.500	kW
Tc	45	°C
Te	30	°C
KEYBOARD		
ABCDEFGHI		
A B C D E F G H I	J K L M N O P	
Q R S T U V W X Y Z	- + 0 1 2 3	
4 5 6 7 8 9	SPACE	DEL
SAVE for store data		

7.2. SAVING TEST RESULTS OF I-V CURVE TEST

1. Press **SAVE** key with a measured result shown at display. The following screen is displayed where the herewith items are shown:
 - The first memory location available ("Measurement")
 - The numerical marker "Installation"
 - The numerical marker "String"
 - The numerical marker "Module"
 - The field "Comment" where the operator can include a short description (max 14 char) by using virtual keyboard

15/05/10 15:34:26		
Measurement: 007		
Installation: ◀ 010 ▶		
String: 009		
Module: 004		
Comment:		
KEYBOARD		
ABCDEFGHI		
A B C D E F G H I	J K L M N O P	
Q R S T U V W X Y Z	- + 0 1 2 3	
4 5 6 7 8 9	SPACE	DEL
SAVE for store data		
Comment		MEM - IV

2. Use the arrow keys (**▲**, **▼**) to select the items and (**◀**, **▶**) to set the numeric value of the markers and to use the virtual keyboard. "Comments" field modifications are possible only by changing the number of the "Installation" marker inserting one among the available markers
3. Press **ENTER** to digit any character of the desired name
4. Press **SAVE** key to store the result of test or **ESC/MENU** key to exit without saving.

7.3. MANAGING THE RESULTS

7.3.1. Recall data of PV checks at display (SOLAR I-Vw or SOLAR I-Ve)

1. Press **ESC/MENU** key to back to the main menu, select the “**MEM**” item and confirm with **ENTER** to access inside the section of saved data
2. Using arrows keys (▲,▼) and the arrow key ► select the item “**Recall**”, the item “**Yield Test**” and confirm with **ENTER** for the visualization of PV checks results only
3. Using arrow key ► the herewith labels can be displayed:
 - **TYPE** → means the type of saved data: “**REC**” for a complete PV check, “***REC**” when the values of irradiance/temperature measured by SOLAR-02 are not available for the meter and “**IST**” for the saving of instantaneous values at display
 - **DATA** → means the date/hour of saved data on meter
 - **Comments** → means the description gives by the user during the data saved operation
4. Select the “**IST**” data, the item “**View**” and confirm with **ENTER**. The herewith screen is displayed:

15/05/10 15:34:26	
MEM	TYPE
001	IST 08/04/2010
002	REC 13/05/2010
003	*REC 14/05/2010
Yield Test	
View	I-V Test
Recall	
Delete	►
Select	MEM - EFF

5. Press the arrow keys (▲,▼) to access to the two available screens
6. Press **ESC/MENU** to back to previous screen
7. Select the “**REC**” data, the item “**View**” and confirm with **ENTER**. The herewith screen is displayed:

15/05/10 15:35:00	
▲	
Pdc	3.125 kW
Vdc	389 V
Idc	8.01 A
ndc	0.88 °C
Pac	3.012 kW
Vac	231 V
Iac	13.03 A
nac	0.96
Analysis results	
Select	EFF

8. Press the arrow keys (▲,▼) to access to the two available screens
9. The final values of PV check relative to the maximum efficiency condition detected are displayed
10. Press **ESC/MENU** to back to previous screen
11. Selecting the “***REC**” data, the item “**View**” and confirm with **ENTER** the message “Unable to execute analysis” is displayed due to the missed of irradiance/temperature values recorded by SOLAR-02. **The partial values of this measurement are only visible after downloading the data onto PC (see § 8)**

15/05/10 15:35:00	
▲	
Pdc	3.125 kW
Vdc	389 V
Idc	8.01 A
ndc	0.88 °C
Pac	3.012 kW
Vac	231 V
Iac	13.03 A
nac	0.96
Select	EFF

7.3.2. Recall data of I-V curve tests at display

1. Press **ESC/MENU** key to back to the main menu, select the “**MEM**” item and confirm with **ENTER** to access inside the section of saved data
2. Using arrows keys (▲,▼) and the arrow key ► select the item “**Recall**”, the item “**I-V Test**” and confirm with **ENTER** for the visualization of I-C curve results only
3. The “**DATA**” label means the date/hour of saved data on meter

15/05/10 15:34:26	
MEM	DATA
001	08/04/2010 10:38
002	13/04/2010 12:15
Yield Test	
Vie	I-V Test
Recall	
Delete ►	
Select	MEM I - V

4. Use arrow key ► to select the “Comments” label
5. The description gives by the user during the data saved operation (see § 7.2) is displayed
6. The symbol “*” near the number of measure means that the meter have performed the I-V curve test with recording of irradiance/temperature values by use of remote unit SOLAR-02, but this values did not transferred or are not available. **For this measurements the translated STC values won't be available**

15/05/10 15:34:26	
MEM	Comments
001	MODULE # 1
002*	MODULE # 2
Select	MEM I - V

7. By means of the arrow key ►, select the “parameters” label.
8. The markers relevant to Installation, String and Module selected by the user during the saving procedure (§ 7.2) are shown on the display.
9. Press **ESC/MENU** to exit the screen and to go back to the main menu.

15/05/10 15:34:26			
MEM	IMP	STR	MOD
001	001	001	001
002	001	001	002
Select	MEM - IV		

7.3.2.1. View data – Numerical screens

1. Select a row corresponding to a saved result and press **ENTER** to access the § for the display of stored data. The herewith screen shows a list of saved tests.
2. Select the “**View**” item and press **ENTER** to open the section of data visualization in the herewith modes:
 - Numeric screens of parameters measured at the STC conditions and at the operative conditions (OPC)
 - Graphic screens relative to the I-V curves saved at STC and OPC conditions

15/05/10 15:34:26			
MEM	INS	STR	MOD
001	001	001	001
002	001	001	002
View			
Delete			▶
Select		MEM – IV	

3. The first screen shows the values of measured parameters, referred to 1 module, translated to the standard conditions (STC) according to § 6.2.3
4. Press arrow key ▶, select by means of arrow keys (▲, ▼) the option “**OPC – Avg**” and press **ENTER**.

15/05/10 15:34:26		
Voc	48.0	V
Vmpp	39.8	V
Impp	5.24	A
Isc	5.60	A
Pmax	208	W
FF	0.78	%
DPmax	STC	
	OPC – Avg	
Data	OPC	
I-V Graph	▶	
PWR Graph	▶ - OK	
Select	I – V	

5. The meter shows the values measured on a string at the real operating conditions (OPC). The values are **averaged on a single module** (corresponding to the total values should the string be made of a single module).
6. Press arrow key ▶ in the first screen, select the option “**OPC**” by means of arrow keys (▲, ▼) and press **ENTER**.

15/05/10 15:34:26		
Voc	46.9	V
Vmpp	39.0	V
Impp	4.85	A
Isc	5.22	A
Pmax	189	W
FF	0.77	%
Irr	927	W/m ²
Tc	25.1	°C
Results @ OPC – Avg		
Select	I – V	

7. The meter shows the total values measured at the real operating conditions (OPC) relative to the string under test.
8. Press **ESC/MENU** key to exit and go back to the previous screen.

15/05/10 15:34:26		
Voc	46.9	V
Vmpp	39.0	V
Impp	4.85	A
Isc	5.22	A
Pmax	189	W
FF	0.77	%
Irr	927	W/m ²
Tc	25.1	°C
Results @ OPC		
Select	I – V	

7.3.2.2. View data – Graphic screens of I-V curve

1. With screen of numerical values relative to standard conditions (STC) select the item “**I-V Graph**” by means of arrow key ▼ and press **ENTER** or the arrow key ►.
2. Select the “**STC**” option and press **ENTER**.
3. The herewith screen is shown by the meter.

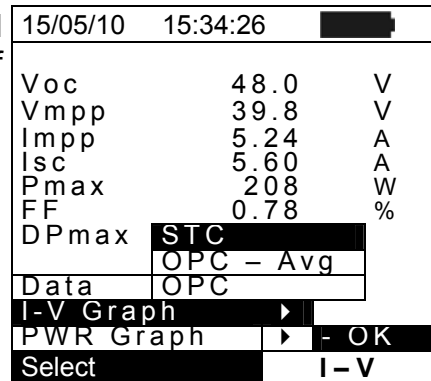

4. The graph is the I-V curve relative to the object under test translated to the standard conditions (STC) and referred to 1 module.
5. Press **ESC/MENU** key to exit the screen and to go back to the memory section.

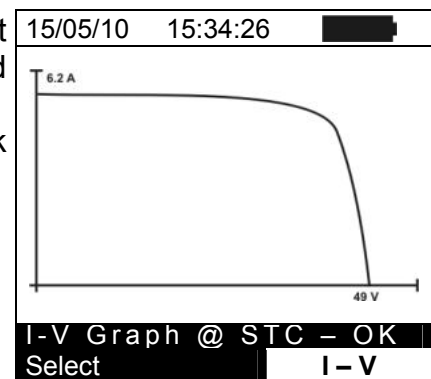

6. With screen of numerical values measured by meter select the item “**I-V Graph**” by means of arrow key ▼ and press **ENTER** or the arrow key ►.
7. Select the option “**OPC - Avg**” and press **ENTER**. The I-V curve graph of a string measured at the real operative conditions (OPC) and displayed by the meter is **averaged on a single module**.
8. Press **ESC/MENU** key to exit the screen and to go back to the memory section

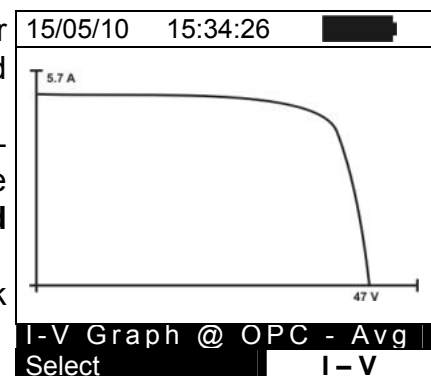

9. With screen of numerical values measured by meter select the item “**IV Graph**” by means of arrow key ▼ and press **ENTER** or the arrow key ►.
10. Select the option “**OPC**” and press **ENTER**. The I-V curve graph measured at the real operative conditions (OPC) and displayed by the meter corresponds to the **total value relative to the string under test**.
11. Press **ESC/MENU** key to exit from screen and back to the memory §

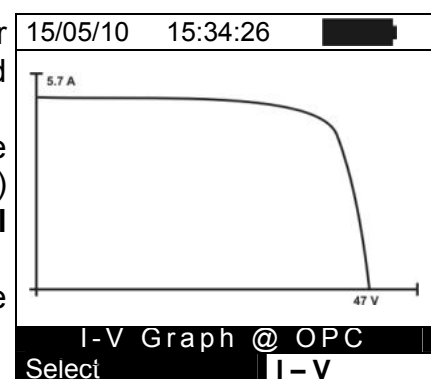

7.3.2.3. View data – Graphic screens of power

1. With screen of numerical values measured by the meter select the item “**PWR Graph**” by means of arrow key ▼ and press **ENTER** or the arrow key ►.
2. Select the option “**STC**” and press **ENTER**.
3. The herewith screen is shown by the meter.

15/05/10 15:34:26		
Voc	48.0	V
Vmpp	39.8	V
Imp	5.24	A
Isc	5.60	A
Pmax	208	W
FF	0.78	%
DPmax	0.5	%
Data	STC	
I-V G	OPV - Avg	
PWR	OPC	
Select		I - V

4. The graph shows values of output power from module/string translated to the standard conditions (STC).
5. Press **ESC/MENU** key to exit the screen and to go back to the memory §.

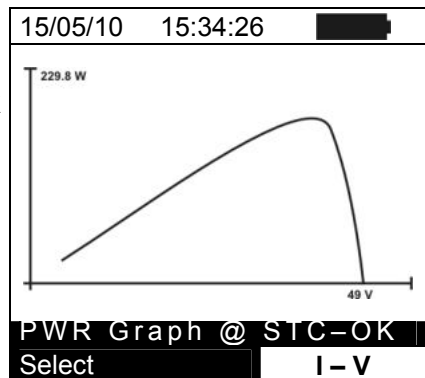

6. With screen of numerical values measured by meter, select the item “**PWR Graph**” by means of arrow key ▼ and press **ENTER** or the arrow key ►.
7. Select the option “**OPC - Avg**” and press **ENTER**. The meter shows the graph of **output power from a single module of a string** measured at the real operative conditions (OPC).
8. Press **ESC/MENU** key to exit the screen and to go back to the memory §.

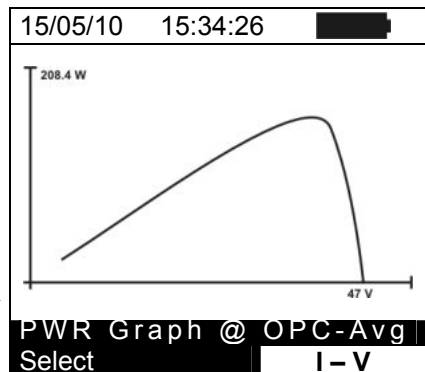

9. With screen of numerical values measured by the meter select the item “**PWR Graph**” by means of arrow key ▼ and press **ENTER** or the arrow key ►.
10. Select the option “**OPC**” and press **ENTER**. The meter shows the graph of **total output power relevant to the string under test** measured at the real operative conditions (OPC).
11. Press **ESC/MENU** key to exit the screen and to go back to the memory §.

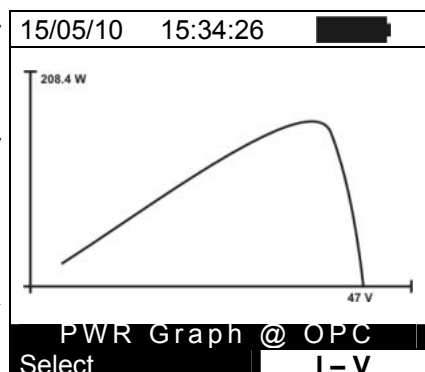

7.3.3. Delete data

1. Press **ENTER** key in the memory § to show the submenu
2. Select the “Delete” item and press the arrow key ►. The options below are shown by the meter:
 - **Del. Last** → delete the last measurement saved
 - **Del. All** → delete all data in the memory
3. Select the desired option with arrow keys (▲,▼) and confirm with **ENTER**
4. Press **ESC/MENU** to exit the screen and go back to main menu

15/05/10 15:34:26	
MEM	DATA
001	15/05/10 12:32
View Del. Last	
Delete	Del. All
Select	MEM - IV

8. CONNECTING THE INSTRUMENT TO A PC

8.1. CONNECTING BY OPTICAL/USB CABLE C2006

CAUTION



- The connection between instrument and PC is realized by means C2006 cable.
- In order to transfer the data onto a PC it is necessary to install the management software Topview in advance and the drivers of cable C2006 on the PC itself.
- Before connecting, it is necessary to select the port to be used and the right baud rate (57600 bps) on the PC. To set these parameters, start the **TopView** software and refer to the program's on-line help.
- The selected port must not be engaged by other devices or applications, e.g. a mouse, a modem, etc.
- Optical port emits invisible LED radiations. Do not bring the beam at eye level. Class 1M LED apparatus according to IEC/EN 60825-1

To transfer the saved data to the PC, keep to the following procedure:

1. Switch on the instrument by pressing **ON/OFF** key
2. Connect the instrument to the PC via the provided optical/USB cable **C2006**.
3. Press **ESC/MENU** key to open the main menu.
4. By means of arrow keys (**▲, ▼**) select the item "**PC Connection**" to access the PC mode section and confirm with **ENTER**

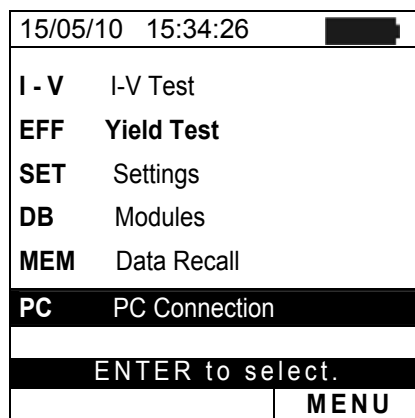

5. The below screen is displayed by the meter:

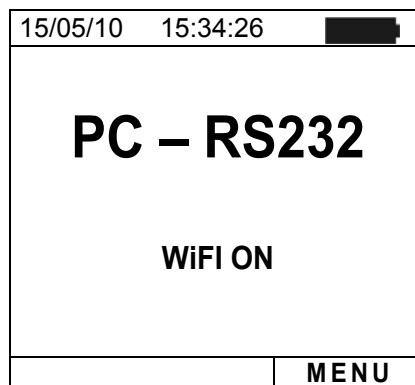

6. Use data management software TopView to transfer the content of the instrument memory to the PC (see on-line help of this software for all details)

8.2. CONNECTING BY WIFI

CAUTION



- The connection between instrument and PC is realized by means of WiFi interface which is normally active on the instrument. The WiFi function is not available if in the initial screen of the instrument (see § 4.4) the “WiFi-OFF” message is displayed
- In order to transfer the data onto a PC it is necessary to install the management software Topview in advance, and WiFi interface shall be available on the PC itself
- Before connecting it is necessary to enable WiFi connection on the instrument as below mentioned, and select/connect the “wireless network” (WiFi) which the instrument makes available
- Before connecting, it is necessary to select the “WiFi” port on the “PC Instrument Connection” of **TopView** software and refer to the program on-line help.

To transfer the saved data to the PC, keep to the following procedure:

1. Switch on the instrument by pressing **ON/OFF** key
2. Press **ESC/MENU** key to open the main menu.
3. By means of arrow keys (**▲, ▼**) select “**PC Connection**” to access the PC mode section and confirm by **ENTER**

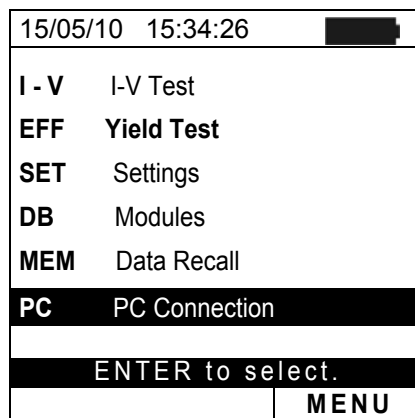

4. The below screen is displayed by the meter:

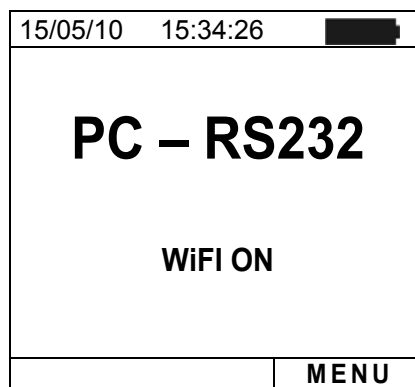

5. Enable the WiFi connection on the PC (if necessary, it is possible to use a WiFi adaptor). Select and connect the WiFi network which the instrument makes available in “Network connection → Wireless networks” section
6. Use data management software TopView to transfer the content of the instrument memory to the PC (see software on-line help for all details)

9. MAINTENANCE

9.1. GENERAL

The instrument you purchased is a precision instrument. When using and storing it, please observe the recommendations listed in this manual in order to prevent any possible damage or danger. Do not use the instrument in environments with high humidity levels or high temperatures. Do not directly expose it to sunlight. Always switch off the instrument after using it. Should the instrument remain unused for a long time, remove batteries in order to prevent liquids from leaking out of them, and the instrument internal circuits from being damaged.

9.2. BATTERY REPLACEMENT

When the low battery symbol "" appears on the LCD display, or if during a test the meter gives the message "low battery", it is necessary to replace the batteries.



CAUTION

This operation must be carried out by skilled technicians only. Before carrying out this operation, make sure that all cables have been removed from the input leads.

1. Switch off the instrument by pressing and holding the **ON/OFF** key.
2. Remove the cables from the input leads.
3. Unscrew the cover fastening screw from the battery compartment and remove it.
4. Remove all the batteries from the battery compartment and replace with new batteries of the same type only (§ 10.4) making sure to respect the indicated polarities.
5. Restore the battery compartment cover into place and fasten it by means of the relevant screw.
6. Do not dispose of the used batteries into the environment. Use relevant containers for disposal.

9.3. INSTRUMENT CLEANING

Use a dry and soft cloth to clean the instrument. Never use wet cloths, solvents, water, etc.

9.4. END OF LIFE



CAUTION: this symbol indicates that the equipment, the batteries and its accessories must be collected separately and disposed of in the right way.

10. TECHNICAL SPECIFICATIONS

10.1. YIELD TEST TECHNICAL FEATURES (SOLAR I-VW, SOLAR I-VE)

Accuracy is calculated as [%reading+(number of dgt) * resolution] at 23°C ± 5°C, <80%HR

VDC Voltage (SOLAR I-Vw)

Range [V]	Resolution [V]	Accuracy
15.0 ÷ 999.9	0.1	±(0.5%rdg + 2dgt)

VDC Voltage (SOLAR I-Ve)

Range [V]	Resolution [V]	Accuracy
15.0 ÷ 99.9	0.1	±(0.5%rdg + 2dgt)
100.0 ÷ 1499.0	0.3	

AC TRMS Voltage

Range [V]	Resolution [V]	Accuracy
50.0 ÷ 265.0	0.1	±(0.5%rdg + 2dgt)

Max crest factor: 1.5

DC Current (by external transducer clamp)

Range [mV]	Resolution [mV]	Accuracy
-1100 ÷ -5	0.1	±(0.5%rdg + 0.6mV)
5 ÷ 1100		

The value of current is ALWAYS displayed with positive sign ; The value of current transduced in voltage less then 5mV is zeroed

AC TRMS Current (by external transducer clamp)

Range [mV]	Resolution [mV]	Accuracy
1 ÷ 1200	0.1	±(0.5%rdg + 0.6mV)

Max crest factor: 2.0 ; The value of current transduced in voltage less then 5mV is zeroed

FS DC and AC clamp [A]	Resolution [A]	Minimum read value [A]	
		DC	AC
1 < FS ≤ 10	0.001	0.05	0.01
10 < FS ≤ 100	0.01	0.5	0.1
100 < FS ≤ 1000	0.1	5A	1

DC Power (V_{mis} > 150V) (SOLAR I-Vw)

FS clamp [A]	Range [W]	Resolution [W]	Accuracy
1 < FS ≤ 10	0.000k ÷ 9.999k	0.001k	±(0.7%rdg + 3dgt) (I _{mis} < 10%FS)
	10.00k ÷ 99.99k	0.01k	
10 < FS ≤ 100	0.000k ÷ 9.999k	0.001k	±(0.7%rdg) (I _{mis} ≥ 10%FS)
	10.00k ÷ 99.99k	0.01k	
100 < FS ≤ 1000	0.00k ÷ 99.99k	0.01k	
	100.0k ÷ 999.9k	0.1k	

V_{mis} = voltage at which power is measured ; I_{mis} = measured current

DC Power (V_{mis} > 150V) (SOLAR I-Ve)

FS clamp [A]	Range [W]	Resolution [W]	Accuracy
1 < FS ≤ 10	0.000k ÷ 9.999k	0.001k	±(0.7%rdg + 3dgt) (I _{mis} < 10%FS)
	10.00k ÷ 99.99k	0.01k	
10 < FS ≤ 100	0.000k ÷ 9.999k	0.001k	±(0.7%rdg) (I _{mis} ≥ 10%FS)
	10.00k ÷ 99.99k	0.01k	
	100.0k ÷ 999.9k	0.1k	
100 < FS ≤ 1000	0.00k ÷ 99.99k	0.01k	±(0.7%rdg) (I _{mis} ≥ 10%FS)
	100.0k ÷ 999.9k	0.1k	
	1000k ÷ 9999k	1k	

V_{mis} = voltage at which power is measured ; I_{mis} = measured current

AC Power ($V_{mis} > 200V$, PF=1) (SOLAR I-Vw)

FS clamp [A]	Range [W]	Resolution [W]	Accuracy
$1 < FS \leq 10$	0.000k ÷ 9.999k	0.001k	$\pm(0.7\%rdg + 3dgt)$ ($I_{mis} < 10\%FS$)
	10.00k ÷ 99.99k	0.01k	
$10 < FS \leq 100$	0.000k ÷ 9.999k	0.001k	$\pm(0.7\%rdg)$ ($I_{mis} \geq 10\%FS$)
	10.00k ÷ 99.99k	0.01k	
$100 < FS \leq 1000$	0.00k ÷ 99.99k	0.01k	
	100.0k ÷ 999.9k	0.1k	

V_{mis} = voltage at which power is measured ; I_{mis} = measured current

AC Power ($V_{mis} > 200V$, PF=1) (SOLAR I-Ve)

FS clamp [A]	Range [W]	Resolution [W]	Accuracy
$1 < FS \leq 10$	0.000k ÷ 9.999k	0.001k	$\pm(0.7\%rdg + 3dgt)$ ($I_{mis} < 10\%FS$)
	10.00k ÷ 99.99k	0.01k	
$10 < FS \leq 100$	0.000k ÷ 9.999k	0.001k	$\pm(0.7\%rdg)$ ($I_{mis} \geq 10\%FS$)
	10.00k ÷ 99.99k	0.01k	
	100.0k ÷ 999.9k	0.1k	
$100 < FS \leq 1000$	0.00k ÷ 99.99k	0.01k	$\pm(0.7\%rdg)$ ($I_{mis} \geq 10\%FS$)
	100.0k ÷ 999.9k	0.1k	
	1000k ÷ 9999k	1k	

V_{mis} = voltage at which power is measured ; I_{mis} = measured current

Frequency

Range [Hz]	Resolution [Hz]	Accuracy
47.5 ÷ 63.0	0.1	$\pm(0.2\%rdg + 1dgt)$

Irradiance (with reference reference cell)

Range [mV]	Resolution [mV]	Accuracy
1.0 ÷ 65.0	0.1	$\pm(1.0\%rdg + 5dgt)$

Temperature (with auxiliary probe)

Range [°C]	Resolution [°C]	Accuracy
-20.0 ÷ 100.0	0.1	$\pm(1.0\%rdg + 1^{\circ}C)$

10.2. I-V TEST TECHNICAL FEATURES (I-V AND IVCK)

I-V, IVCK: DC Voltage @ OPC (SOLAR I-Vw, I-V400w)

Range [V] (*)	Resolution [V]	Uncertainty (*)
5.0 ÷ 999.9	0.1	±(1.0%rdg + 2dgt)

(*) The I-V curve measurement start for VDC > 15V and the accuracy is defined for VDC > 20V

I-V, IVCK: DC Voltage @ OPC (SOLAR I-Ve, I-V500w)

Range [V] (*)	Resolution [V]	Uncertainty (*)
15.0 ÷ 99.9	0.1	±(0.5%rdg + 2dgt)
100.0 ÷ 1499.9	0.3	

(*) The I-V curve measurement start for VDC > 15V and the accuracy is defined for VDC > 20V

I-V: DC Current @ OPC

Range [A]	Resolution [A]	Uncertainty
0.10 ÷ 15.00	0.01	±(1.0%rdg + 2dgt)

(*) Maximum current = 15A for Voc ≤ 1000V, Maximum current = 10A for Voc > 1000V (I-V500w and SOLAR I-Ve)

I-V: DC Power @ OPC (Vmpp > 30V, Impp > 2A)

Range [W] (*)	Resolution [W]	Uncertainty
50 ÷ 99999	1	±(1.0%rdg + 6dgt)

Vmpp = Maximum power voltage, Impp = Maximum Power Current

(*) The value of max measured power is relative to a max FF value of approx. 0.7
 → Pmax= 1000V x 15A x 0.7 = 10500W
 → Pmax= 1500V x 10A x 0.7 = 10500W

I-V, IVCK: DC Voltage @ STC

Range [V]	Resolution [V]	Uncertainty (*, **)
5.0 ÷ 999.9	0.1	±4.0%rdg + 2dgt)

I-V: DC Current @ STC

Range [A]	Resolution [A]	Uncertainty (**)
0.10 ÷ 99.00	0.01	±(4.0% rdg + 2 dgt)

I-V: DC Power @ STC (Vmpp > 30V, Impp > 2A)

Range [W]	Resolution [W]	Global Uncertainty (**)
50 ÷ 99999	1	±(5.0% rdg + 1 dgt)

Vmpp = Maximum power voltage, Impp = Maximum Power Current

(*) Measurements of I-V curve start for VDC > 15V and the accuracy is defined for VDC > 20V

(**) Test conditions:

- > Test cond.: Steady Irrad. ≥ 700W/m², spectrum AM 1.5, solar incidence vs perpendicular. ≤ ± 25°, Cells Temp. [15..65°C]
- > Global accuracy include contribute of solar sensor and its measuring circuit

Irradiance (with reference cell)

Range [mV]	Resolution [mV]	Accuracy
1.0 ÷ 100.0	0.1	±(1.0%rdg + 5dgt)

Temperature (with auxiliary probe)

Range [°C]	Resolution [°C]	Accuracy
-20.0 ÷ 100.0	0.1	±(1.0%rdg + 1°C)

10.3. SAFETY SPECIFICATIONS

10.3.1. General

Instrument safety:	IEC/EN61010-1
EMC:	IEC/EN61326-1
Technical literature:	IEC/EN61187
Accessory safety:	IEC / EN61010-031
Measurements:	IEC/EN60891 (I-V curve test) IEC/EN 60904-5 (Temperature measurement)
Insulation:	double insulation
Pollution level:	2
Category of measure:	CAT II 1000V DC, CAT III 300V to ground Max 1000V among inputs P1, P2, C1, C2 (SOLAR I-Vw, I-V400w) Max 1500V among inputs P1, P2, C1, C2 (SOLAR I-Ve, I-V500w)

10.4. GENERAL CHARACTERISTICS

Display and memory

Type of display:	LCD custom, 128x128 pxl, backlighted
Memory capacity:	256kbytes
Saved data:	99 yield tests (SOLAR I-Vw/I-Ve); 249 I-V, 999 IVCK
PC interface:	optical/USB and WiFi

RF module specifications

Frequency range:	2.400 ÷ 2.4835GHz
R&TTE category:	Class 1
Max transmission power:	30 μ W
Max distance of RF connection	1m

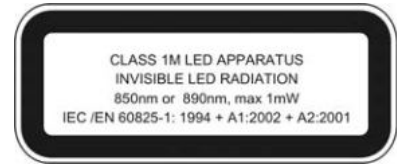

PV Yield Test (SOLAR I-Vw or SOLAR I-Ve)

Integration period (IP):	5, 10, 30, 60, 120, 300, 600, 900, 1800, 3600s
Memory autonomy SOLAR-02:	approx 1.5 hours (@ PI = 5s) approx 8 days (@ PI = 600s)
Max distance RF connection:	1m (3 ft)
Memory of SOLAR-02 - MPP300:	approx. 1.5 hours (@ PI = 5s) approx. 8 days (@ PI = 600s)

Power supply

Battery type:	6 x 1.5 V alkaline type AA LR06
Consumption:	1W
Low battery indication:	symbol "  " is displayed
Battery life:	approx 120 hours (PV Yield test) >249 I-V curve test, 999 IVCK test
Auto power off:	after 5 minutes of idleness

Mechanical data

Dimensions (L x W xH):	235 x 165 x 75mm ; 9 x 6 x 3in
Weight (batteries included):	1.2kg (42 ounces)

10.5. ENVIRONMENT CONDITIONS

Reference temperature:	23° ± 5°C (73°F ± 41°F)
Working temperature:	0 ÷ 40°C (32°F ÷ 104°F)
Relative humidity allowed:	<80%RH
Storage temperature:	-10 ÷ 60°C (14°F ÷ 140°F)
Storage humidity:	<80%RH
Max height of use:	2000m (6562 ft) (*)



CAUTION

(*) Information about the use of meter at altitude from 2000 to 5000m

As for voltage inputs P1, P2, C1, C2 the instrument is to be considered downgraded to overvoltage category CAT I 1000V DC and CAT II 300V to ground, max 1000V among inputs (for SOLAR I-Vw and I-V400w) and max 1500V (for SOLAR I-Ve and I-V500w). Markings and symbols indicated on the instrument are to be considered valid when using it at altitude lower than 2000m

This instrument complies with the prescriptions of the European directive on low voltage 2014/35/EU (LVD) and EMC 2014/30/EU

This instrument satisfies the requirements of 2011/65/EU (RoHS) directive and 2012/19/EU (WEEE) directive

10.6. ACCESSORIES

See only the standard and optional accessory indicated in the enclosed packing list

11. APPENDIX

11.1. TESTING PHOTOVOLTAIC SYSTEMS (SOLAR I-VW, SOLAR I-VE)

According to the requirements of the laws in force, the result of the test depends on settings about Temperature effects compensation and **PRp** calculations:

Corr. Type	T _{cel} value	PRp calculation	Guideline
T _{mod}	T _{cel} = PV Module Temp. measured	$PRp = \frac{P_{ca}}{\left[Rfv2 \times \frac{G_p}{G_{STC}} \times P_n \right]}$	CEI 82-25 (Italian Guideline)
T _{amb} or T _{env}	T _{cel} = PV module Temp. calculated $T_{cel} = T_{amb} + (NOCT - 20) \times \frac{G_p}{800}$		
nDC	T _{cel} = PV Module Temp. measured	$PRp = \frac{G_{STC}}{G_p} \times \left[1 + \frac{ \gamma }{100} \times (T_{cel} - 25) \right] \times \frac{P_{ca}}{P_n}$	---

where:

Symbol	Description	Meas. unit
G_p	Irradiance on PV module surface	[W/m ²]
G_{STC}	Standard Irradiance = 1000	[W/m ²]
P_n	Nominal Power = sum of all power module (P _{max}) included in the part of PV plant under test	[kW]
P_{ca}	AC Active Power measured	[kW]
$Rfv2 = \begin{cases} 1 & \text{(if } T_{cel} \leq 40^\circ\text{C)} \\ 1 - (T_{cel} - 40) \times \frac{ \gamma }{100} & \text{(if } T_{cel} > 40^\circ\text{C)} \end{cases}$	Thermal Corrective factor	
$ \gamma $	Absolute value of P _{max} thermal coefficient	[%/°C]
NOCT	Normal Operating Cell Temperature (@ 800W/m ² , 20°C, AM=1.5, vel. Aria =1m/s).	[%/°C]

Previous relationship are valid if **Irradiance > Min Irradiance value** and the Irradiance values are “steady”: if $IP \leq 1\text{min} \rightarrow (Irr\ max - Irr\ min) < 20\text{W/m}^2$

The final OUTCOME can be:

- **Non-displayable**: if the obtained values are inconsistent (e.g. PRp >1.15) or if irradiation has never reached a **steady** value > minimum threshold set.
- The maximum performance point (PRp) of the system

The highest performance (maximum value of PRp) is detected according with previous relationships.

11.2. NOTES ON MPPT (MAXIMUM POWER POINT TRACKER)

Solar irradiation on a surface such as the surface of a photovoltaic system has extremely variable characteristics, since it depends on the position of the sun with respect to the surface and on atmospheric conditions (typically, on the presence of clouds). A photovoltaic module presents, for different solar irradiation values, and for different temperature values, a range of characteristic curves of the type shown in the following figure. In particular, the figure shows three I-V curves (in bold) which correspond to three values (1000, 800, 600W/m²) of solar irradiation.

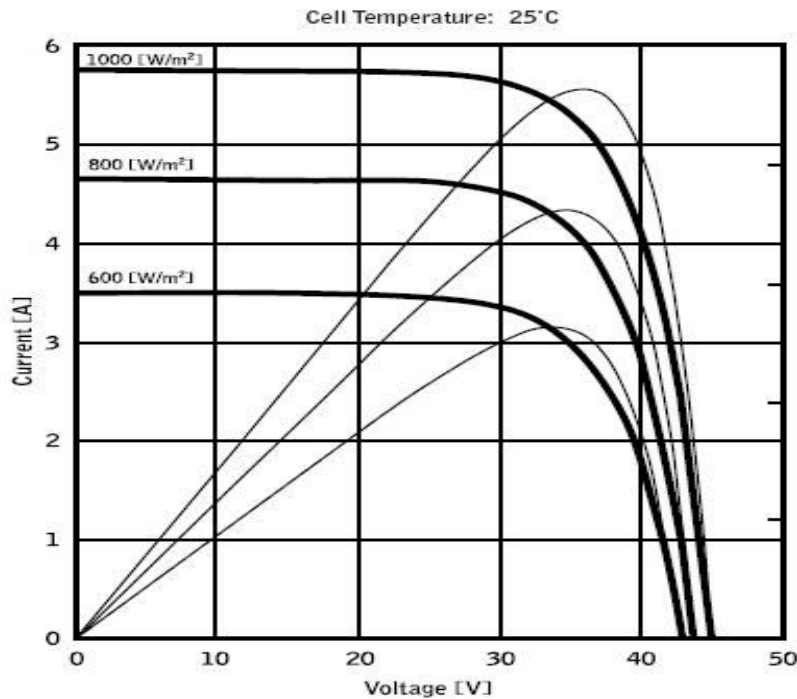

On each characteristic curve there is one single point in which the power transfer towards a hypothetical charge supplied by the photovoltaic module is maximized. The maximum power point corresponds to the voltage-current pair for which the product $V \cdot I$ is maximum, where V is the value of voltage at the module's terminals and I is the current which runs in the circuit obtained by closing the module on a hypothetical charge.

With reference to the figure above, the product $V \cdot I$ is represented, for the three solar irradiation values mentioned above, through the three curves in thinner lines.

The figure shows that, as stated above, these curves only have one single maximum point. For example, for 1000W/m², the maximum power point corresponds to a voltage value of approx. 36V and to a current value of approx. 5.5A.

Obviously, if the power provided by the system is maximized, it is possible to make the most of the system, both in case the system is connected to mains, and in case it is stand-alone.

MPPT is an inbuilt device in the inverters. It typically reads the voltage and current values at any instant, calculates their product (i.e. the power in Watts) and, by causing small variations in the conversion parameters (duty cycle), it is capable of determining, by comparison, if the photovoltaic module is working in maximum power conditions or not. According to the result, it operates again on the circuit in order to bring the system to an optimal condition.

The reason why MPPTs are used is simple: a photovoltaic system without MPPTs may operate anyway; however, with the same solar irradiation, it provides less energy.

There are inverters with 1, 2 or also 3 inbuilt MPPTs available on the market. Typically, the inverters with more than one MPPT are used in systems where:

- the different photovoltaic systems it consists of “forcibly” have different inclinations or directions. In this way, each single MPPT manages its own photovoltaic field, maximizing its performance for the corresponding irradiation and temperature characteristics (without being influenced by the other photovoltaic fields).
- a greater service continuity is sought. With more MPPTs it is possible to put one single photovoltaic field out of service, while the others continue producing energy towards the remaining MPPTs.

11.3. THEORETICAL ASPECTS OF THE I-V CURVE MEASUREMENT

The I-V curve test is performed as described below:

- The meter performs the I-V curve measurement of the PV module connected to it, further to the real time measurement of irradiance and module temperature
- The results of measurements are automatically “translated” to the standard conditions (STC) of irradiance at **1000 W/m²** and module temperature at **25°C**. The accuracy indicated in this manual is granted under condition indicated in § 10.2.
- The meter performs a comparison between the maximum nominal power, with the margin of percentage tolerance declared by the module’s manufacturer, which is included in the kind of module selected on the meter from the database (§ 5.3.1), and the measured value
- If the comparison of power is within the declared tolerance, the final response of the meter will be “OK” or will be “NO OK” in the opposite case, and the module will not be complying with the specifications declared by the manufacturer (§ 6.2.3)

11.3.1. Typical errors on I-V curves and troubleshooting

Measurement	Event	Troubleshooting
Good measurement 	<ul style="list-style-type: none"> The measured curve extrapolated to STC (blue) and the curve as declared by the manufacturer (black) of the modules match. 	<ul style="list-style-type: none"> No error, save data and move to next string to test
Low short circuit current 	<ul style="list-style-type: none"> Irradiance sensor oriented differently than the string under test Reflections on the irradiance sensor Wrong module selection at configuration of PV system Environmental contaminants on modules (soiling, dirt, snow, debris) Far distance obstruction (shading) Aging 	<ul style="list-style-type: none"> Orient the irradiance sensor properly Set the instrument properly Clean the modules Remove obstruction Check the modules for blindness, humidity, etc. Replace affected modules
High short circuit current 	<ul style="list-style-type: none"> Irradiance sensor oriented differently than the string under test Shades on the irradiance sensor Dirt on the irradiance sensor Wrong module selection at configuration of PV system Irradiance sensor defect 	<ul style="list-style-type: none"> Orient the irradiance sensor properly Clean the irradiance sensor Remove obstruction Check the irradiance sensor for blindness, humidity, etc. Set the instrument properly Replace affected sensor
Low open circuit voltage 	<ul style="list-style-type: none"> Low temperature measurement Wrong numbers of module selection at configuration of PV system Shorted bypass diodes 	<ul style="list-style-type: none"> Attach the thermocouple properly to a typical temperature location Select the AUTO mode Set the instrument properly Replace affected modules
Low current ratio I_{mpp}/I_{sc} 	<ul style="list-style-type: none"> Soiling across modules Tapered shades Small current mismatch Degradation of cell shunt resistance 	<ul style="list-style-type: none"> Clean the modules Un-shade the modules Check the current match Replace affected modules
Low voltage ratio V_{mpp}/V_{oc} 	<ul style="list-style-type: none"> Voltage drop on cables to PV module string 	<ul style="list-style-type: none"> Check cables, connectors, contacts, and string wirings Check cable length and cross section Check modules for bad connections or oxidation Replace affected modules

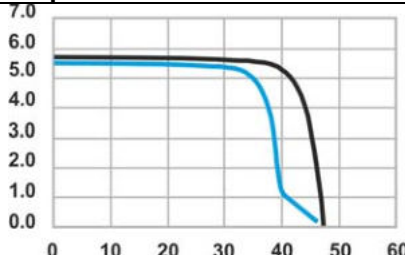
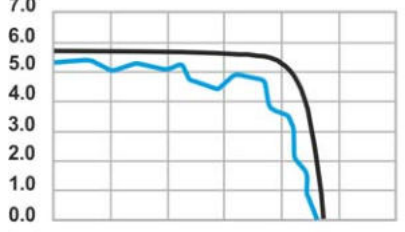
<p>Steps in the I-V curve</p> 	<ul style="list-style-type: none"> • Small or partial shading of one module of the string under test • Reflections • Random environmental contaminants on modules (soiling, dirt, snow, debris, etc.) • Strong current mismatch • Cracks of cells or glass • Burn marks 	<ul style="list-style-type: none"> • Remove obstructions • Re-test when un-shaded • Remove reflections • Clean the modules • Check the current match • Replace affected modules
<p>Characteristic curve not linear</p> 	<ul style="list-style-type: none"> • Unsteady irradiation during measurement • Leopard spot clouds shading the modules • Low irradiation during measurement 	<ul style="list-style-type: none"> • Re-test when clouds are gone • Repeat measurement at an irradiation of minimum 700W/m^2 (IEC/EN61829)

12. SERVICE

12.1. WARRANTY CONDITIONS

This instrument is guaranteed against any defect in material and manufacturing in compliance with the general sales terms and conditions. Throughout the period of guarantee all defective parts may be replaced and the manufacturer reserves the right to repair or replace the product.

If the instrument is to be returned to the after-sales service or to a dealer transportation costs are on the customer's behalf. Shipment shall be however agreed upon. A report must always be enclosed to a rejected product stating the reasons of its return. To ship the instrument use only the original packaging material; any damage that may be due to non-original packing shall be charged to the customer. The manufacturer declines any responsibility for damages caused to persons and/or objects.

Warranty is not applied in the following cases:

- Repair and/or replacement of accessories and battery (not covered by warranty)
- Any repair that might be necessary as a consequence of a misuse of the instrument or of its use with no compatible devices.
- Any repair that might be necessary as a consequence of improper packaging.
- Any repair that might be necessary as a consequence of service actions carried out by unauthorized personnel.
- Any modification of the instrument carried out without the authorization of the manufacturer.
- Use not provided for in the instrument's specifications or in the instruction manual.

The contents of this manual may not be reproduced in any form whatsoever without the manufacturer's authorization.

All our products are patented and their trade marks registered. The manufacturer reserves the right to modify the product specifications and prices if this is aimed at technological improvements.

12.2. SERVICE

If the instrument does not operate properly, before contacting the after-sales service check cables as well as test leads and replace them if necessary. Should the instrument still operate improperly check that the operation procedure is correct and conforms with the instructions given in this manual. If the instrument is to be returned to the after-sales service or to a dealer, transportation costs are on the customer's behalf. Shipment shall be however agreed upon. A report must always be enclosed to a rejected product stating the reasons of its return. To ship the instrument use only the original packaging material; any damage that may be due to non-original packing shall be charged to the customer.



HT INSTRUMENTS SA

C/ Legalitat, 89
08024 Barcelona - **ESP**
Tel.: +34 93 408 17 77, Fax: +34 93 408 36 30
eMail: info@htinstruments.com
eMail: info@htinstruments.es
Web: www.htinstruments.es

HT INSTRUMENTS USA LLC

3145 Bordentown Avenue W3
08859 Parlin - NJ - **USA**
Tel: +1 719 421 9323
eMail: sales@ht-instruments.us
Web: www.ht-instruments.com

HT ITALIA SRL

Via della Boaria, 40
48018 Faenza (RA) - **ITA**
Tel: +39 0546 621002
Fax: +39 0546 621144
eMail: ht@htitalia.it
Web: www.ht-instruments.com

HT INSTRUMENTS GMBH

Am Waldfriedhof 1b
D-41352 Korschenbroich - **GER**
Tel: +49 (0) 2161 564 581
Fax: + 49 (0) 2161 564 583
eMail: info@ht-instruments.de
Web: www.ht-instruments.de

HT INSTRUMENTS BRASIL

Rua Aguaçu, 171, bl. Ipê, sala 108
13098321 Campinas SP - **BRA**
Tel: +55 19 3367.8775
Fax: +55 19 9979.11325
eMail: vendas@ht-instruments.com.br
Web: www.ht-instruments.com.br

HT ITALIA CHINA OFFICE

意大利 HT 中国办事处
Room 3208, 490# Tianhe road, Guangzhou - **CHN**
地址 : 广州市天河路 490 号壬丰大厦 3208 室
Tel.: +86 400-882-1983, Fax: +86 (0) 20-38023992
eMail: zenglx_73@hotmail.com
Web: www.guangzhouht.com