



# THT100 – THT200 THT300 – THT400



User manual

UK  
CA  
CE





**TABLE OF CONTENTS**

1	PRECAUTIONS AND SAFETY MEASURES .....	3
1.1	During use .....	3
1.2	After use .....	3
2	GENERAL DESCRIPTION .....	4
3	PREPARATION FOR USE .....	5
3.1	Initial checks .....	5
3.2	Instrument power supply .....	5
3.3	Storage .....	5
4	NOMENCLATURE .....	6
4.1	Description of the instrument .....	6
4.2	Description of function keys .....	9
4.2.1	Switching on the instrument .....	9
4.2.2	Switching off the instrument .....	9
4.2.3	Key  .....	10
4.2.4	T key (Trigger) .....	10
4.2.5	Key MENU/OK .....	10
4.2.6	Key  .....	10
5	USING THE INSTRUMENT .....	11
5.1	Description of the main interface .....	11
5.2	Image focusing .....	12
5.3	Main menu description .....	13
5.3.1	Settings Menu .....	14
5.3.1.1	Menu "Device Settings" .....	14
5.3.1.2	Menu "Measure settings" .....	19
5.3.1.3	Menu "Reset" .....	23
5.3.2	Measurement Menu .....	25
5.3.3	Menu Image and Zoom .....	28
5.3.4	Menu Palette and isotherm lines' functions .....	30
5.3.5	Menu Parameters .....	33
5.3.6	Alarm menu .....	36
5.4	Adjusting the image temperature .....	37
5.5	Saving IR images and videos .....	39
5.5.1	Image saving .....	39
5.5.2	Recording IR videos .....	40
5.5.3	Gallery menu .....	40
5.6	Characteristics of the lens .....	42
5.7	Use of the Screening mode .....	43
6	USING THE THTLINK SOFTWARE .....	44
6.1	Minimum system requirements .....	44
6.2	Installing the THTLink software .....	44
6.3	Main characteristics of the THTLink software .....	44
7	MAINTENANCE .....	45
7.1	General information .....	45
7.2	Recharging the internal battery .....	45
7.3	Cleaning the instrument .....	46
7.4	End of life .....	46
7.5	Accessories .....	46
7.5.1	Accessories provided .....	46
7.5.2	Accessories optional .....	46
8	TECHNICAL SPECIFICATIONS .....	47
8.1	Environment .....	48
8.1.1	Environmental conditions for use .....	48
9	ASSISTANCE .....	49
9.1	Warranty conditions .....	49
9.2	Assistance .....	49

## 1 PRECAUTIONS AND SAFETY MEASURES

In the whole manual, the word “instrument” generically indicates **THT100**, **THT200**, **THT300** and **THT400** models unless otherwise indicated. The instrument has been designed in compliance with the directives relevant to electronic measuring instruments. For your safety and to prevent damaging the instrument, please carefully follow the procedures described in this manual and read all notes preceded by symbol  with the utmost attention. Before and after carrying out the measurements, carefully observe the following instructions:

### CAUTION



- Do not carry out any measurements in case gas, explosive materials or flammables are present, or in humid or dusty environments
- Do not carry out any measurement in case you find anomalies in the instrument such as deformation, breaks, substance leaks, absence of display on the screen, etc
- Keep the instrument steady during any measuring operation
- **Do not use the instrument in environments with temperatures exceeding the operating and storage limits specified in § 8.1.1 in order not to damage it**
- Only the accessories provided together with the instrument will guarantee safety standards. They must be used only if in good conditions and replaced with identical models, when necessary
- Check that the battery is correctly inserted
- Check that the LCD display gives indications consistent with the function selected
- **Do not direct the instrument at very high intensity radiation sources (e.g. the sun) in order to prevent damaging the IR sensor**
- Prevent hits or strong vibrations in order to keep the instrument from damage
- When bringing the instrument from a cold to a hot environment, leave it on long enough for condensation water to evaporate

In this manual, and on the instrument, the following symbol is used:



Warning: observe the instructions given in this manual; improper use could damage the instrument or its components.

### 1.1 DURING USE



### CAUTION

- Failure to comply with the caution notes and/or instructions may damage the instrument or be a source of danger for the operator.
- Use the instrument only in the temperature ranges indicated in § 8.1.1.

### 1.2 AFTER USE

When measurement is complete, switch off the instrument. If you expect not to use the instrument for a long period, remove the battery.

## 2 GENERAL DESCRIPTION

The instrument is a professional digital thermal camera capable of carrying out infrared temperature measurements of objects and providing high-resolution images in an extremely flexible way. It is also very easy to use and needs little maintenance.

The main characteristics of the instrument are:

- Temperature measurement ranging from -20°C to 650°C (THT100, THT200, THT300)
- Temperature measurement ranging from -20°C to 550°C (THT400)
- Built-in photo camera for a visible image
- PiP Fusion and Auto Fusion (AUF) function
- Cursor in a fixed central position
- Cursors for automatic detection of “hot” and “cold” spots of the image
- TFT color display with capacitive touchscreen
- Alarm conditions on temperature measurement
- 8 color palettes available
- Electronic zoom x1-x32
- Advanced analyses (Spots, Lines, Areas, Isotherm lines)
- Automatic detection of hot/cold spots of the image
- “Screening” function for a quick measurement of surface temperature
- Storage of JPG images on external micro-SD card and in the internal memory
- IR sensor resolution: 384x288pxl (THT300), 160x120pxl (THT200), 80x80pxl (THT100)
- IR sensor resolution: 640x480pxl (THT400)
- USB port for PC connection and image and video transfer
- Text annotation on saved images
- IR MP4 video recording on micro-SD card and in the internal memory
- Rechargeable Li-ION battery
- Analysis and creation of reports with the provided dedicated software
- WiFi interface to mobile devices through the APP **HTProCamera**

The applications of the digital thermal camera are:

- Predictive and preventive maintenance of electrical and mechanical appliances
- Monitoring of the temperature of working processes
- Maintenance and troubleshooting on forced ventilation ducts
- Domestic/industrial use in troubleshooting room insulation problems
- Applications in the construction field
- Safety problems

### **3 PREPARATION FOR USE**

#### **3.1 INITIAL CHECKS**

Before shipping, the instrument has been checked from an electric as well as mechanical point of view. All possible precautions have been taken so that it is delivered undamaged. However, we recommend generally checking the instrument in order to detect possible damage suffered during transport. In case anomalies are found, immediately contact the forwarding agent. We also recommend checking that the packaging contains all components indicated in § 7.5. In case of discrepancy, please contact the Dealer. In case the instrument should be returned, please follow the instructions given in § 9.

#### **3.2 INSTRUMENT POWER SUPPLY**

The instrument is supplied by a 1x3.7V, 2600mAh rechargeable Li-ION battery and AC mains power supply, which also provides for the recharge of the mentioned battery. Both of these systems are provided together with the instrument. For battery recharge, please refer to § 7.2.

#### **3.3 STORAGE**

In order to guarantee precise measurement, after a long storage time under extreme environmental conditions, wait for the instrument to come back to normal operating conditions (see § 8.1.1).

## 4 NOMENCLATURE

### 4.1 DESCRIPTION OF THE INSTRUMENT

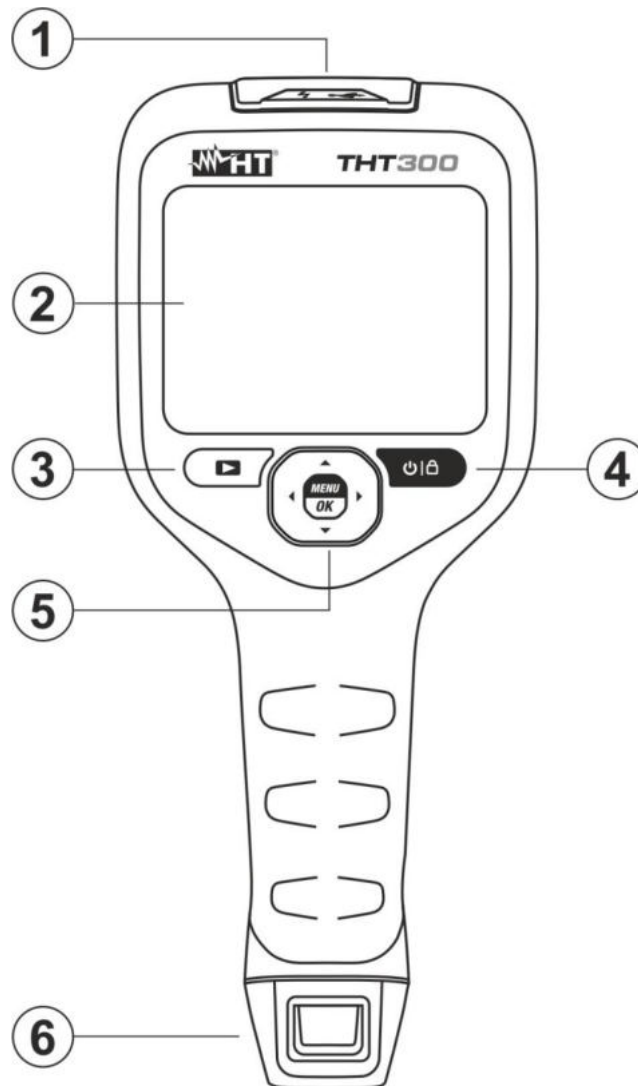

Fig. 1: Description of the instrument's backside

#### CAPTION:

1	USB-C and micro SD section
2	LCD touch-screen display
3	Function key  (Image/video gallery)
4	Function key  (ON/OFF and Measuring Mode)
5	Function key <b>MENU/OK</b> and arrow keys , , ,
6	Rechargeable battery

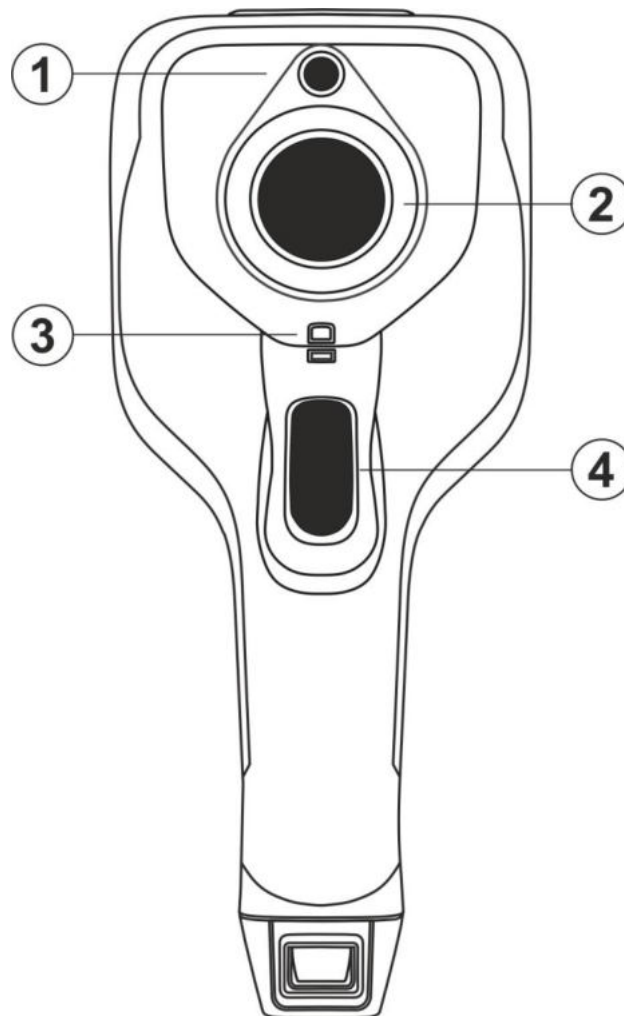

Fig. 2: Description of the instruments front side

CAPTION:

1	Photo camera
2	IR sensor
3	Slot for non-slip strap insertion of protection lens cover
4	Trigger key (T)

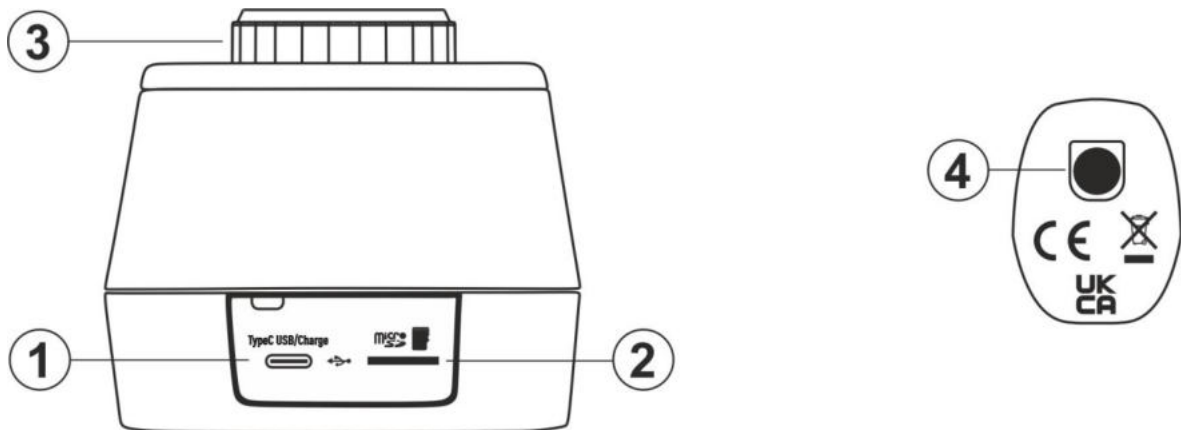

Fig. 3: Description of the upper and bottom parts of the instrument

CAPTION

1	USB-C output for PC / external charger connection
2	Slot for micro SD card insertion
3	Lens associated with the IR sensor
4	Threaded hole ( $\frac{1}{4}$ " ) for tripod insertion

## 4.2 DESCRIPTION OF FUNCTION KEYS

The instrument has 7 function keys described further in this text and a trigger key “T” with multiple functions.

### 4.2.1 Switching on the instrument

1. Press and hold key for **2s** to switch on the instrument. After the initial splash screen is displayed (see Fig. 4 – left side), the instrument needs for a certain heating time (approx. 30s) in order to provide accurate temperature measurements and quality images.
2. The instrument initially shows the visible image for a few seconds and the message “**IR calibration...**” while it correctly calibrates the internal sensor (see Fig. 4 – middle).
3. After a few seconds, the IR image is shown on the display and the instrument is ready for measurement (see Fig. 4 – right side).



Fig. 4: Sequence upon switching on the instrument

### CAUTION



- The sound that accompanies the message “IR calibration...” is a necessary condition for the instrument's internal calibration.
- Pressing the key allows switching on/off the instrument. The instrument also has an Auto-Power-Off function with selectable time.

### 4.2.2 Switching off the instrument

1. Press and hold key for **at least 4s** to switch off the instrument. The following screen appears on the display.



Fig. 5: Switching off the instrument

2. Touch the virtual button “OK” to switch off the instrument.
3. Touch the virtual button “Cancel” to cancel the operation and go back to normal display.
4. By pressing and holding the key for **at least 7s**, the instrument is directly switched off.

#### 4.2.3 Key

Press key  to enter the gallery of images/videos saved in the internal memory or on the inserted micro SD card (see § 5.5.3).



#### 4.2.4 T key (Trigger)

Pressing the **T** key on the front of the instrument allows freezing the IR image on the display and automatically opens the image saving section (see § 5.5.1). Press the **T** key again to save the image on the display or touch the display to return to normal viewing

#### 4.2.5 Key MENU/OK

Pressing the key **MENU/OK** allows displaying/hiding the instrument's main menu (see § 5.3). The operation is always possible also by touching the display.

#### 4.2.6 Key

Long pressing key  allows switching on/off the instrument (see § 4.2.1 and § 4.2.2). With the instrument switched on, by pressing key  several times, it is possible to select the image temperature adjusting modes (see § 5.4).

## 5 USING THE INSTRUMENT

### 5.1 DESCRIPTION OF THE MAIN INTERFACE

The instrument shows the following interface on the display:

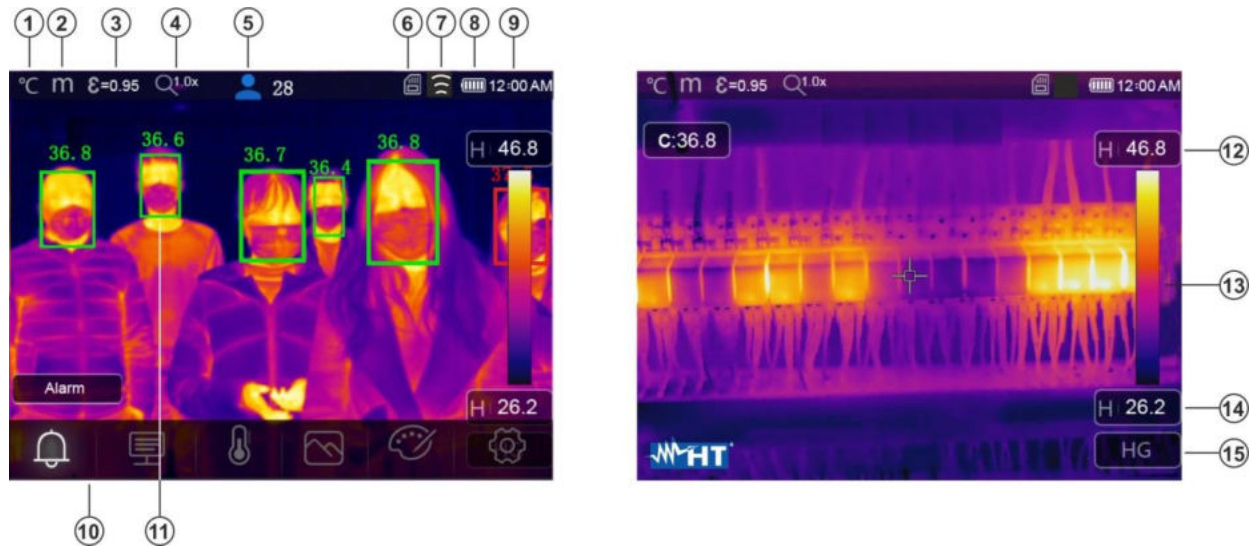

Fig. 6: Main instrument interface

#### CAPTION

1	Measuring unit of temperature ( $^{\circ}\text{C}$ , $^{\circ}\text{F}$ , K)
2	Measuring unit of distance (m, Ft)
3	Set emissivity value
4	Active zoom indication
5	Number of detections statistically valid in Face Mode (see § 5.3.2)
6	Presence of micro SD card in the instrument
7	Active WiFi connection
8	Battery charge level
9	System time
10	Main instrument menu
11	Detection of the person's face and maximum measured temperature
12	Maximum temperature associated to the image on the display
13	Set color palette
14	Minimum temperature associated to the image on the display
15	Indication of the selected adjustment mode (Manual, Auto, HG)

## 5.2 IMAGE FOCUSING

Focusing the IR image found on the instrument display must be performed manually (THT200, THT300) by rotating the lens installed on the IR sensor (see Fig. 3 – Part 3). Keep the instrument steady while performing this operation.

### CAUTION



- Always focus the image before saving it, in order to perform correct temperature measurements of the framed target.
- The IR image on the display may be out of focus after a few minutes or if a new object is framed. In order to solve this problem, the instrument performs its internal calibration and makes a sound which must be considered as fully normal.



Fig. 7: Focusing the image on the display

The correct focusing of the image allows for the whole of the infrared energy irradiated by the target to be directed at the pixels of the IR sensor. Without focusing, the thermal image may be out of focus and the indicated radiometric data will be inaccurate.

### 5.3 MAIN MENU DESCRIPTION

By pressing the key **MENU/OK** or by simply touching the display, the instrument shows/hides the following main menu on the display. Use the touch-screen or the arrow keys to select menu items.

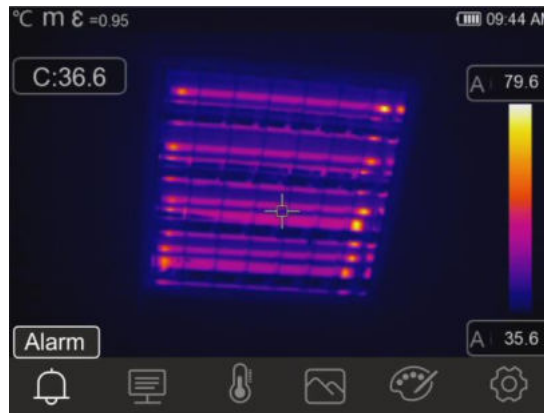









Fig. 8: Main instrument menu

The following options are available:

- Menu **Alarm**  → allows setting the alarm thresholds on the temperature measurements associated with the items inserted onto the image (cursor, dots, lines and areas).
- Menu **Parameters**  → defines the values of the correction parameters used for temperature measurement.
- Menu **Measurement**  → allows inserting items (dots, lines, areas) onto the image with the relevant associated temperature values.
- Menu **Image**  → allows selecting the display mode of the framed target as regards thermal image, visible image and combinations thereof. In the same section it is also possible to use the function for measuring the distance from target.
- Menu **Palette**  → allows selecting the available color palettes and setting the visible alarm conditions according to the measured temperature.
- Menu **Settings**  → allows setting system parameters, the type of measurement, the values of the compensation parameters and the reset of the instrument.

### 5.3.1 Settings Menu

By touching the icon , the instrument enters the “Settings” menu, in which it is possible to define the values of system parameters, the settings of measurements and the reset of the instrument. The following screen appears on the display:

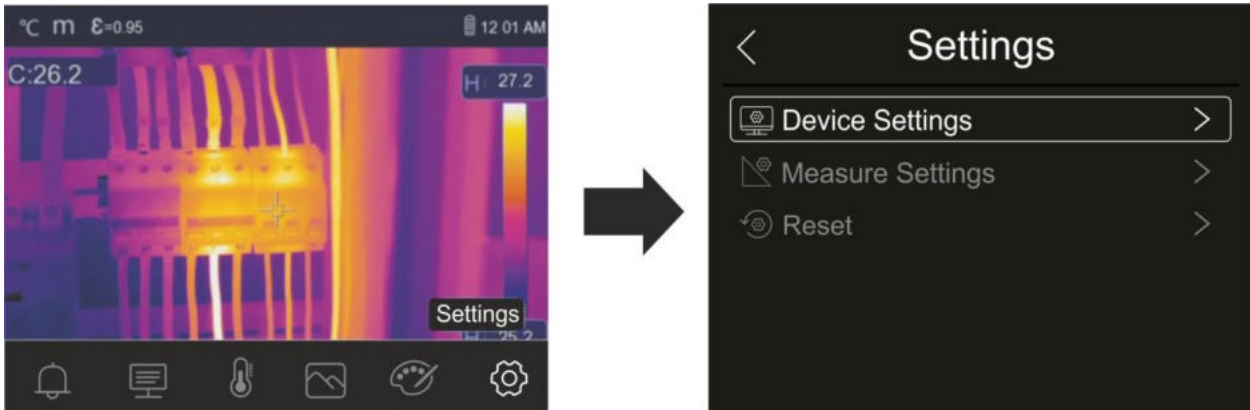

Fig. 9: Section Setting of the general menu

#### 5.3.1.1 Menu “Device Settings”

In this section (see Fig. 10) it is possible to define the instrument's system parameters. Touch the screen to activate/deactivate the desired options.

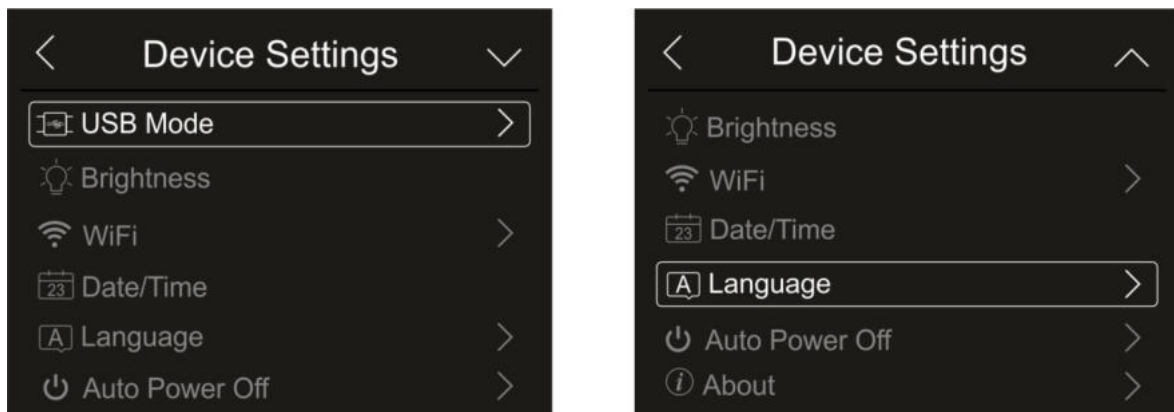

Fig. 10: Instrument settings

#### USB mode

1. Touch the item “USB mode”. The following screen appears on the instrument's display:

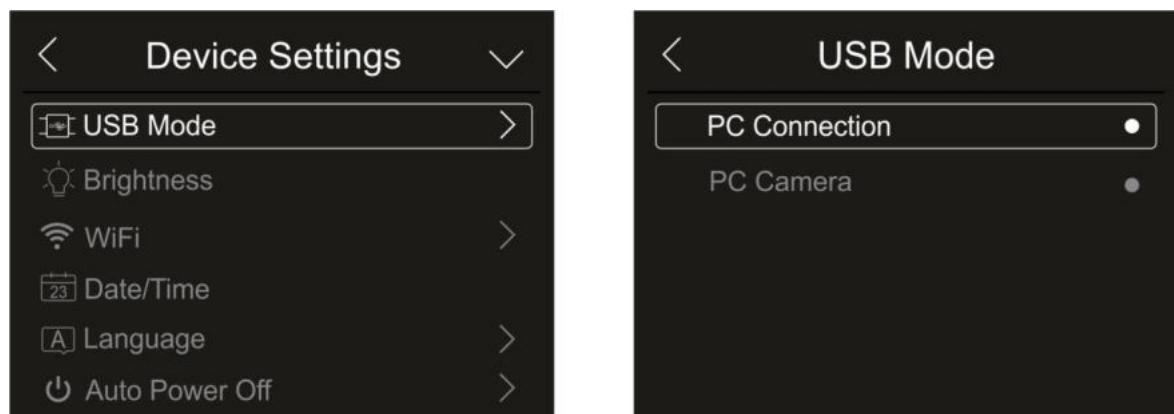

Fig. 11: USB mode

2. Touch the option “PC Connection” to make the instrument communicate with the PC.

3. Connect the instrument to the PC via the provided USB cable. The screen in Fig. 12 – left side appears on the display:

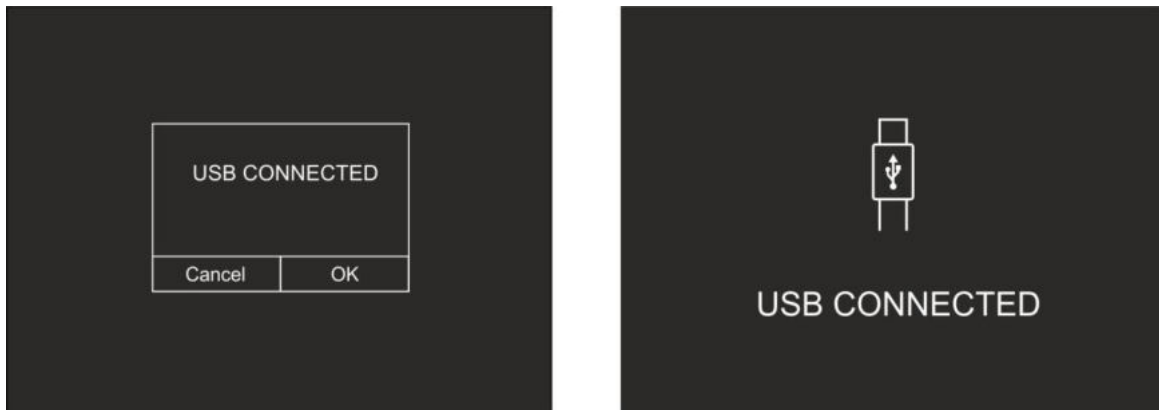

Fig. 12: Connecting the instrument to the PC

4. Confirm with “OK” to activate the connection, or touch “Cancel” to go back to the main menu. The screen in Fig. 12 – right side appears on the display, and the instrument does not accept any command.
5. The instrument is detected by the PC like a “Removable disk” and it will be possible to download the IR images/videos found in the internal memory or on the inserted micro SD card.
6. Disconnect the USB cable from the instrument in order to restore normal operation.
7. Select option “PC Camera” to allow displaying on the PC in real time the image shown on the display. Within “**My Computer**”, search for the “USB video device” which is automatically recognized by the PC and allows showing the (IR or visible) image found on the display in real time. **Re-boot the instrument to make active the function**

### Display brightness

1. Touch the item “Brightness” to adjust display brightness. The following screen appears on the display:

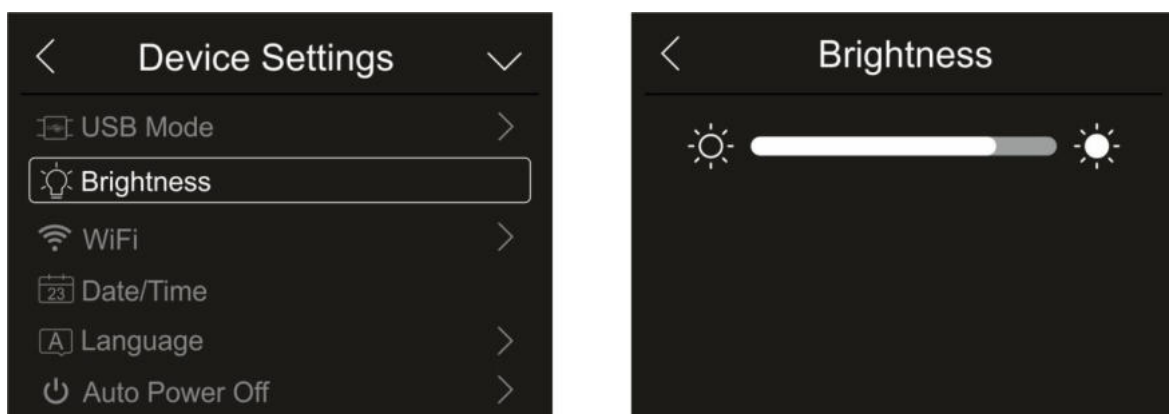

Fig. 13: Adjusting display brightness

2. Touch and drag the white bar to adjust brightness, observing the display as you do so.

### Activation of WiFi connection

1. Touch the item “WiFi” to enter the section for the activation/deactivation and customization of the instrument's WiFi connection. The screen in Fig. 14 – right side appears on the display.



#### CAUTION

**WiFi connection only allows carrying out the instrument's connection to mobile devices (Android/iOS) through the dedicated APP HTProCamera**

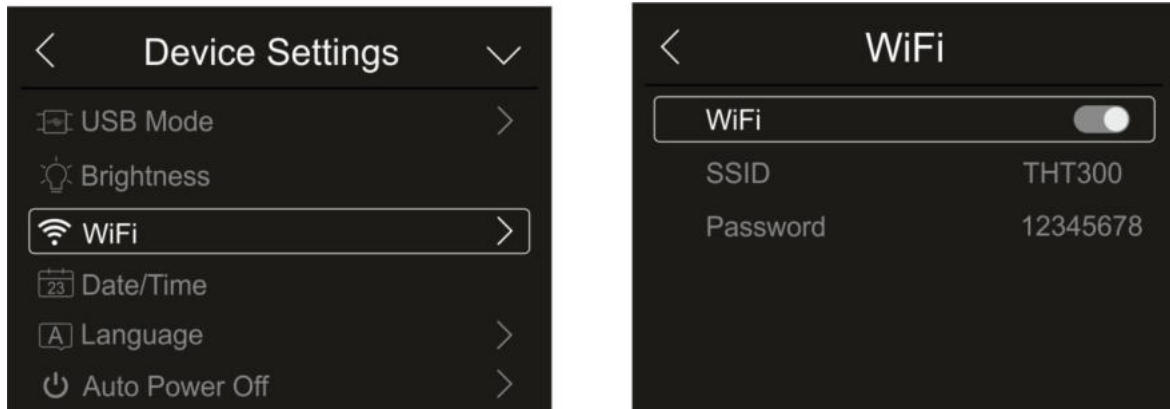

Fig. 14: Activation of WiFi connection

2. Touch the icon “” to activate WiFi connection, or icon “” to deactivate WiFi connection. The icon “” is shown on the display
3. Touch item “SSID” to define a custom identification ID of the WiFi connection. The screen in Fig. 15 – left side appears on the display.

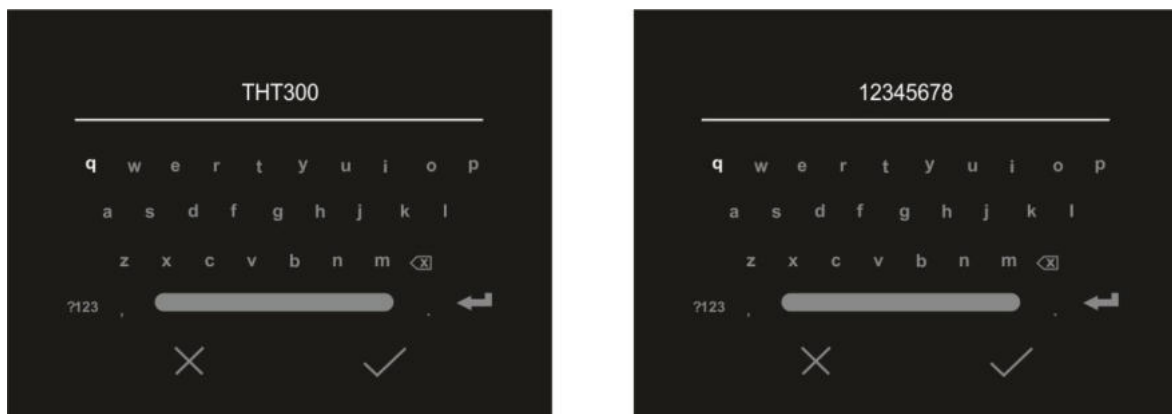

Fig. 15: Definition of SSID and Password of the WiFi connection

4. Define the desired name of the SSID and touch the icon “” to confirm, or icon “” to quit without changes.
5. Touch item “Password” to define a custom Password for the WiFi connection (default “12345678”). The screen in Fig. 15 – right side appears on the display.
6. Define the desired Password (**max 8 digits**) and touch the icon “” to confirm, or icon “” to quit without changes.

### Date/Time setting

1. Touch the item “Date/Time” to set the system's Date/Time. The screen in Fig. 16 – right side appears on the display:

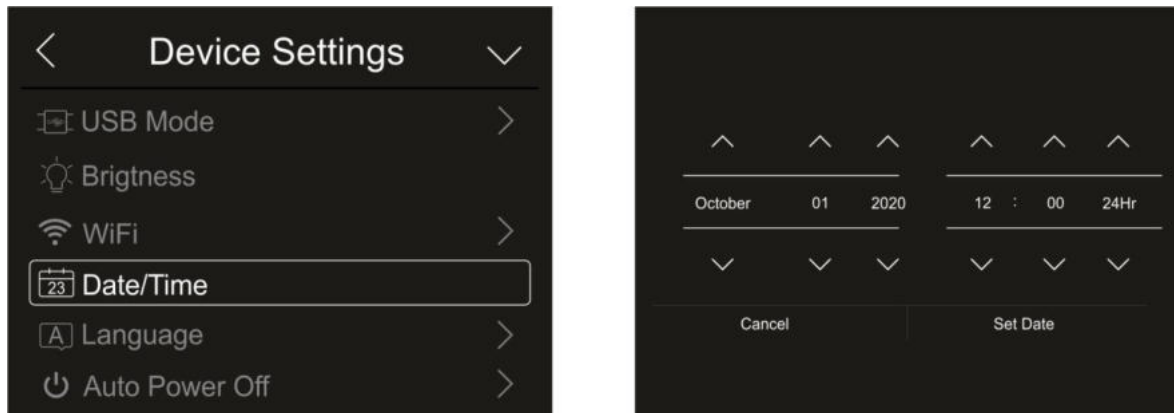

Fig. 16: System date/time setting

2. Touch the arrows “ $\wedge$ ” or “ $\vee$ ” to perform setting. Options “AM” and “PM” indicate the time in a (0-12h) format, whole option “24Hr” indicates format (0-24h). Touch “Set Date” to confirm, or “Cancel” to quit without changes.

### Language setting

1. Touch the item “Language” to set the system's Language. The screen in Fig. 17 – right side appears on the display:

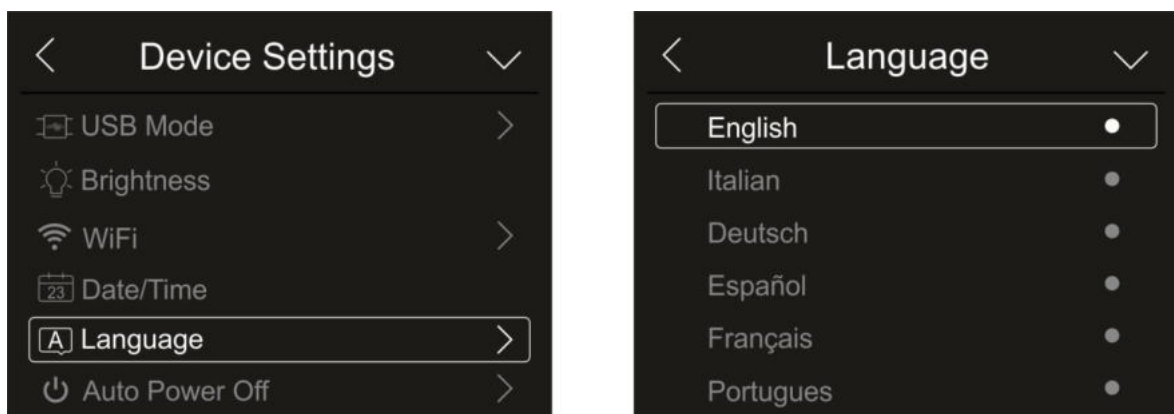

Fig. 17: System language setting

2. Select the desired language by scrolling down the list with the arrow key “ $\vee$ ” and quit the section by touching the arrow key “ $\leftarrow$ ” to confirm setting.

### Auto power off setting

1. Touch item “Auto Power Off” to set the instrument's auto power off time. The screen in Fig. 18 – right side appears on the display:

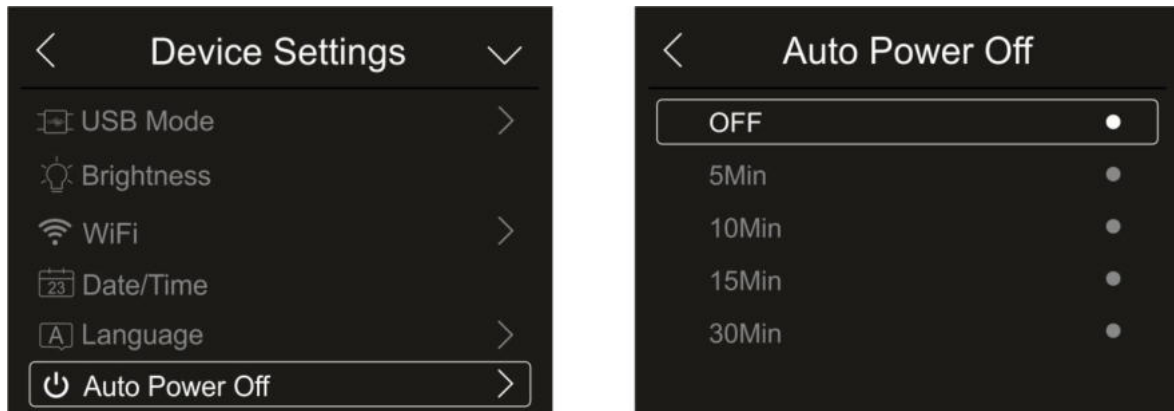

Fig. 18: Auto power off setting

2. Select one of the options: “**OFF**” (deactivation), **5Min**, **10Min**, **15Min** or **30Min** and touch the arrow key “<” to quit and confirm setting.

### Information on the instrument

1. Touch the item “About” to display the information about the instrument ad regards: model, serial number, internal Firmware version and available residual memory. The screen in Fig. 19 – right side appears on the display:

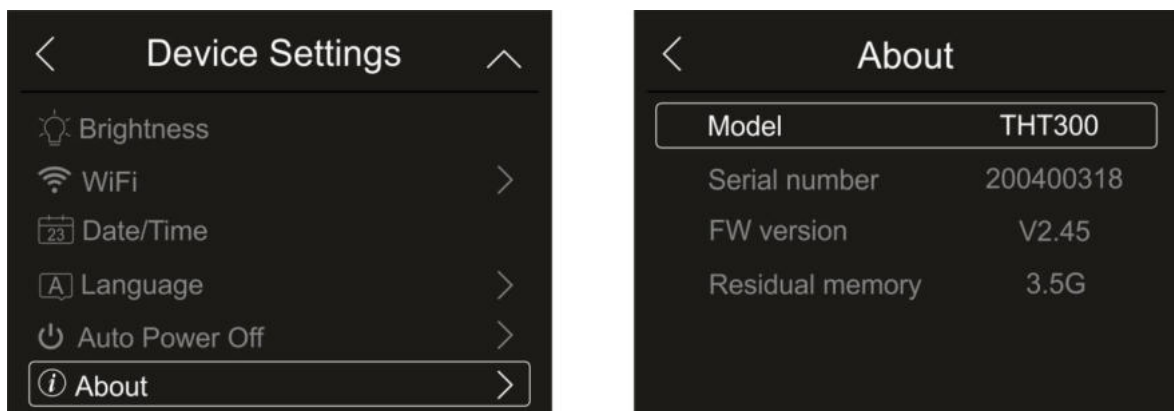

Fig. 19: Information on the instrument

2. Touch the arrow key “<” to quit and confirm.

### 5.3.1.2 Menu “Measure settings”

In this section (see Fig. 20), it is possible to define the type of measurement, the values of the compensation parameters and the settings of the alarm conditions. Touch the screen to activate/deactivate the desired options.

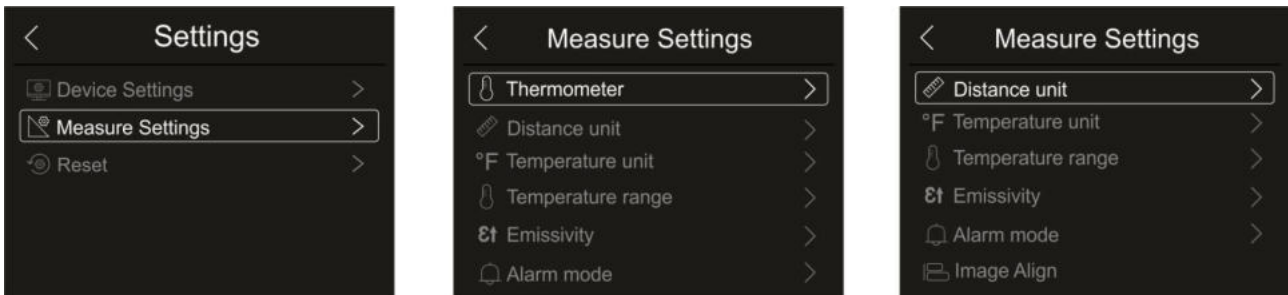

Fig. 20: Menu “Measure settings”

#### Thermometer section

In this section it is possible to define the following temperature measuring modes:

- **Normal mode** → the instrument measures the surface temperature of any object (according to its emissivity) in the range: **-20°C ÷ 150°C / 0°C ÷ 650°C (THT100, THT200, THT300)** and **-20°C ÷ 150°C / 0°C ÷ 550°C (THT400)** with accuracy  $\pm 2^\circ\text{C}/\pm 2\%$  reading
- **Screening mode** → the instrument measures the temperature of **parts of the human body** in the range: **32.0°C ÷ 42.0°C** with accuracy  $\pm 0.5^\circ\text{C}$ . This mode is also used to evaluate whether a person has a fever or not (see § 5.7).

1. Touch the item “Thermometer”. The screen in Fig. 21 – right side appears on the display:

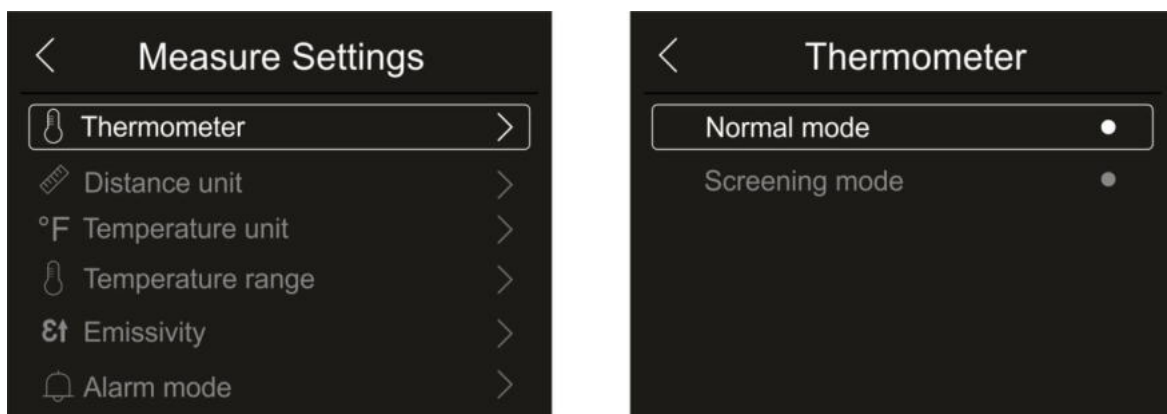

Fig. 21: Menu Thermometer

2. Touch one of the options “Normal mode” or “Screening Mode” and the arrow key “<” to quit and confirm setting.

### Setting the distance measuring unit

1. Touch the item “Distance unit” to set the measuring unit of distance. The screen in Fig. 22 – right side appears on the display:

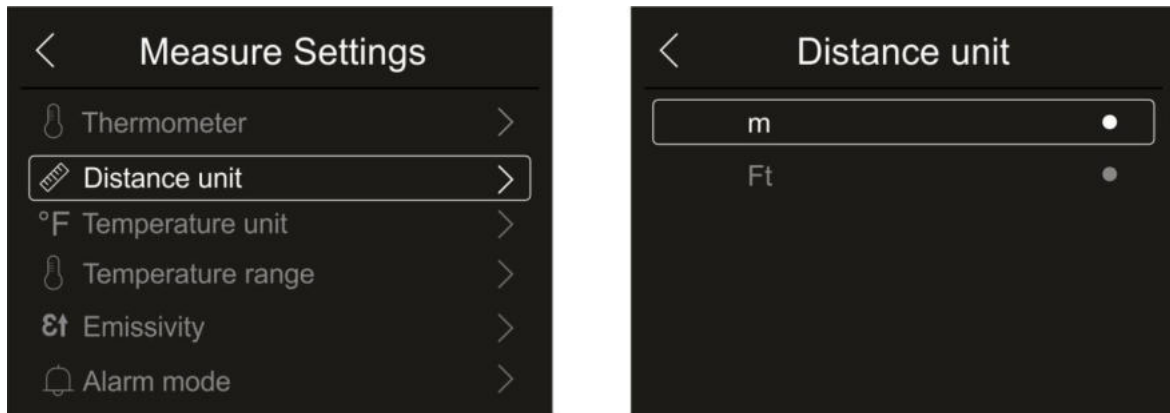

Fig. 22: Menu Setting the distance measuring unit

2. Touch one of the options “m” (meters) or “Ft” (feet) and the arrow key “<” to quit and confirm setting.

### Setting the temperature measuring unit

1. Touch the item “Temperature unit” to set the measuring unit of temperature. The screen in Fig. 23 – right side appears on the display:

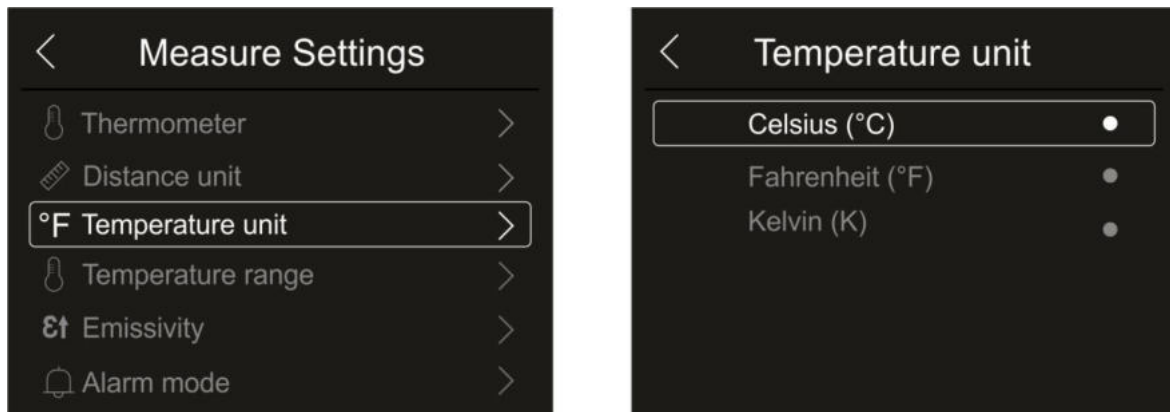

Fig. 23: Menu Setting the temperature measuring unit

2. Touch one of the options “°C” (Celsius), “°F” (Fahrenheit), “K” (Kelvin) and the arrow key “<” to quit and confirm setting.

### Setting of temperature range

1. Touch the item “Temperature range” to set the instrument's measuring range of temperature (This option is relevant to the relevant to the Normal measuring mode). The screen in Fig. 24 – right side appears on the display:



Fig. 24: Menu Setting the temperature measuring range

2. Touch one of the options “-20÷150°C” or “0÷650°C” and the arrow key “<” to quit and confirm.

### Setting Emissivity of the material

1. Touch item “Emissivity” to set the emissivity values of the item whose temperature needs to be measured. In order to carry out accurate temperature measurements, it is important to define the correct value of this parameter, which represents the ability of a body to emit infrared radiation, according to the kind of material the measured object is made of. Table 1 shows the emissivity values for the most common materials. Emissivity takes values between 0 (mirror or perfectly reflecting surface) and 1 (perfectly radiating blackbody). Most of the painted or oxydized surfaces have an emissivity value of approximately 0.95.

Material	$\epsilon$
Water	0.96
Stainless steel	0.14
Aluminium foil	0.09
Asphalt	0.96
Cement	0.97
Cast iron	0.81
Rubber	0.95
Wood	0.85
Bricks	0.75
Tape	0.96
Brass foil	0.06
Human skin	0.98
PVC plastic	0.93
Polycarbonate	0.80
Oxydized Copper	0.73
Rust	0.80
Paint	0.90
Earth	0.93

Table 1: Emissivity values of typical materials

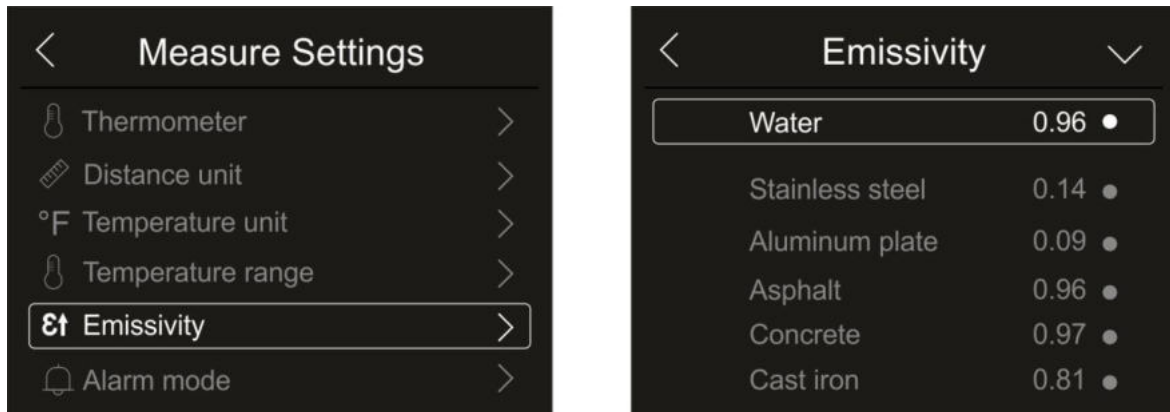

Fig. 25: Emissivity setting menu

2. Touch one of the items corresponding to the type of material and the arrow key “<” to quit and confirm. To customize the emissivity value, see § 5.3.5.

### Setting Alarm mode

1. Touch the item “Alarm mode” to activate the acoustic alarm thresholds on temperature measurement associated to the objects inserted onto the image (cursor, dots, lines and areas) associated to the “Alarm” function in the main menu (see § 5.3). The screen in Fig. 26 – right side appears on the display:

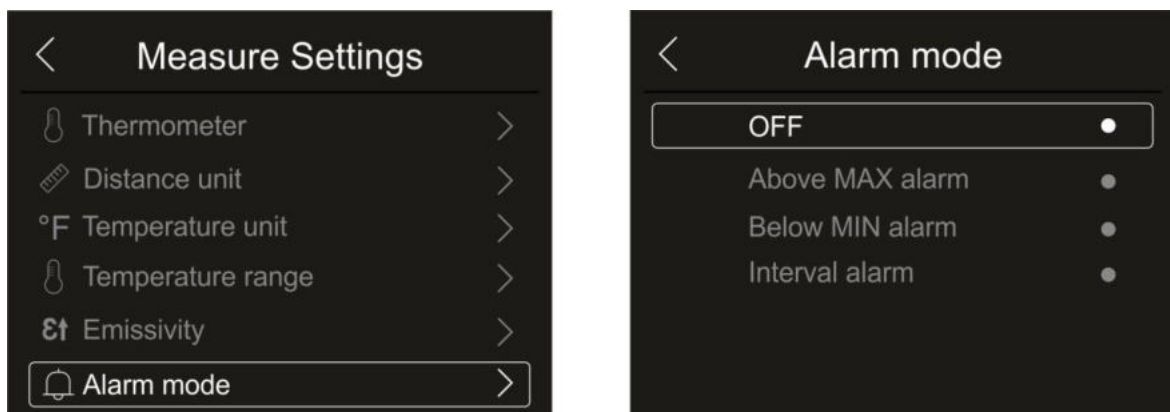

Fig. 26: Menu for Activation of alarm thresholds on measurements

2. Touch one of the following options: **OFF** (alarm deactivated), **Above MAX alarm** (active alarm for measured values exceeding the set threshold), **Below MIN alarm** (active alarm for measured values lower than the set threshold), **Interval alarm** (active alarm for measured values within the range between the set minimum and maximum thresholds).
3. Touch the arrow key “<” to quit and confirm.

### Section Image Align

In this section it is possible to align the IR image to the visible one shown on the display. These images could not be aligned due to the different position of the IR sensor and of the internal photo camera on the instrument.

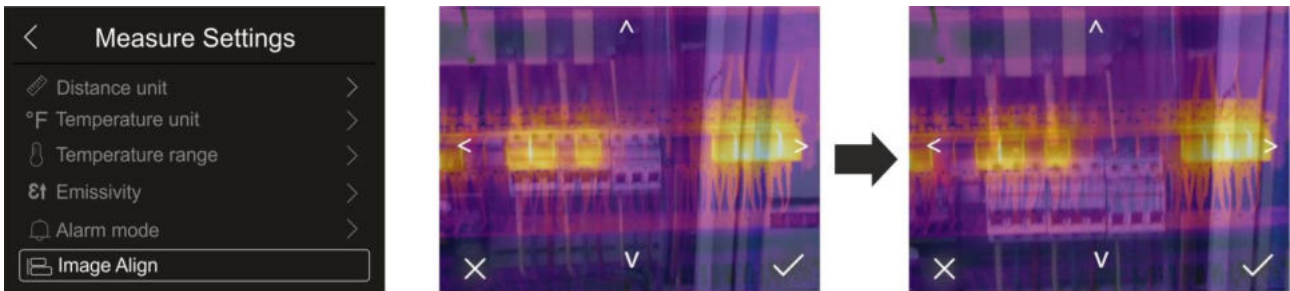

Fig. 27: Alignment of the image on the display

1. Touch the item “Image Align”. Fig. 27 – middle is shown on the display. In this figure, the two images with a low infrared value are overlapping.
2. Touch the 4 arrows on the display in order to move the IR image by overlapping it onto the visible one (see Fig. 27 – right side).
3. Touch the icon “✓” to confirm or icon “X” to quit without changes.

#### 5.3.1.3 Menu “Reset”

In this section, it is possible to delete the content of the internal memory or of the inserted micro SD card and restore the instrument's default conditions. Touch the screen to activate/deactivate the desired options.

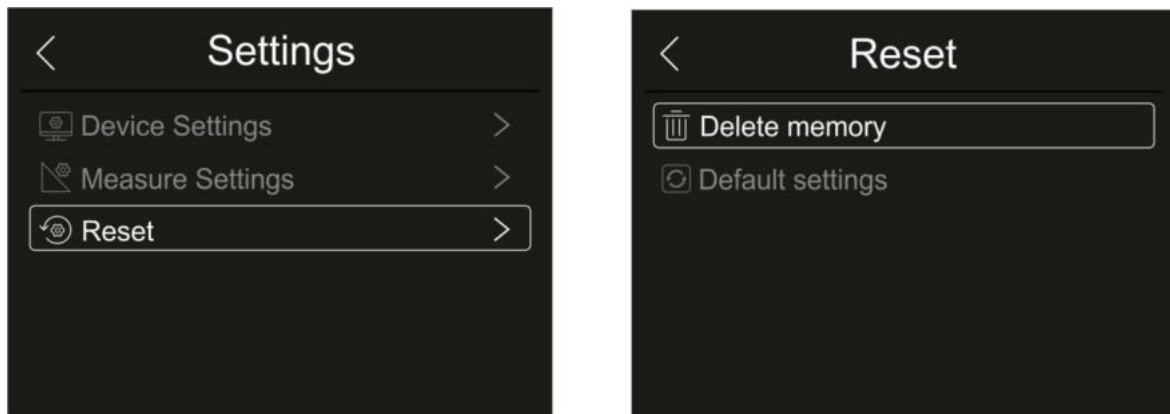

Fig. 28: Instrument reset menu

1. Touch the item “Reset”. The screen in Fig. 28 – right side appears on the display. Touch the item “Delete memory”. The following confirmation screen is displayed:

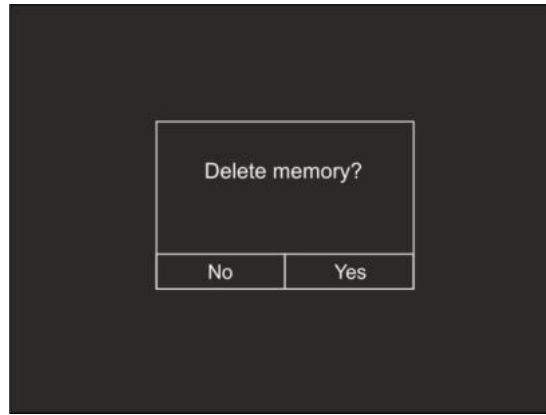

Fig. 29: Confirm memory deletion

2. Touch the option “Yes” to confirm deletion, or option “No” to cancel the operation and go back to the previous screen.
3. Touch the item “Default settings”. The following confirmation screen is displayed:



Fig. 30: Default settings

4. Touch the option “Yes” to confirm deletion, or option “No” to cancel the operation and go back to the previous screen. The default conditions of the instrument are reported in the following

Menu	Parameter	Value
Measurement	Central measuring cursor	OFF
	Cursor “hot” spot	OFF
	Cursor “cold” spot	OFF
Measuring parameters	Emissivity	0.95
	Reflected temperature	25°C
Image	Mode	IR
	Palette	Iron
	Image adjustment	Auto
System settings	Language	English

Table 2: Parameters' default values

### 5.3.2 Measurement Menu

Within this menu, it is possible to enable/disable different objects on the image, in order to prepare an advanced analysis of the temperature measurement. The instrument is provided with:

- 1 fixed cursor in a central position
- Max 3 spots, which can be freely placed onto the image
- 2 cursors for the detection of “hot” and “cold” spots of the image
- Max 3 dynamic measuring areas
- Max 2 dynamic horizontal and vertical lines
- Face mode to detect face temperature

1. Touch the screen or press key **MENU/OK** to enter the main menu.



2. Touch the icon “

Fig. 31: Measurement Menu

3. The following functions can be mutually used (each one excludes the other):

	<p style="text-align: center;"><b>Central spot</b></p> <ul style="list-style-type: none"> <li>➤ Touch the icon “ </li></ul>	<p style="text-align: center;"><b>3 mobile cursors</b></p> <ul style="list-style-type: none"> <li>➤ Touch the icon “ <p>EN - 25</p> </li></ul>
--	---	--

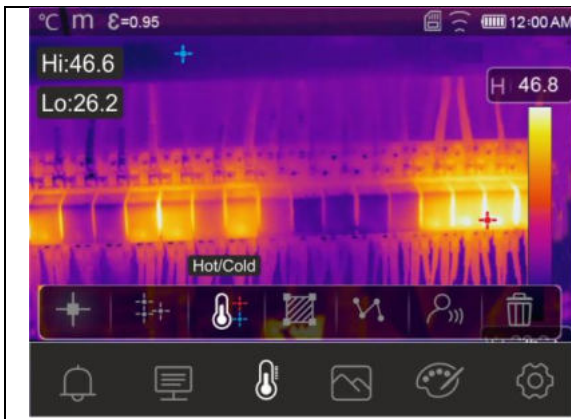

### Cursors for “hot” and “cold” spots

- Touch the icon “” to activate the dynamic cursors indicating the “hottest” (red) and “coldest” (blue) spots of the image.
- The temperatures associated with the dynamic cursors (Hi and Lo) is shown in the top left-hand part of the display.
- Touch the icon “” to remove the cursors.



### Area Cursors

- Touch the icon “” to activate the mobile cursor A1 indicating a closed area, which can be freely modified and dragged on the display. Touch the icon repeatedly to activate the other mobile cursors indicated as A2 and A3.
- The temperatures MIN, MAX, AVG (average) of the spots inside the area are shown in the top left-hand part of the display.
- Touch the icon “” to remove the area.

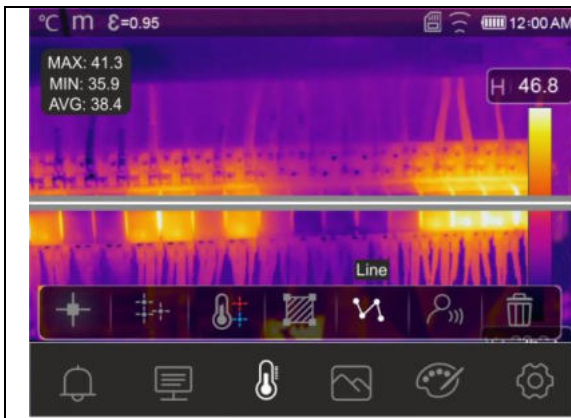

### Line Cursors

- Touch the icon “” to activate the horizontal line mobile cursor which can be freely dragged on the display. Touch the icon a second time to activate the vertical line cursor. The display shows the dynamic trend of temperature.
- The temperatures MIN, MAX, AVG (average) of the spots on the line are shown in the top left-hand part of the display.
- Touch the icon “” to remove the line.

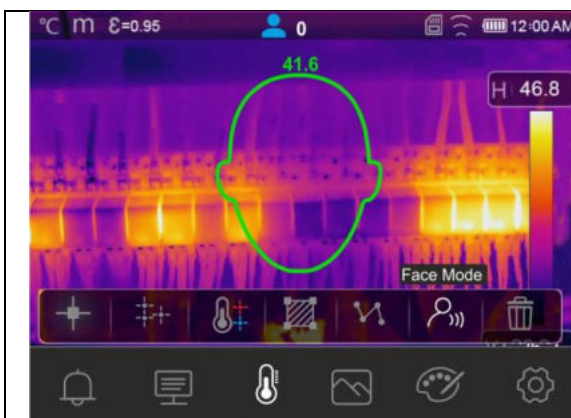

### Face mode

- Touch the icon “” to activate the “Face mode”, which allows measuring the maximum face temperature of a person who must be framed within the area shown on the display.
- The face area automatically becomes rectangular as shown in Fig. 32.
- Touch the icon “” to remove the area.



Fig. 32: Indication of Face mode

4. The Face mode is linked to the setting of the alarm condition above threshold (see § 5.3.1.2) and to the value of the maximum threshold set (see § 5.3.6).
5. If the face temperature of the framed person is **lower** than the set threshold, it will be shown **green** in the top part of the shown area (see Fig. 32 – middle).
6. If the face temperature of the framed person is **higher** than the set threshold, it will be shown **red** in the top part of the shown area (see Fig. 32 – right side).
7. The Face mode allows for the face temperature of several people (**up to 10 people**) to be evaluated at the same time (see Fig. 33). The counter “” found at the top of the display indicates the number of statistically valid detections.



Fig. 33: Face mode on more people

### 5.3.3 Menu Image and Zoom

In this menu it is possible to select the type of image displayed and to zoom in and out the image. The following options are available:

- **Thermal** → Display of the IR image only
- **Visible** → Display of the visible image only
- **Fusion** → Display of the IR image within the visible image (PiP feature)
- **Visible and Thermal** → Display IR and visible image divided into half the screen
- **Auto Fusion** → In this display mode, the instrument automatically mixes the infrared and the visible part of the image
- **Zoom** → it is possible to activate an electronic zoom **x1 ÷ x32**

1. Touch the screen or press key **MENU/OK** to enter the main menu.
2. Touch the icon “” to enter the “Image” menu. The following screen appears on the display:

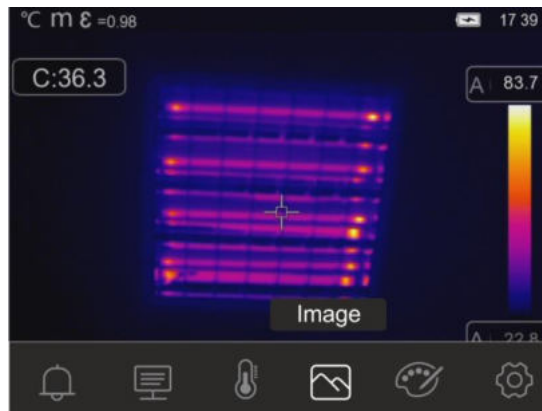

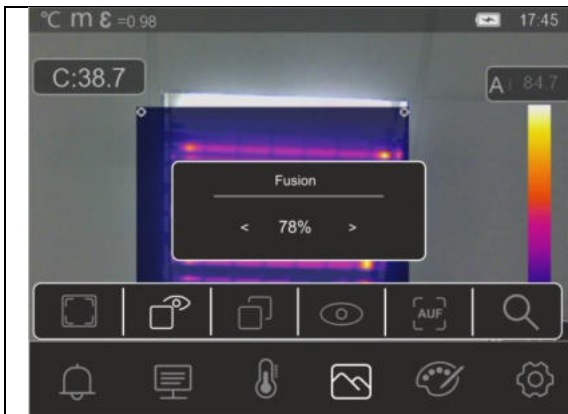



Fig. 34: Image menu

3. The following options can be selected:

	<p style="text-align: center;"><b>Thermal image</b></p> <p>Touch the icon “” to display the IR thermal image</p>



### Fusion image (Picture in Picture)

- Touch the icon “” to display the Fusion image (IR within the visible image).
- Use the arrow keys ◀ or ▶ or touch the arrow icons found in the “Fusion” box to adjust the IR level percentage
- Drag the IR frame into the visible image for a possible alignment.

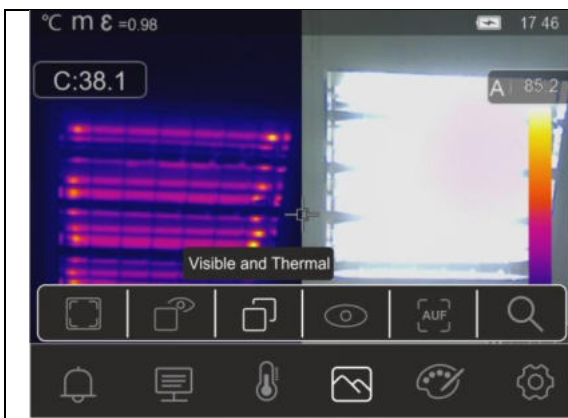

### Visible & Thermal image

- Touch the icon “” to display the thermal and visible image at the same time.
- The two images are shown on the screen divided into two halves.

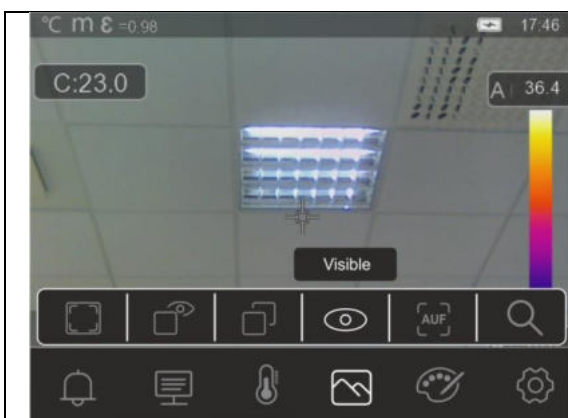

### Visible image

- Touch the icon “” to display the visible image.

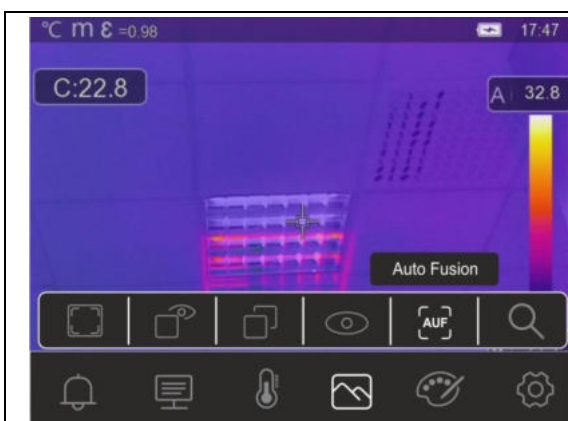

### AUF image (Auto Fusion)

- Touch the icon “” to display the image in “Auto Fusion” mode.
- In this display mode, the instrument compares the temperature in the middle of the display with the temperatures of the whole framed image, in order to automatically determine the mix between the infrared and the visible part. This function allows producing clearer printouts of the saved image.

4. Touch the icon “” to activate the electronic Zoom of the image. The following screen appears on the display.



Fig. 35: Activating image zoom

5. Press the arrow keys or or touch the scroll bar to increase/decrease the zoom level in the range  $1.0x \div 32.0x$  by steps of  $0.1x$  and observe the result on the display. The zoom value is shown at the top of the display (see Fig. 6 – part 4).
6. Set the value back to 1.0 to go back to the original size of the image.



### CAUTION

The image obtained through the zoom **CANNOT** be saved in the instrument's memory

#### 5.3.4 Menu Palette and isotherm lines' functions

In this menu, it is possible to select the type of color palette associated with the IR image and define the parameters of the isotherm line function.

1. Touch the screen or press key **MENU/OK** to enter the main menu.
2. Touch the icon “” to enter the “Palette” menu. The screen in Fig. 36 – right side appears on the display.



Fig. 36: Selection of color palettes and isotherm lines' functions

3. Touch the icon corresponding to the desired color palette, which will be automatically changed on the display. The following options are available:

Iron	Rainbow	Grey scale	Grey Inverted	Brown hot	Blue/Red	Hot/Cold	Feather

4. Touch the icon “” to activate the isotherm line function “Alarm high Temp.”. The following screen appears on the display:

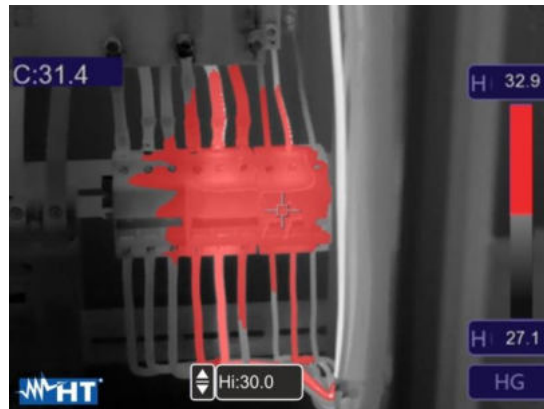

Fig. 37: Selection of isotherm line Alarm high Temp

5. Touch the “Hi” field at the bottom of the display and use the arrow keys ▲ or ▼ to set the value of the **maximum** temperature threshold above which the instrument shows image spots in red color, and the remaining spots in grey color (see Fig. 37).
6. Touch the icon “” to activate the isotherm line function “Alarm low Temp.”. The following screen appears on the display:

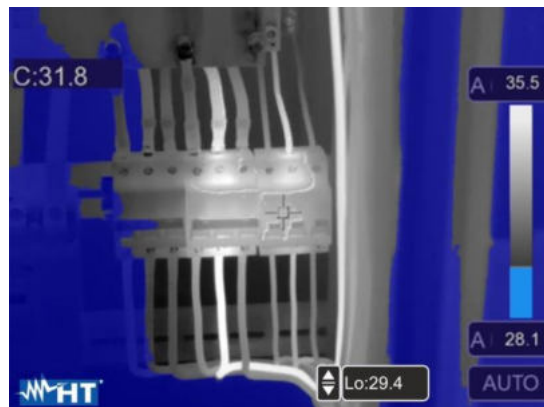

Fig. 38: Selection of isotherm line Alarm low Temp.

7. Touch the “Lo” field at the bottom of the display and use the arrow keys ▲ or ▼ to set the value of the **minimum** temperature threshold below which the instrument shows image spots in blue color, and the remaining spots in grey color (see Fig. 38).
8. Touch the icon “” to activate the isotherm line function “Alarm Temp. range”. The following screen appears on the display:

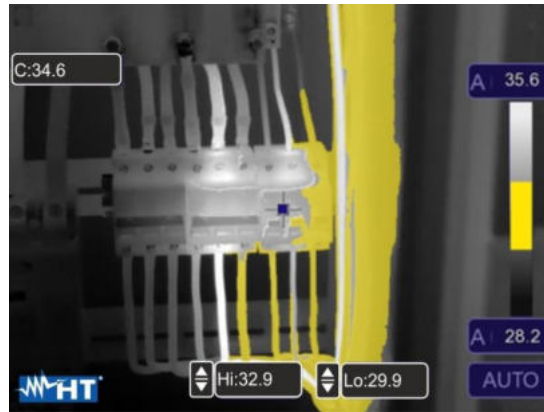

Fig. 39: Selection of isotherm line Alarm Temp. range

9. Touch the “Hi” and “Lo” field at the bottom of the display and use the arrow keys ▲ or ▼ to set the value of the **maximum** and **minimum** temperature threshold. The instrument shows the image spots with temperature between the “Lo” and the “Hi” threshold in orange color, and the remaining spots in grey color (see Fig. 39).
10. Touch the icon “⊙” to activate the isotherm line function “Visible range”. The following screen appears on the display:

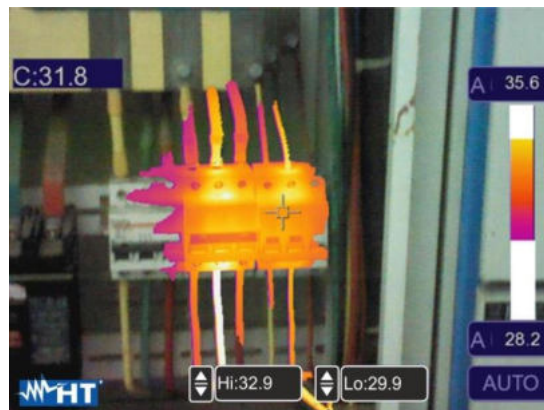

Fig. 40: Selection of Visible range

11. Touch the “Hi” and “Lo” fields at the bottom of the display and use the arrow keys ▲ or ▼ to set the value of the **maximum** and **minimum** temperature threshold. The instrument shows as radiometric IR image the spots with a temperature between the “Lo” and the “Hi” threshold, and as a visible image the spots with a temperature outside that range (see Fig. 40).



### CAUTION

The isotherm lines' functions can be used only with the instrument set to Normal measuring mode (see § 5.3.1.2)

### 5.3.5 Menu Parameters

In this menu it is possible to set the value of the following correction parameters, necessary for a correct temperature measurement to be performed by the instrument:

- Material emissivity → see § 5.3.1.2
- Ambient temperature
- Reflection temperature
- Relative humidity
- Temperature compensation (offset)
- Distance from target

#### **Parameters reflection temperature and ambient temperature**

Objects with a low emissivity may reflect infrared energy coming from adjacent objects; this energy is added to the energy of the object itself, thus causing possible measurement mistakes. In several situations, there are sources of heat with a higher temperature than the temperature found near the object being measured. In this case, it is necessary to compensate this reflected energy by entering the presumed temperature value of the adjacent heat source into the thermal camera. In most of the applications, the reflection temperature is identical to the ambient temperature and has negligible effects on temperature measurement on objects with a high emissivity.

Ambient temperature → which can be set within the range: **-10°C ÷ 50°C**

Reflection temperature → which can be set within the range: **0.0°C ÷ 650.0°C** (THT100, THT200, THT300)

Reflection temperature → which can be set within the range: **0.0°C ÷ 550.0°C** (THT400)

#### **Parameter Temperature compensation (Offset)**

This parameter can be set if, in automatic mode, you are sure of the values which the temperature levels associated with the color palette must take (see § 5.4). In this case, the levels are increased or decreased by the quantity inserted in that field.

Offset → which can be set within the range: **-5.0°C ÷ 5.0°C**

#### **Parameter Distance**

This parameter identifies the distance between the thermal camera and the object to be measured. In most of the applications, the temperature levels associated to the color palette (see § 5.4) are influenced negligibly by small variations of distance. Therefore, it is possible to leave this parameter set to the default value without having significant errors on measurement. For distances higher than 300m it is possible to have variations > 1°C in temperature level.

Distance → which can be set within the range: **0m ÷ 2000m**

#### **Parameter Relative humidity**

This parameter identifies the value of relative humidity of the environment where measurement is carried out. In most of the applications, the temperature levels associated to the color palette (see § 5.4) are influenced negligibly by small variations of humidity. Therefore, it is possible to leave this parameter set to the default value without having significant errors on measurement.

Relative humidity %RH which can be set within the range: **0% ÷ 100%**

1. Touch the screen or press key **MENU/OK** to enter the main menu.
2. Touch the icon “” to enter the “Parameters” menu. The following screens are shown on the display:

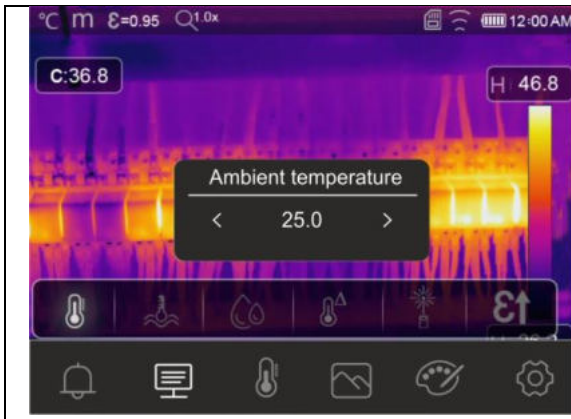

### Ambient Temp. setting

- Touch the icon “” to open the section of which to define ambient temperature. The screen to the side appears on the display.
- Use the arrow keys ◀ or ▶ or touch the arrow icons found in the “Ambient temperature” box to set the value.
- Touch the screen to quit the section.



### Reflection Temp. setting

- Touch the icon “” to open the section of which to define reflection temperature. The screen to the side appears on the display.
- Use the arrow keys ◀ or ▶ or touch the arrow icons found in the “Reflection temperature” box to set the value.
- Touch the screen to quit the section.



### Relative humidity setting

- Touch the icon “” to open the section of which to define relative temperature. The screen to the side appears on the display.
- Use the arrow keys ◀ or ▶ or touch the arrow icons found in the “Relative humidity” box to set the value.
- Touch the screen to quit the section.

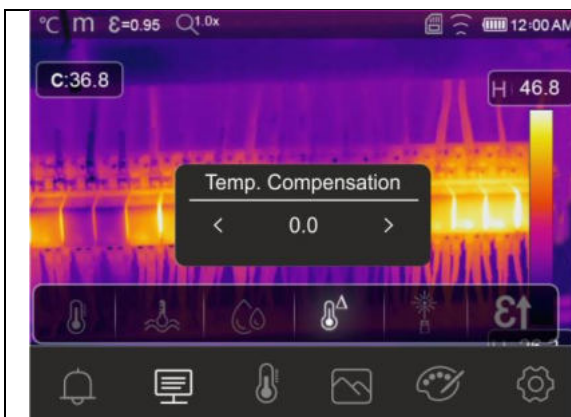

### Temp. compensation setting

- Touch the icon “” to open the section of which to define temperature compensation. The screen to the side appears on the display.
- Use the arrow keys ◀ or ▶ or touch the arrow icons found in the “Temp. Compensation” box to set the value.
- Touch the screen to quit the section.



### Distance setting

- Touch the icon “

### Emissivity setting

- Touch the icon “
 EN - 35

### 5.3.6 Alarm menu

In this section, it is possible to set the high and low threshold values the instrument takes into consideration to activate the acoustic alarm on temperature measurements.



#### CAUTION

This function can only be used after activating the alarm condition in the “Settings” menu (see § 5.3.1.2)

1. Touch the screen or press key **MENU/OK** to enter the main menu.
2. Touch the icon “” to enter the “Alarm” menu. The following screens are shown on the display:

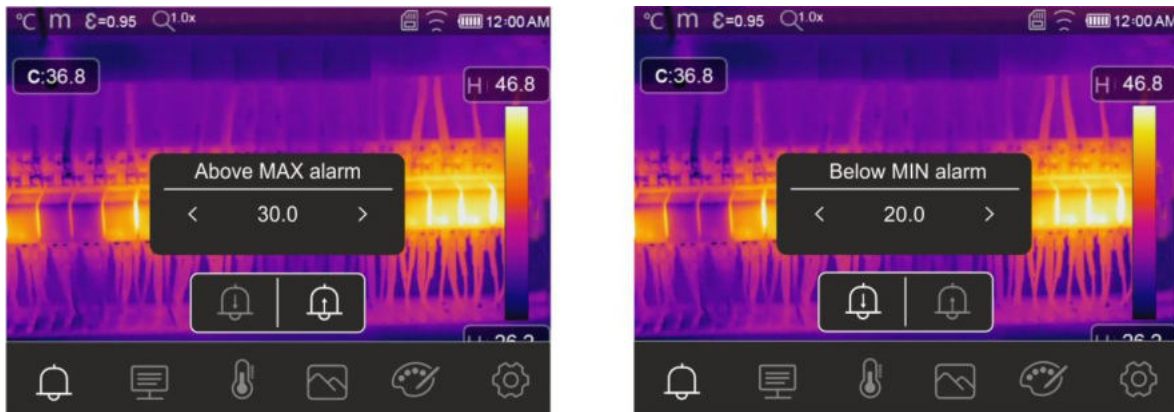



Fig. 41: Setting of limit thresholds on alarms

3. Touch the icon “” to define the **high** threshold value associated with the alarm. The screen in Fig. 41 – left side appears on the display.
4. Use the arrow keys ◀ or ▶ or touch the arrow icons found in the “Above MAX alarm” box to set the value according to the measuring range set on the instrument. The instrument will sound for measured temperature values above the set threshold.
5. Touch the icon “” to define the **low** threshold value associated with the alarm. The screen in Fig. 41 – right side appears on the display.
6. Use the arrow keys ◀ or ▶ or touch the arrow icons found in the “Below MIN alarm” box to set the value according to the measuring range set on the instrument. The instrument will sound for measured temperature values below the set threshold.

## 5.4 ADJUSTING THE IMAGE TEMPERATURE

The instrument allows adjusting the temperature associated with the framed image on the display (levels high, low and span) as follows:

- **Automatic (AUTO)** mode → the minimum and maximum temperature levels of the framed object on the display and associated with the color palette are automatically defined by the instrument and dynamically vary when moving it. This (default) option, which can be used in most cases, allows for an optimum display of the IR image. The relationship between temperature and color of the palette is **linear**.
- **Histogram (HG)** mode → the minimum and maximum temperature levels of the object framed on the display are always defined automatically by the instrument, as in the Auto mode, but in this case, the areas of the image in which temperature values are very different from the values of adjacent areas are highlighted. The relationship between temperature and color of the palette is **non-linear** according to a histogram algorithm. This mode emphasizes image display in very dark working environments.
- **Manual (MANUAL/LOCK)** mode → the minimum and maximum temperature level of the framed target on the display are manually set by the user. This mode, particularly useful to clearly identify only some areas of the image, is recommended in case of advanced thermographic operations.

1. Press key or touch the icon “AUTO” found at the bottom on the right side of the display. The screens in Fig. 42 show the selection of modes “AUTO” and “HG”.

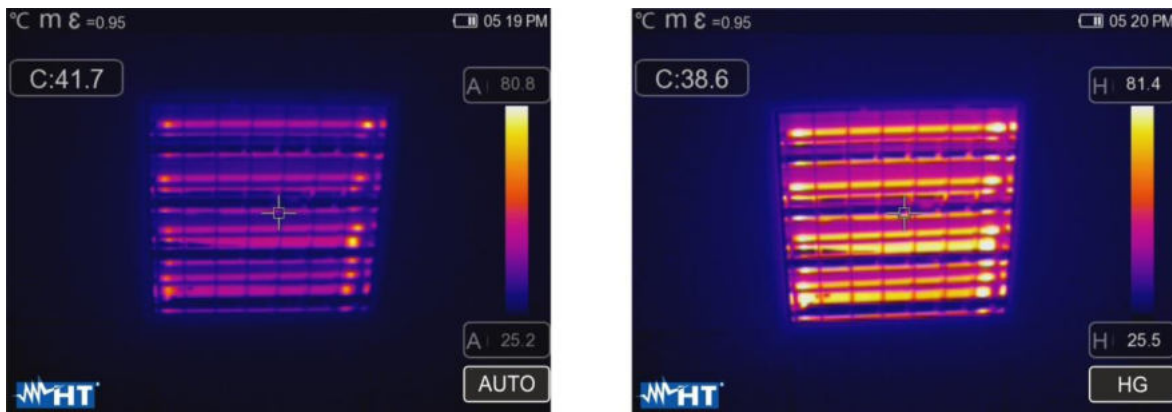





Fig. 42: Setting the Automatic and Histogram modes

2. Press key or touch the icon “AUTO” by selecting the “MANUAL” option. The following screens are shown on the display:



Fig. 43: Setting the Manual mode

3. Use the arrow keys ▼ or ▲ to set the temperature values associated with the high and low levels by steps of 0.1°C at the same time (see Fig. 43 – left side).

4. Touch the icon “” near the levels to block the set temperature values.
5. Use the arrow keys ▼ or ▲ to set the temperature value associated with the high level by steps of 0.1°C (see Fig. 43 – middle).
6. Touch the icon “” to block the set temperature value.
7. Use the arrow keys ▼ or ▲ to set the temperature value associated with the low level by steps of 0.1°C (see Fig. 43 – right side).
8. Touch the icon “” to block the set temperature value.

## 5.5 SAVING IR IMAGES AND VIDEOS

The instrument is capable of saving both IR images and videos in the internal memory or on the inserted micro SD card. Each image is automatically saved in a **JPG** (snapshot) and **HIR** format (which can only be opened via the software THTLink – see § 6). IR videos are saved in a standard MP4 format. The following operations are possible:

- Fixing the images on the display
- Saving the images in the instrument's memory
- Adding text annotations when saving the image
- Changing the image parameters upon saving

### 5.5.1 Image saving

An IR image on the display may be saved after it has been frozen on the display. Proceed as follows:

1. Press the **T** (Trigger) key to freeze an IR image on the display. The following screen appears on the display:

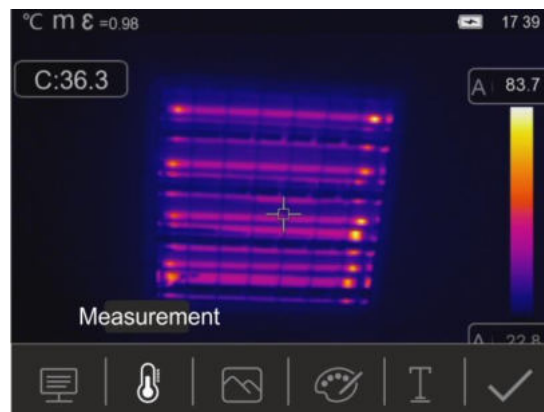

Fig. 44: Image saving

2. Touch the icon “✓” or press again the **T** key to confirm saving the image, if no change needs to be made to it. Touch the display to unfreeze the IR image
3. In case it is necessary to change the image parameters, touch the corresponding icons “☰”, “🌡️”, “🖼️” and “⚙️”, follow the procedures described in the previous chapters and touch the icon “✓” to confirm.
4. Touch the icon “📄” to add a text annotation to the image. The screen in Fig. 45 – right side appears on the display.

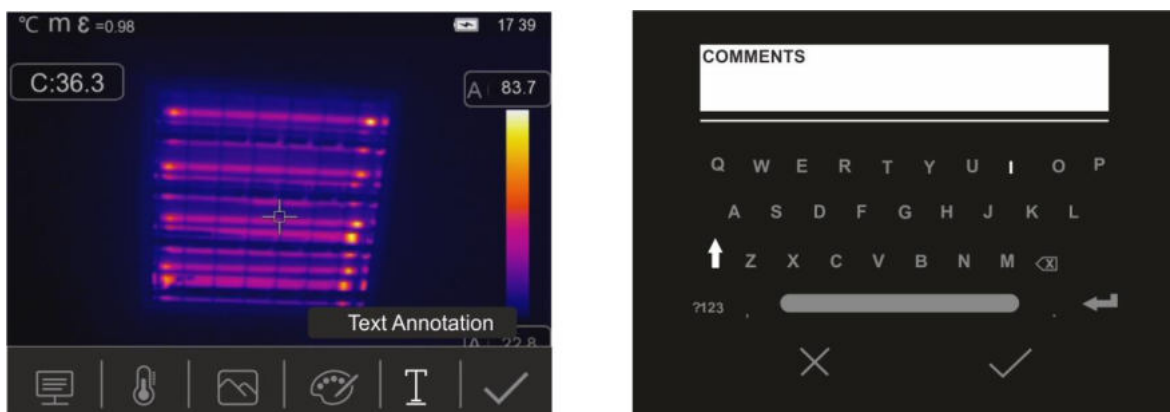

Fig. 45: Adding a text annotation to the image

5. Insert the text comment by using the virtual keyboard and confirm with “✓” or touch “X” to go back to the previous screen.
6. Confirm saving the image with the text annotation by touching the icon “✓”.

### 5.5.2 Recording IR videos

The instrument allows recording and saving also IR videos without audio in a MP4 format, as follows:

1. **Press and hold key T (Trigger) for at least 2s.** The “REC” indication and the elapsed time are shown at the top of the display to indicate that recording is in progress (see Fig. 46 – left side).

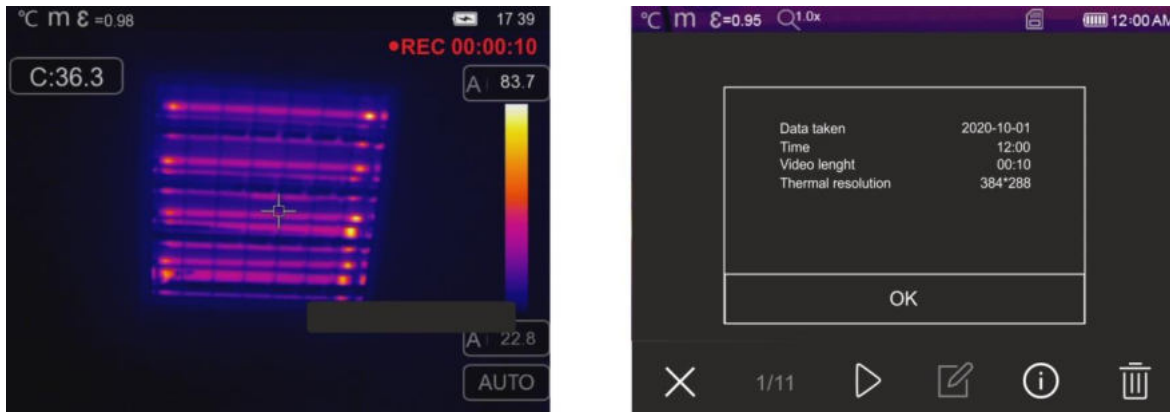

Fig. 46: IR video recording

2. Press key T (Trigger) to stop and automatically save the recording in the instrument's memory. Touch the icon “i” to open the section containing the information about the saved video

### 5.5.3 Gallery menu

In this section it is possible to recall and display the gallery of IR images and videos saved in the instrument's menu or on the inserted micro SD card. In the same section it is possible to see the text annotations made while saving the images.

1. Press key to enter the gallery of the images and videos saved in the instrument's memory or on the micro SD card. The following screen in Fig. 47 – left side is shown on the display

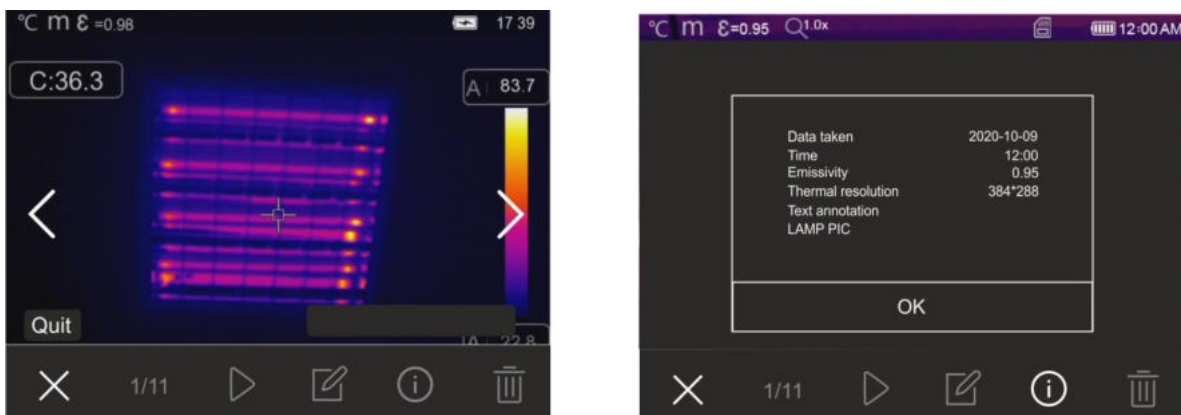

Fig. 47: Recalling on the display the images saved

2. Use the arrow keys ► or ◀ or touch the icons “<” or “>” to recall the desired image on the display.
3. Touch the icon “i” to open the section containing the information about the saved image. The screen in Fig. 47 – right side appears on the display.
4. Touch the icon “▶” to play a possible saved IR video.
5. Touch the icon “✎” to display the icons “☰”, “🔧”, “✉” and “👁” to make changes on the image recalled on the display. Touch the icon “✓” to confirm the changes made, by overlapping the modified image or saving a copy.
6. Touch the icon “X” to quit without saving or to go back to the main menu.
7. Touch the icon “🗑” to delete the image recalled on the display.

## 5.6 CHARACTERISTICS OF THE LENS

The instrument is provided with a 9mm focus lens (THT300), 7.5mm (THT200,THT100) or 13.5mm (THT400). The theory of operation is reported below, based on the 9mm lens.

### Definitions

- **FOV (Field Of View)** → Visible range → represents the maximum angular opening (expressed in degrees) the instrument is capable of managing at a certain distance.
- **IFOV (Instantaneous Field Of View)** → represents the smallest detail within the FOV, that the instrument can detect at a certain distance. It is expressed in radians by the following formula:

$$\text{IFOV (theoretical)} = (\text{size of sensor's pixels}) / (\text{focus length of the lens})$$

- **D:S ratio** → Ratio Distance / Cross-section of the target object → it provides information on the maximum distance between the instrument and the target having a certain cross-section (spot) in order to obtain correct temperature measurements. It is expressed as:

$$\text{D:S (theoretical)} = 1 / \text{IFOV (theoretical)}$$

### Case of instrument THT300

FOV = 41.5° (Horizontal) x 31.1° (Vertical)

Focus lens = 9mm

Size of sensor's pxls = 17µm

IFOV (theoretical) = 17µm / 9mm = 1.89mrad

D:S (theoretical) = 1 / IFOV (theoretical) = 529:1

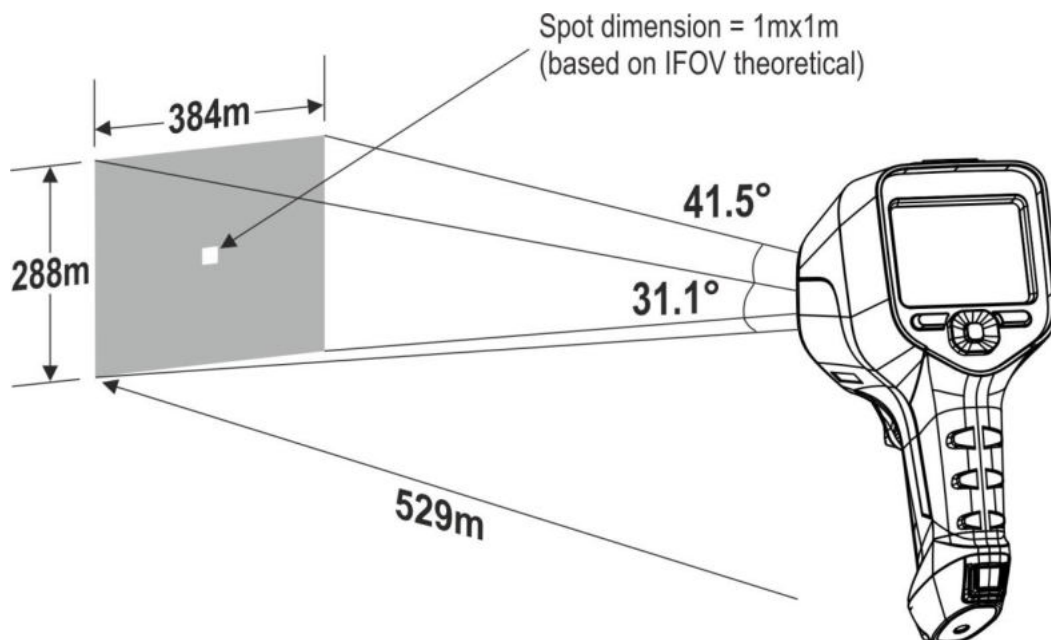

Fig. 48: Representation of the instrument's field of view FOV

- Typically, the IFOV parameter (real) is always considered as approx. 3 times higher than the theoretical one, therefore the D:S ratio (real) is approx. 3 times lower than the theoretical one. This means that, for THT300: **D:S (real) ~ 176:1**

## 5.7 USE OF THE SCREENING MODE

1. Switch on the instrument.
2. Set the emissivity parameter to a value between **0.95** and **0.98** (typically 0.95).
3. Activate the “Screening” mode (see § 5.3.1.2).
4. Activate the alarm condition (see § 5.3.1.2) and set the maximum temperature threshold associated with one of the measuring cursors (see § 5.3.6).
5. Activate the Face mode (see § 5.3.2).
6. Select the desired color palette (Iron or Grey scale recommended – see § 5.3.4).
7. Select the AUTO measuring mode (see § 5.4).
8. Correctly focus the item to be tested (see § 5.2).
9. Frame the item to be tested at a distance of max 2m.
10. The following screen appears on the display.

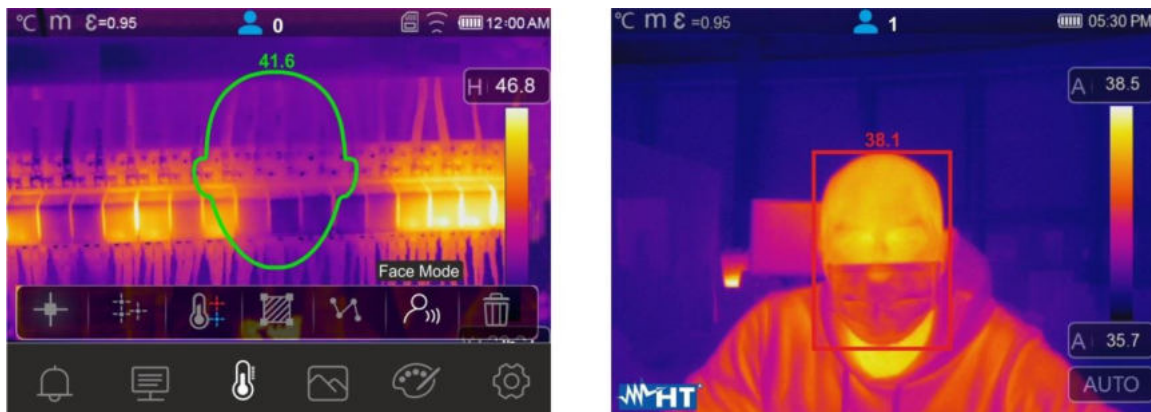

Fig. 49: Display of the alarm condition in Screening function

### CAUTION



- The Screening function allows measuring the temperature of the human body, but the instrument **CAN IN NO WAY be used as a medical device.**
- Temperature measurement with the Screening function **cannot replace medical evaluation.**

## 6 USING THE THTLINK SOFTWARE

The software “THTLink” can be used to analyse the images saved in the instrument's memory.

### 6.1 MINIMUM SYSTEM REQUIREMENTS

Hardware: PC 3.70Ghz 32bit/64 bit  
RAM memory: 8GB  
Output interface: USB ports or SD card reader  
Screen resolution: 1920x1080  
Operating system: Windows 7 or higher  
Software applications: Microsoft .Net Framework 4.0

### 6.2 INSTALLING THE THTLINK SOFTWARE

1. Download the THTLink software from [www.ht-instruments.com/download](http://www.ht-instruments.com/download) website
2. Launch file “THTLink\_setup.exe” and follow the guided installation procedure.

### 6.3 MAIN CHARACTERISTICS OF THE THTLINK SOFTWARE

IR images (with HIR format) can be opened with the software, as shown in the following Fig. 50.

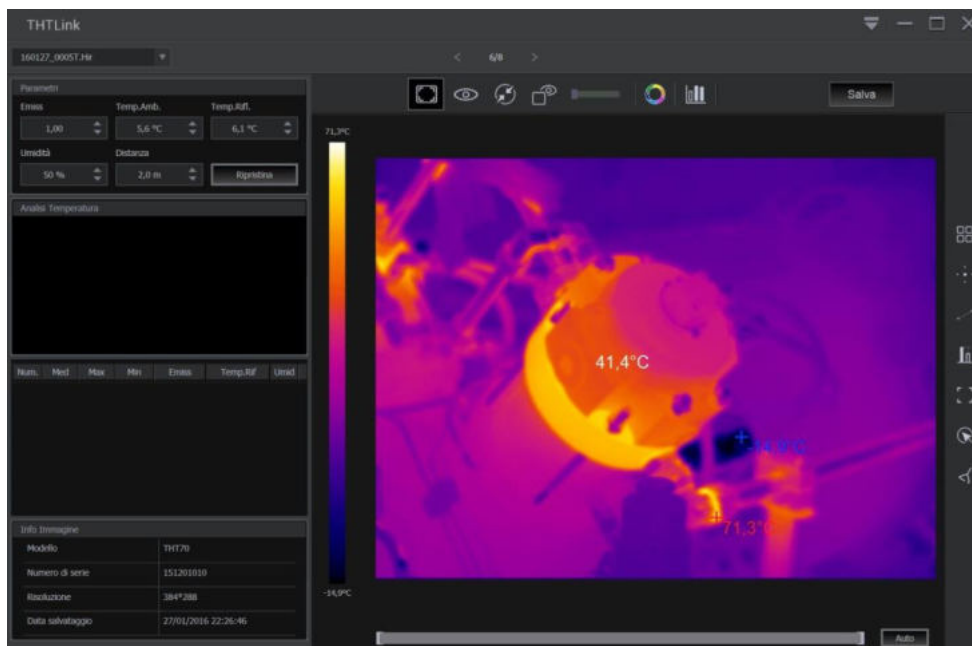

Fig. 50: Image display with the THTLink software

#### Main characteristics of the THTLink software:

- Display of IR, visible, Fusion, PiP images
- Insertion of advanced analysis tools (spots, lines, areas, deltaT, isotherm lines)
- Realization of graphs from IR images
- Realization of print reports
- Playback of the text annotations saved on the images

- **For information about the use of THTLink, please refer to the Help on line of the software itself**
- **THTLink software is downloadable from [www.ht-instruments.com/download](http://www.ht-instruments.com/download) website**

## 7 MAINTENANCE

### 7.1 GENERAL INFORMATION

While using and storing the instrument, carefully observe the recommendations listed in this manual in order to prevent possible damage or danger during use. Do not use the instrument in environments with high humidity levels or high temperatures. Do not expose to direct sunlight. Always switch off the instrument after use.

### 7.2 RECHARGING THE INTERNAL BATTERY

The instrument is designed to be supplied with a Li-ION rechargeable battery. With symbol “” shown on the display, it is necessary to recharge the battery. Recharge can be performed as follows:







- By connecting the instrument to the electric mains through the battery charger provided with the instrument
- Insert the battery into the recharging base (optional accessory **THTCBM**) and connect it to the electric mains.



#### CAUTION

- Recharge the battery at an environmental temperature between **0°C and 50°C (32°F and 122°F)**. With a temperature outside this range, the battery may overheat or break and, at any rate, reduce its life cycle.
- The battery must not be removed from the instrument while recharging.
- When using the instrument for the first time, recharge the battery for at least **3 hours**.

#### Recharging the battery with direct connection to the electric mains

1. Connect the provided battery charger to the AC electric mains and the output to the instrument's micro USB port (see Fig. 3 – Part 2).
2. With the instrument turned off, the indicator of the battery charge level takes the flashing symbols “     ” in a sequence.
3. When the symbol “” appears steady on the display, the charging process is complete (see Fig. 51).

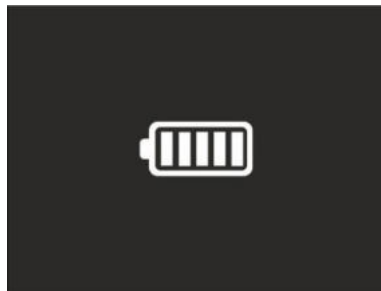



Fig. 51: Indication of complete recharge of the battery

4. With the instrument turned on, the symbol “” is shown on the display.
5. Disconnect the battery charger from the instrument and from the electric mains.

#### Recharging by connection to the recharging base

1. Connect the provided battery charger to the AC mains and the provided recharging base. The green “**PWR**” LED on the base turns on.
2. Insert the battery into the recharging base. The red “**CHG**” LED on the base turns on.
3. Carry on the recharging process until the “**CHG**” LED turns off.
4. Remove the battery, disconnect the recharging base and the battery charger from the electric mains.

### 7.3 CLEANING THE INSTRUMENT

Use a soft and dry cloth to clean the instrument. Never use wet cloths, solvents, water, etc.

### 7.4 END OF LIFE



**WARNING:** this symbol found on the instrument indicates that the appliance, its accessories and the batteries must be collected separately and correctly disposed of.

### 7.5 ACCESSORIES

#### 7.5.1 Accessories provided

- Built-in focal lens for IR measurements  $f=9\text{mm}$  (THT300),  $f=7.5\text{mm}$  (THT200, THT100)
- Built-in focal lens for IR measurements  $f=13.5\text{mm}$  (THT400)
- Lens protection cap
- Rechargeable Li-ION battery, 3.7V 2600mAh Cod. THTBATM
- AC/DC 100-240V/5V adapter + universal plugs
- Micro SD card, 16GB
- Adapter for micro SD card
- USB-C cable
- ISO test report
- Quick user guide
- Transport soft bag (THT100, THT200, THT300)
- Rigid transport case (THT400)

#### 7.5.2 Accessories optional

- Recharging base Cod. THTCBM
- Set of recharging base + Li-ION battery Cod. THTBATKITM

## 8 TECHNICAL SPECIFICATIONS

### Temperature measurement (THT100, THT200, THT300)

Range	Resolution	Accuracy (*)
-20.0°C ÷ 650.0°C	0.1°C	±2% lettura o ±2°C (valore maggiore)
-4.0°F ÷ 1202.0°F	0.1°F	±2% lettura o ±3.6°F (valore maggiore)

(\*) Environmental temperature: 10°C ÷ 35°C, Temperature of target: >0°C

### Temperature measurement (THT400)

Range	Resolution	Accuracy (*)
-20.0°C ÷ 550.0°C	0.1°C	±2% lettura o ±2°C (valore maggiore)
-4.0°F ÷ 1022.0°F	0.1°F	±2% lettura o ±3.6°F (valore maggiore)

(\*) Environmental temperature: 10°C ÷ 35°C, Temperature of target: >0°C

### Temperature measurement in Screening mode

Range	Resolution	Accuracy
32.0°C ÷ 42.0°C	0.1°C	±0.5°C
89.6°F ÷ 107.6°F	0.1°F	±0.9°F

### General specifications

Type of IR sensor / Resolution:	UFPA (384x288pxl, 17µm) (THT300) UFPA (160x120pxl, 17µm) (THT200) UFPA (80x80pxl, 34µm) (THT100) UFPA (640x480pxl, 17µm) (THT400)
Spectrum response:	8 ÷ 14µm
Field of view (FOV) / Lens / F:	41.5° x 31.1° / 9mm / 1.0 (THT300) 20.7° x 15.6° / 7.5mm / 1.0 (THT200) 21° x 21° / 7.5mm / 1.0 (THT100) 31.9° x 25.7° / 13.5mm / 1.0 (THT400)
I FOV:	1.89mrad (THT300) 2.26mrad (THT200) 4.53mrad (THT100) 1.26mrad (THT400)
Thermal sensitivity / NETD:	<0.05°C@30°C (86°F) / 50mK
Image frequency:	50Hz (THT100, THT200, THT300), 25Hz (THT400)
Focusing:	manual (THT300, THT200) automatic (THT100, THT400)
Minimum focus distance:	0.5m
Temperature readings:	°C, °F, K
Available color palettes:	8 palettes+ 4 isotherm lines
Electronic zoom:	x1.0 ÷ x32.0 in steps of 0.1
Emissivity correction:	0.01 ÷ 1.00 in steps of 0.01
Image adjustment modes:	Automatic / Manual / Histograms (HG)
Measuring functions:	corrections according to environmental temperature, reflected temperature, distance, relative humidity, offset.
Advanced analyses:	fixed central cursor spots (3), lines (2), areas (3), "Hot/Cold" cursors
Face temp. detection:	max 10 people at the same time (distance 2m)
Inbuilt photo camera:	2Mpxl, FOV 65°
Image modes:	IR, Visible, Fusion PiP, Auto Fusion
Alarm conditions:	visible and acoustic
Image format:	JPG (snapshots), HIR (radiometric)

IR video recording:	MP4 format (640x480 @ 30fps), >60min su SD card
Text annotation:	with virtual keyboard
Memory:	Internal (3.4GB) + microSD card 16GB (max 32GB)
No. of images/videos:	1000 photos/45min video (internal memory) >6000 photos (microSD card)
PC interface:	USB-C
Interface to mobile devices:	WiFi (with APP <b>HTProCamera</b> )

### **Power supply**

Internal supply:	rechargeable Li-ION battery, 3.7V 2600mAh
External supply:	adapter 100-240VAC (50/60Hz)/5VDC, 2400mA
Battery duration:	approx. 4 hours (stand-by and WiFi off)

### **Display**

Characteristics:	Color, TFT LCD 3.5", 640x480pxl capacitive touch-screen
------------------	--

### **Mechanical characteristics**

Size (L x W x H):	240 x 101 x 110mm (9 x 4 x 4in)
Weight (battery included):	535g (19ou) (THT300, THT200) 480g (17ou) (THT100, THT400)
Mechanical protection:	IP54 in compliance with IEC 529

## **8.1 ENVIRONMENT**

### **8.1.1 Environmental conditions for use**

Operating temperature:	-15°C ÷ 50°C (5°F ÷ 122°F)
Storage temperature:	-40°C ÷ 70°C (-40°F ÷ 158°F)
Allowable relative humidity:	10%RH ÷ 90%RH
Falling test:	2m
Shock:	25G in compliance with IEC60068-2-29
Vibrations:	2G in compliance with IEC60068-2-6

<p style="text-align: center;"><b>This instrument complies with Directive EMC 2014/35/EU This instrument satisfies the requirements of European Directive 2011/65/EU (RoHS) and 2012/19/EU (WEEE)</b></p>
---

## 9 ASSISTANCE

### 9.1 WARRANTY CONDITIONS

This instrument is warranted against any material or manufacturing defect, in compliance with the general sales conditions. During the warranty period, defective parts may be replaced. However, the manufacturer reserves the right to repair or replace the product. Should the instrument be returned to the After-sales Service or to a Dealer, transport will be at the Customer's charge. However, shipment will be agreed in advance. A report will always be enclosed to a shipment, stating the reasons for the product's return. Only use original packaging for shipment; any damage due to the use of non-original packaging material will be charged to the Customer. The manufacturer declines any responsibility for injury to people or damage to property.

The warranty shall not apply in the following cases:

- Repair and/or replacement of accessories and battery (not covered by warranty).
- Repairs that may become necessary as a consequence of an incorrect use of the instrument or due to its use together with non-compatible appliances.
- Repairs that may become necessary as a consequence of improper packaging.
- Repairs which may become necessary as a consequence of interventions performed by unauthorized personnel.
- Modifications to the instrument performed without the manufacturer's explicit authorization.
- Use not provided for in the instrument's specifications or in the instruction manual.

The content of this manual cannot be reproduced in any form without the manufacturer's authorization.

**Our products are patented and our trademarks are registered. The manufacturer reserves the right to make changes in the specifications and prices if this is due to improvements in technology.**

### 9.2 ASSISTANCE

If the instrument does not operate properly, before contacting the After-sales Service, please check the conditions of the batteries and replace them, if necessary. Should the instrument still operate improperly, check that the product is operated according to the instructions given in this manual. Should the instrument be returned to the After-sales Service or to a Dealer, transport will be at the Customer's charge. However, shipment will be agreed in advance. A report will always be enclosed to a shipment, stating the reasons for the product's return. Only use original packaging for shipment; any damage due to the use of non-original packaging material will be charged to the Customer.





**HT INSTRUMENTS SA**

C/ Legalitat, 89  
08024 Barcelona - **ESP**  
Tel.: +34 93 408 17 77, Fax: +34 93 408 36 30  
eMail: info@htinstruments.com  
eMail: info@htinstruments.es  
Web: www.htinstruments.es

**HT INSTRUMENTS USA LLC**

3145 Bordentown Avenue W3  
08859 Parlin - NJ - **USA**  
Tel: +1 719 421 9323  
eMail: sales@ht-instruments.us  
Web: www.ht-instruments.com

**HT ITALIA SRL**

Via della Boaria, 40  
48018 Faenza (RA) - **ITA**  
Tel: +39 0546 621002  
Fax: +39 0546 621144  
eMail: ht@htitalia.it  
Web: www.ht-instruments.com

**HT INSTRUMENTS GMBH**

Am Waldfriedhof 1b  
D-41352 Korschenbroich - **GER**  
Tel: +49 (0) 2161 564 581  
Fax: + 49 (0) 2161 564 583  
eMail: info@ht-instruments.de  
Web: www.ht-instruments.de

**HT INSTRUMENTS BRASIL**

Rua Aguaçu, 171, bl. Ipê, sala 108  
13098321 Campinas SP - **BRA**  
Tel: +55 19 3367.8775  
Fax: +55 19 9979.11325  
eMail: vendas@ht-instruments.com.br  
Web: www.ht-instruments.com.br

**HT ITALIA CHINA OFFICE**

**意大利HT中国办事处**  
Room 3208, 490# Tianhe road, Guangzhou - **CHN**  
地址：广州市天河路490号壬丰大厦3208室  
Tel.: +86 400-882-1983, Fax: +86 (0) 20-38023992  
eMail: zenglx\_73@hotmail.com  
Web: www.guangzhouht.com