

# InfiniiVision 3000T X-Series Oscilloscopes

## Touch, Discover, Solve

The InfiniiVision 3000A X-Series redefined oscilloscopes. It saw the most signal detail, provided more functionality than any other oscilloscope, and gave you maximum investment protection. It was also the most successful oscilloscope in Hewlett Packard, Agilent and Keysight Technologies, Inc.'s history. The 3000T X-Series continues that legacy.

The 3000T X-Series takes everything that was revolutionary about the A model and adds a capacitive touch screen, a user interface designed for touch, and the exclusive zone touch trigger, all combined with an industry-leading uncompromised update rate of 1 million waveform/sec to give you the confidence that you're seeing all of your signal detail, and the ability to discover any issues. And the addition of new analysis capabilities help you solve your hardest problems quickly.



# Table of Contents

- Touch, Discover, Solve ..... 1
- Touch: Designed-For-Touch Interface and Capacitive Touch Screen Simplify Use ..... 4
- Discover: The Industry’s Fastest Uncompromised Update Rate Increases the Chance of Finding Anomalies..... 9
- Discover: Excellent Signal Integrity Allows you to See More Signal Detail ..... 13
- Discover: Industry Exclusive Zone Touch Trigger Makes Triggering Simple ..... 14
- Discover: Standard Segmented Smart Memory Allows you to Capture Longer Periods of Time at High Sample Rates..... 16
- Discover: Dedicated Search and Navigation Helps you Navigate Deep Memory ..... 17
- Solve: Integrated Hardware-Based Serial Decoding and Triggering (Option) Makes Easy Work of Low Speed Serial Buses..... 18
- Solve: Segmented Smart Memory Combined with Protocol Analysis Enables Insights Over Long Periods of Time ..... 20
- Solve: Dedicated Frequency/Spectrum Analysis Allows you to Time-Correlate Analog, Digital, and Frequency Domain Signals in a Single Instrument..... 21
- Solve: Standard Advanced Math Capabilities Allow New Views of Signals ..... 24
- Solve: Class Leading Measurements Provide Quick Answers ..... 25
- Solve: 7-in-1 Integration Allows New Measurement Possibilities ..... 26
- Solve: Hardware Accelerated Mask Limit Testing and Measurement Limit Testing (Option) Makes It Easy to See the Performance of your Device ..... 31
- Solve: Integrated Power Measurements and Analysis (Option) Make Short Work of Power Measurements ..... 32
- Solve: Innovative Power Rail Probe (Option) Allows Enhanced Views ..... 33
- Configuration ..... 38
- Performance Characteristics ..... 40
- Related Literatures ..... 48
- After-purchase License-only Upgrades..... 49
- Return-to-Keysight Service Center Bandwidth Upgrades..... 51
- Download Your Next Insight..... 52

The 3000T X-Series once again redefines what you can expect in a general-purpose oscilloscope by providing all the performance and capability you need to get to measurement insights faster:

## Touch:

8.5-inch capacitive touch screen

Designed for touch interface

## Discover:

Industry's fastest uncompromised waveform update rate

Exclusive zone touch trigger

## Solve:

Wide range of serial decodes

7-in-1 instrument integration

Time/frequency domain correlation



Figure 1. InfiniiVision 3000 X-Series with MegaZoom IV smart memory technology

# Touch: Designed-For-Touch Interface and Capacitive Touch Screen Simplify Use

From the start of product development, we designed every aspect of this oscilloscope to be seamlessly driven by a touch interface. Large, easy-to-touch targets, a graphical user interface that adapts to show you more and be easier to touch, and a large, sensitive, capacitive touch screen all combine to make operation quick and natural, just like your favorite tablet devices.

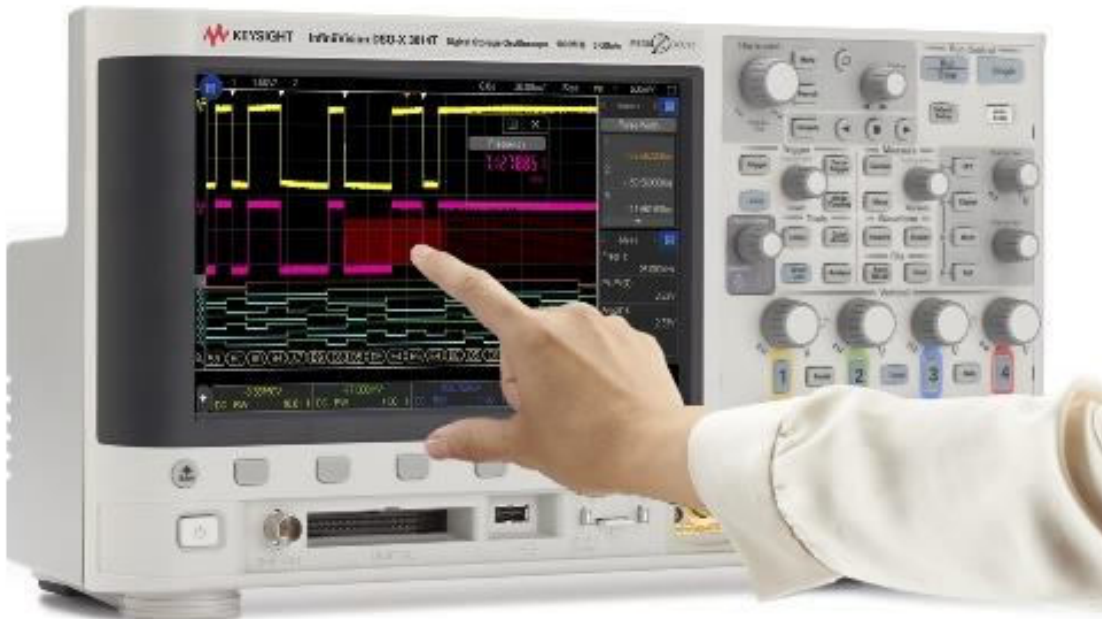

**Figure 2.** The industry's first 8.5" capacitive touch display with large, touchable targets.

## Capacitive touch screen technology enables productivity

The user interface allows you to use the alphanumeric pad for quick annotation, place waveforms or cursors in exact positions and drag docking panels across the screen to see more measurement information.

The 3000T X-Series offers three ways to access key menus and features: touch GUI for those that prefer tablet or smart phone touch interfaces, front panel buttons and knobs for the traditional oscilloscope users, and Keysight Insight pull down menu for users who prefer Windows-like operations. The 3000T X-Series also offers a “touch off” button as well as USB mouse and keyboard support.



**Figure 3.** Side bar with movable docks allows information to be placed on the screen precisely where you want it for documentation.

## Touch interface simplifies documentation

The availability of up to 10 annotations on screen makes it easy to highlight key items on screen shots. Streamline documentation with the ability to input information via a pop-up soft keyboard on the touch screen or a USB keyboard. A sidebar displays additional information without covering the waveform graticule and allows you to dock and scroll through multiple measurement values. Touch gestures (like flicking) make navigating lists or moving between segment waveforms easy.

In addition to the benefits of touch, built-in USB host and USB device ports make PC connectivity easy. The BV0004B oscilloscope control and PC-based software (standard with the purchase of each InfiniiVision X-Series oscilloscope) lets you control and visualize the 3000T X-Series and multiple measurements simultaneously. It lets you build automated test sequences just as easily as you can with the front panel. Save time with the ability to export measurement data to Excel, Word and MATLAB in three clicks. Monitor and control your 3000T X-Series with a mobile device from anywhere. Simplify your testing with BenchVue software.

Learn more at [www.keysight.com/find/BenchVue](http://www.keysight.com/find/BenchVue)



Figure 4. Use BenchVue for remotely logging and plotting measurement data.



**Figure 5.** See up to ten annotations on screen at once for documentation. The standard touch screen makes inputting notes simple.

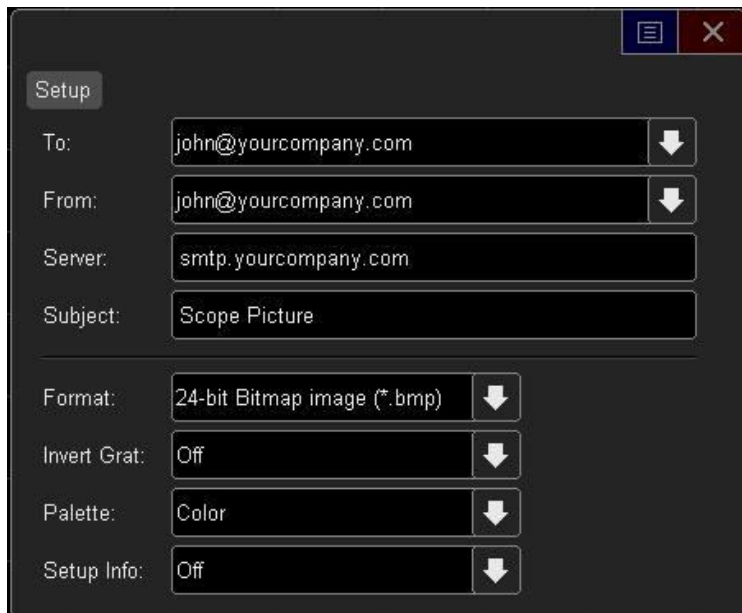

**Figure 6.** With the optional LAN/VGA module you can email yourself setups, data and screenshots.

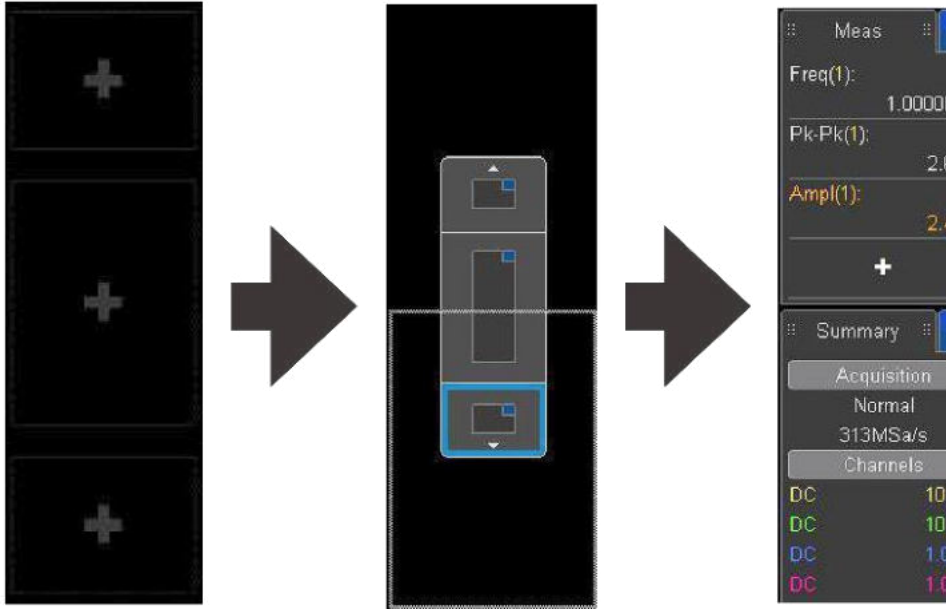

Figure 7. A dockable sidebar allows you to customize how you view your measurements

## Redefine your remote Web control oscilloscope experience

The 3000T X-Series offers traditional control via a PC Web browser, but also supports remote control through popular tablet devices when using the optional LAN/VGA interface.



Figure 8. Remotely control the 3000T X-Series via tablet device.

# Discover: The Industry's Fastest Uncompromised Update Rate Increases the Chance of Finding Anomalies

## Industry-leading uncompromised update rate

If you can't see the problem, you can't fix the problem. With an industry-leading update rate of over one million waveforms per second, the InfiniiVision 3000T X-Series gives you the highest probability of capturing random and infrequent events that you would miss on an oscilloscope with a lower waveform update rate.

Powered by MegaZoom IV smart memory technology, the InfiniiVision 3000T X-Series not only lets you see more waveforms, but it has the uncompromised ability to find the most difficult problems in your design under any conditions. Unlike other oscilloscopes, uncompromised ability means:

- Always-fast, responsive operation
- No slowdown with logic channels on
- No slowdown with protocol decoding on
- No slowdown with math functions on
- No slowdown with measurements on
- No slowdown with vectors on
- No slowdown with sinx/x interpolation on

## What is waveform update rate?

As oscilloscopes acquire data, process it, and plot it to the screen, there is inevitable “dead time,” or the time oscilloscopes miss signals completely. In general, the faster the waveform update rate, the shorter the dead time. The shorter the dead time, the more likely an oscilloscope is to capture anomalies and infrequent events. This is why it is important to select an oscilloscope with a fast waveform update rate. Figures 7 and 8 demonstrate the difference between a slower update rate and a faster update rate.

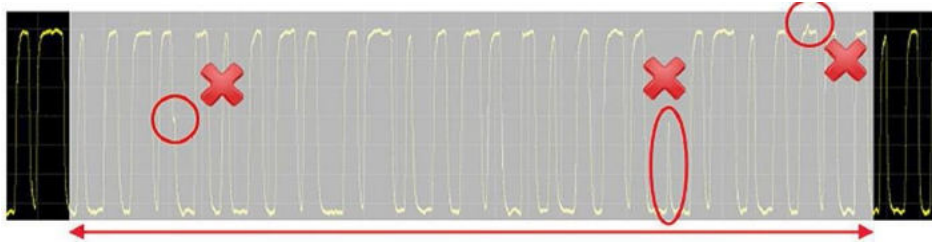

**Figure 9.** Other vendor’s oscilloscope with 50,000 waveforms/second. A long dead time decreases your chances of capturing infrequent events.

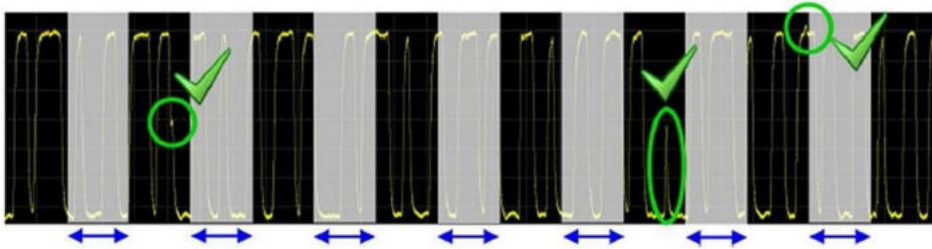

**Figure 10.** InfiniiVision 30000T X-Series with 1,000,000 waveforms/second. A short dead time increases the probability of capturing infrequent events.

But all specs aren’t equal.

Many vendors claim an update rate specification, but that is only in a special mode, or without any features turned on. Table 1 shows the 3000T X-Series’ update rate versus a competing oscilloscope.

While all scopes update rate will vary to some degree by the timebase setting, it is critical that the update rate remain constant regardless of the functionality you are using within the oscilloscope.

**Table 1.** Measured update rate between the 3000T X-Series and the Danaher Tektronix MDO3000. Note how the update rate fluctuates wildly on the MDO3000 based on different settings/features.

10 ns/div

	Keysight 3000T X-Series		Tektronix MDO3000 Series	
	Update rate	Probability	Update rate	Probability
Max with no features on	1,114,000	94%	281,000	50%
Max with digital ch on	1,101,000	94%	132	0.03%
Max with measurements on	1,114,000	94%	2,200	0.55%
Max with FFT on	1,114,000	94%	2,200	0.55%
Max with serial on	1,100,000	94%	1,800	0.45%
Max with ref wfms on	1,113,000	94%	2,200	0.55%

## Why is an uncompromised update rate important?

When debugging or troubleshooting a project, it is important that you see as much signal detail as possible. A fast update rate is just part of the overall equation to determine the likelihood of seeing an anomaly. The frequency of the anomaly, the timebase setting of the oscilloscope and the amount of time you allow the oscilloscope to see the anomaly all come in to play:

$$Pt = 100 \times (1 - [1 - RW]^{(U \times t)})$$

where

Pt = Probability of capturing anomaly in “t” seconds

t = Observation time

U = Scope’s measured waveform update rate

R = Anomalous event occurrence rate

W = Display acquisition window = Timebase setting x 10

Therefore, it is important to select an oscilloscope with the fastest uncompromised update rate to allow enough time to increase your chances of seeing the glitch. In Table 1, in addition to the measured update rate, we show the probability of seeing a glitch that happens 5 times a second while allowing the oscilloscope to acquire for 5 seconds. With the 3000T X-Series you maximize your chances of seeing the infrequent glitch. With the competing scope, if you are using any of the other features like measurements, or search or digital channels, the update rate slows considerably. The only option you have in this case is to allow the oscilloscope to run longer. For example, if you are using digital channels, you’ll have to let the scope run over 8,000 times longer to get a similar probability to the uncompromised update rate of the 3000T X-Series. That’s almost 12 hours of time versus 5 seconds!

## MegaZoom IV smart memory technology enables uncompromised update rate

Traditionally, CPU processing was the major bottleneck for oscilloscope waveform update rate and responsiveness. Typically, the CPU handles interpolations, logic channel plotting, serial bus decoding, measurements and more, and the waveform update rate drops dramatically as these features are turned on.

The InfiniiVision 3000T X-Series requires minimum support from a CPU, as most core operations are handled by Keysight proprietary technology, the MegaZoom IV smart memory ASIC. MegaZoom includes hardware serial decoders and hardware mask limit testing capability, plots analog and digital data directly to the display, supports GUI operation, and integrates additional instruments like the WaveGen function/arbitrary waveform generator.

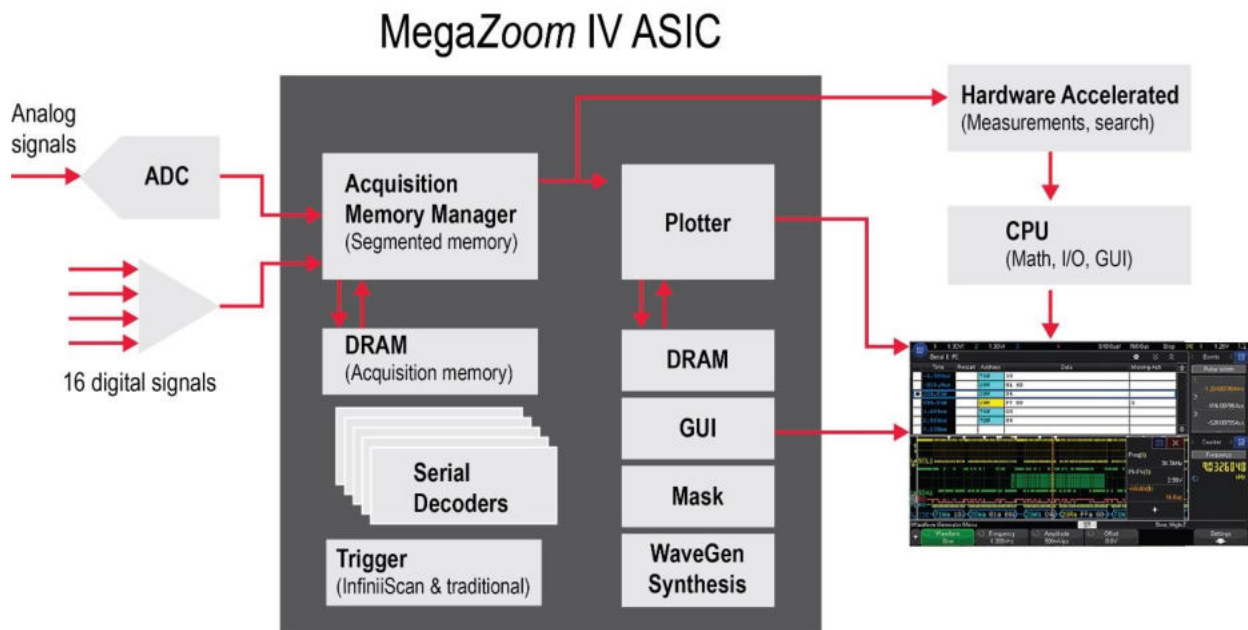

**Figure 11.** The 3000T X-Series oscilloscopes' uncompromised responsiveness, speed and waveform update rate are enabled by the MegaZoom IV, smart memory ASIC. The CPU is not used for core waveform operations.

# Discover: Excellent Signal Integrity Allows you to See More Signal Detail

The 3000T X-Series has excellent signal integrity, including full bandwidth to 1 mV/div and the ability to get up to 12-bits of resolution using the high-resolution acquisition mode.

Some oscilloscopes in this class limit their bandwidth at smaller volt-per-division settings without on-display user notifications. This is likely to keep the noise acceptable at lower volt-per-division settings.

Table 2 shows a comparison of the typical noise floor at 20  $\mu$ s/div between the normal and high-resolution mode. You will notice that the noise floor performance improves as much as five times.

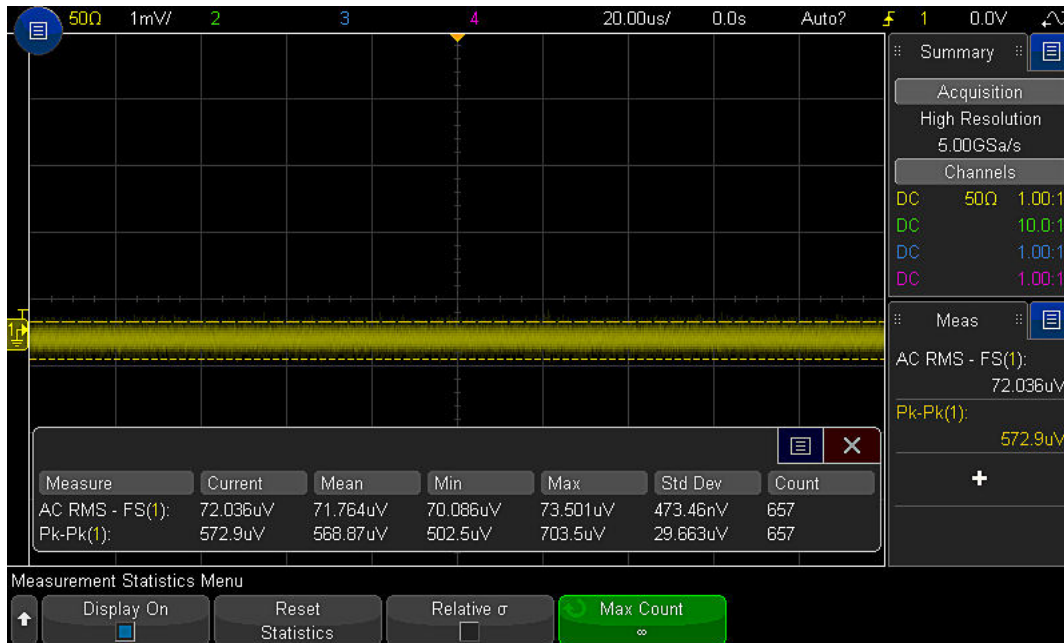

**Figure 12.** High resolution mode allows you to lower your noise and increase your resolution up to 12-bits.

**Table 2.** Noise comparison between the normal and high-resolution mode at 20  $\mu$ s/div.

50  $\Omega$  1 GHz bandwidth Vrms measurement (units = mV)

Vertical setting	Normal mode	High resolution mode	Notes
1 mV	0.277	0.072	Some other manufacturers will limit their bandwidth significantly at these vertical settings, but the Keysight 3000T X-Series provides full bandwidth at all settings.
2 mV	0.277	0.072	
5 mV	0.297	0.081	
10 mV	0.352	0.081	
20 mV	0.597	0.102	
50 mV	1.500	0.340	
100 mV	2.560	0.480	
200 mV	5.500	1.050	
500 mV	15.200	3.630	
1 V	26.000	4.830	

# Discover: Industry Exclusive Zone Touch Trigger Makes Triggering Simple

An uncompromised update rate allows you to see an anomaly, but to continue the debug process you have to isolate it. Setting up a trigger has been a challenge since oscilloscopes introduced a triggered waveform. While oscilloscopes have added more and more triggering capability over the years, setting up triggers has remained complex at best and impossible at worst.

Zone touch trigger eliminates the complexity of setting up advanced triggers. Now, if you can see the event on the display of the oscilloscope, you can trigger on it by just drawing a box on the signal you want to isolate.

See how easy Zone touch triggering can be with these examples.

## Steps to trigger on a runt signal: 3000T X-Series

1. Draw box on the runt
2. Select “must intersect”
3. Draw a second box if needed to further isolate the runt from other runs
4. Select “must intersect” or “must not intersect”

In some cases you may have to select the appropriate source if it wasn't already selected.

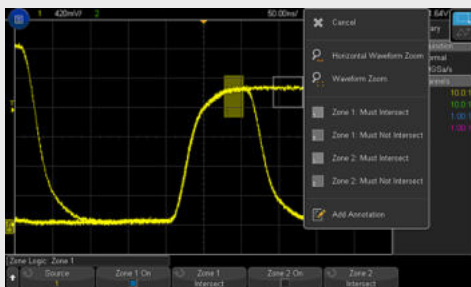

## Traditional Scopes with Advanced Triggers

(assuming the update rate is fast enough to see what you want to trigger on):

1. Select trigger menu
2. Press trigger type
3. Select runt Trigger
4. Select your source
5. Select the runt's polarity
6. Adjust your low threshold to below the runt
7. Adjust your high threshold to above the runt
8. Select when you'll trigger – in this case, we want to trigger on the exact pulse width of the runt
9. Select cursors
10. Move cursor a to the rising edge of the pulse at the 50% mark
11. Move cursor b to the falling edge of the pulse at the 50% mark
12. Obtain the delta time (pulse width) between the cursors
13. Adjust the runt width to be equal to the pulse width that was measured

## Steps to isolate a non-monotonic edge: 3000T X-Series:

Draw box on non-monotonic edge

Select “must intersect”

In some cases you may have to select the appropriate source if it wasn't already selected.

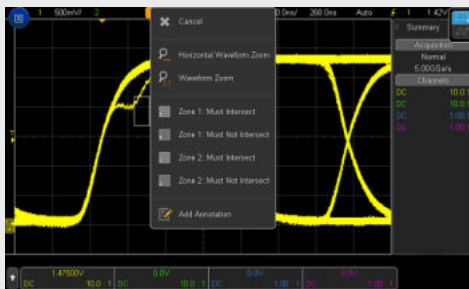

## Traditional Scopes with Advanced Triggers

(assuming the update rate is fast enough to see what you want to trigger on):

Determine what trigger makes the most sense for the signal you are trying to isolate. In this case, we'll try a rise-time trigger first.

1. Select cursors
2. Move cursor a to 10% level
3. Move cursor b to 90% level on the non-monotonic edge
4. Obtain the delta time (rise time) between the cursors
5. Select trigger menu
6. Press trigger type
7. Select Rise/Fall time Trigger
8. Select your source
9. Select your slope
10. Select when you want it to trigger – is it less than, greater than, equal to, not equal to. We'll select greater than.
11. Dial in the “greater than” setting to the measured rise time
12. Adjust your low threshold to the 10% level
13. Adjust your high threshold to the 90% level
14. Adjust your high threshold to the 90% level

# Discover: Standard Segmented Smart Memory Allows you to Capture Longer Periods of Time at High Sample Rates

Acquisition memory size is an essential oscilloscope specification because it determines sustainable sample rate and the amount of time you can capture in a single acquisition. In general, longer memory is better. However, no memory will always be long enough to capture all the signals you need, especially when capturing infrequent anomalies, data bursts, or multiple serial bus packets. Segmented memory acquisition lets you selectively capture and store important signal activity without capturing unimportant signal idle time. In addition, it provides a time stamp of each segment relative to the first trigger event to enable analysis of the frequency of the event. Segmented memory comes standard on the 3000T X-Series.

Figure 13 shows segmented memory successfully capturing 100 small and large glitch events at 5 GSa/s in 47 seconds. Traditional memory architecture would require almost 203G points of memory to accomplish the same result! This memory is not available on any scope in the market.

Furthermore, segmented memory discovered that the worst offender glitch happened 40 seconds from the first trigger event, or at the 95th glitch. It also found out a unique glitch took place 13 seconds after the first glitch. As shown in figure 13a, you can overlay all segments to have a comprehensive view as well.



Figure 13. Segmented memory reveals different types of glitches are taking place.



Figure 13a. Screen showing an overlay of all 100 segments for worst case waveform analysis.

## Discover: Dedicated Search and Navigation Helps you Navigate Deep Memory

Parametric and serial bus search and navigation comes standard on the 3000T X-Series oscilloscopes. When you are capturing long, complex waveforms using an oscilloscope's acquisition memory, manually scrolling through stored waveform data to find specific events of interest can be slow and cumbersome. With automatic search and navigation capability, you can easily set up specific search criteria and then quickly navigate to "found and marked" events. Available search criteria include edges, pulse width (time-qualified), rise/fall times (time-qualified), runt pulses (time-and level-qualified), frequency peaks (FFT function, threshold, and excursion qualified), and serial bus frames, packets, and errors.

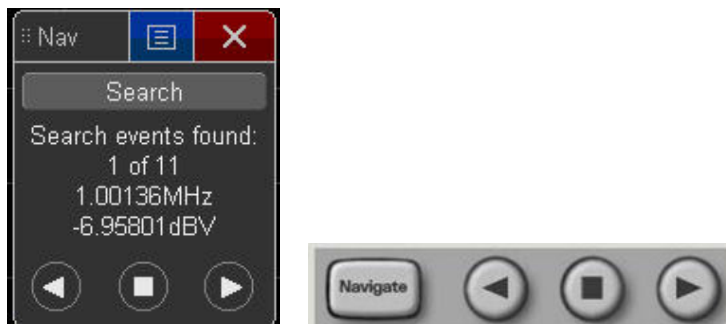

Close-up on buttons on the front panel of the scope. Alternatively, you also can use the touch navigation control.

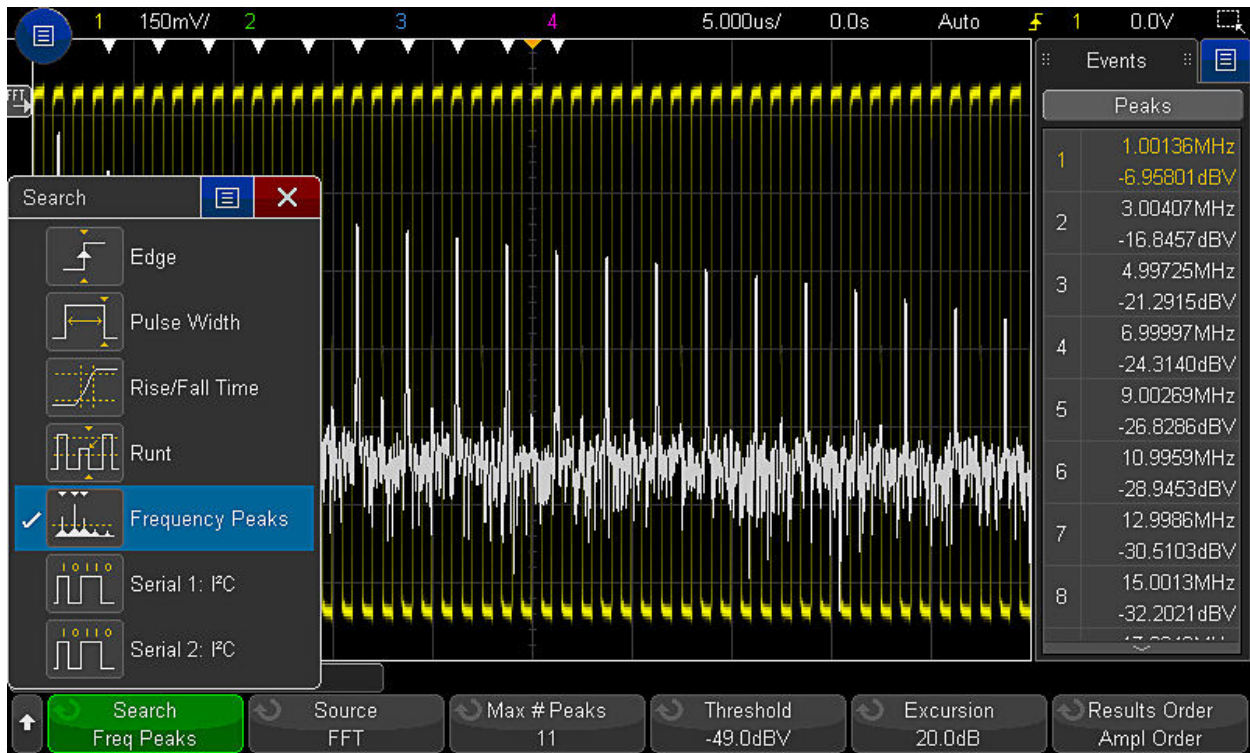

**Figure 14.** The 3000T X-Series was set up to capture clock signals for FFT analysis. Using the search and navigation capability, the scope was able to find, mark (white triangles) and quickly navigate to the first 11 frequency peak occurrences. You can sort it in the order of frequency or amplitude.

## Solve: Integrated Hardware-Based Serial Decoding and Triggering (Option) Makes Easy Work of Low Speed Serial Buses

Keysight InfiniiVision oscilloscopes, including the new 3000T X-Series, use hardware-based serial protocol decoding. Some other vendors use software post-processing techniques to decode serial packets/frames, and therefore have slow waveform and decode capture rates and could miss critical events and errors due to a long dead-time. Faster decoding with hardware-based technology enhances the probability of capturing infrequent serial communication errors.

After capturing serial bus communication, you can easily perform a search operation based on specific criteria and then quickly navigate to bytes/frames of serial data that satisfy that search criteria. The 3000T X-Series can decode two serial buses simultaneously using hardware-based decoding and display the captured data in a time interleaved “lister” display.

Serial protocol decoding can be used simultaneously with segmented memory and Zone touch triggering. The 3000T X-Series has the most decode/trigger capabilities in this class of instrument including I<sup>2</sup>C, SPI, RS232/422/485/UART, CAN, CAN FD, LIN, SENT, CXPI, FlexRay, MIL-STD 1553, ARINC 429, USB PD, and I<sup>2</sup>S.

## Serial decode and trigger options

The 3000T X-Series supports a range of different serial decode and trigger options including:

- I2C
- SPI (2/3/4 wire)
- RS232/422/485/UART
- CAN (symbolic with .dbc file)
- CAN FD (symbolic with .dbc file)
- LIN (symbolic with .ldf file)
- SENT
- CXPI
- FlexRay
- MIL-STD 1553
- ARINC 429
- USB PD
- I2S
- User-definable Manchester
- User-definable NRZ



**Figure 15.** I2C decode and trigger.



**Figure 16.** RS232 decode and trigger.



**Figure 17.** CAN-FD decode and trigger.



**Figure 18.** SPI 4wire decode and trigger.



**Figure 19.** Multi-bus time aligned decode.

# Solve: Segmented Smart Memory Combined with Protocol Analysis Enables Insights Over Long Periods of Time

Segmented memory works in conjunction with any of the optional serial protocol decodes. For example, by setting the trigger condition to “SENT serial bus error,” segmented memory captures and stores only SENT pulse period error packets and stitches together each segment for easy viewing of the decoded data in the lister. You can quickly compare time tags to discover time intervals between errors.

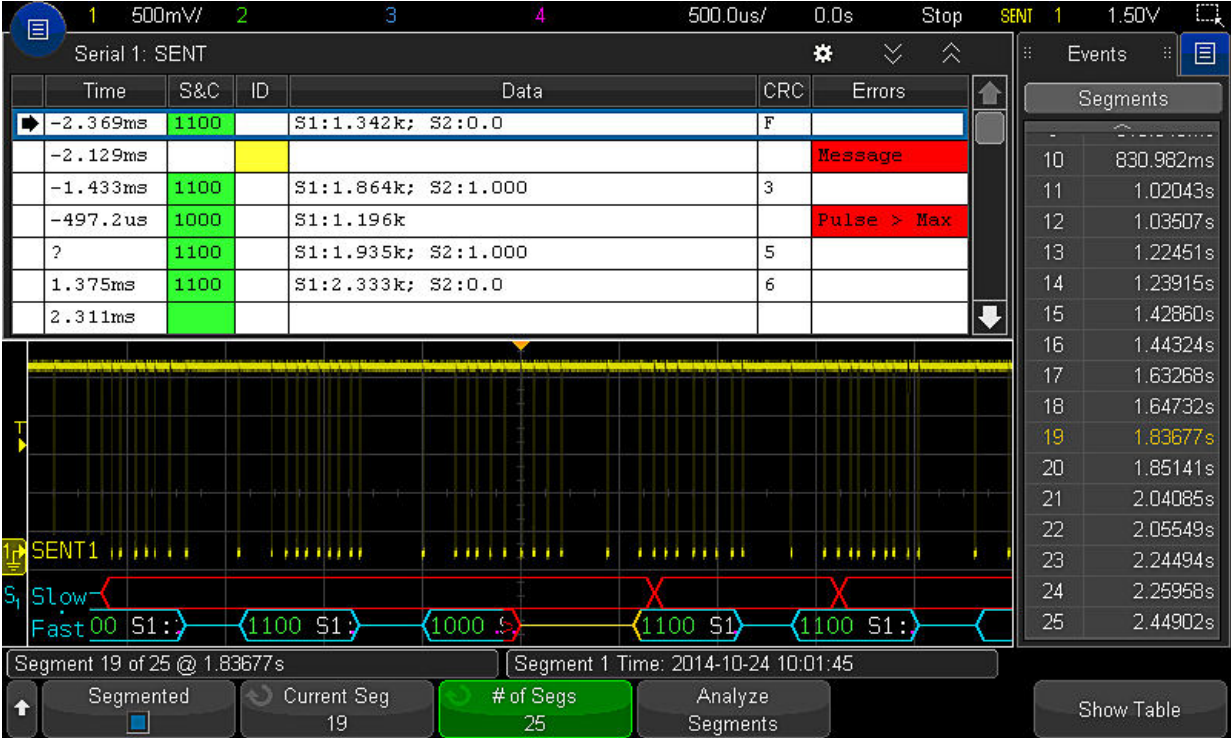

Figure 20. Segmented memory being used in conjunction with SENT bus serial decode resulting in maximum insight to the serial bus.

# Solve: Dedicated Frequency/Spectrum Analysis Allows you to Time-Correlate Analog, Digital, and Frequency Domain Signals in a Single Instrument

Viewing the frequency content of waveforms is greatly simplified by a dedicated FFT button and level adjustment knobs. Pop up keypads make inputting start, stop, span and center frequency easy. And the new problem-solving feature called “gated FFT”, unique in this class of instrument, lets you time correlate the analog, digital, and frequency domain to aid in analysis and debug. In addition, there are new capabilities for peak searching, max and min hold and averaging of FFTs to increase dynamic range.

When gated FFT is on, the oscilloscope goes into zoom mode. The FFT analysis shown in the zoomed (bottom) window is taken from the period of time indicated by the zoom box in the main (top) window. In the gated FFT mode, touch and flick the zoom box through the acquisition to investigate how the FFT analysis changes over time, correlating the RF phenomenon with the analog and digital phenomenon.

Figure 21a through 21d show a simple gated FFT example observing a RF signal frequency transition from 400 MHz to 200 MHz, time correlated to both the SPI controlling signal (digital) and a VCO enable signal (analog). Note, you can also visualize the RF signal itself in the time domain to gain additional insight such as a gap in the RF time domain waveform.



**Figure 21a.** Triggered on a SPI command, the RF signal is still at 400 MHz as indicated in the frequency peak search result lister.



Figure 21b. No RF activities in this zoomed time.



Figure 21c. Start observing the RF signal at 200 MHz. You can validate this from the RF analog waveform as well.



Figure 21d. RF signal settled down at 200 MHz as indicated in the search lister.

# Solve: Standard Advanced Math Capabilities Allow New Views of Signals

Advanced math analysis provides a variety of additional math functions and comes standard on the 3000T X-Series. Additionally, math functions can be nested to provide additional insight into your designs. You can create up to two math functions, with one math function and FFT displayed at a time.

## Advanced math

The 3000T X-Series supports up to two math functions with an assortment of operators, transforms, filters and visualizations:

### Operators

Add, subtract, multiply, divide

### Transforms

- Differentiate, integrate
- FFT (magnitude and phase)
- $Ax + B$
- Squared, square root
- Absolute value
- Common logarithm, natural logarithm
- Exponential, base 10 exponential

### Filters

- Low-pass filter, high-pass filter
- Averaged value
- Smoothing
- Envelope

### Visualizations

- Magnify
- Max and min hold
- Measurement trend
- Chart logic bus timing, chart logic bus state
- Chart serial signal (CAN, CAN FD, LIN, and SENT)
- Maximum and minimum
- Peak-Peak

# Solve: Class Leading Measurements Provide Quick Answers

Automatic measurements are the essential tool of an oscilloscope. In order to make quick and efficient measurements, the 3000T X-Series provides 37 powerful automatic measurements and can display up to 8 at a time. Measurements can be gated by auto select, main window, zoom window, or cursors and include full statistics.

## Measurements

The 3000T X-Series supports 38 automated measurements:

### Voltage

- Peak-to-peak, maximum, minimum, amplitude, top, base, overshoot, pre-shoot, average- N cycles, average- full screen, DC RMS- N cycles, DC RMS- full screen, AC RMS- N cycles, AC RMS- full screen (standard deviation), ratio- N cycles, ratio- full screen

### Time

- Period, frequency, counter, + width, - width, burst width, duty cycle, bit rate, rise time, fall time, delay, phase, X at min Y, X at max Y

### Count

- Positive pulse count, negative pulse count, rising edge count, falling edge count

### Mixed

- Area- N cycles, area- full screen

### Counter

- Built-in frequency counter

# Solve: 7-in-1 Integration Allows New Measurement Possibilities

In addition to the class leading oscilloscope and powerful serial protocol analysis capabilities, the 3000T X-Series offers five additional integrated instrument capabilities not always found in this class of oscilloscope.

## Integrated mixed signal oscilloscope (MSO - optional)

The 3000T X-Series offers 16 optional, integrated and upgradable digital channels. Digital content is everywhere in today's designs and traditional 2 and 4 channel oscilloscopes do not always provide enough channels for the job at hand.

With an additional 16 integrated digital channels, you now have up to 20 channels of time-correlated acquisition and viewing on the same instrument. In addition to offering powerful triggering across the analog and digital channels, this also gives you additional channels to use for serial decode and triggering. And if you buy a 2 or 4 channel DSO, you can upgrade it at any time to an MSO with a software license and 16-channel logic probe.

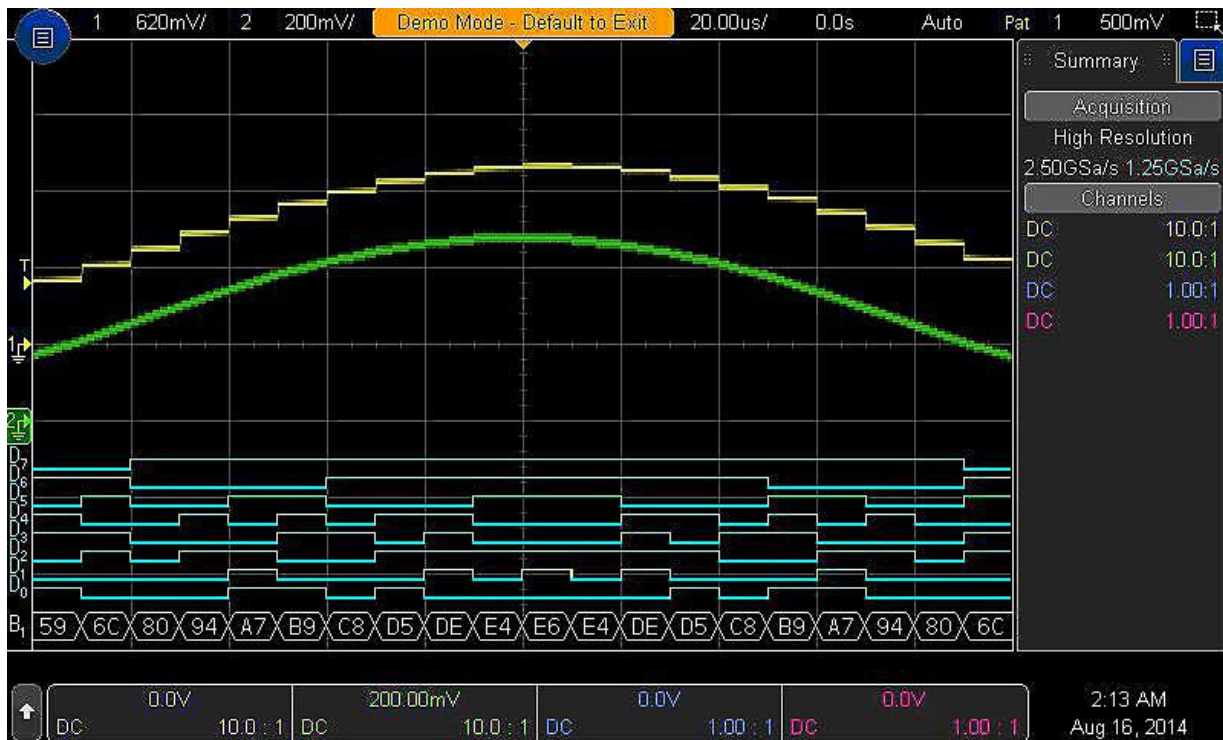

**Figure 22.** Optional digital channels allow a timing view of up to 16 channels. Tightly integrated, they work with the analog triggers and serial triggers/decoding.

## Frequency response analysis (Bode plots, optional)

Frequency Response Analysis (FRA) is an often-critical measurement used to characterize the frequency response (gain and phase versus frequency) of a variety of today's electronic designs, including passive filters, amplifier circuits, and negative feedback networks of switch mode power supplies (loop response). InfiniiVision 3000T X-Series oscilloscopes use the oscilloscope's built-in waveform generator (WaveGen) to stimulate the circuit under test at various frequency settings and capture the input and output signals using two oscilloscope channels. At each test frequency, the oscilloscope measures, computes, and plots gain ( $20\log V_{out}/V_{in}$ ) and phase logarithmically.



Figure 23. Frequency response analysis plot (Bode gain & phase) of a bandpass filter.

## DSOXBODE Bode plot training kit (optional)

The **DSOXBODE** Bode plot training kit consists of a series R-L-C circuit board with a BNC input that attaches directly to the output of the oscilloscope's WaveGen function generator. There are clearly labeled test points for probing VIN and BPFOUT (bandpass filter output) or LPFOUT (low-pass filter output). Also included with this training kit is a comprehensive [tutorial and lab guide](#) that engineering students and professors can download. The DSOXBODE Bode plot training kit is compatible with all InfiniiVision 3000T X-Series oscilloscopes licensed with any software option.



## Integrated WaveGen: Built-in 20 MHz function/arbitrary waveform generator (optional)

The 3000T X-Series offers an integrated 20 MHz function/arbitrary waveform generator, available with modulation support (DSOX3WAVEGEN). The function generator provides stimulus output of sine, square, ramp, pulse, DC, Sinc (x), exponential rise/fall, cardiac, Gaussian Pulse and noise waveforms to your device under test. The modulation feature supports AM, FM, and FSK modulations with modulation shapes of sine, square, and ramp. The generator can output a continuous or a single-shot waveform. With AWG functionality, you can store waveforms from analog channels or reference memory to the arbitrary memory and output from WaveGen. Then easily create or edit the waveform using the built-in editor via touch and the large screen or by using Keysight's BenchLink Waveform Builder software: [www.keysight.com/find/33503](http://www.keysight.com/find/33503)

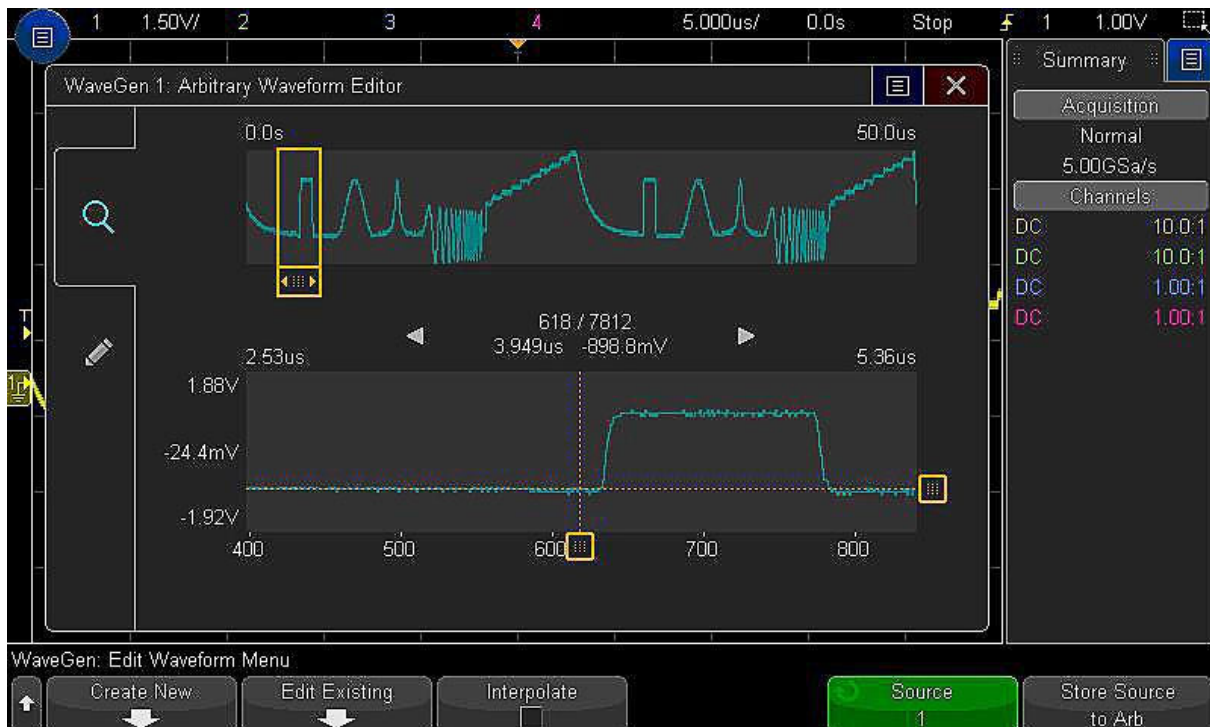

**Figure 24.** Optional arbitrary waveform generator provides easy access to stimulus. The integrated arbitrary waveform generator makes capturing, modifying and replaying signals simple.

## Integrated DVM: Standard 3-digit digital voltmeter

An integrated 3-digit voltmeter is included standard on your 3000T X-Series oscilloscope. The voltmeter operates through the same probes as the oscilloscope channels. However, the DVM measurements are made independently from the oscilloscope acquisition and triggering system so you can make both the DVM and triggered oscilloscope waveform captures with the same connection. The voltmeter results are always displayed, keeping these quick characterization measurements at your fingertips.



**Figure 25.** DVM and counter takes advantage of separate signal paths to provide measurements without a trigger, while still using the scope probes.

## Integrated frequency measurements: Standard 8-digit counter and totalizer

Traditional oscilloscope counter measurements offer only five or six digits of resolution, which may not be enough for the most critical frequency measurements are being made.

With the 3000T X-Series' standard 8-digit counter, you can see your measurements with the precision you would normally expect only from a standalone counter. Because the integrated counter measures frequencies up to a wide bandwidth of 1.0 GHz, you can use it for many high-frequency applications as well.

The counter's totalizer feature adds another valuable capability to the oscilloscope. It can count the number of events (totalize), and it also can monitor the number of trigger-condition-qualified events. The trigger-qualified events totalizer does not require an actual trigger to occur. It only requires a trigger-satisfying event to take place. In other words, the totalizer can monitor events faster than the trigger rate of a scope, as fast as 25 million events per second (a function of the oscilloscope's holdoff time, which has the minimum of 40 ns). Figure 28 shows example of a totalizer counting the number of CAN-FD CRC delimiter bit error packets that took place in a design.

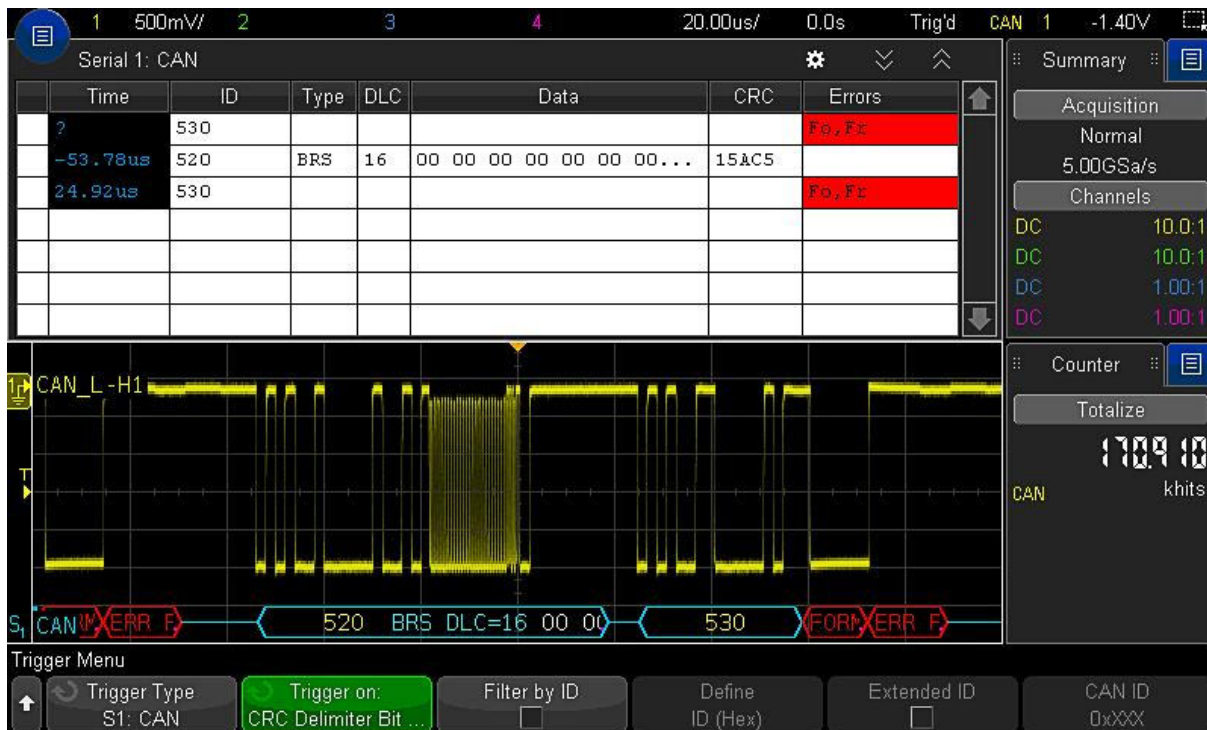
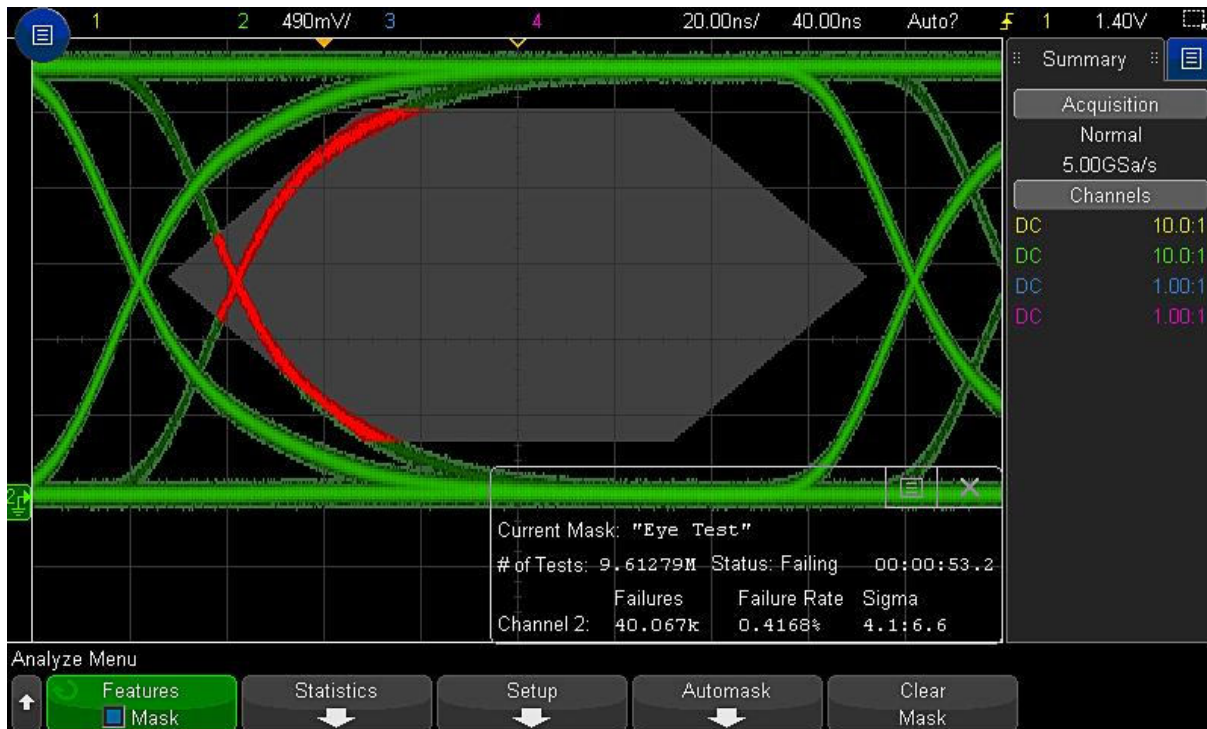

**Figure 26.** Totalizer counts the number of events. In addition, it can count the number of trigger-condition-qualified events as fast as 25 million events a second.

# Solve: Hardware Accelerated Mask Limit Testing and Measurement Limit Testing (Option) Makes It Easy to See the Performance of your Device

Whether you are performing pass/fail tests to specified standards in manufacturing or testing for infrequent signal anomalies, mask limit and measurement limit testing can be a valuable productivity tool. The 3000T X-Series features powerful hardware-based mask testing that can perform up to 270,000 tests per second. You can select multiple test criteria, including the ability to run tests for a specific number of acquisitions, a specified time, or until detection of a failure.

With the optional measurement limit testing capability, you can perform pass/fail testing based on user-defined maximum and minimum limits on any parametric measurement that has been selected and turned on. Stop-on-failure is also available.



**Figure 27.** Hardware accelerated mask testing allows testing against a golden waveform or user created mask to find violations. In this example we captured over 5M tests in only 30 seconds.

# Solve: Integrated Power Measurements and Analysis (Option) Make Short Work of Power Measurements

When you are working with switching power supplies and power devices, the power measurements software package (D3000PWRA) provides a full suite of power measurements and analysis in the oscilloscope.

To learn more about power supply testing, go to [www.keysight.com/find/D3000PWRA](http://www.keysight.com/find/D3000PWRA)

In addition, there are several power specific probes that make analysis of your power supplies

(e.g. switch mode power supplies) and power consuming devices (e.g. batteries) easy.

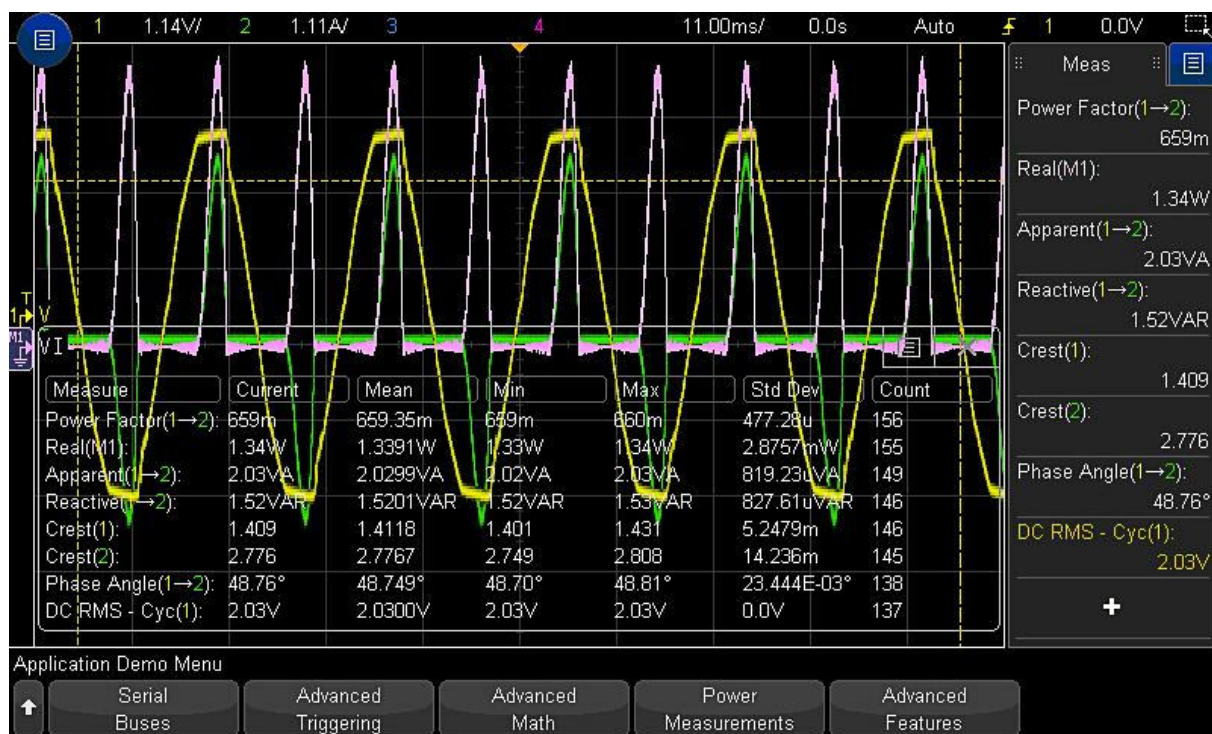

**Figure 28a.** Integrated power measurements make quick work of analyzing power producing and power consuming devices.



Figure 28b. New control loop response analysis (bode plot) shows the gain/phase plot over frequency sweep.

## Solve: Innovative Power Rail Probe (Option) Allows Enhanced Views

The power rail noise, ripple, and transients measurements can be challenging due to required offset range and mV sensitivity. With its  $\pm 24$  V offset range, ultra-low noise 1:1 attenuation ratio, and 2-GHz bandwidth, the N7020A power rail probe is for users making critical power integrity measurements that need mV sensitivity on their DC power rails.



Figure 29a. N7020A Power Rail Probe.

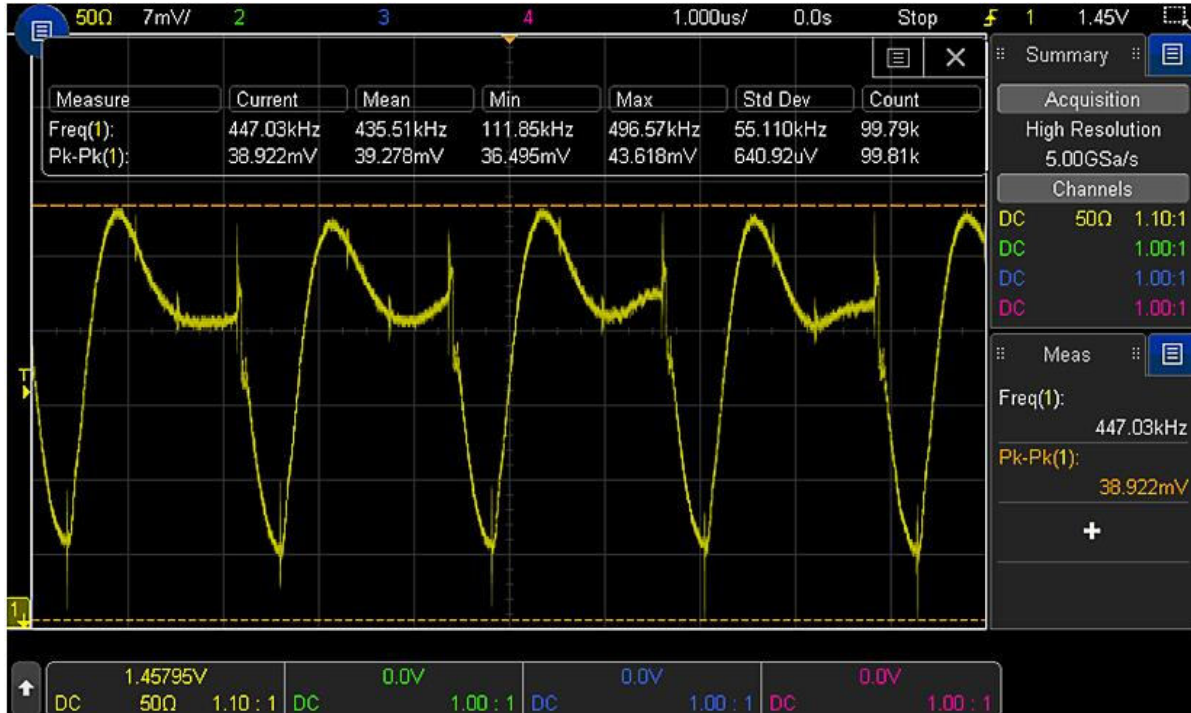

**Figure 29b.** 3000T X-Series and N7020A acquire not only the power rail ripples but the high frequency transients as well.

## Solve: Video Analysis (Option)

Whether you are debugging consumer electronics with HDTV or characterizing a design, Enhanced Video Analysis (optional) provides support for a variety of HDTV standards for triggering and analysis.

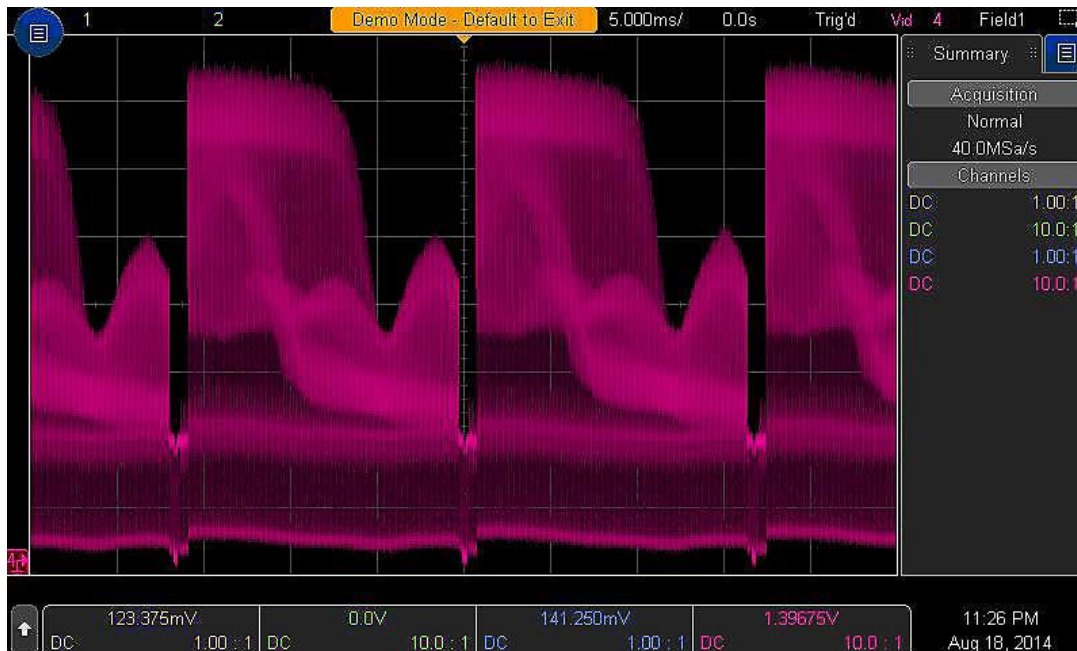

While the “Touch, Discover, Solve” elements of the scope highlight the key features that will make it easy to debug and troubleshoot your device, there are other features that you may also want to consider when choosing your next oscilloscope.

## Total cost of ownership

The 3000T X-Series offers an extremely low cost of ownership. Between an industry leading mean time between failure (MTBF) of over 250,000 hours and a market-leading calibration period of 3 years, you can rest assured that your investment in a 3000T X-Series will be protected for years to come. In addition, because needs change over time, you can purchase just what you need today and then upgrade the scope’s bandwidth or application-specific software packages easily over time as your projects evolve.

## Educator and training kit

Have new hires that need to quickly become familiar with the scope? Or are you a professor that wants to teach your students what an oscilloscope is and how to perform basic measurements? The Educator’s Oscilloscope Training Kit makes that easy. It includes training tools created specifically for electrical engineering and physics undergraduate students and professors. It contains an array of built-in training signals, a comprehensive oscilloscope lab guide and tutorial written specifically for the undergraduate student and an oscilloscope fundamentals PowerPoint slide set for professors and lab assistants. The built-in training signals are included standard on the oscilloscope, while the lab guide and slide set are available to download at [www.keysight.com/find/dsoxedk](http://www.keysight.com/find/dsoxedk).

## Built-in features to help the infrequent user

In addition to the educator’s training kit, the oscilloscope includes a localized front panel and GUI available in 15 languages, along with an integrated (and localized) help system. Just hold any hard key or soft panel button and a brief overview will appear that explains how to use that feature.

## 30-day trial license

The 3000T X-Series comes with a one-time 30-day, all optional-features trial license. You can choose to start the 30-day trial at any time. In addition, you can redeem individual optional feature 30-day trial licenses at any time by visiting [www.keysight.com/find/30daytrial](http://www.keysight.com/find/30daytrial). This enables you to receive in effect 60 days of trial license of each optional feature.

## Localized GUI and front panel options

The 3000T X-Series supports 15 different languages:

- English
- Japanese
- Simplified Chinese
- Traditional Chinese
- Thai
- Korean
- German
- French
- Spanish
- Russian
- Portuguese
- Italian
- Polish
- Czech
- Turkish

“Designed for Touch”.  
**8.5 inch capacitive touch screen with gesture support.**

**7-in-1 instruments** helps you solve your problems: oscilloscope channels digital channels, frequency response analysis, serial protocol analysis, WaveGen, DVM, and 8-digit counter-totalizer. **Fully upgradeable** including bandwidth.

**Reconfigurable Docking panels** with the capacitive touch screen adds a new dimension to the usability.

**Zone touch trigger**, if you can see it, you can trigger on it by drawing a box.

Standard **Gated FFT** for your time correlated analog, digital, and frequency domain signal analysis.

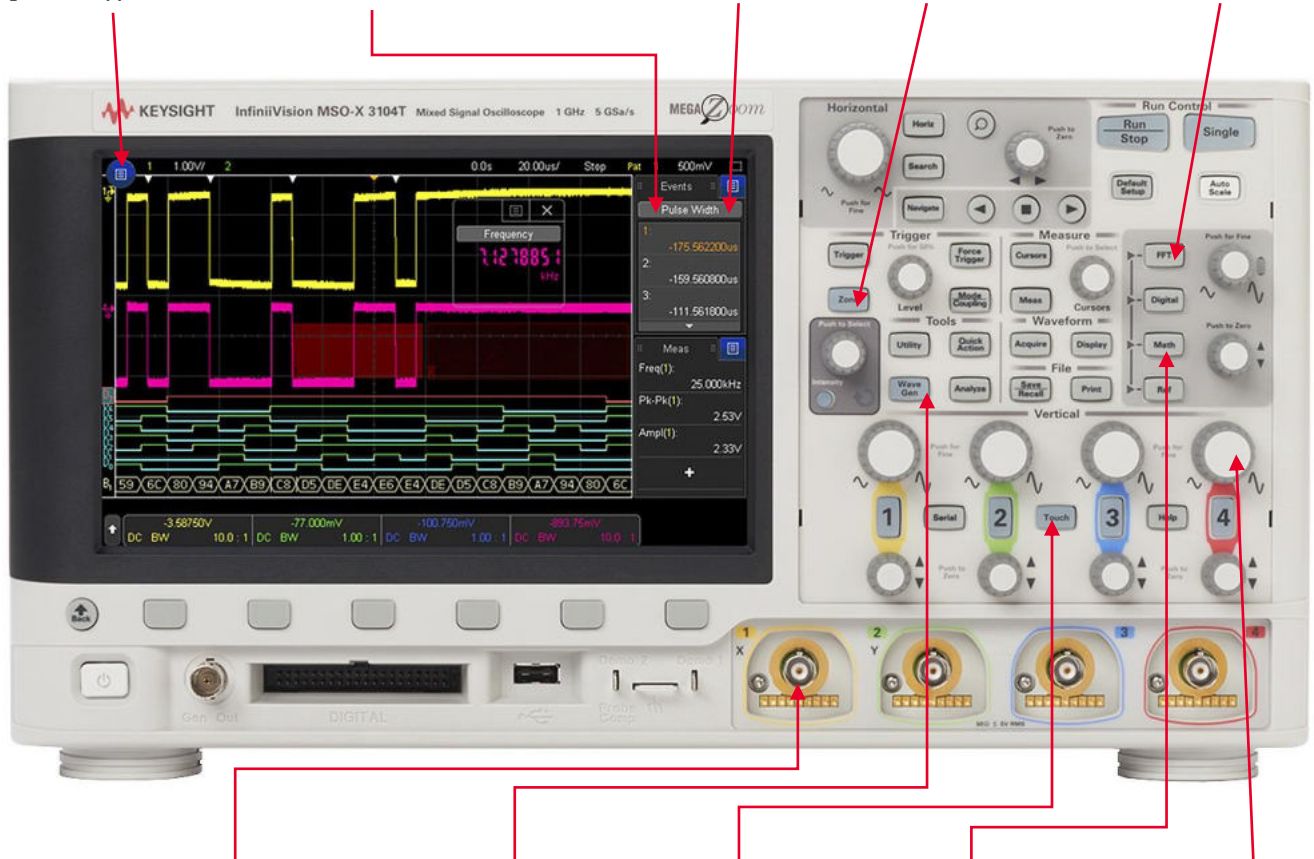

**AutoProbe** interface supports various active, differential, and current probes.

**Build in WaveGen** function/arbitrary generator allows you to capture and regenerate the signals immediately.

Not a touch screen fan? **Turn off the touch screen** from a front panel button.

**Standard advanced math** displays **FFT and one math functions** for your deep analysis.

**Independent knobs per channel** for fast operation. All front panel knobs are **push-able** for access to common controls.

**Uncompromised 1,000,000 waveform per second update rate** minimize the dead-time for maximum probability of capturing infrequent events and anomalies.

Built-in features to help the infrequent user - **GUI available in 15 languages.**

Display up to **8 measurements** simultaneously, without compromising other key info. 38 automatic measurements. **Gated by cursors** supported.

**Integrated DVM** and **8-digit counter with totalizer.** Wide coverage of application and serial protocol solutions including **CAN-FD** and **SENT trigger and decode.**

Both **USB keyboard and mouse** are supported in 3000T X-Series for additional ease of use.

**Standard segment memory with event lister** powered by **MegaZoom IV** smart memory technology intelligent capture of just the signals of interest.

# Configuration

## Step 1. Choose your bandwidth and number of channels

### 3000 X-Series specification overview

		3012T	3014T	3022T	3024T	3032T	3034T	3052T	3054T	3102T	3104T
Bandwidth (-3 dB)		100 MHz		200 MHz		350 MHz		500 MHz		1 GHz	
Calculated rise time (10 to 90%)		≤ 3.5 ns		≤ 1.75 ns		≤ 1 ns		≤ 700 ps		≤ 450 ps	
Input channels	DSOX	2	4	2	4	2	4	2	4	2	4
	MSOX	2 + 16	4 + 16	2 + 16	4 + 16	2 + 16	4 + 16	2 + 16	4 + 16	2 + 16	4 + 16

For example, if you chose 1 GHz, 4+16 channels, the model number will be MSOX3104T

## Step 2. Select hardware upgrades

Hardware upgrade	Description	Model number to order
WaveGen	Built-in 20 MHz function/AWG waveform generator	DSOX3WAVEGEN
Enhanced Security Option	Disable non-volatile memory, USB, LAN, and firmware upgrades	DSOXT3SECA
LAN/VGA module	Plug-in module to support LAN and VGA connectivity	DSOXLAN
GP-IB module	Plug-in module to support GP-IB connectivity	DSOXGPIB

## Step 3. Select software

License upgrade	Description	Model number to order
Embedded software package	I <sup>2</sup> C, SPI, UART (RS232/422/485), I <sup>2</sup> S, and USB PD serial trigger and decode, plus Measurement Limit Testing, Mask Limit Testing, Frequency Response Analysis (Bode plots), and Enhanced Video Analysis	D3000GENB
Automotive software package	CAN (symbolic with .dbc file), CAN FD (symbolic with .dbc file), LIN (symbolic with .ldf file), FlexRay, SENT, CXPI, PSI5 (user-definable Manchester), and User-definable NRZ serial trigger & decode, plus Measurement Limit Testing, Mask Limit Testing (CAN/CAN FD mask files available to download) and Frequency Response Analysis (Bode plots)	D3000AUTB
Aero software package	MIL-STD 1553 and ARINC 429 serial trigger & decode, plus Measurement Limit Testing, Mask Limit Testing (standard mask files available to download), Frequency Response Analysis (Bode plots), and Enhanced Video Analysis	D3000AERB
Power software package	Power quality, current harmonics, switching loss, transient response, turn-on/off time, output ripple, efficiency, loop response, PSRR, etc., plus Measurement Limit Testing, Mask Limit Testing and Frequency Response Analysis (Bode plots), and USB PD serial trigger & decode	D3000PWRB
NFC software package	NFC trigger and PC-based automated test software	D3000NFCB
Ultimate bundle software package	I <sup>2</sup> C, SPI, UART, I <sup>2</sup> S, CAN, CAN FD, LIN, FlexRay, CXPI, PSI5 (User-definable Manchester), User-definable NRZ, USB PD, MIL-STD 1553, and ARINC 429 serial trigger & decode, plus Power Analysis, Measurement Limit Testing, Mask Limit Testing, Frequency Response Analysis (Bode plots), Enhanced Video Analysis, NFC trigger & automated test software	D3000BDLB

## Step 4. Choose your probes

For a complete list of compatible probes, visit [www.keysight.com/find/scope\\_probes](http://www.keysight.com/find/scope_probes). In general, the 3000T X-Series supports up to two active probes simultaneously with some exceptions.

Contact Keysight for more detail.

### Probes

N2843A	Passive probe 500 MHz, 10:1, 1 M $\Omega$ , 11 pF	Standard (1 per channel)
N2756A	16 digital channel MSO cable	Standard on MSOX models & DSOXT3MSO
N2870A	Passive probe 35 MHz, 1:1, 1 M $\Omega$	Optional
10076C	Passive probe 500 MHz 100:1 attenuation (4 kV)	Optional
N2804A	300 MHz 100:1 differential probe, 4 M $\Omega$ , 4 pF, $\pm$ 300 V DC+peak AC	Optional
N2805A	200 MHz 100:1 differential probe, 4 M $\Omega$ , 4 pF, $\pm$ 100 V, 5 m cable	Optional
N2790A	100 MHz 50:1/500:1 high voltage differential probe, 8 M $\Omega$ , 3.5 pF, $\pm$ 1,400 V	Optional
N2795A	Active single-ended probe 1 GHz 1 pF 1 M $\Omega$ with AutoProbe	Optional
N2797A	Active single-ended probe 1.5 GHz extreme temperature	Optional
N2750A	InfiniiMode differential probe 1.5 GHz 700 fF 200 k $\Omega$ with AutoProbe	Optional
N2790A	Differential active probe 100 MHz, $\pm$ 1.4 kV with auto probe	Optional
N2791A	Differential active probe 25 MHz, $\pm$ 700 V	Optional
N2818A	200 MHz 10:1 differential probe with AutoProbe	Optional
N2819A	800 MHz 10:1 differential probe with AutoProbe	Optional
1147B	AC/DC current probe 50 MHz 15 A with auto probe	Optional
N2893A	AC/DC current probe 100 MHz 15 A with auto probe	Optional
N2820A	2-channel high-sensitivity current probe 50 $\mu$ A to 5 A	Optional
N2821A	1-channel high-sensitivity current probe 50 $\mu$ A to 5 A	Optional
N7020A	Power rail probe 2 GHz, 1:1, $\pm$ 24 V offset range at 50 $\Omega$	Optional
N7040A	23 MHz, 3 kA, AC current probe	Optional
N7041A	30 MHz, 600 A, AC current probe	Optional
N7042A	30 MHz, 300 A, AC current probe	Optional
N7026A	AC/DC high-sensitivity current probe 150 MHz, 40 Apk with AutoProbe interface	Optional

## Step 5. Choose your accessories and additional productivity software

### Recommended accessories and PC software

DSOXBODE	Bode plot training kit	Optional
N2747A	Front panel cover	Optional
N6456A	Rack mount kit	Optional
N6457A	Soft carrying case with front panel cover	Optional
Hard transit case	CaseCruzer 3F1112-1510J (available from <a href="http://www.casecruzer.com/">http://www.casecruzer.com/</a> )	Optional
BV0004B	BenchVue Oscilloscope Application PC software	Standard
33503A	BenchLink Waveform Builder Pro and Basic PC Software	Optional
D9010BSEO	Infiniium Offline Oscilloscope Analysis PC Software	Optional
D9010UDAA	User-definable Application (UDA) software	Optional
89601B (version 2020 and higher)	Vector Signal Analyzer (VSA) software	Optional

## Step 6. Calibration plans

### Calibration and warranties

D/MSOX3000T-A6J	ANSI Z540-1-1994 calibration	Optional
D/MSOX3000T-AMG	ISO17025 compliant calibration with accreditation	Optional

# Performance Characteristics

## DSO and MSO 3000 X-Series oscilloscope

### 3000T X-Series specification overview

		3012T	3014T	3022T	3024T	3032T	3034T	3052T	3054T	3102T	3104T
Bandwidth 1 (-3 dB)		100 MHz		200 MHz		350 MHz		500 MHz		1 GHz	
Calculated rise time (10 to 90%)		≤ 3.5 ns		≤ 1.75 ns		≤ 1 ns		≤ 700 ps		≤ 450 ps	
Input channels	DSOX	2	4	2	4	2	4	2	4	2	4
	MSOX	2 + 16	4 + 16	2 + 16	4 + 16	2 + 16	4 + 16	2 + 16	4 + 16	2 + 16	4 + 16
Maximum sample rate		5 GSa/s half channels, 2.5 GSa/s all channels									
Maximum memory depth		4 Mpts half channels, 2 Mpts all channels									
Display size and type		8.5-inch capacitive touch gesture-enabled display									
Waveform update rate		> 1,000,000 waveforms per second									
<b>Vertical system analog channels</b>											
Hardware bandwidth limits		Approximately 20 MHz (selectable)									
Input coupling		AC, DC									
Input impedance		Selectable: 1 MΩ ± 1% (14 pF), 50 Ω ± 1.5%									
Input sensitivity range		100 MHz ~ 500 MHz models: 1 mV/div to 5 V/div 2 (1 MΩ and 50 Ω) 1 GHz models: 1 mV/div to 5 V/div 2 (1 MΩ), 1 mV/div to 1 V/div (50 Ω)									
Vertical resolution		8 bits (measurement resolution is 12 bits with averaging)									
Maximum input voltage		135 Vrms; 190 Vpk Probing technology allows testing of higher voltages. For example, the included N2843A 10:1 probe supports testing up to 300 Vrms Use this instrument only for measurements within its specified measurement category (not rated for CAT II, III, IV). No transient overvoltage allowed									
DC vertical accuracy		± [DC vertical gain accuracy + DC vertical offset accuracy + 0.25% full scale] <sup>2</sup>									
DC vertical gain accuracy <sup>1</sup>		± 2.0% full scale <sup>2</sup>									
DC vertical offset accuracy		± 0.1 div ± 2 mV ± 1% of offset setting									
Channel-to-channel isolation		> 100:1 from DC to maximum specified bandwidth of each model (measured with same V/div and coupling on channels)									
Offset range		± 2 V (1 mV/div to 200 mV/div) ± 50 V (> 200 mV/div to 5 V/div)									
<b>Vertical system digital channels</b>											
Digital input channels		16 digital (D0 to D15. pod 1: D7 ~ D0, Pod 2: D15 ~ D8)									
Thresholds		Threshold per pod									
Threshold selections		TTL (+1.4 V), 5 V CMOS (+2.5 V), ECL (-1.3 V), user-defined (selectable by pod)									
User-defined threshold range		± 8.0 V in 10 mV steps									
Maximum input voltage		± 40 V peak CAT I									
Threshold accuracy <sup>1</sup>		± (100 mV + 3% of threshold setting)									
Maximum input dynamic range		± 10 V about threshold									
Minimum voltage swing		500 mVpp									
Input impedance		100 kΩ ± 2% at probe tip									
Input capacitance		~8 pF									
Vertical resolution		1 bit									

1. Denotes warranted specifications, all others are typical.

2. Specifications are valid after a 30-minute warm-up period and ± 10 °C from firmware calibration temperature. 1 mV/div and 2 mV/div are a magnification of 4 mV/div setting. For vertical accuracy calculations, use full scale of 32 mV for 1 mV div and 2 mV/div sensitivity setting.

### Horizontal system analog channels

	3012T	3014T	3022T	3024T	3032T	3034T	3052T	3054T	3102T	3104T
Time base range	5 ns/div to 50 s/div		2 ns/div to 50 s/div				1 ns/div to 50 s/div		500 ps/div to 50 s/div	
Time base accuracy <sup>1</sup>	± 1.6 ppm + aging factor (1st year: ± 0.5 ppm, 2nd year: ± 0.7 ppm, 5 years: ± 1.5 ppm, 10 years: ± 2.0 ppm)									
Time base delay time range	Pre-trigger	Greater of 1 screen width or 250 µs								
	Post-trigger	1 s to 500 s								
Channel-to-channel deskew range	± 100 ns									
Δ Time accuracy (using cursors)	± (time base acc. x reading) ± (0.0016 x screen width) ± 100 ps									
Modes	Main, zoom, roll, XY									
XY	On channels 1 and 2 only. Z Blanking on Ext Trigger Input, 1.4 V threshold									
	Bandwidth: Maximum bandwidth. Phase error at 1 MHz: < 0.5 degree									

### Horizontal system digital channels

Minimum detectable pulse width	5 ns									
Channel-to-channel skew	2 ns (typical); 3 ns (maximum)									

### Acquisition system

Maximum analog channels sample rate	5 GSa/s half channel interleaved, 2.5 GSa/s all channel									
Maximum analog channels record length	4 Mpts half channel interleaved, 2 Mpts all channel									
Maximum digital channels sample rate	1.25 GSa/s all pods									
Maximum digital channels record length	2 Mpts (with digital channels only)									
Acquisition mode	Normal	Default mode								
	Peak detect	Capture glitches as narrow as 250 ps at all time base settings								
	Averaging	Selectable from 2, 4, 8, 16, 64, ... to 65,536								
	High resolution	Real time boxcar averaging reduces random noise and effectively increases vertical resolution 12 bits of resolution when ≥ 10 µs/div at 5 GSa/s or ≥ 20-µs/div at 2.5 GSa/s								
	Segmented	Segmented memory optimizes available memory for data streams that have long dead times between activity. Maximum segments = 1000. Re-arm time = 1 µs (minimum time between trigger events)								
Time mode	Digitizer	Allows independent selection of sample rate and memory depth								
	Normal	Default mode								
	Roll	Displays the waveform moving across the screen from right to left. Available at the time base 50 ms/div or slower								
	XY	Displays the volts-versus-volts display. Time base can be set from 200 ns/div to 50 ms/div								

1. Denotes warranted specifications, all others are typical. Specifications are valid after a 30-minute warm-up period and ± 10 °C from firmware calibration temperature.

Trigger system	
Trigger sources	Analog channel (1 ~ 4), digital channel (D0 ~ D15), line, external, WaveGen (1 or mod) (FM/FSK)
Trigger modes	Normal (triggered): Requires trigger event for scope to trigger
	Auto: Triggers automatically in absence of trigger event
	Single: Triggers only once on a trigger event, press [Single] again for scope to find another trigger event, or press [Run] to trigger continuously in either Auto or Normal mode
	Force: front panel button that forces a trigger
Trigger coupling	DC: DC coupled trigger
	AC: AC coupled trigger, cutoff frequency: < 10 Hz (internal); <50 Hz (external)
	HF reject: High frequency reject, cutoff frequency ~ 50 kHz
	LF reject: Low frequency reject, cutoff frequency ~ 50 kHz
Noise reject: Selectable OFF or ON, decreases sensitivity 2x	
Trigger holdoff range	40 ns to 10.00 s
Trigger sensitivity	
Internal <sup>1</sup>	< 10 mV/div: Greater of 1 div or 5 mV; ≥ 10 mV/div: 0.6 div
External <sup>1</sup>	200 mVpp from DC to 100 MHz
	350 mVpp 100 MHz to 200 MHz
Trigger level range	
Any channel	± 6 div from center screen
External	± 8 V
Trigger type selections	
Zone (HW zone qualifier)	Trigger on user-defined zones drawn on the display. Applies to one analog channel at a time. Specify zones as either "must intersect" or "must not intersect." Up to two zones. > 200,000 scans/sec update rate
	Supported modes: normal, peak detect, high resolution
	Also works simultaneously with the serial trigger and mask limit test
Edge	Trigger on a rising, falling, alternating or either edge of any source
Edge then edge (B trigger)	Arm on a selected edge, wait a specified time, then trigger on a specified count of another selected edge
Pulse width	Trigger on a pulse on a selected channel, whose time duration is less than a value, greater than a value, or inside a time range
	Minimum duration setting: 2 ns (500 MHz, 1 GHz), 4 ns (350 MHz), 6 ns (200 MHz), 10 ns (100 MHz)
	Maximum duration setting: 10 s
	Range minimum: 10 ns
Runt	Trigger on a position runt pulse that fails to exceed a high-level threshold. Trigger on a negative runt pulse that fails to exceed a low-level threshold. Trigger on either polarity runt pulse based on two threshold settings. Runt triggering can also be time-qualified (< or >) with a minimum time setting of 2 ~ 10 ns and maximum time setting of 10 s
	Minimum time setting: 2 ns (500 MHz, 1 GHz), 4 ns (350 MHz), 6 ns (200 MHz)
	10 ns (100 MHz)
Setup and hold	Trigger and clock/data setup and/or hold time violation. Setup time can be set from -7 to 10 s. Hold time can be set from 0 s to 10 ns
Rise/fall time	Trigger on rise-time or fall-time edge speed violations (< or >) based on user-selectable threshold
	Select from (< or >) and time settings range between
	Minimum: 1 ns (500 MHz, 1 GHz), 2 ns (350 MHz), 3 ns (200 MHz), 5 ns (100 MHz)
	Maximum: 10 s

1. Denotes warranted specifications, all others are typical. Specifications are valid after a 30-minute warm-up period and ± 10 °C from firmware calibration temperature.

## Trigger type selections

N <sup>th</sup> edge burst	Trigger on the Nth (1 to 65535) edge of a pulse burst. Specify idle time (10 ns to 10 s) for framing
Pattern	Trigger when a specified pattern of high, low, and don't care levels on any combination of analog, digital, or trigger channels is [entered   exited]. Pattern must have stabilized for a minimum of 2 ns to qualify as a valid trigger condition
	Minimum duration setting: 2 ns (500 MHz, 1 GHz), 4 ns (350 MHz), 6 ns (200 MHz), 10 ns (100 MHz)
	Maximum duration setting: 10 s Range minimum: 10 ns
Or	Trigger on any selected edge across multiple analog or digital channels
Video	Trigger on all lines or individual lines, odd/even or all fields from composite video, or broadcast standards (NTSC, PAL, SECAM, PAM-M)
Enhanced Video (optional)	Trigger on lines and fields of enhanced and HDTV standards (480p/60, 567p/50, 720p/50, 720p/60, 1080p/24, 1080p/25, 1080p/30, 1080p/50, 1080p/60, 1080i/50, 1080i/60)
USB	Trigger on start of packet, end of packet, reset complete, enter suspend, or exit suspend. Support USB low-speed and full-speed
I2C (optional)	Trigger at a start/stop condition or user defined frame with address and/or data values. Also trigger on missing acknowledge, address with no ack, restart, EEPROM read, and 10-bit write
SPI (optional)	Trigger on SPI (Serial Peripheral Interface) data pattern during a specific framing period. Supports positive and negative Chip Select framing as well as clock Idle framing and user-specified number of bits per frame. Supports MOSI and MISO data
RS-232/422/485/UART (optional)	Trigger on Rx or Tx start bit, stop bit or data content or parity error
I <sup>2</sup> S (optional)	Trigger on 2's complement data of audio left channel or right channel (=, ≠, <, >, > <, <>, increasing value, or decreasing value)
CAN (optional)	Trigger on CAN (controller area network) version 2.0A, 2.0B, and CAN-FD (Flexible Data-rate) signals. Trigger on the start of frame (SOF), the end of frame (EOF), data frame ID, data frame ID and data (non-FD), data frame ID and data (FD), remote frame ID, remote or data frame ID, error frame, acknowledge error, from error, stuff error, CRC error, spec error (ack or form or stuff or CRC), all errors, BRS Bit (FD), CRC delimiter bit (FD), ESI bit active (FD), ESI bit passive (FD), overload frame., message, message and signal (non-FD), message and signal (FD, first 8 bytes only)
LIN (optional)	Trigger on LIN (Local Interconnect Network) sync break, sync frame ID, or frame ID and data, parity error, checksum error, frame (symbolic), frame and signal (symbolic)
CXPI (optional)	Trigger on the start of frame (SOF), the end of frame (EOF), PTYPE, frame ID, data and info frame ID, data and info frame ID (long frame), CRC field error, parity error, inter-byte space error, inter-frame space error, framing error, data length error, sample error, all errors, sleep frame, wakeup pulse
FlexRay (optional)	Trigger on frame ID, frame type (sync, start-up, null, normal), cycle-repetitive, cycle-base, and errors.
MIL-STD 1553 (optional)	Trigger on MIL-STD 1553 signals based on word type (Data or Command/Status), Remote Terminal Address, data, and errors (parity, sync, Manchester encoding)
ARINC 429 (optional)	Trigger on ARINC429 data. Trigger on word start/stop, label, label + bits, label range, error conditions (parity, word, gap, word or gap, all), all bits (eye), all 0 bits, all 1 bits
SENT (optional)	Trigger on SENT bus. start of fast channel message, start of slow channel message, fast channel SC and data, slow channel message ID, slow channel message ID and data, tolerance violation, fast channel CRC error, slow channel CRC error, all CRC errors, pulse period error, successive sync pulses error (1/64)
User-definable Manchester/NRZ (optional)	Trigger on start-of-frame (SOF), bus value, and Manchester errors
USB PD (optional)	Trigger on preamble, EDP, ordered sets, preamble errors, CRC errors, header content (control messages, data messages, extended messages and value in HEX)
NFC (optional)	Trigger on NFC-A, NFC-B, NFC-F (212 kbps), and NFC-F (424 kbps)

Waveform measurements		
Cursors <sup>2</sup>		Single cursor accuracy: $\pm$ [DC vertical gain accuracy + DC vertical offset accuracy + 0.25% full scale]
		Dual cursor accuracy: $\pm$ [DC vertical gain accuracy + 0.5% full scale] <sup>1</sup>
		Units: Seconds(s), Hz (1/s), phase (degrees), ratio (%)
Automatic measurements		Measurements continuously updated with statistics. Cursors track last selected measurement. Select up to eight measurements from the list below: Snapshot All: Measure all single waveform measurements (31) Vertical: Peak-to-peak, maximum, minimum, amplitude, top, base, overshoot, pre-shoot, average- N cycles, average- full screen, DC RMS- N cycles, DC RMS- full screen, AC RMS- N cycles, AC RMS- full screen (std deviation), ratio- N cycle, ratio- full screen, "Y at X" Time: Period, frequency, counter, + width, - width, burst width, +duty cycle, -duty cycle, bit rate, rise time, fall time, delay, phase, X at min Y, X at max Y, "time at edge" Count: Positive pulse count, negative pulse count, rising edge count, falling edge count Mixed: Area- N cycles, area- full screen, "slew rate"
Automatic measurement logging		Available via BenchVue
Counter		Built-in frequency counter
		Source: On any analog or digital channel
		Resolution: 5 digits
		Maximum frequency: Bandwidth of scope
Waveform math		
Number of math functions		Two, displays FFT and one math simultaneously. Can be cascaded
Arithmetic		Add, subtract, multiply, divide, differentiate, integrate, FFT, Ax + B, squared, square root, absolute value, common logarithm, natural logarithm, exponential, base 10 exponential, low pass filter, high pass filter, averaged value, smoothing, envelope, magnify, max hold, min hold, measurement trend, chart logic bus (Timing or State), chart serial signal (CAN, CAN FD, LIN, and SENT)
Enhanced FFT	Record size	Up to 64 kpts resolution
	Window types	Hanning, Flat Top, Rectangular, Blackman-Harris, Bartlett
	Time gated FFT	Gate the time range of data for FFT analysis in the zoom view. For time and frequency domain correlated analysis.
	Waveforms	FFT, max hold, min hold, average
	Peak search	Max 11 peaks, threshold and excursion control
Search, navigate, and lister		
Type		Edge, pulse width, rise/fall, runt, frequency peak, serial bus 1, serial bus 2
Copy		Copy to trigger, copy from trigger
Frequency peak	Source	Math functions
	Max # of peaks	11
	Control	Results order in frequency or amplitude
Result display		Event lister or navigation. Manual or auto scroll via navigation or touch event lister entry to jump to a specific event
Display Characteristics		
Display		8.5-inch capacitive touch/gesture enabled TFT LCD
Resolution		800 (H) x 480 (V) pixel format (screen area)
Graticules		8 vertical divisions by 10 horizontal divisions with intensity controls
Format		YT, XY, and Roll
Maximum waveform update rate		> 1,000,000 waveforms/sec
Persistence		Off, infinite, variable persistence (100 ms to 60 s)
Intensity gradation		64 intensity levels

1. Denotes warranted specifications, all others are typical.  
Specifications are valid after a 30-minute warm-up period and  $\pm 10$  °C from firmware calibration temperature.
2. 1 mV/div and 2 mV/div is a magnification of 4 mV/div setting. For vertical accuracy calculations, use full scale of 32 mV for 1 mV/div and 2 mV/div sensitivity setting.

**WaveGen – Built-in Function/Arbitrary Waveform Generator (specifications are typical)**

WaveGen out	Front-panel BNC connector
Waveforms	Sine, Square, Ramp, Pulse, DC, Noise, Sine Cardinal (Sinc), Exponential Rise, Exponential Fall, Cardiac, Gaussian Pulse, and Arbitrary
Modulation	Modulation types: AM, FM, FSK Carrier waveforms: sine, ramp, sine cardinal, exponential rise, exponential fall, and cardiac Modulation source: internal (no external modulation capability)
	AM: Modulation: sine, square, ramp Modulation frequency: 1 Hz to 20 kHz Depth: 0% to 100%
	FM: Modulation: sine, square, ramp Modulation frequency: 1 Hz to 20 kHz Minimum carrier frequency: 10 Hz Deviation: 1 Hz to carrier frequency or $(2e12 / \text{carrier frequency})$ , whichever is smaller
FSK: Modulation: 50% duty cycle square wave FSK rate: 1 Hz to 20 kHz Hop frequency: 2 x FSK rate to 10 MHz	
Sine	Frequency range: 0.1 Hz to 20 MHz Amplitude flatness: $\pm 0.5$ dB (relative to 1 kHz) Harmonic distortion: $-40$ dBc Spurious (non harmonics): $-40$ dBc Total harmonic distortion: 1% SNR (50 $\Omega$ load, 500 MHz BW): 40 dB ( $V_{pp} \geq 0.1$ V); 30 dB ( $V_{pp} < 0.1$ V)
Square wave /pulse	Frequency range: 0.1 Hz to 10 MHz Duty cycle: 20 to 80% Duty cycle resolution: Larger of 1% or 10 ns Pulse width: 20 ns minimum Rise/fall time: 18 ns (10 to 90%) Pulse width resolution: 10 ns or 5 digits, whichever is larger Overshoot: $< 2\%$ Asymmetry (at 50% DC): $\pm 1\% \pm 5$ ns Jitter (TIE RMS): 500 ps
Ramp/triangle wave	Frequency range: 0.1 Hz to 200 kHz Linearity: 1% Variable symmetry: 0 to 100% Symmetry resolution: 1%
Noise	Bandwidth: 20 MHz typical
Sine Cardinal (Sinc)	Frequency range: 0.1 Hz to 1.0 MHz
Exponential Rise/Fall	Frequency range: 0.1 Hz to 5.0 MHz
Cardiac	Frequency range: 0.1 Hz to 200.0 kHz
Gaussian Pulse	Frequency range: 0.1 Hz to 5.0 MHz
Arbitrary	Waveform length: 1 to 8k points Amplitude resolution: 10 bits (including sign bit) <sup>1</sup> Repetition rate: 0.1 Hz to 12 MHz Sample rate: 100 MSa/s Filter bandwidth: 20 MHz
Frequency	Sine wave and ramp accuracy: 130 ppm (frequency $< 10$ kHz) 50 ppm (frequency $> 10$ kHz)
	Square wave and pulse accuracy: [50+frequency/200] ppm (frequency $< 25$ kHz) 50 ppm (frequency $\geq 25$ kHz)
	Resolution: 0.1 Hz or 4 digits, whichever is larger
Amplitude	Range: 20 mVpp to 5 Vpp into Hi-Z <sup>2</sup> 10 mVpp to 2.5 Vpp into 50 $\Omega$ <sup>2</sup>
	Resolution: 100 $\mu$ V or 3 digits, whichever is higher

**WaveGen – Built-in Function/Arbitrary Waveform Generator (specifications are typical)**

	Accuracy: 2% (frequency = 1 kHz)
DC offset	Range:
	$\pm 2.5$ V into Hi-Z <sup>2</sup>
	$\pm 1.25$ V into 50 $\Omega$ <sup>2</sup>
	Resolution: 100 $\mu$ V or 3 digits, whichever is higher
	Accuracy (waveform modes): $\pm 1.5\%$ of offset setting $\pm 1\%$ of amplitude $\pm 1$ mV
Accuracy (DC mode): $\pm 1.5\%$ of offset setting $\pm 3$ mV	
Trigger output	Trigger output available on Trig out BNC
Main output	Impedance: 50 $\Omega$ typical
	Isolation: Not available, main output BNC is grounded
	Protection: Overload automatically disables output
Output mode	Normal
	Single-shot (arbitrary, sine, ramp, sine cardinal, exp rise/fall, cardiac, Gaussian pulse)

**Digital voltmeter (specifications are typical)**

Functions	ACrms, DC, DCrms
Resolution	ACV/DCV: 3 digits
Measuring rate	100 times/second
Autoranging	Automatic adjustment of vertical amplification to maximize the dynamic range of measurements
Range meter	Graphical display of most recent measurement, plus extrema over the previous 3 seconds

**Precision Counter/Totalizer (specification are typical)**

Counter	Source	Any analog channel or trigger qualified event
	Resolution	8 digits (8 digits for trigger qualified event)
	Max frequency	1 GHz
	Trig qual events	1/(trigger hold off time) for trigger qualified events (max 25 MHz, minimum dead time of 40 ns)
Measurement		Frequency, period, totalize
Totalizer	Counter size	64-bit totalizing counter
	Edge	Rise or fall
	Gating	Positive or negative level. Select from analog channels except the source

1. Full resolution is not available at output due to internal attenuator stepping.
2. Gaussian Pulse: 4 Vpp maximum into Hi-Z; 2 Vpp maximum into 50  $\Omega$ .

<b>Connectivity</b>	
Standard ports	One USB 2.0 hi-speed device port on rear panel. Supports USBTMC protocol
	Two USB 2.0 hi-speed host ports, front and rear panel
	Supports memory devices, printers and keyboards
Optional ports	GPIB, LAN (10/100Base-T), WVGA video out
Trigger out	BNC connector on the rear panel. Supported modes: triggers, mask, and waveform generator sync pulse
<b>General and environmental characteristics</b>	
Power line consumption	Max 100 W
Power voltage range	100 to 120 V, 50/60/400 Hz; 100 to 240 V, 50/60 Hz
Environmental rating	5 to 50 °C with 4000m max Maximum Relative Humidity: 95%RH up to 40 °C From 40°C to 50°C, the maximum % Relative Humidity follows the line of constant dew point
Electromagnetic compatibility	Meets EMC directive (2004/108/EC), meets or exceeds IEC 61326-1:2005/EN 61326-1:2006 Group 1 Class A requirement CISPR 11/EN 55011 IEC 61000-4-2/EN 61000-4-2 IEC 61000-4-3/EN 61000-4-3 IEC 61000-4-4/EN 61000-4-4 IEC 61000-4-5/EN 61000-4-5 IEC 61000-4-6/EN 61000-4-6 IEC 61000-4-11/EN 61000-4-11 Canada: ICES-001:2004 Australia/New Zealand: AS/NZS
Safety	ANSI/UL Std. No. 61010-1:2012; CAN/CSA-C22.2 No. 61010-1-12
	ANSI/UL Std. No. 61010-2-030:2012; CAN/CSA-C22.2 No. 61010-2-030-12
Vibration	Meets IEC60068-2-6 and MIL-PRF-28800; class 3 random
Shock	Meets IEC 60068-2-27 and MIL-PRF-28800; class 3 random; (Operating 30 g, ½ sine. 11 ms duration, 3 shocks/axis along major axis, total of 18 shocks
Dimensions (W x H x D)	381 mm (15 in) x 204 mm (8 in) x 142 mm (5.6 in)
Weight	Net: 4.0 kg (9.0 lbs.), shipping: 4.2 kg (9.2 lbs.)

Nonvolatile storage		
Reference waveform display		Two internal waveforms or USB thumb drive. Displays 1 reference waveform at a time
Data/file save	Setup/image	Setup (*.scp), 8 or 24-bit Bitmap image (*.bmp), PNG 24-bit image (*.png)
	Waveform data	CSV data (*.csv), ASCII XY data (*.csv), Binary data (*.bin), Lister data (*.csv), Reference waveform data (*.h5), multi-channel waveform data (*.h5), Arbitrary Waveform data (*.csv)
	Application data	Mask (*.msk), Power harmonics data (*.csv), USB signal quality (*.html & *.bmp)
	Analysis results (*.csv)	Cursor data, measurement results, mask test statistics, search, segmented timestamps
Max USB flash drive size		Supports industry standard flash drives
Set ups without USB flash drive		10 internal setups
Set ups with USB flash drive		Limited by size of USB drive
Included standard with oscilloscope		
Calibration		Soft copy of Certificate of Calibration (CoC) with measurement results downloadable from <a href="https://service.keysight.com/infoline/public/details.aspx?i=DOC">https://service.keysight.com/infoline/public/details.aspx?i=DOC</a> , 3-year calibration interval
Mean time before failure (MTBF)		> 250,000 hours
Standard secure erase		
Probes		
N2843A Passive probe 500 MHz 10:1 attenuation		1 per channel
N2756A 16 digital channel MSO cable		1 per scope included on all MSO models and DSOXT3MSO
Interface and built-in help language support		English, Chinese (simplified), Chinese (traditional), Czech, French, German, Italian, Japanese, Korean, Portuguese, Russian, Spanish, Polish, Thai, Turkish
Documentation		CD containing localized user's guide, service guide, and programmer's manual
Localized power cord and overlay		

For MET/CAL procedures, click on the Cal Labs solutions link

<http://www.callabsolutions.com/products/Keysight/>. These procedures are FREE to customers.

## Related Literatures

Publication title	Publication number
Triggering on Infrequent Anomalies and Complex Signals using Zone Trigger - Application Note	5991-1107EN
InfiniiVision 3000T X-Series Oscilloscopes - Product Fact Sheet	5992-0150EN
Time Gated Fast Fourier Transforms for Time Correlated Mixed Domain Analysis - Application Note	5992-0244EN
Embedded Software Package - Data Sheet	5992-3924EN
Automotive Software Package - Data Sheet	5992-3912EN
Aero Software Package - Data Sheet	5992-3910EN
Power Software Package - Data Sheet	5992-3925EN
NFC Software Package - Data Sheet	5992-3911EN
USB Software Package - Data Sheet	5992-3920EN
Ultimate Bundle Software Package - Data Sheet	5992-3918EN

# After-purchase License-only Upgrades

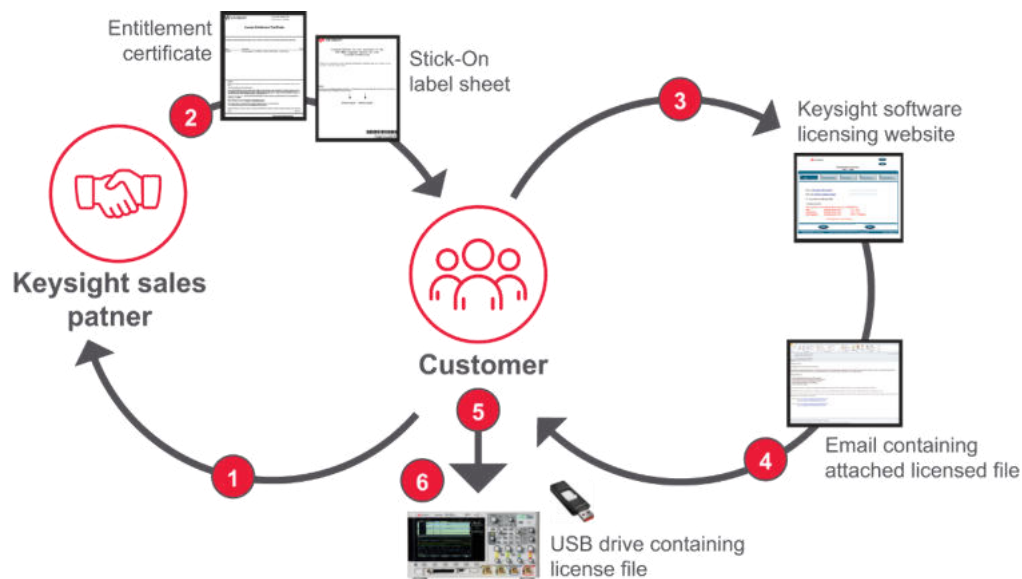

1. Place order for a license only upgrade to a Keysight sales partner. If multiple bandwidth upgrade steps are needed, order all the corresponding upgrade products required to get from current bandwidth to desired bandwidth.
2. For software packages, you will receive a paper or electronic .pdf Entitlement Certificate. For bandwidth upgrades only, you will receive a stick-on label document indicating upgraded bandwidth specification in addition to a paper Entitlement Certificate.
3. Use Entitlement Certificate containing instructions and certificate number needed to generate a license file for a particular 3000T X-Series oscilloscope model number and serial number unit.
4. Receive the licensed file and installation instructions via email.
5. Copy license file (.lic extension) from email to a USB drive and follow instructions in email to install the purchased bandwidth upgrade or measurement application on the oscilloscope.
6. For bandwidth upgrades only, attach bandwidth upgraded stick-on label to front and rear panels of the oscilloscope. Model number and serial number of the oscilloscope do not change.

## Software upgrades

Model number	Description
D3000GENB	Embedded Software Package: I2C, SPI, UART (RS232/422/485), I2S, and USB PD serial trigger and decode, plus Measurement Limit Testing, Mask Limit Testing, Frequency Response Analysis (Bode plots), and Enhanced Video Analysis
D3000AUTB	Automotive Software Package: CAN, CAN FD, LIN, FlexRay, SENT, CXPI, PSi5 (User-definable Manchester), and User-definable NRZ serial trigger & decode, plus Measurement Limit Testing, Mask Limit Testing, and Frequency Response Analysis (Bode plots)
D3000AERB	Aero Software Package: MIL-STD 1553 and ARINC 429 serial trigger and decode, plus Measurement Limit Testing, Measurement Limit Testing, Mask Limit Testing, Frequency Response Analysis (Bode plots), and Enhanced Video Analysis
D3000PWRB	Power Software Package: Power quality, current harmonics, switching loss, turn-on/off time, transient response, loop response, PSRR, & more, plus Measurement Limit Testing, Mask List Testing, Frequency Response Analysis (Bode plots), and USB PD serial trigger & decode
D3000NFCB	NFC Software Package: NFC triggering and PC-based NFC automated test software
D3000BDLB	Ultimate Bundle Software Package: I <sup>2</sup> C, SPI, UART, I2S, CAN, CAN FD LIN, FlexRay, CXPI, PSi5 (User-definable Manchester), User-definable NRZ, MIL-STD 1553, ARINC 429 and USB PD serial trigger & decode, plus Power Analysis, Measurement Limit Testing, Mask Limit Testing, Frequency Response Analysis (Bode plots), Enhanced Video Analysis, NFC trigger and automated test software

## Hardware upgrades <sup>1</sup>

Model number	Description
DSOX3WAVEGEN	Built-in 20 MHz function/AWG waveform generator upgrade (license only)
DSOXT3MSO	MSO upgrade: Add 16 digital timing channels (N2756A MSO cable delivered separately)
DSOXT3SECA	Enhanced security option
DSOXT3B1T22	Bandwidth upgrade from 100 to 200 MHz, 2-ch models (license only)
DSOXT3B1T24	Bandwidth upgrade from 100 to 200 MHz, 4-ch models (license only)
DSOXT3B3T52	Bandwidth upgrade from 350 to 500 MHz, 2-ch models (license only)
DSOXT3B3T54	Bandwidth upgrade from 350 to 500 MHz, 4-ch models (license only)

1. See next page for return-to-Keysight service center upgrade process for these products.

# Return-to-Keysight Service Center Bandwidth Upgrades

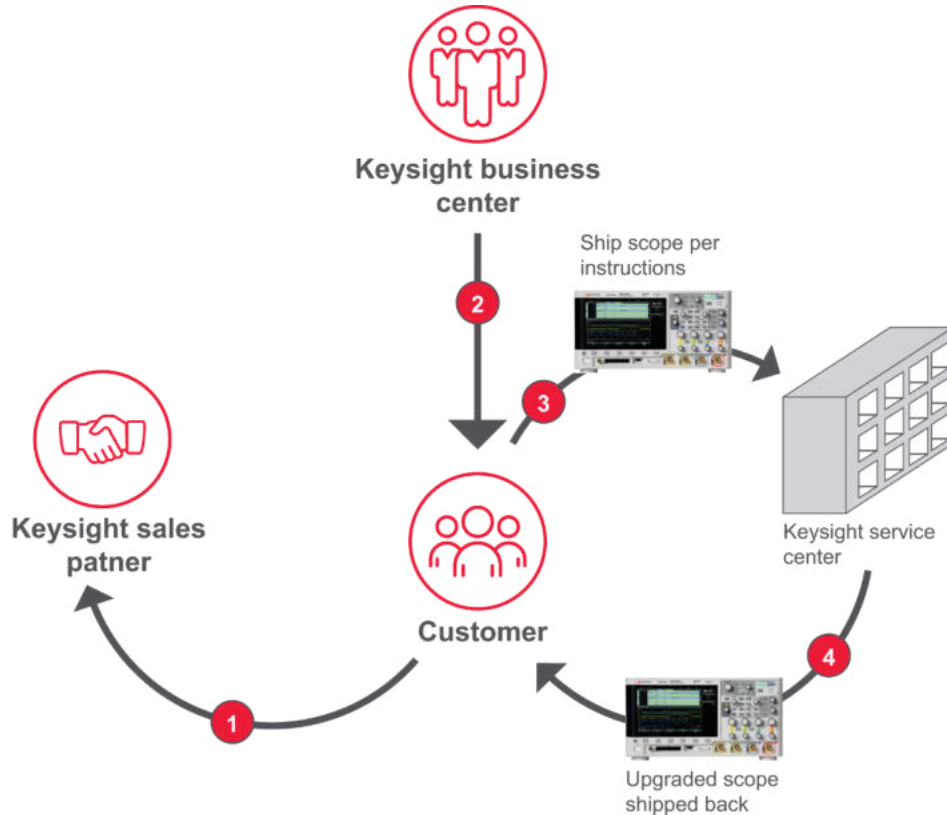

1. Place order for a return-to-Keysight Service Center bandwidth upgrade product to a Keysight sales partner. Shipment costs are in addition to bandwidth upgrade product price.
2. Keysight Business Center will contact you regarding process and timing of the Service Center installation. Continue to use oscilloscope until contacted again later when parts are available at Service Center.
3. Ship the oscilloscope per provided instructions to Service Center.
4. Service Center ships back upgraded oscilloscope with stick-on labels applied to front and rear panels indicating upgraded bandwidth specification. Model number and serial number of the oscilloscope do not change.

## Return-to-Keysight Bandwidth Upgrade

Model number	Description
DSOXT3B1T32U	Service center 100 to 350 MHz upgrade, 2 ch
DSOXT3B1T52U	Service center 100 to 500 MHz upgrade, 2 ch
DSOXT3B1T102U	Service center 100 to 1 GHz upgrade, 2 ch
DSOXT3B1T34U	Service center 100 to 350 MHz upgrade, 4 ch
DSOXT3B1T54U	Service center 100 to 500 MHz upgrade, 4 ch
DSOXT3B1T104U	Service center 100 to 1 GHz upgrade, 4 ch
DSOXT3B2T32U	Service center 200 to 350 MHz upgrade, 2 ch
DSOXT3B2T52U	Service center 200 to 500 MHz upgrade, 2 ch
DSOXT3B2T102U	Service center 200 MHz to 1 GHz upgrade, 2 ch
DSOXT3B2T34U	Service center 200 to 350 MHz upgrade, 4 ch
DSOXT3B2T54U	Service center 200 to 500 MHz upgrade, 4 ch
DSOXT3B2T104U	Service center 200 MHz to 1 GHz upgrade, 4 ch
DSOXT3B3T102U	Service center 350 MHz to 1 GHz upgrade, 2 ch
DSOXT3B3T104U	Service center 350 MHz to 1 GHz upgrade, 4 ch
DSOXT3B5T102U	Service center 500 MHz to 1 GHz upgrade, 2 ch
DSOXT3B5T104U	Service center 500 MHz to 1 GHz upgrade, 4 ch

## Download Your Next Insight

Keysight software is downloadable expertise. From first simulation through first customer shipment, we deliver the tools your team needs to accelerate from data to information to actionable insight.

- Electronic design automation (EDA) software
- Application software
- Programming environments
- Productivity software

Learn more at [www.keysight.com/find/software](http://www.keysight.com/find/software)

Start with a 30-day free trial [www.keysight.com/find/free\\_trials](http://www.keysight.com/find/free_trials)

## Keysight Oscilloscopes

- Multiple form factors from 50 MHz to 110 GHz
- Industry leading specs
- Powerful applications



For more information on Keysight Technologies' products, applications, or services, please visit: [www.keysight.com](http://www.keysight.com)



This information is subject to change without notice. © Keysight Technologies, 2018 - 2022, Published in USA, July 5, 2022, 5992-0140EN