U1253B

True RMS OLED Multimeter

Notices

Copyright Notice

© Keysight Technologies 2009 - 2023

No part of this manual may be reproduced in any form or by any means (including electronic storage and retrieval or translation into a foreign language) without prior agreement and written consent from Keysight Technologies as governed by United States and international copyright laws.

Manual Part Number

U1253-90035

Edition

Edition 24, February 2023

Printed in:

Printed in Malaysia

Published by:

Keysight Technologies
Bayan Lepas Free Industrial Zone,
11900 Penang, Malaysia

Technology Licenses

The hardware and/or software described in this document are furnished under a license and may be used or copied only in accordance with the terms of such license.

Declaration of Conformity

Declarations of Conformity for this product and for other Keysight products may be downloaded from the Web. Go to <http://www.keysight.com/go/conformity>. You can then search by product number to find the latest Declaration of Conformity.

U.S. Government Rights

The Software is “commercial computer software,” as defined by Federal Acquisition Regulation (“FAR”) 2.101. Pursuant to FAR 12.212 and 27.405-3 and Department of Defense FAR Supplement (“DFARS”) 227.7202, the U.S. government acquires commercial computer software under the same terms by which the software is customarily provided to the public. Accordingly, Keysight provides the Software to U.S. government customers under its standard commercial license, which is embodied in its End User License Agreement (EULA), a copy of which can be found at <http://www.keysight.com/find/sweula>. The license set forth in the EULA represents the exclusive authority by which the U.S. government may use, modify, distribute, or disclose the Software. The EULA and the license set forth therein, does not require or permit, among other things, that Keysight: (1) Furnish technical information related to commercial computer software or commercial computer software documentation that is not customarily provided to the public; or (2) Relinquish to, or otherwise provide, the government rights in excess of these rights customarily provided to the public to use, modify, reproduce, release, perform, display, or disclose commercial computer software or commercial computer software documentation. No additional government requirements beyond those set forth in the EULA shall apply, except to the extent that those terms, rights, or licenses are explicitly required from all providers of commercial computer software pursuant to the FAR and the DFARS and are set forth specifically in writing elsewhere in the EULA. Keysight shall be under no obligation to update, revise or otherwise modify the Software. With respect to any technical data as defined by FAR 2.101, pursuant to FAR 12.211 and 27.404.2 and DFARS 227.7102, the U.S. government acquires no greater than Limited Rights as defined in FAR 27.401 or DFAR 227.7103-5 (c), as applicable in any technical data.

Warranty

THE MATERIAL CONTAINED IN THIS DOCUMENT IS PROVIDED “AS IS,” AND IS SUBJECT TO BEING CHANGED, WITHOUT NOTICE, IN FUTURE EDITIONS. FURTHER, TO THE MAXIMUM EXTENT PERMITTED BY APPLICABLE LAW, KEYSIGHT DISCLAIMS ALL WARRANTIES, EITHER EXPRESS OR IMPLIED, WITH REGARD TO THIS MANUAL AND ANY INFORMATION CONTAINED HEREIN, INCLUDING BUT NOT LIMITED TO THE IMPLIED WARRANTIES OF MERCHANTABILITY AND FITNESS FOR A PARTICULAR PURPOSE. KEYSIGHT SHALL NOT BE LIABLE FOR ERRORS OR FOR INCIDENTAL OR CONSEQUENTIAL DAMAGES IN CONNECTION WITH THE FURNISHING, USE, OR PERFORMANCE OF THIS DOCUMENT OR OF ANY INFORMATION CONTAINED HEREIN. SHOULD KEYSIGHT AND THE USER HAVE A SEPARATE WRITTEN AGREEMENT WITH WARRANTY TERMS COVERING THE MATERIAL IN THIS DOCUMENT THAT CONFLICT WITH THESE TERMS, THE WARRANTY TERMS IN THE SEPARATE AGREEMENT SHALL CONTROL.

Safety Information

CAUTION

















A CAUTION notice denotes a hazard. It calls attention to an operating procedure, practice, or the like that, if not correctly performed or adhered to, could result in damage to the product or loss of important data. Do not proceed beyond a CAUTION notice until the indicated conditions are fully understood and met.

WARNING

A WARNING notice denotes a hazard. It calls attention to an operating procedure, practice, or the like that, if not correctly performed or adhered to, could result in personal injury or death. Do not proceed beyond a WARNING notice until the indicated conditions are fully understood and met.

Safety Symbols

The following symbols on the instrument and in the documentation indicate precautions that must be taken to maintain safe operation of the instrument.

	Direct current (DC)		Off (supply)
	Alternating current (AC)		On (supply)
	Both direct and alternating current		Caution, risk of electric shock
	Three-phase alternating current		Caution, risk of danger (refer to this manual for specific Warning or Caution information)
	Earth (ground) terminal		Caution, hot surface
	Protective conductor terminal		Out position of a bi-stable push control
	Frame or chassis terminal		In position of a bi-stable push control
	Equipotentiality	CAT III 1000 V	Category III 1000 V overvoltage protection
	Equipment protected throughout by double insulation or reinforced insulation	CAT IV 600 V	Category IV 600 V overvoltage protection

General Safety Information

The following general safety precautions must be observed during all phases of operation, service, and repair of this instrument. Failure to comply with these precautions or with specific warnings elsewhere in this manual violates safety standards of design, manufacture, and intended use of the instrument. Keysight Technologies assumes no liability for the customer's failure to comply with these requirements.

CAUTION

- Turn off the circuit power and discharge all high-voltage capacitors in the circuit before you perform resistance and capacitance measurements or continuity and diodes tests.
 - Use the correct terminals, function, and range for your measurements.
 - Never measure voltage when current measurement is selected.
 - Use only the recommended rechargeable battery. Ensure proper insertion of battery in the multimeter, and follow the correct polarity.
 - Disconnect test leads from all the terminals during battery charging.
-

WARNING

- Do not exceed any of the measurement limits defined in the specifications to avoid instrument damage and the risk of electric shock.
 - When working above 60 VDC, 30 VAC rms, or 42.4 VAC peak, exercise caution – such range poses a shock hazard.
 - Do not measure more than the rated voltage (as marked on the multimeter) between terminals, or between terminal and earth ground.
 - Double-check the meters operation by measuring a known voltage.
 - For current measurement, turn off circuit power before connecting the multimeter to the circuit. Always place the multimeter in series with the circuit.
 - When connecting probes, always connect the common test probe first. When disconnecting probes, always disconnect the live test probe first.
 - Detach test probes from the multimeter before you open the battery cover.
 - Do not use the multimeter with the battery cover or part of the cover removed or loose.
 - Replace the battery as soon as the low battery indicator flashes on screen. This is to avoid false readings, which may lead to possible electric shock or personal injury.
 - Do not operate the product in an explosive atmosphere or in the presence of flammable gases or fumes, vapor, or wet environments.
 - Inspect the case for cracks or missing plastic. Pay extra attention to the insulation surrounding the connectors. Do not use the multimeter if it is damaged.
 - Inspect the test probes for damaged insulation or exposed metal, and check for continuity. Do not use the test probe if it is damaged.
 - Do not use any other AC charger adapter apart from the one certified by Keysight with this product.
-

WARNING

- Do not use repaired fuses or short-circuited fuse-holders. For continued protection against fire, replace the line fuses only with fuses of the same voltage and current rating and recommended type.
 - Do not service or perform adjustments alone. Under certain condition, hazardous voltages may exist, even with the equipment switched off. To avoid dangerous electric shock, service personnel must not attempt internal service or adjustment unless another person, capable of rendering resuscitation or first aid, is present.
 - Do not substitute parts or modify equipment to avoid the danger of introducing additional hazards. Return the product to the nearest Keysight Technologies Sales and Service office for service and repair to ensure the safety features are maintained.
 - Do not operate damaged equipment as the safety protection features built into this product may have been impaired, either through physical damage, excessive moisture, or any other reason. Remove power and do not use the product until safe operation can be verified by service-trained personnel. If necessary, return the product to the nearest Keysight Technologies Sales and Service office for service and repair to ensure the safety features are maintained.
-

Environmental Conditions

This instrument is designed for indoor use and in areas with low condensation. The table below shows the general environmental requirements for this instrument.





Environmental conditions	Requirements
Operating temperature	Full accuracy from -20 °C to 55 °C
Operating humidity	Full accuracy up to 80% R.H. (relative humidity) for temperature up to 35 °C, decreasing linearly to 50% R.H. at 55 °C
Storage temperature	-40 °C to 70 °C (with battery removed)
Altitude	Up to 2000 m
Pollution degree	Pollution Degree 2

Product Regulatory and Compliance

This U1253B True RMS OLED Multimeter complies with safety and EMC requirements.

Refer to Declaration of Conformity at <http://www.keysight.com/go/conformity> for the latest revision.

Regulatory Markings

 <p>The CE mark is a registered trademark of the European Community. This CE mark shows that the product complies with all the relevant European Legal Directives.</p>	 <p>The RCM mark is a registered trademark of the Spectrum Management Agency of Australia. This signifies compliance with the Australia EMC Framework regulations under the terms of the Radio Communication Act of 1992.</p>
<p>ICES/NMB-001</p> <p>ICES/NMB-001 indicates that this ISM device complies with the Canadian ICES-001. Cet appareil ISM est conforme a la norme NMB-001 du Canada.</p>	 <p>This instrument complies with the WEEE Directive (2002/96/EC) marking requirement. This affixed product label indicates that you must not discard this electrical/electronic product in domestic household waste.</p>
 <p>The CSA mark is a registered trademark of the Canadian Standards Association.</p>	<div style="background-color: #cccccc; height: 100px;"></div>

Waste Electrical and Electronic Equipment (WEEE) Directive 2002/96/EC

This instrument complies with the WEEE Directive (2002/96/EC) marking requirement. This affixed product label indicates that you must not discard this electrical or electronic product in domestic household waste.

Product category

With reference to the equipment types in the WEEE directive Annex 1, this instrument is classified as a “Monitoring and Control Instrument” product.

The affixed product label is as shown below.



Do not dispose in domestic household waste.

To return this unwanted instrument, contact your nearest Keysight Service Center, or visit <http://about.keysight.com/en/companyinfo/environment/takeback.shtml> for more information.

Sales and Technical Support

To contact Keysight for sales and technical support, refer to the support links on the following Keysight websites:

- www.keysight.com/find/xxxxx
(product-specific information and support, software and documentation updates)
- www.keysight.com/find/assist
(worldwide contact information for repair and service)

In This Guide...

1 Getting Started

This chapter contains information on the U1253B true RMS OLED multimeter front panel, rotary switch, keypad, display, terminals and rear panel.

2 Making Measurements

This chapter contains information on how to make measurements using the U1253B true RMS OLED multimeter.

3 Functions and Features

This chapter contains information on the functions and features available for the U1253B true RMS OLED multimeter.

4 Changing the Default Settings

This chapter will show you how to change the default factory settings of the U1253B true RMS OLED multimeter and other available setting options.

5 Maintenance

This chapter will help you to troubleshoot if the U1253B true RMS OLED multimeter malfunctions.

6 Performance Tests and Calibration

This chapter contains the performance test and adjustment procedures.

7 Specifications

This chapter lists the product characteristics, specification assumptions and the specifications of the U1253B true RMS OLED multimeter.

Table of Contents

Safety Symbols	3
General Safety Information	4
Environmental Conditions	7
Product Regulatory and Compliance	7
Regulatory Markings	8
Waste Electrical and Electronic Equipment (WEEE) Directive 2002/96/ EC	9
Product category	9
Sales and Technical Support	9
In This Guide...	10
1 Getting Started	
Introducing the Keysight U1253B True RMS OLED Multimeter	22
Check the shipment	23
Installing the battery	24
Adjusting the tilt-stand	26
The front panel at a glance	29
The rear panel at a glance	30
The rotary switch at a glance	31
The keypad at a glance	32
The display at a glance	36
Selecting display with the Shift button	42
Selecting display with the Dual button	44
Selecting display with the Hz button	47
The terminals at a glance	49
2 Making Measurements	
Understanding The Measurement Instructions	52
Measuring Voltage	52

Measuring AC voltage	53
Measuring DC voltage	54
Measuring AC and DC Signals	56
Measuring Current	57
μ A and mA measurement	57
Percentage scale of 4 mA to 20 mA	59
A (ampere) measurement	61
Frequency Counter	62
Measuring Resistance, Conductance, and Testing Continuity	64
Testing Diodes	71
Measuring Capacitance	74
Measuring Temperature	76
Alerts and Warning During Measurement	80
Overload alert	80
Input warning	81
Charge terminal alert	82

3 Functions and Features

Dynamic Recording	84
Data Hold (Trigger Hold)	86
Refresh Hold	88
Null (Relative)	90
Decibel Display	92
1 ms Peak Hold	95
Data Logging	97
Manual logging	97
Interval logging	99
Reviewing logged data	101
Square Wave Output	103
Remote Communication	107

4 Changing the Default Settings

Selecting Setup Mode	110
Default Factory Settings and Available Setting Options	111
Setting Data Hold/Refresh Hold mode	115
Setting data logging mode	116
Setting dB measurement	118
Setting reference impedance for dBm measurement	119
Setting thermocouple types	120
Setting temperature unit	120
Setting percentage scale readout	122
Sound setting for continuity test	123
Setting minimum measurable frequency	124
Setting beep frequency	125
Setting Auto Power Off mode	126
Setting power-on backlight brightness level	128
Setting the power-on melody	129
Setting the power-on greeting screen	129
Setting baud rate	130
Setting data bits	131
Setting parity check	132
Setting echo mode	133
Setting print mode	134
Revision	135
Serial number	135
Voltage alert	136
M-initial	137
Smooth refresh rate	141
Returning to default factory settings	142
Setting the battery type	143
Setting the Filter	144

5 Maintenance

Introduction	146
General maintenance	146
Battery replacement	147
Storage considerations	149
Charging the battery	150

Fuse checking procedure	157
Fuse replacement	159
Troubleshooting	161
Replaceable Parts	163
To order replaceable parts	163
6 Performance Tests and Calibration	
Calibration Overview	166
Closed-case electronic calibration	166
Keysight Technologies' calibration services	166
Calibration interval	167
Other recommendations for calibration	167
Recommended Test Equipment	168
Basic Operating Tests	169
Testing the display	169
Current terminals test	170
Charge terminals alert test	171
Test Considerations	172
Performance Verification Tests	173
Calibration Security	180
Unsecuring the instrument for calibration	180
Changing Calibration Security Code	183
Resetting the security code to factory default	185
Adjustment Considerations	187
Valid adjustment reference input values	188
Calibration From Front Panel	192
Calibration process	192
Calibration procedures	193
Calibration count	200
Calibration error codes	201
7 Specifications	

List of Figures

Figure 1-1	Tilt-stand at 60°	26
Figure 1-2	Tilt-stand at 30°	27
Figure 1-3	Tilt-stand at hanging position	28
Figure 1-4	U1253B front panel	29
Figure 1-5	Rear panel	30
Figure 1-6	Rotary switch	31
Figure 1-7	U1253B keypad	32
Figure 1-8	Connector terminals	49
Figure 2-1	Measuring AC voltage	53
Figure 2-2	Measuring DC voltage	55
Figure 2-3	Measuring μA and mA current	58
Figure 2-4	Measurement scale of 4 mA to 20 mA	60
Figure 2-5	A (ampere) current measurement	61
Figure 2-6	Measuring frequency	63
Figure 2-7	Type of display when Smart Ω is enabled	65
Figure 2-8	Measuring resistance	66
Figure 2-9	Resistance, audible continuity, and conductance tests	67
Figure 2-10	Short continuity and open continuity test	69
Figure 2-11	Conductance measurement	70
Figure 2-12	Measuring the forward bias of a diode	72
Figure 2-13	Measuring the reverse bias of a diode	73
Figure 2-14	Capacitance measurements	75
Figure 2-15	Connecting the thermal probe into the non-compensation transfer adapter	77
Figure 2-16	Connecting the probe with adapter into the multimeter	77
Figure 2-17	Surface temperature measurement	79
Figure 2-18	Input terminal warning	81
Figure 2-19	Charge terminal alert	82
Figure 3-1	Dynamic recording mode operation	85
Figure 3-2	Data hold mode operation	87
Figure 3-3	Refresh hold mode operation	89
Figure 3-4	Null (relative) mode operation	91

Figure 3-5	dBm display mode operation	93
Figure 3-6	dBV display mode operation	94
Figure 3-7	1 ms peak hold mode operation	96
Figure 3-8	Manual (hand) logging mode operation	98
Figure 3-9	Full log	98
Figure 3-10	Interval (time) logging mode operation	100
Figure 3-11	Log review mode operation	102
Figure 3-12	Frequency adjustment for square wave output	104
Figure 3-13	Duty cycle adjustment for square wave output	105
Figure 3-14	Pulse width adjustment for square wave output	106
Figure 3-15	Cable connection for remote communication	107
Figure 4-1	Setup menu screens	114
Figure 4-2	Data Hold/Refresh Hold setup	115
Figure 4-3	Data logging setup	116
Figure 4-4	Log time setup for interval (time) logging	117
Figure 4-5	Decibel measurement setup	118
Figure 4-6	Setting up the reference impedance for dBm unit	119
Figure 4-7	Thermocouple type setup	120
Figure 4-8	Temperature unit setup	121
Figure 4-9	Setting up percentage scale readout	122
Figure 4-10	Choosing the sound used in continuity test	123
Figure 4-11	Minimum frequency setup	124
Figure 4-12	Beep frequency setup	125
Figure 4-13	Automatic power saving setup	127
Figure 4-14	Power-on backlight setup	128
Figure 4-15	Power-on melody setup	129
Figure 4-16	Power-on greeting setup	129
Figure 4-17	Baud rate setup for remote control	130
Figure 4-18	Data bits setup for remote control	131
Figure 4-19	Parity check setup for remote control	132
Figure 4-20	Echo mode setup for remote control	133
Figure 4-21	Print mode setup for remote control	134
Figure 4-22	Revision number	135
Figure 4-23	Serial number	135
Figure 4-24	Voltage alert setup	136
Figure 4-25	Setting initial measurement functions	138
Figure 4-26	Navigating between the initial functions pages	139

Figure 4-27	Editing initial measurement function/range	139
Figure 4-28	Editing initial measurement function/range and initial output values	140
Figure 4-29	Refresh rate for primary display readings	141
Figure 4-30	Resetting to default factory settings	142
Figure 4-31	Battery type selection	143
Figure 4-32	Filter	144
Figure 5-1	9 V rectangular battery	147
Figure 5-2	Rear panel of the Keysight U1253B True RMS OLED Multimeter	148
Figure 5-3	Self-testing time display	152
Figure 5-4	Performing self-test	153
Figure 5-5	Charging mode	154
Figure 5-6	Fully charged and in the trickle state	155
Figure 5-7	Battery charging procedures	156
Figure 5-8	Fuse checking procedures	157
Figure 5-9	Fuse replacement	160
Figure 6-1	Displaying all OLED pixels	169
Figure 6-2	Current terminal error message	170
Figure 6-3	Charge terminal error message	171
Figure 6-4	Unsecuring the instrument for calibration	182
Figure 6-5	Changing the calibration security code	184
Figure 6-6	Resetting security code to factory default	186
Figure 6-7	Typical calibration process flow	195

THIS PAGE HAS BEEN INTENTIONALLY LEFT BLANK.

List of Tables

Table 1-1	Rotary switch description and functions	31
Table 1-2	Keypad descriptions and functions	33
Table 1-3	General display symbols	36
Table 1-4	Primary display symbols	38
Table 1-5	Secondary display symbols	40
Table 1-6	Analog bar range and counts	41
Table 1-7	Selecting display with the Shift button	42
Table 1-8	Selecting display with the Dual button	44
Table 1-9	Selecting display with the Hz button	47
Table 1-10	Terminal connections for different measurement functions	50
Table 2-1	Numerical steps descriptions	52
Table 2-2	Percentage scale and measurement range	59
Table 2-3	Audible continuity measurement range	68
Table 3-1	Available frequencies for square wave output	103
Table 4-1	Default factory settings and available setting options for each feature	111
Table 4-2	Available settings for M-initial	137
Table 4-3	Firmware version 2.25 or older	144
Table 4-4	Firmware version 2.26 or newer	144
Table 5-1	Battery voltage and corresponding percentage of charges in standby and charging modes	152
Table 5-2	Error messages	153
Table 5-3	U1253B measurement readings for fuse checking	158
Table 5-4	Fuse specifications	160
Table 5-5	Basic troubleshooting procedures	162
Table 6-1	Recommended test equipment	168
Table 6-2	Performance verification tests	174
Table 6-3	Valid adjustment reference input values	188
Table 6-4	List of calibration items	196
Table 6-5	Calibration error codes and their respective meanings	.

THIS PAGE HAS BEEN INTENTIONALLY LEFT BLANK.

1 Getting Started

Introducing the Keysight U1253B True RMS OLED Multimeter	22
Check the shipment	23
Installing the battery	24
Adjusting the tilt-stand	26
The front panel at a glance	29
The rear panel at a glance	30
The rotary switch at a glance	31
The keypad at a glance	32
The display at a glance	36
The terminals at a glance	49

This chapter contains information on the U1253B true RMS OLED multimeter front panel, rotary switch, keypad, display, terminals and rear panel.

Introducing the Keysight U1253B True RMS OLED Multimeter

The key features of the true RMS OLED multimeter are:

- DC, AC and AC+DC voltage and current measurements.
- True RMS measurement for both AC voltage and current.
- Rechargeable Ni-MH battery with built-in charging capability.
- Ambient temperature readout that accompanies most measurement readouts (both in single and dual display modes).
- Battery capacity indicator.
- Bright yellow OLED (Organic Light Emitting Diode) display.
- Resistance measurement up to 500 M Ω .
- Conductance measurement from 0.01 nS (100 G Ω) to 500 nS.
- Capacitance measurement up to 100 mF.
- Frequency counter up to 20 MHz.
- Percentage scale readout for 4–20 mA to 0–20 mA measurement.
- Measurement of dBm with selectable reference impedance.
- 1 ms peak hold to catch in-rush voltage and current easily.
- Temperature test with selectable 0 °C compensation (without ambient temperature compensation).
- J-type or K-type probe for temperature measurement.
- Frequency, duty cycle, and pulse width measurements.
- Dynamic recording for minimum, maximum, average, and present readings.
- Data hold with manual or auto trigger and relative modes.
- Diode and audible continuity tests.
- Square wave generator with selectable frequency, pulse width, and duty cycle.
- Keysight GUI Application Software (IR-USB cable sold separately).
- Closed case calibration.
- 50,000-count precision true RMS digital multimeter, designed to meet EN/IEC 61010-1:2001 Category III 1000 V/ Category IV 600 V, Pollution Degree 2 standards.

Check the shipment

Verify that you have received the following items with your multimeter:

- Test probes
- Test leads
- Alligator clips
- Rechargeable 8.4 V battery
- Power cord & AC adapter
- Certificate of Calibration

Contact your nearest Keysight Sales Office if any of the above are missing.

Inspect the shipping container for damage. Signs of damage may include a dented or torn shipping container or cushioning material that indicates signs of unusual stress or compacting. Save the packaging material in case the multimeter needs to be returned.

Please refer to the [Keysight Handheld Tools](#) brochure (5989-7340EN) for the full and latest list of handheld accessories available.

Installing the battery

Your multimeter is powered by one 9 V battery. When you receive your multimeter, the batteries are not installed.

NOTE

A new rechargeable battery comes in a discharged condition and must be charged before use. Upon initial use (or after a prolonged storage period), the battery may require three to four charge/discharge cycles before achieving maximum capacity. Refer to “**Charging the battery**” on page 150

CAUTION

Before you proceed with the battery installation, remove all cable connections to the terminals and ensure that the rotary switch is at the **OFF** position. Use only the batteries provided with your multimeter.



- 1 Lift the tilt stand.



- 2 On the rear panel, turn the screw on the battery cover counterclockwise from the LOCK position to OPEN.

- 3 Slide the battery cover down and lift the battery cover up to insert the battery.



The battery level indicator in the lower left-hand corner of the display indicates the relative condition of the batteries. Replace the batteries as soon as possible when the low battery indicator ( ↔ ) is shown.

Adjusting the tilt-stand

To adjust the multimeter to a 60° standing position, pull the tilt-stand outward to its maximum reach.

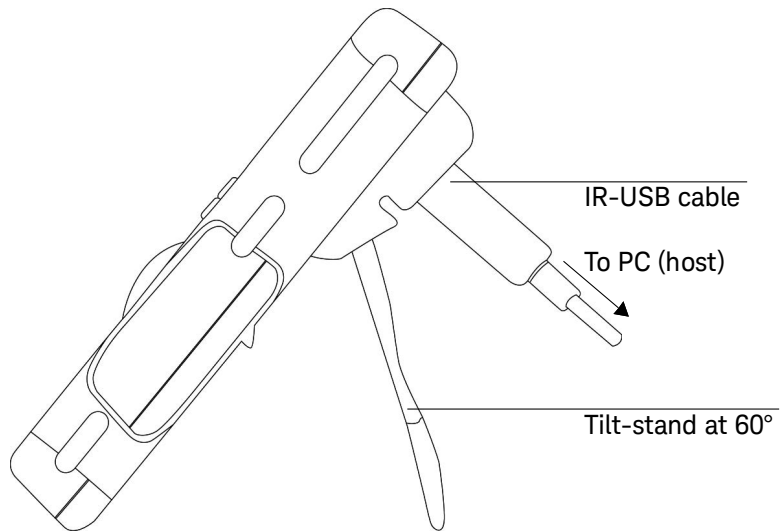

Figure 1-1 Tilt-stand at 60°

To adjust the multimeter to a 30° standing position, bend the tip of the stand so that it is parallel to ground, then pull the stand outward to its maximum reach.

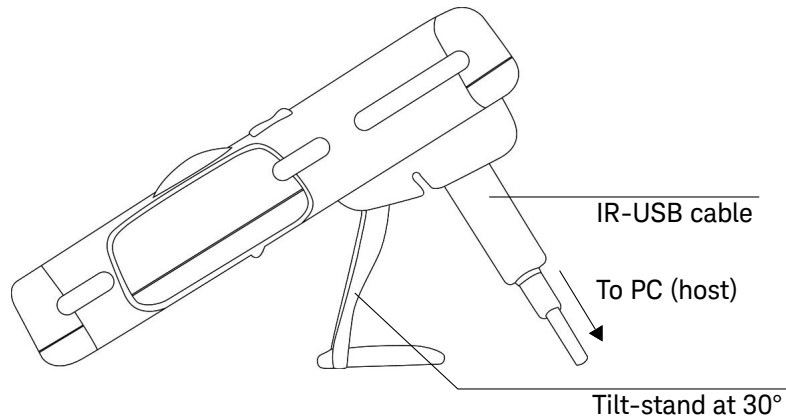

Figure 1-2 Tilt-stand at 30°

To adjust the multimeter to a hanging position, follow these steps below or [Figure 1-3](#) on page 28:

- 1 Flip the stand upward and over its maximum reach until it is detached from its hinge.
- 2 Flip the now detached stand over so that its inner surface is facing the multimeter as opposed to facing you.
- 3 Press the stand down into its hinge in an upright position.

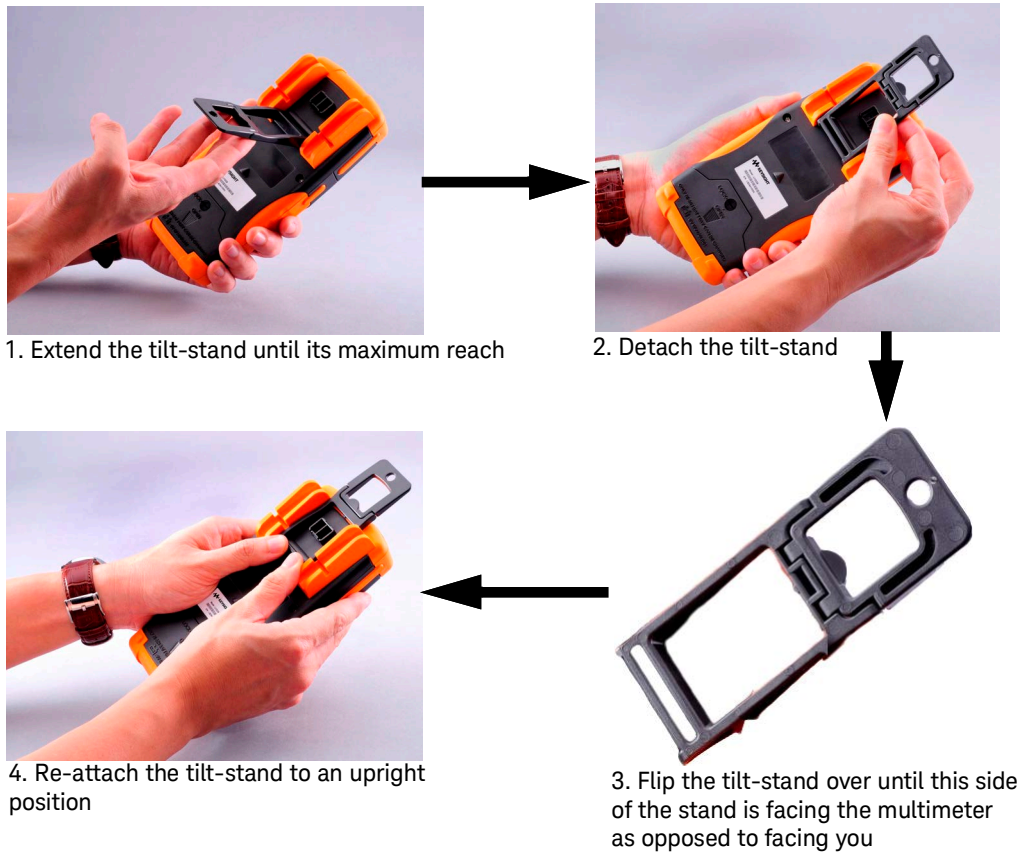

Figure 1-3 Tilt-stand at hanging position

The front panel at a glance



Figure 1-4 U1253B front panel

The rear panel at a glance

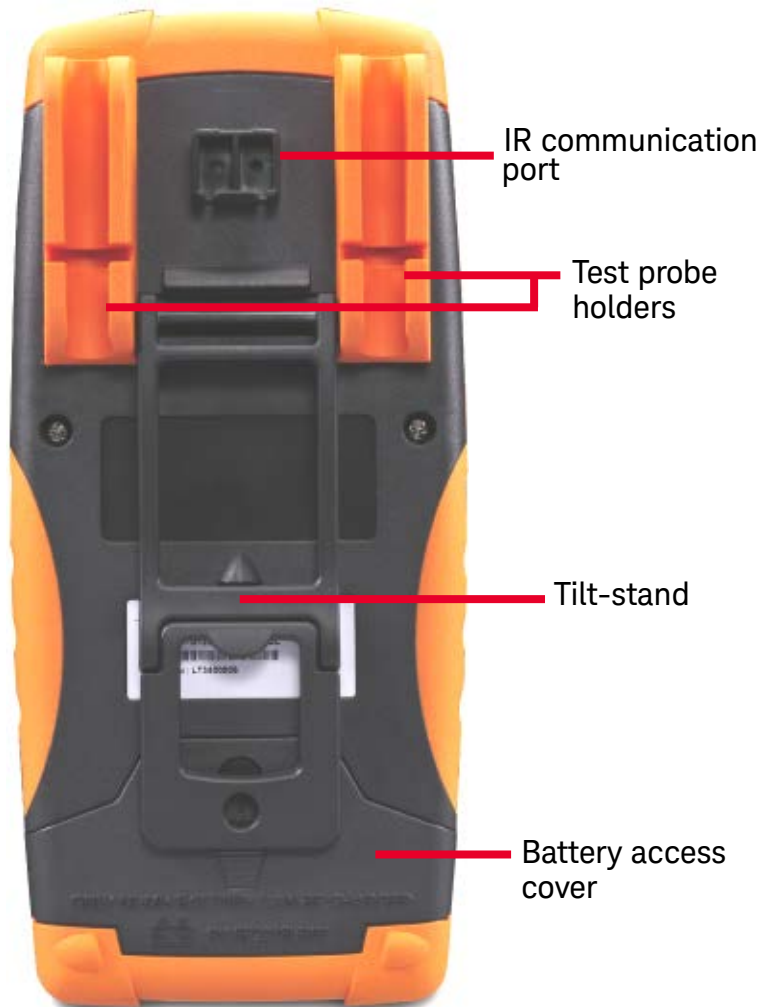

Figure 1-5 Rear panel

The rotary switch at a glance



Figure 1-6 Rotary switch

Table 1-1 Rotary switch description and functions

No.	Description/Function
1	Charge mode or OFF
2	AC V
3	DC V, AC V, or AC + DC V
4	DC mV, AC mV, or AC + DC mV
5	Resistance (Ω), continuity, or conductance (nS)
6	Frequency counter or diode
7	Capacitance or temperature
8	DC μ A, AC μ A, or AC + DC μ A
9	DC mA, DC A, AC mA, AC A, AC + DC mA, or AC + DC A
10	Square wave output, duty cycle, or pulse width output

The keypad at a glance

The operation of each key is explained in [Table 1-2](#) below. Pressing a key displays a related symbol and emits a sound on the beeper. Turning the rotary switch to another position resets the current operation of the key. [Figure 1-7](#) shows the keypad of the U1253B.



Figure 1-7 U1253B keypad

Table 1-2 Keypad descriptions and functions



































Button	Function when pressed for less than 1 second	Function when pressed for more than 1 second
1	  cycles through OLED display brightness levels.	<ul style="list-style-type: none">  enters Log Review mode. Press  to switch between manual or interval logging data. Press  or  to view first or last logged data respectively. Press  or  to scroll through the logged data. Press  for more than 1 second to exit this mode.
2	 -  holds the current measured value. <ul style="list-style-type: none"> In Data Hold mode () , press  again to trigger the holding of the next measured value. Press  for more than 1 second to exit this mode. In Refresh Hold mode () , the reading is updated automatically once the reading is stable and the count setting is exceeded ^[a]. Press  again to exit this mode. 	<ul style="list-style-type: none">  enters the Dynamic Recording mode. Press  again to scroll through maximum, minimum, average, or present readings (indicated by , , , or  on the display). Press  for more than 1 second to exit this mode.
3	 -  saves the displayed value as a reference to be subtracted from subsequent measurements. <ul style="list-style-type: none"> While in null mode, press  to view the relative value () that has been saved. The saved relative value will be displayed for 3 seconds. Press  while the relative value () is being displayed to cancel the Null function. 	<ul style="list-style-type: none">  enters the 1 ms Peak Hold mode. Press  to scroll through maximum () and minimum () peak readings. Press  for more than 1 second to exit this mode.

Table 1-2 Keypad descriptions and functions (continued)











































Button	Function when pressed for less than 1 second	Function when pressed for more than 1 second
4	  scrolls through the measurement function(s) of the present rotary switch selection.	<ul style="list-style-type: none"> -  enters the Setup mode. - In the Setup mode, press  or  to navigate through the menu pages. Press  or  to scroll through the available settings. - Press  to edit the specified value. - Press  again to save the new settings and exit the editing mode, or press  to exit without saving. - Press  for more than 1 second to exit this mode.
5	  scrolls through the available measurement ranges (except when the rotary switch is at the  or  position) ^[b] .	 enters the Auto Range mode.
6	  scrolls through the available dual-combination displays (except when the rotary switch is at the  ,  or  position, or when the multimeter is in 1 ms Peak Hold or Dynamic Recording mode) ^[c] .	 exits Hold, Null, Dynamic Recording, 1 ms Peak Hold, and dual display modes.

Table 1-2 Keypad descriptions and functions (continued)

Button	Function when pressed for less than 1 second	Function when pressed for more than 1 second
7	<p> -  enters the Frequency Test mode for current or voltage measurements.</p> <ul style="list-style-type: none"> - Press  to scroll through frequency (Hz), pulse width (ms), and duty cycle (%) functions. - In duty cycle (%) and pulse width (ms) tests, press  to switch between positive and negative edge trigger. - When the rotary switch is at the  position, and the Frequency Counter function is selected, pressing  will cycle through the frequency, pulse width, and duty cycle measurements. 	<ul style="list-style-type: none"> - If data logging is set as  (manual data logging), pressing  for more than 1 second will log the present reading into the memory. The display will return to normal after 3 seconds. To manually log another reading, press  again for more than 1 second. - If data logging is set as  (automatic data logging), pressing  for more than 1 second will enter the automatic data logging mode, and data is logged at the interval defined in Setup mode ^[a]. - Press  for more than 1 second to exit data logging mode.

Notes for keypad descriptions and functions:

- [a] See [Table 4-1](#) on page 111 for details of available options.
- [b] When the rotary switch is at  and the temperature measurement function is selected, pressing  will not affect any setting. When the rotary switch is at  and the frequency counter function is selected, press  to switch between dividing the signal frequency by 1 or 100.
- [c] When the rotary switch is at  and the temperature measurement function is selected, ETC (Environment Temperature Compensation) is ON by default. Press  to disable ETC;  will appear on the display. For pulse width and duty cycle measurements, press  to switch between positive and negative edge trigger. When the multimeter is in Peak or Dynamic Recording mode, press  to restart the 1 ms Peak Hold or Dynamic Recording mode.

The display at a glance

The display symbols are explained in the following tables.

Table 1-3 General display symbols













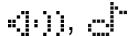



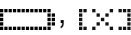

OLED Annunciator	Description
	Remote control
K, J	Type of thermocouple: K (K-type); J (J-type)
ΔNULL	Null math function
O'BASE	Relative value for Null mode
	Diode
	Audible continuity:  (SINGLE) or  (TONE) depending on Setup configuration
	View mode for checking logged data
	Data logging indication
A:1000, M:100, A:Full, A:Void	Index for logging data
	<ul style="list-style-type: none"> – Positive slope for pulse width (ms) and duty cycle (%) measurements – Capacitor is charging (during capacitance measurement)
	<ul style="list-style-type: none"> – Negative slope for pulse width (ms) and duty cycle (%) measurements – Capacitor is discharging (during capacitance measurement)
	Low battery indication (alternating between these two symbols)
	Auto Power-Off enabled
	Refresh (auto) Hold
	Trigger (manual) Hold

Table 1-3 General display symbols (continued)

OLED Annunciator	Description
	Dynamic Recording mode: Present value on primary display
	Dynamic Recording mode: Maximum value on primary display
	Dynamic Recording mode: Minimum value on primary display
	Dynamic Recording mode: Average value on primary display
	1 ms Peak Hold mode: Positive peak value on primary display
	1 ms Peak Hold mode: Negative peak value on primary display
	Hazardous voltage annunciator for measuring voltage ≥ 30 V or Overload

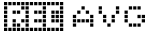
The primary display symbols are explained below.

Table 1-4 Primary display symbols











OLED annunciator	Description
AUTO	Auto range
	AC+DC
	DC
	AC
	Polarity, digits, and decimal points for primary display
dBm	Decibel unit relative to 1 mW
dBV	Decibel unit relative to 1 V
Hz, kHz, MHz	Frequency units: Hz, kHz, MHz
Ω , k Ω , M Ω	Resistance units: Ω , k Ω , M Ω
nS	Conductance unit: nS
mV, V	Voltage units: mV, V
μ A, mA, A	Current units: μ A, mA, A
nF, μ F, mF	Capacitance units: nF, μ F, mF
$^{\circ}$ C	Celsius temperature unit
$^{\circ}$ F	Fahrenheit temperature unit

Table 1-4 Primary display symbols (continued)

OLED annunciator	Description
	Duty cycle measurement
	Pulse width unit
	Percentage scale readout based on DC 0 mA to 20 mA
	Percentage scale readout based on DC 4 mA to 20 mA
	Reference impedance for the dBm unit
	Scale of bar graph

The secondary display annunciators are described below.

Table 1-5 Secondary display symbols





OLED Annunciator	Description
	AC+DC
	DC
	AC
-123.45	Polarity, digits, and decimal points for secondary display
dBm	Decibel unit relative to 1 mW
dBV	Decibel unit relative to 1 V
Hz, kHz, MHz	Frequency units: Hz, kHz, MHz
Ω, kΩ, MΩ	Resistance units: Ω , k Ω , M Ω
mV, V	Voltage units: mV, V
μA, mA, A	Current units: μ A, mA, A
nS	Conductance unit: nS
nF, μF, mF	Capacitance units: nF, μ F, mF
°C	Celsius ambient temperature unit
°F	Fahrenheit ambient temperature unit
	No ambient temperature compensation; just thermocouple measurement
ns	Pulse width unit
B:AS	Bias display

Table 1-5 Secondary display symbols (continued)

OLED Annunciator	Description
LEAK	Leak display
0000S	Elapsed time unit: s (second) for Dynamic Recording and 1 ms Peak Hold modes
	Hazardous voltage annunciator for measuring voltage ≥ 30 V or Overload



The analog bar emulates the needle on an analog multimeter, without displaying the overshoot. When measuring peak or null adjustments and viewing fast-changing inputs, the bar graph is useful because it provides a faster update rate to cater for fast-response applications.

For frequency, duty cycle, pulse width, 4 mA to 20 mA % scale, 0 mA to 20 mA % scale, dBm, dBV, and temperature measurements, the bar graph does not represent the primary display value.

- For example, when frequency, duty cycle, or pulse width is displayed on the primary display during voltage or current measurement, the bar graph represents the voltage or current value (not the frequency, duty cycle, or pulse width).
- When 4 mA to 20 mA % scale ($\frac{\%}{4-20}$) or 0 mA to 20 mA % scale ($\frac{\%}{0-20}$) is displayed on the primary display, the bar graph represents the current value and not the percentage value.

The “+” or “–” sign indicates whether the measured or calculated value is positive or negative. Each segment represents 2000 or 400 counts depending on the range indicated on the peak bar graph. See the following table.

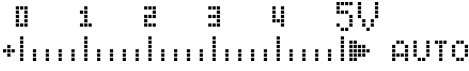
Table 1-6 Analog bar range and counts

Range	Counts/segments	Used for the function
	2000	V, A, Ω , nS, Diode
	400	V, A, Capacitance

Selecting display with the Shift button

The table below shows the primary display selection, with respect to measurement function (rotary switch position), using the Shift button.

Table 1-7 Selecting display with the Shift button









Rotary switch position (Function)	Primary display
 (AC voltage)	AC V
	dBm or dBV (in dual display mode) ^[a] _[b]
 (AC+DC voltage)	DC V
	AC V
 (AC+DC voltage)	AC+DC V
	DC mV
	AC mV
 (Resistance)	Ω
	Ω (Audible)
	nS
 (Diode Test & Frequency)	Diode
	Hz
 (Capacitance & Temperature)	Capacitance
	Temperature
 (AC+DC current)	DC μ A
	AC μ A
	AC+DC μ A

Table 1-7 Selecting display with the Shift button (continued)

Rotary switch position (Function)	Primary display
 (AC+DC current) (With the positive probe inserted into the $\mu\text{A}\cdot\text{mA}$ terminal)	DC mA
	AC mA
	AC+DC mA
	% (0 mA to 20 mA or 4 mA to 20 mA ^[a]) (Reading in mA or A is shown as secondary display)
 (AC+DC current) (With the positive probe inserted into the A terminal)	DC A
	AC A
	AC+DC A
	Duty cycle (%)
	Pulse width (ms)

Notes for selecting display with SHIFT button:

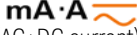
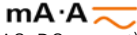
[a] Depends on the relevant setting in the Setup mode.

[b] Press  for more than 1 second to return to AC V measurement only.

Selecting display with the Dual button



- Press  to select different combinations of the dual display.
- Press and hold  for more than 1 second to return to normal single display.
- See the following table.

Table 1-8 Selecting display with the Dual button









Rotary switch position (Function)	Primary display	Secondary display
 (AC voltage)	AC V	Hz (AC coupling)
	dBm or dBV ^[a]	AC V
 (Default is DC voltage)	DC V	Hz (DC coupling)
	dBm or dBV ^[a]	DC V
	DC V	AC V
 (Press  to select AC voltage)	AC V	Hz (AC coupling)
	dBm or dBV ^[a]	AC V
	AC V	DC V
 (Press  twice to select AC+DC voltage)	AC+DC V	Hz (AC coupling)
	dBm or dBV ^[a]	AC+DC V
	AC+DC V	AC V
	AC+DC V	DC V
 (Default is DC voltage)	DC mV	Hz (DC coupling)
	dBm or dBV ^[a]	DC mV
	DC mV	AC mV
 (Press  to select AC voltage)	AC mV	Hz (AC coupling)
	dBm or dBV ^[a]	AC mV
	AC mV	DC mV

Table 1-8 Selecting display with the Dual button (continued)

















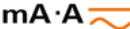

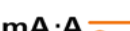

Rotary switch position (Function)	Primary display	Secondary display
 (Press  twice to select AC+DC voltage)	AC+DC mV	Hz (AC coupling)
	dBm or dBV ^[a]	AC+DC mV
	AC+DC mV	AC mV
	AC+DC mV	DC mV
 (Default is DC current)	DC µA	Hz (DC coupling)
	DC µA	AC µA
 (Press  to select AC current)	AC µA	Hz (AC coupling)
	AC µA	DC µA
 (Press  twice to select AC+DC current)	AC+DC µA	Hz (AC coupling)
	AC+DC µA	AC µA
	AC+DC µA	DC µA
 (Default is DC current)	DC mA	Hz (DC coupling)
	DC mA	AC mA
 (Press  to select AC current)	AC mA	Hz (AC coupling)
	AC mA	DC mA
 (Press  twice to select AC+DC current)	AC+DC mA	Hz (AC coupling)
	AC+DC mA	AC mA
	AC+DC mA	DC mA
 (Default is DC current)	DC A	Hz (DC coupling)
	DC A	AC A
 (Press  to select AC current)	AC A	Hz (AC coupling)
	AC A	DC A

Table 1-8 Selecting display with the Dual button (continued)

Rotary switch position (Function)	Primary display	Secondary display
 (Press  twice to select AC+DC current)	AC+DC A	Hz (AC coupling)
	AC+DC A	AC A
	AC+DC A	DC A
 (Capacitance)/  (Diode)/  (Conductance)	nF / V / nS	No secondary display. Ambient temperature in °C or °F is displayed in upper-right corner.
 (Resistance)	Ω	DC mV Bias, DC A Leak Ambient temperature in °C or °F is displayed in upper-right corner.
 (Temperature)	°C (°F)	If °C/°F or °F/°C dual-display is selected in the Setup, then the secondary display will indicate the temperature in the other unit (as opposed to the primary display). If single-unit display is selected in the Setup, there will be no secondary display. Ambient temperature in °C or °F is displayed in upper-right corner. Select 0 °C compensation by pressing  .

Notes for selecting display with DUAL button:

[a] Depends the relevant setting in Setup mode.

Selecting display with the Hz button

The frequency measurement function is able to detect the presence of harmonic currents in neutral conductors and determine whether these neutral currents are the result of unbalanced phases or non-linear loads.



- Press  to enter the Frequency measurement mode for current or voltage measurements – voltage or current on the secondary display, and frequency on the primary display.
- Alternatively, pulse width (ms) or duty cycle (%) can be displayed on the primary display by pressing  again. This allows simultaneous monitoring of real-time voltage or current with frequency, duty cycle, or pulse width.
- Hold  for more than 1 second to resume voltage or current reading on the primary display.

Table 1-9 Selecting display with the Hz button























Rotary switch position (Function)	Primary display	Secondary display
  (For  V, press  to select AC voltage)	Frequency (Hz)	
	Pulse width (ms)	AC V
	Duty cycle (%)	
 (Default is DC voltage)	Frequency (Hz)	
	Pulse width (ms)	DC V
	Duty cycle (%)	
 (Press  twice to select AC+DC voltage)	Frequency (Hz)	
	Pulse width (ms)	AC+DC V
	Duty cycle (%)	
 (Default is DC voltage)	Frequency (Hz)	
	Pulse width (ms)	DC mV
	Duty cycle (%)	
 (Press  to select AC voltage)	Frequency (Hz)	
	Pulse width (ms)	AC mV
	Duty cycle (%)	

Table 1-9 Selecting display with the Hz button (continued)

Rotary switch position (Function)	Primary display	Secondary display
 (Press  twice to select AC+DC voltage)	Frequency (Hz)	AC+DC mV
	Pulse width (ms)	
	Duty cycle (%)	
 (Default is DC current)	Frequency (Hz)	DC µA
	Pulse width (ms)	
	Duty cycle (%)	
 (Press  to select AC current)	Frequency (Hz)	AC µA
	Pulse width (ms)	
	Duty cycle (%)	
 (Press  twice to select AC+DC current)	Frequency (Hz)	AC+DC µA
	Pulse width (ms)	
	Duty cycle (%)	
 (Default is DC current)	Frequency (Hz)	DC mA or A
	Pulse width (ms)	
	Duty cycle (%)	
 (Press  to select AC current)	Frequency (Hz)	AC mA or A
	Pulse width (ms)	
	Duty cycle (%)	
 (Press  twice to select AC+DC current)	Frequency (Hz)	AC+DC mA
	Pulse width (ms)	
	Duty cycle (%)	
Hz (Frequency counter) (Only applicable for Divide-1 input)	Frequency (Hz)	Pulse width (ms)
	Pulse width (ms)	Frequency (Hz)
	Duty cycle (%)	

The terminals at a glance





















CAUTION

To avoid damaging the multimeter, do not exceed the rated input limit.

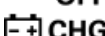

Figure 1-8 Connector terminals

Table 1-10 Terminal connections for different measurement functions

Rotary switch position	Input terminals	Overload protection
 V		1000 Vrms
 V		
 mV		
 nS  Ω	 ·  Ω · T V · mV	1000 Vrms for short circuit <0.3 A
 Hz 		
		
 μA   mA · A 	μA · mA	440 mA/1000 V, 30 kA fast-acting fuse
 mA · A 	A	11 A/1000 V, 30kA fast-acting fuse
 % OUT ms	 OUT	COM
OFF  CHG	 CHG	440 mA/1000 V fast-acting fuse

2 Making Measurements

Understanding The Measurement Instructions	52
Measuring Voltage	52
Measuring Current	57
Frequency Counter	62
Measuring Resistance, Conductance, and Testing Continuity	64
Testing Diodes	71
Measuring Capacitance	74
Measuring Temperature	76
Alerts and Warning During Measurement	80

This chapter contains information on how to make measurements using the U1253B true RMS OLED multimeter.

Understanding The Measurement Instructions



When making measurements, follow the numerical steps labelled in the diagrams. Refer to [Table 2-1](#) below for a description of the steps.

Table 2-1 Numerical steps descriptions

No.	Instructions
1	Turn the rotary switch to the measurement OPTION shown in the diagram
2	Connect the test leads into the input terminals shown in the diagram
3	Probe the test points
4	Read the results on the display

Measuring Voltage

The U1253B true RMS OLED multimeter returns an accurate RMS reading not only for sine waves, but also other AC signals such as square, triangle, and staircase waves.

For AC with DC offset, use AC+DC measurement by selecting  **V** or  **mV** with the rotary switch.

CAUTION

Ensure that terminal connections are correct for that particular measurement before making any measurement. To avoid damaging the multimeter, do not exceed the rated input limit.

Measuring AC voltage

Set up your multimeter to measure AC voltage as shown in [Figure 2-1](#). Probe the test points and read the display.

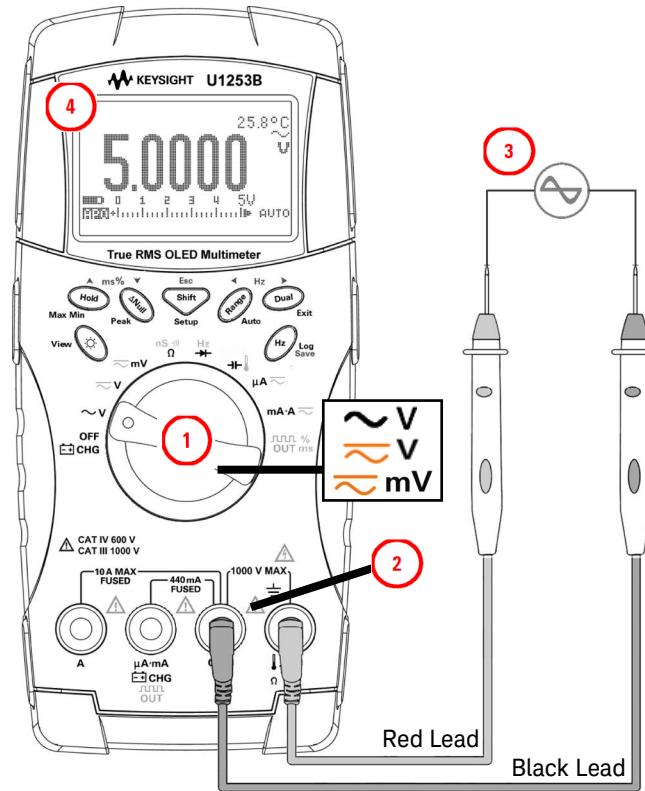





Figure 2-1 Measuring AC voltage





NOTE

- Press  if necessary to ensure  is shown on the display.
- Press  to display dual measurements. See [Table 1-8](#) of “[Selecting display with the Dual button](#)” on page 44 for a list of dual measurements available.
- Press and hold  for more than 1 second to exit dual display mode.

Measuring DC voltage

Set up your multimeter to measure DC voltage as shown in [Figure 2-2](#). Probe the test points and read the display.

NOTE

- Press  if necessary to ensure that  is shown on the display.
 - Press  to display dual measurements. See [Table 1-8](#) of “[Selecting display with the Dual button](#)” on page 44 for a list of dual measurements available.
 - Press and hold  for more than 1 second to exit dual display mode.
 - For firmware version 2.25 and below, the Filter function is switched off by default. You are strongly advised to update your products to the latest firmware version to take advantage of the latest features and measurement improvements.
 - For measuring DC voltage from a mixed signal in the DC measurement mode, ensure that the Filter is enabled (refer to “[Setting the Filter](#)” on page 144).
 - To avoid possible electric shock or personal injury, enable the Low Pass Filter to verify the presence of hazardous DC voltages. Displayed DC voltage values can be influenced by high frequency AC components and must be filtered to assure an accurate reading.
-

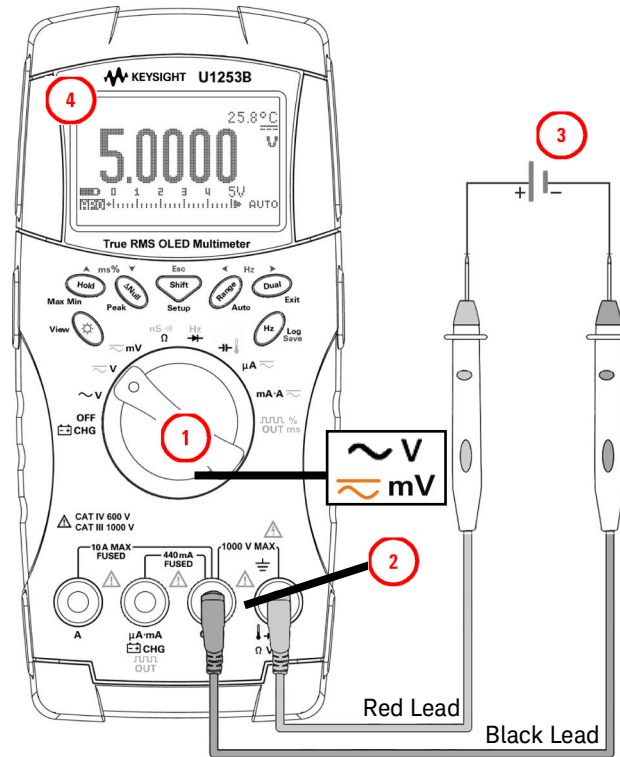

Figure 2-2 Measuring DC voltage

Measuring AC and DC Signals

Your multimeter is capable of displaying both AC and DC signal components, voltage or current, as two separate readings or one AC+DC (rms) value combined.

- 1 Set up your multimeter according to your desired measurement. Set the rotary switch to:



i For voltage measurements: \tilde{V} or \tilde{mV} .

ii For current measurements: \tilde{mA} or $\tilde{\mu A}$.

- 2 Press the  key twice to cycle the measurement function to the AC+DC mode (\tilde{V}). Probe the test points and read the display.

For better accuracy when measuring the DC offset of an AC voltage, measure the AC voltage first. Note the AC voltage range, then manually select a DC voltage range equal to or higher than the AC range. This procedure improves the accuracy of the DC measurement by ensuring that the input protection circuits are not activated.

NOTE







- Press  to cycle through the available dual display combinations.
- Press  to enable the frequency test mode for voltage measurements. See “[Frequency Counter](#)” on page 62 to learn more.

Measuring Current

μ A and mA measurement

Set up your multimeter to measure μ A and mA as shown in [Figure 2-3](#). Probe the test and read the display.

NOTE

- Press  to cycle between DC, AC, AC+DC, and % scale current measurements.
- For μ A measurement, set the rotary switch to μA , and connect the positive test lead to $\mu\text{A.mA}$.
- For mA measurement, set the rotary switch to $\text{mA}\cdot\text{A}$ , and connect the positive test lead to $\mu\text{A.mA}$.
- For A (ampere) measurement, set the rotary switch to $\text{mA}\cdot\text{A}$ , and connect the positive test lead to **A**.
- Press  to display dual measurements. See [Table 1-8](#) of “[Selecting display with the Dual button](#)” on page 44 for a list of dual measurements available.
- Press and hold  for more than 1 second to exit dual display mode.

CAUTION

- For measuring DC current from a mixed signal in the DC measurement mode, ensure that the Filter is enabled (refer to “[Setting the Filter](#)” on page 144).
- For measuring AC current signals with a DC offset, refer to “[Measuring AC and DC Signals](#)” on page 56.

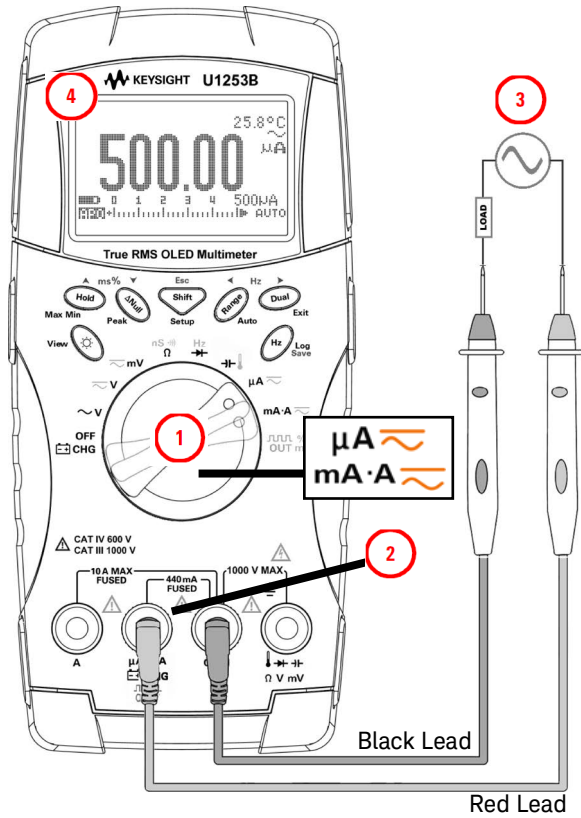





Figure 2-3 Measuring μA and mA current

Percentage scale of 4 mA to 20 mA

Set up the multimeter to measure percentage scale as shown in [Figure 2-4](#). Probe the test points and read the display.

NOTE

- Press  to select percentage scale display. Ensure that  or  is shown on the display.
- The percentage scale for 4 mA to 20 mA or 0 mA to 20 mA is calculated using its corresponding DC mA measurement. The U1253B will automatically optimize the best resolution according to [Table 2-2](#) below.
- Press  to change the measurement range.

The percentage scale for 4 mA to 20 mA or 0 mA to 20 mA is set to two ranges as follows:

Table 2-2 Percentage scale and measurement range

Percentage scale (4 mA to 20 or 0 mA to 20 mA) Always auto range	DC mA auto or manual range
999.99%	50 mA, 500 mA
9999.9%	

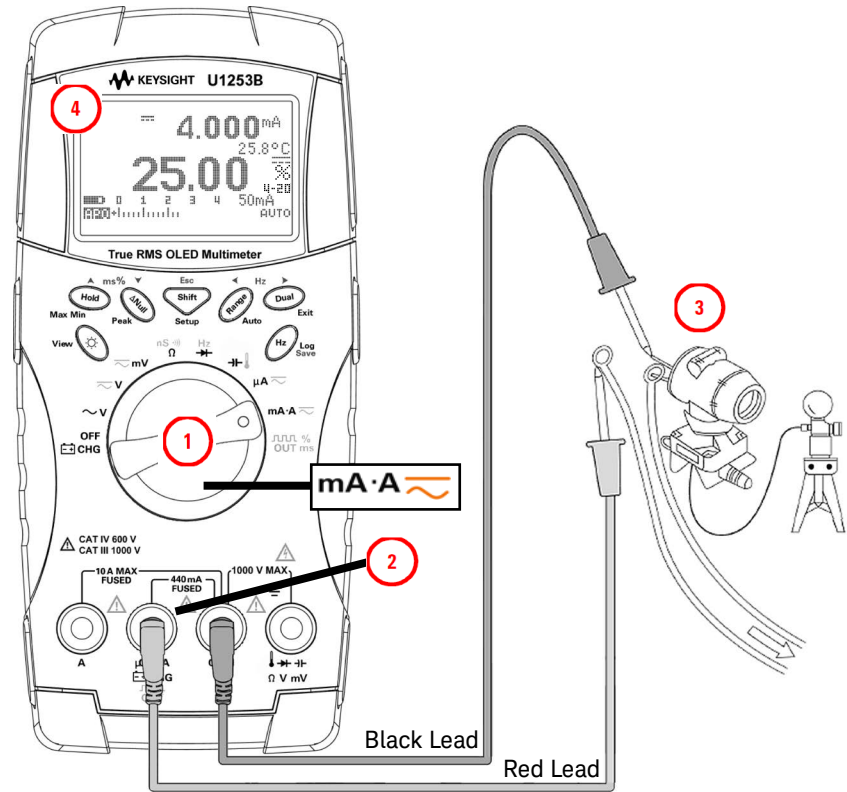



Figure 2-4 Measurement scale of 4 mA to 20 mA

A (ampere) measurement

Set up the multimeter to measure A (ampere) as shown in [Figure 2-5](#). Probe the test points and read the display.

NOTE

Connect the red and black test leads to 10 A input terminals **A (red)** and **COM (black)** respectively. The multimeter is set to  measurement automatically when the red test lead is plugged into the **A (red)** terminal.

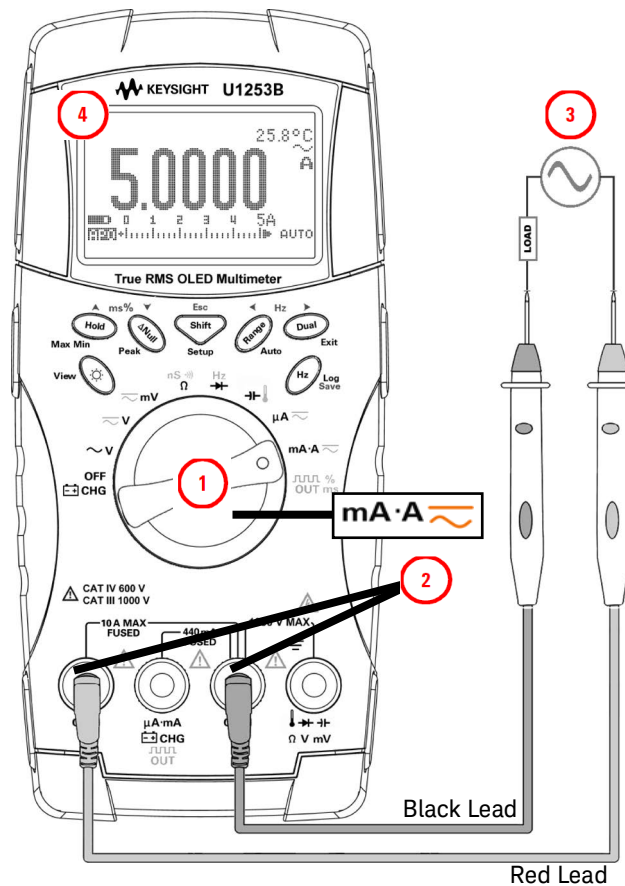

Figure 2-5 A (ampere) current measurement





Frequency Counter

WARNING

- Use the frequency counter only for low voltage applications. Never use the frequency counter on an AC power line system.
- For input more than 30 Vpp, you are required to use frequency measurement mode available under the current or voltage measurement instead of frequency counter.

Set up the multimeter to measure frequency as shown in [Figure 2-6](#). Probe the test points and read the display.

NOTE

- Press  to select the Frequency Counter () function. The default input signal frequency is divided by 1. This allows signals of up to a maximum frequency of 985 kHz to be measured.
- If the reading is unstable or zero, press  to select division of input signal frequency by 100 ( will be shown on the display). This allows for a higher frequency range of up to 20 MHz to be measured.
- The signal is out of range if the reading is still unstable after the above step has been performed.
- Press  to scroll through the pulse width (ms), duty cycle (%), and frequency (Hz) measurements.

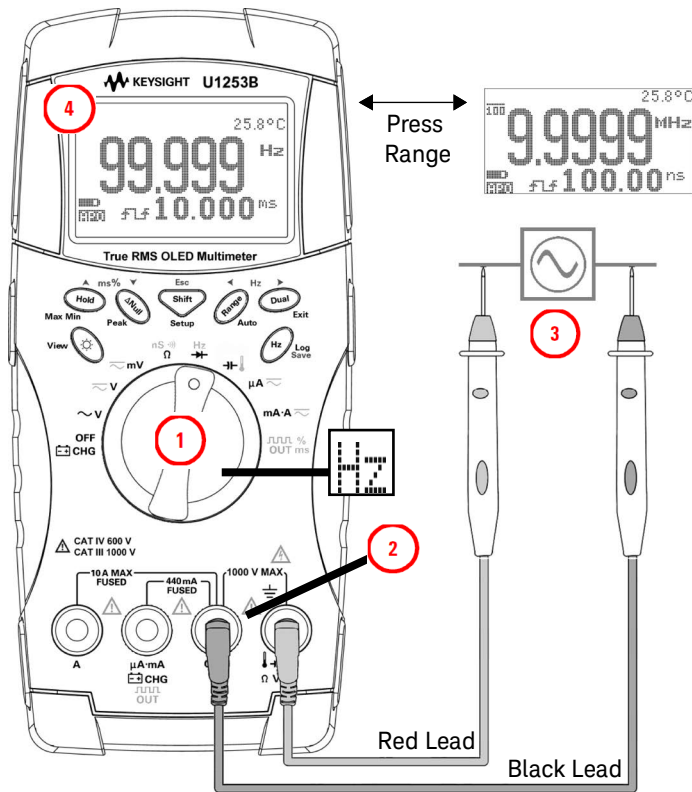

Figure 2-6 Measuring frequency



Measuring Resistance, Conductance, and Testing Continuity

CAUTION

Disconnect circuit power and discharge all high-voltage capacitors before measuring resistance or conductance, or testing circuit continuity, to avoid damaging the multimeter or the device under test.

Set up the multimeter to measure resistance as shown in [Figure 2-8](#). Then probe the test points (by shunting the resistor) and read the display.

NOTE

Press  to scroll through audible continuity test (🔊) or , depending on Setup configuration), conductance measurement (1/S), and resistance measurement (Ω, kΩ, or MΩ) as shown in [Figure 2-9](#) on page 67.

Smart Ω

Using the offset compensation method, Smart Ω removes unexpected DC voltages within instrument, at the input, or the circuit being measured, which will add error to resistance measurement. Besides, it also displays the bias voltage or leakage current (calculated based on bias voltage and corrected resistance value) on the secondary display. With offset compensation method, the multimeter takes the difference between two resistance measurements when two different test currents are applied to determine any offset voltage in the input circuitry. The resultant displayed measurement corrects this offset, giving a more accurate resistance measurement.

The Smart Ω is applicable for 500 Ω , 5 k Ω , 50 k Ω , and 500 k Ω resistance range only. The maximum correctable offset/bias voltage is ± 1.9 V for 500 Ω range and ± 0.35 V for 5 k Ω , 50 k Ω , and 500 k Ω range.

- Press **Dual** to enable Smart Ω feature. Press **Dual** again to cycle through Bias display or Leak display.
- Press **Dual** for more than one second to disable Smart Ω feature.

NOTE

The measurement time increases when Smart Ω is enabled.

Bias display

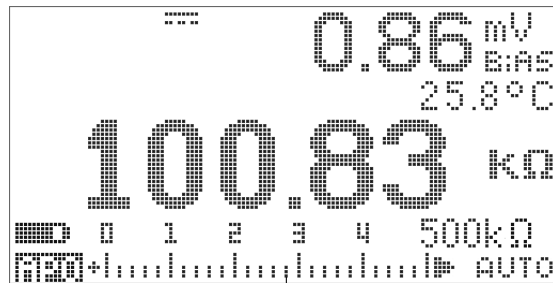

Leak display

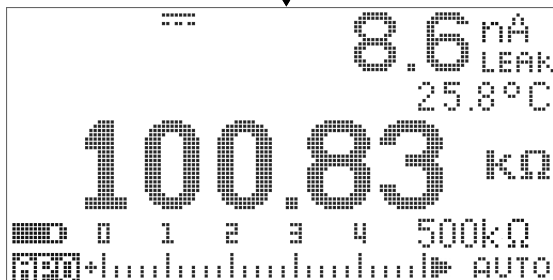

Press **Dual**

Press **Dual**

Figure 2-7 Type of display when Smart Ω is enabled

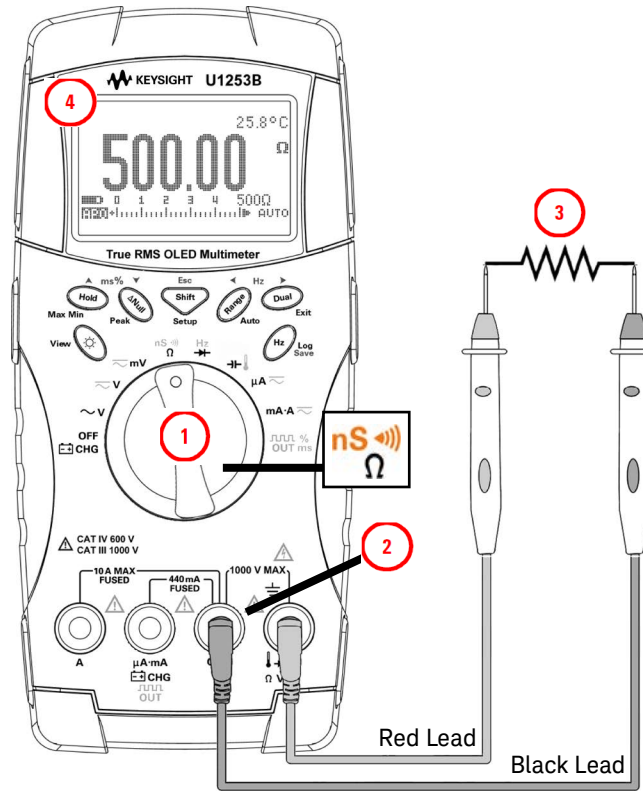

Figure 2-8 Measuring resistance

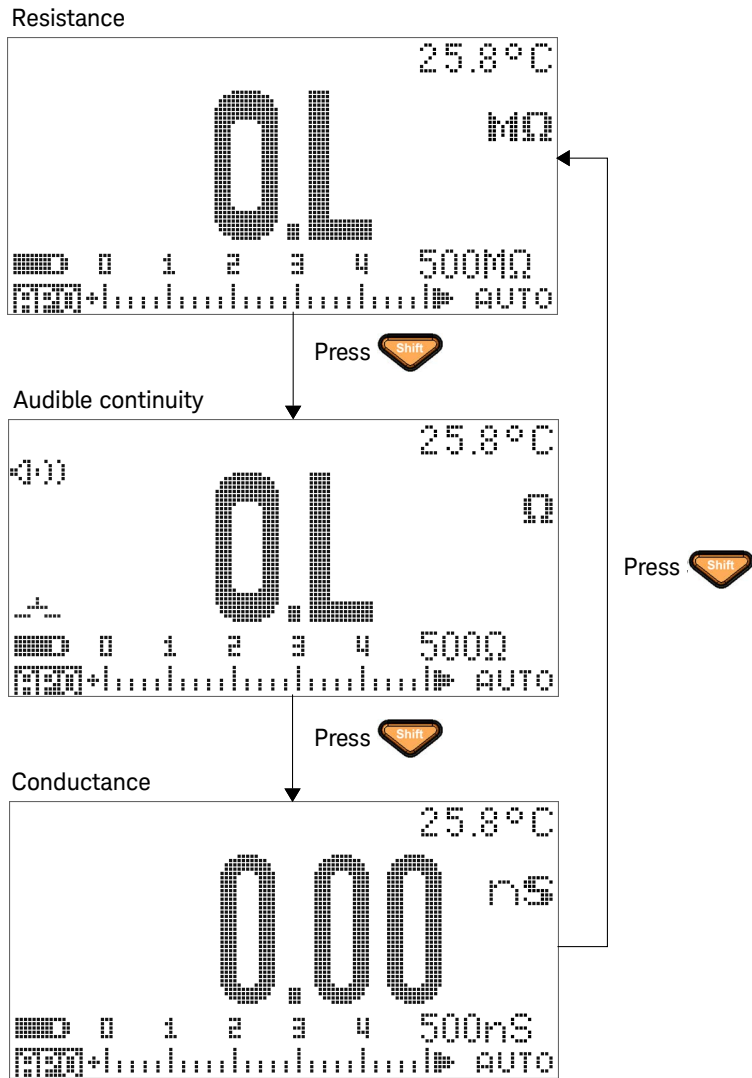

Figure 2-9 Resistance, audible continuity, and conductance tests

Audible continuity

In the range of 500 Ω range, the beeper will emit a sound if the resistance value falls below 10 Ω . For other ranges, the beeper will emit a sound if the resistance falls below the typical values listed in [Table 2-3](#) below.

Table 2-3 Audible continuity measurement range

Measurement range	Beeper sound threshold
500.00 Ω	< 10 Ω
5.0000 k Ω	< 100 Ω
50.000 k Ω	< 1 k Ω
500.00 k Ω	< 10 k Ω
5.0000 M Ω	< 100 k Ω
50.000 M Ω	< 1 M Ω
500.00 M Ω	< 10 M Ω

NOTE

When testing continuity, you can choose to test either short continuity or open continuity.

- By default, the multimeter is set to short continuity.
- Press  to select open continuity.

Short continuity

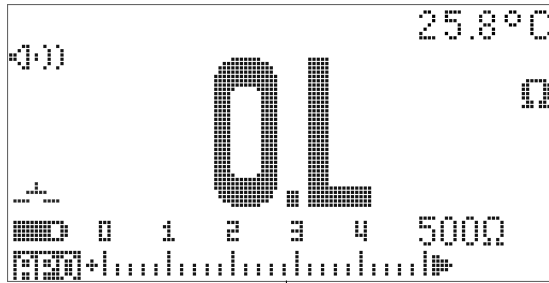

Press 

Open continuity

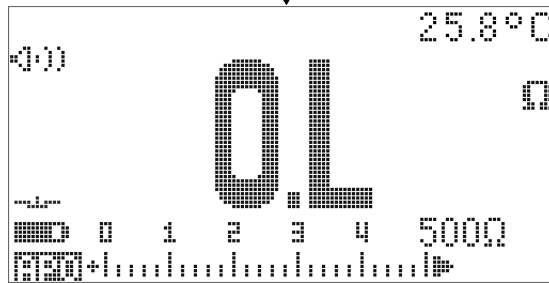

Press 

Figure 2-10 Short continuity and open continuity test

Conductance

Set up the multimeter to measure conductance as shown in [Figure 2-11](#). Probe the test points and read the display.

The conductance measurement function makes it easier to measure very high resistance of up to 100 GΩ. As high-resistance readings are susceptible to noise, you can capture average readings using the Dynamic Recording mode. Refer to the section [“Dynamic Recording”](#) on page 84 for more information.

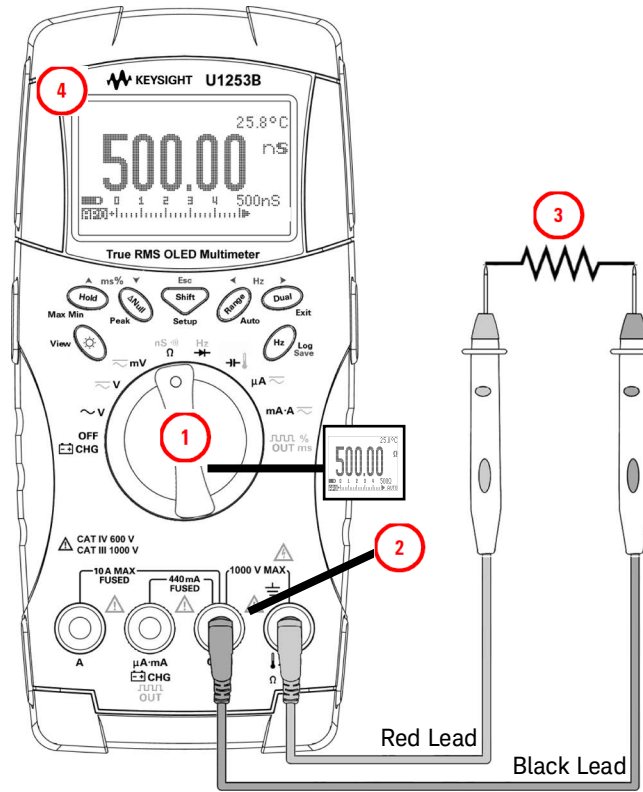

Figure 2-11 Conductance measurement

Testing Diodes

CAUTION

Disconnect circuit power and discharge all high-voltage capacitors before testing diodes to avoid damaging the multimeter.

To test a diode, turn the power off to the circuit and remove the diode from the circuit.

Set up the multimeter as shown in [Figure 2-12](#), then use the red probe lead on the positive terminal (anode) and use the black probe lead on the negative terminal (cathode) and read the display.

NOTE

- The cathode of a diode is indicated with a band.
 - This multimeter can display diode forward bias of up to approximately 3.1 V. The forward bias of a typical diode is within the range of 0.3 V to 0.8 V.
-

Next, reverse the probes and measure the voltage across the diode again (refer to [Figure 2-13](#) on page 73). The diode's test result is based on the following:

- A diode is considered good if the multimeter displays "**OL**" in reverse bias mode.
- A diode is considered shorted if the multimeter displays approximately 0 V in both forward and reverse bias modes, and the multimeter beeps continuously.
- A diode is considered open if the multimeter displays "**OL**" in both forward and reverse bias modes.

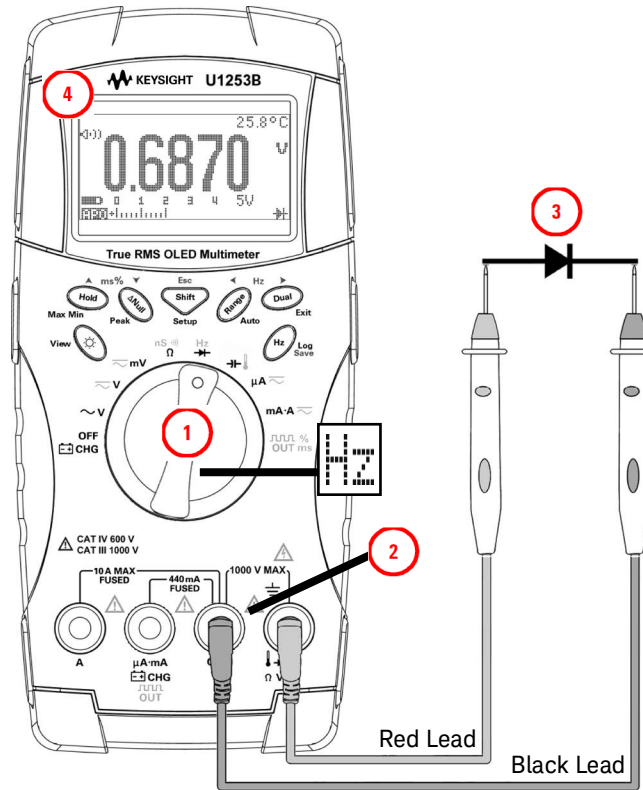

Figure 2-12 Measuring the forward bias of a diode

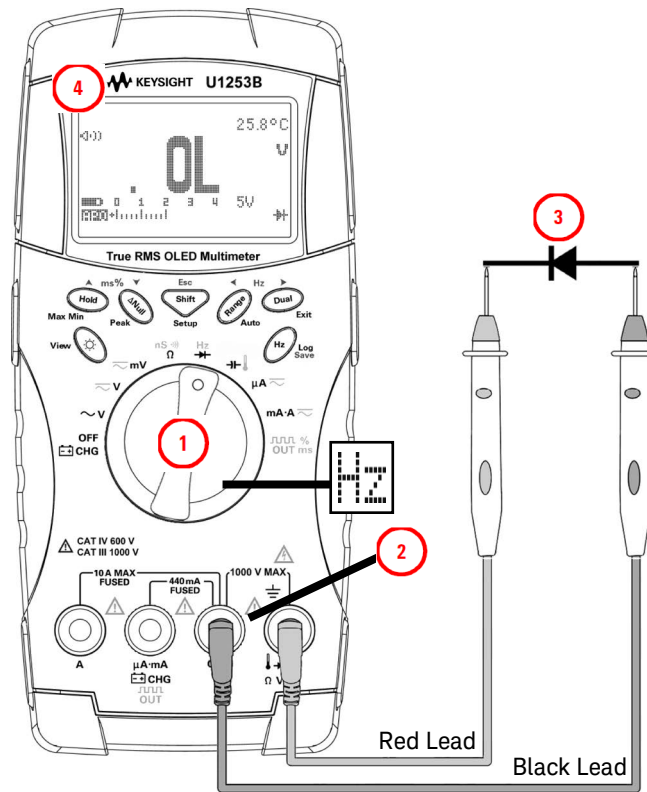

Figure 2-13 Measuring the reverse bias of a diode

Measuring Capacitance

CAUTION



Disconnect circuit power and discharge all high-voltage capacitors before measuring capacitance to avoid damaging the multimeter or the device under test. Use the DC voltage function in order to confirm that a capacitor has fully discharged.

The U1253B true RMS OLED multimeter calculates capacitance by charging a capacitor with a known current for a period of time, measuring the voltage and then calculating the capacitance. The larger the capacitor, the longer the charge time. Below are some tips for measuring capacitance:

Measuring tips:

- For measuring capacitance values greater than 10,000 μF , discharge the capacitor first, then select a suitable range for measurement. This will speed up the measurement time and also ensure that the correct capacitance value is obtained.
- For measuring small capacitance values, press  with the test leads open to subtract the residual capacitance of the multimeter and leads.

NOTE

 means that the capacitor is charging.  means that the capacitor is discharging.

Set up the multimeter as shown in [Figure 2-14](#). Use the red test lead on the positive terminal of the capacitor and the black test lead on the negative terminal and read the display.

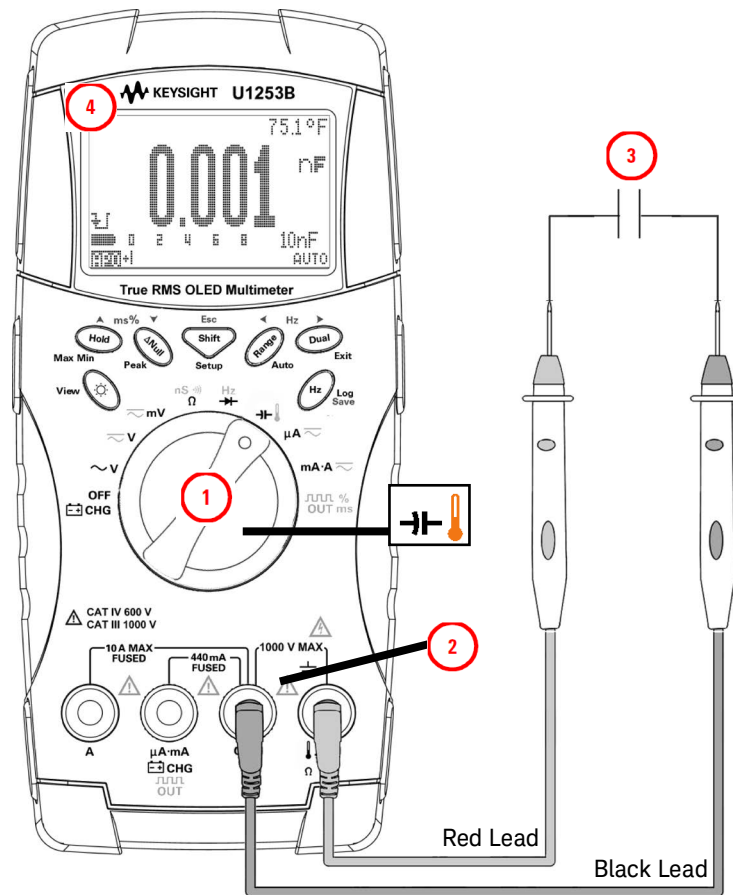

Figure 2-14 Capacitance measurements

Measuring Temperature

CAUTION

Do not bend the thermocouple leads at sharp angles. Repeated bending over a period of time can result in the leads breaking.

The bead-type thermocouple probe is suitable for measuring temperatures from $-20\text{ }^{\circ}\text{C}$ to $200\text{ }^{\circ}\text{C}$ in PTFE-compatible environments. Do not use the thermocouple probe beyond the recommended operating range. Do not immerse this thermocouple probe in any liquid. Use a thermocouple probe designed for each specific application – an immersion probe for liquid or gel, and an air probe for air measurement.

Set up the multimeter to measure temperature as shown in [Figure 2-17](#) or observe the following steps:

- 1 Press  to select temperature measurement.
- 2 Connect the miniature thermal probe into the non-compensation transfer adapter as shown in [Figure 2-15](#). Then connect the thermal probe with the adapter into the meter input terminals as shown in [Figure 2-16](#).
- 3 For best performance, place the meter in the operating environment for at least one hour to stabilize the unit to environment temperatures.
- 4 Clean the surface to be measured and ensure that the probe is securely touching the surface. Remember to disable the applied power.
- 5 When measuring above ambient temperatures, move the thermocouple along the surface until you get the highest temperature reading.
- 6 When measuring below ambient temperatures, move the thermocouple along the surface until you get the lowest temperature reading.
- 7 For quick measurement, use the $0\text{ }^{\circ}\text{C}$ compensation to view the temperature variation of the thermocouple sensor. The $0\text{ }^{\circ}\text{C}$ compensation assists you in measuring relative temperature immediately.

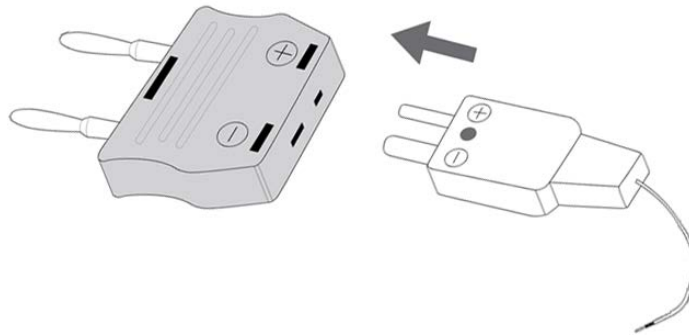

Figure 2-15 Connecting the thermal probe into the non-compensation transfer adapter

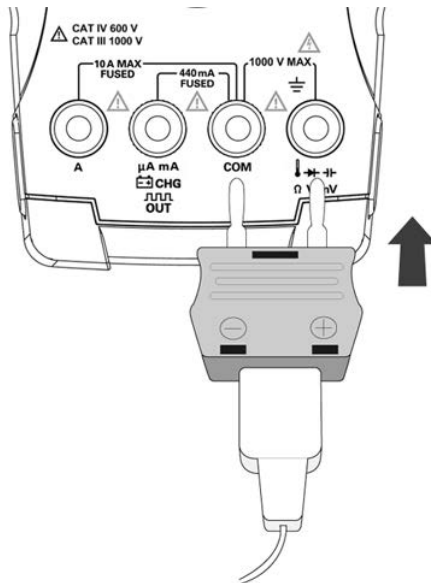



Figure 2-16 Connecting the probe with adapter into the multimeter

2 Making Measurements

If you are working in a constantly varying environment, where ambient temperatures are not constant, do the following:

- 1 Press  to select 0 °C compensation. This allows a quick measurement of the relative temperature.
- 2 Avoid contact between the thermocouple probe and the surface to be measured.
- 3 After a constant reading is obtained, press  to set the reading as the relative reference temperature.
- 4 Touch the surface to be measured with the thermocouple probe.
- 5 Read the display for the relative temperature.

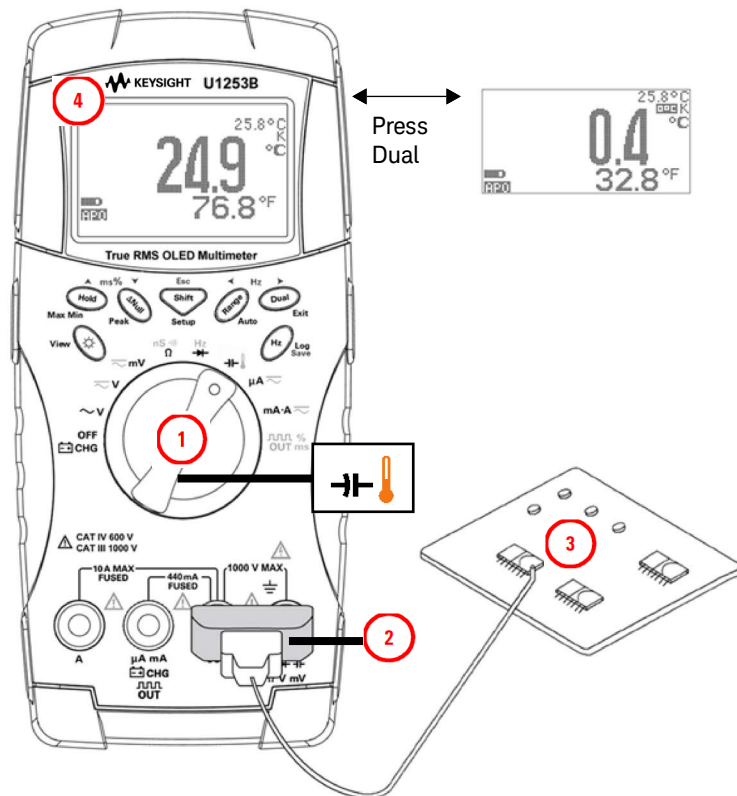

Figure 2-17 Surface temperature measurement

Alerts and Warning During Measurement

Overload alert

WARNING

For your own safety, look out for this alert. When you see this alert, immediately remove the test leads from the measuring source.

This multimeter provides an overload alert for voltage measurement in both auto and manual range modes. The multimeter starts beeping periodically once the measured voltage exceeds the **V-ALERT** value set in the Setup mode. Immediately remove the test leads from the source being measured.

By default, this feature is turned off. Be sure to set the alerting voltage according to your requirement.

The multimeter will also display  as an early warning for hazardous voltage when the measured voltage is equal to or greater than 30 V in all three DC V, AC V, and AC+DC V measurement modes.

For a manually selected measurement range, when the measured value is outside the range, the display will indicate **OL**.

Input warning

The multimeter emits a continuous beep when the test lead is inserted to the **A** input terminal but the rotary switch is not set to the corresponding **mA.A** position. A warning message **Error ON A INPUT** will be displayed until the test lead is removed from the **A** input terminal. Refer to [Figure 2-18](#).

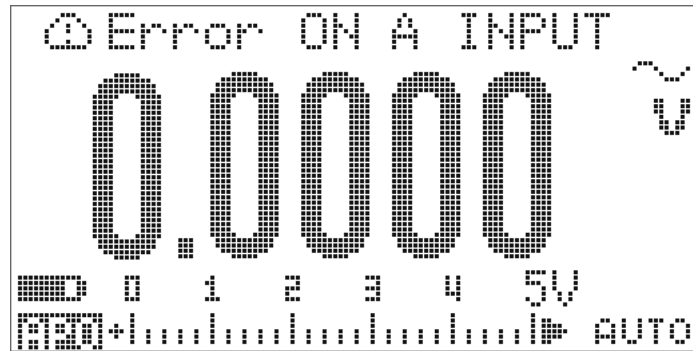

Figure 2-18 Input terminal warning

Charge terminal alert

The multimeter emits a continuous beep when the **CHG** terminal detects a voltage level of more than 5 V and the rotary switch is not set to the corresponding **OFF** **CHG** position. A warning message **Error ON mA INPUT** will be displayed until the lead is removed from the **CHG** input terminal.

Refer to [Figure 2-19](#) below.

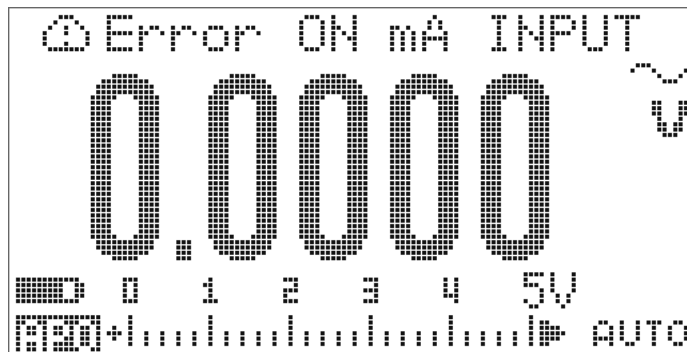

Figure 2-19 Charge terminal alert

3 Functions and Features









Dynamic Recording	84
Data Hold (Trigger Hold)	86
Refresh Hold	88
Null (Relative)	90
Decibel Display	92
1 ms Peak Hold	95
Data Logging	97
Square Wave Output	103
Remote Communication	107

This chapter contains information on the functions and features available for the U1253B true RMS OLED multimeter.



Dynamic Recording

The Dynamic Recording mode can be used to detect intermittent turn-on or turn-off voltage, current surges or to verify measurement performance without you being present during the process. While the readings are being recorded, you are free to perform other tasks.

The average reading is useful for smoothing out unstable inputs, estimating the percentage of time a circuit is operating and verifying circuit performance. The elapsed time is shown on the secondary display. The maximum time is 99,999 seconds. When this maximum time is exceeded, “**OL**” is shown on the display.

- 1 Press  for more than 1 second to enter the Dynamic Recording mode. The multimeter is now in continuous mode or non-data hold (non-trigger) mode.  and the present measurement value is displayed. The multimeter emits a sound when a new maximum or minimum value is recorded.
- 2 Press  to cycle through maximum (), minimum (), average (), and present readings ().
- 3 Press  or  for more than 1 second to exit Dynamic Recording mode.

NOTE

- Press  to restart dynamic recording.
- The average value is the true average of all measured values taken in the Dynamic recording mode. If an overload is recorded, the averaging function will stop and the average value becomes “**OL**” (overload). Auto Power Off  is disabled in Dynamic Recording mode.

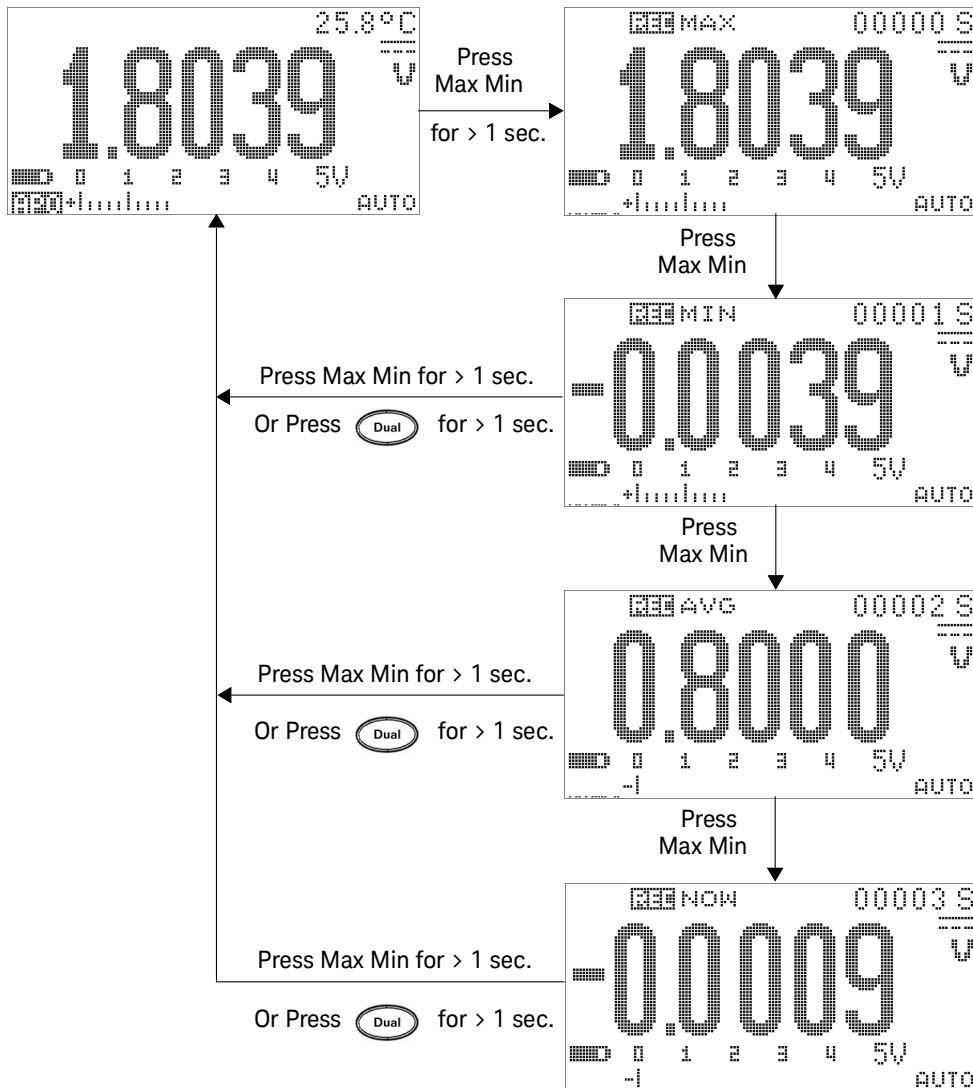



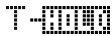





Figure 3-1 Dynamic recording mode operation

Data Hold (Trigger Hold)

The Data Hold function allows you to freeze the displayed value.

- 1 Press  to freeze the displayed value and to enter manual trigger mode.  is displayed.
- 2 Press  again to freeze the next value being measured. The character “T” in the  annunciator flashes before the new value is updated on the display.
- 3 While in the Data Hold mode, you may press  to switch between DC, AC, and AC+DC measurements.
- 4 Press and hold  or  for more than 1 second to quit the data hold function.

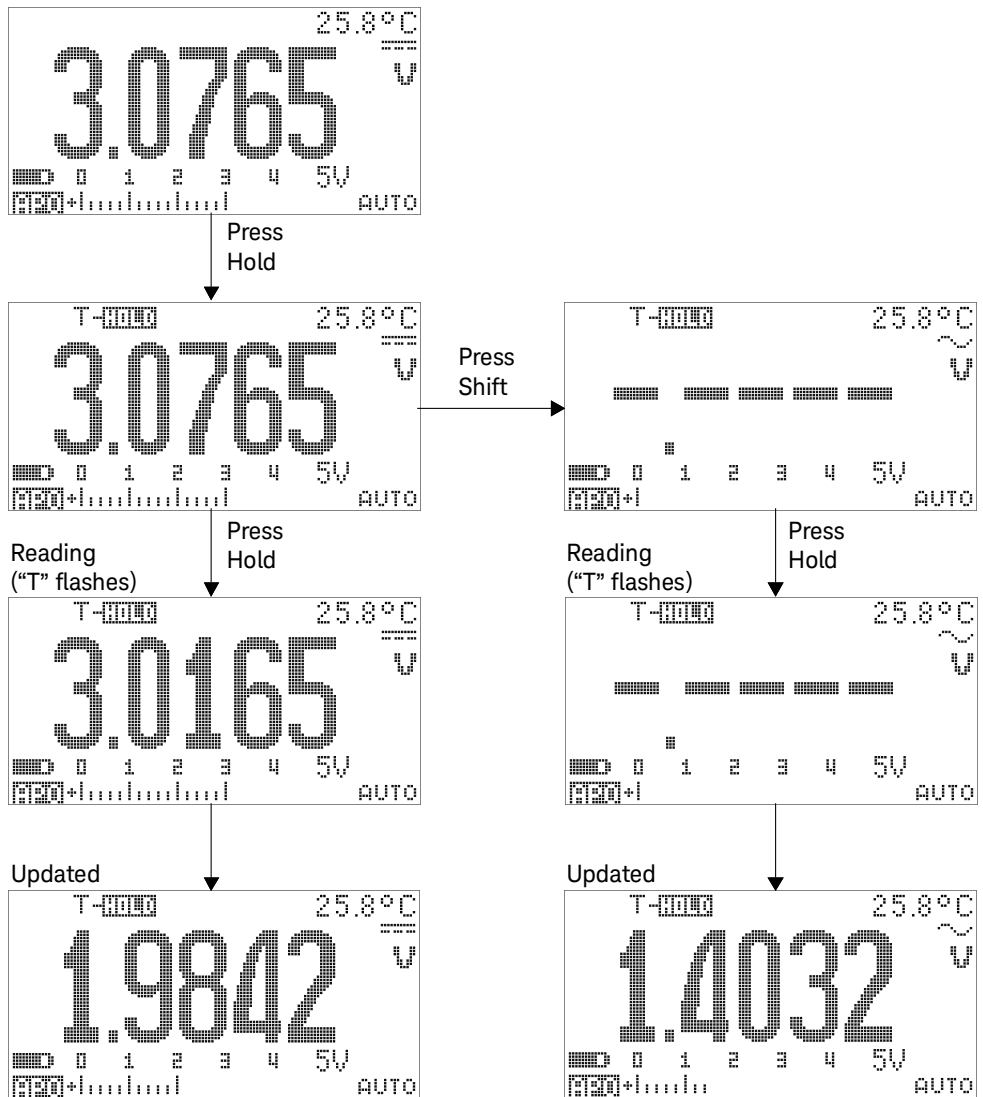









Figure 3-2 Data hold mode operation

Refresh Hold

The Refresh Hold function allows you to freeze the displayed value. The bar-graph is not held and will continue to reflect the instantaneous measured value. You can use the Setup mode to enable Refresh Hold mode when you are working with fluctuating values. This function will auto trigger or update the held value with a new measured value and emit a tone as a reminder.

- 1 Press  to enter Refresh Hold mode. The present value will be held and the  symbol will appear.
- 2 It will be ready to hold a new measured value once the variation of measured values exceeds the variation count setting. While the multimeter is waiting for a new stable value, the character “R” in the  annunciator will flash.
- 3 The  annunciator will stop flashing once the new measured value is stable and the new value will be updated to the display. The  annunciator will remain on and the multimeter will emit a tone to remind you of this.
- 4 Press  again to disable this function. You may also press  for more than 1 second to quit the Refresh Hold function.

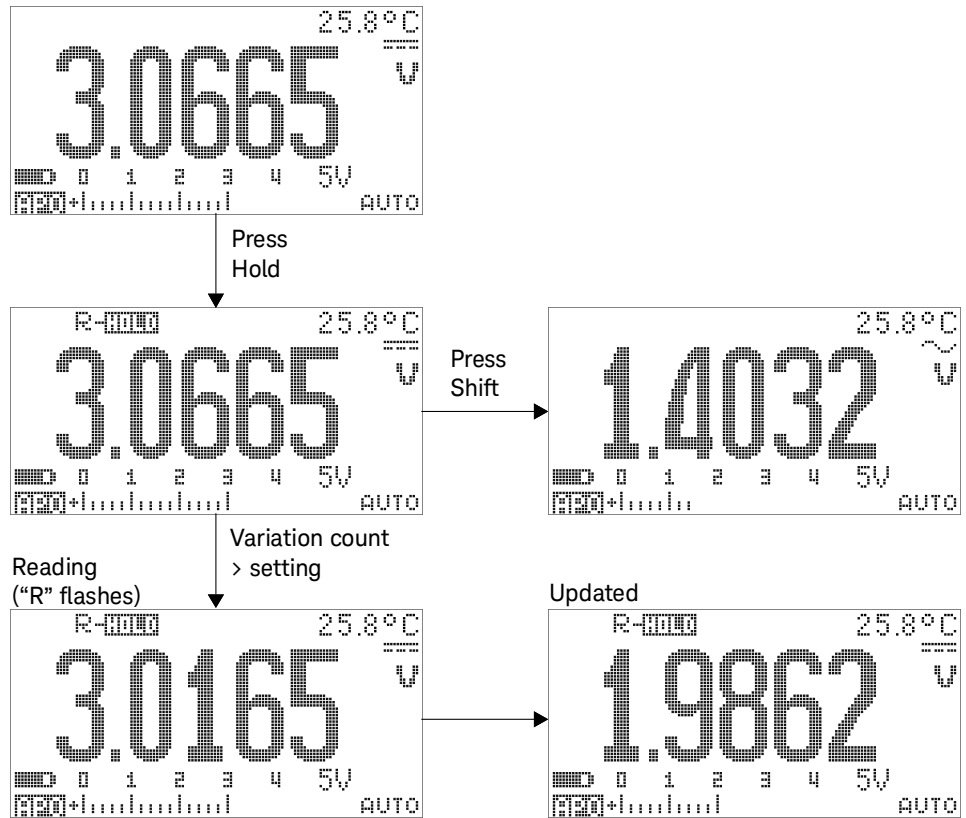



Figure 3-3 Refresh hold mode operation

NOTE

- For voltage and current measurements, the held value will not be updated if the reading is below 500 counts.
- For resistance and diode measurements, the held value will not be updated if the reading is "OL" (open state).
- For all types of measurement, the held value will not be updated until the reading has reached a stable state.



Null (Relative)

The Null function subtracts a stored value from the present measurement and displays the difference between the two.

- 1 Press  to store the displayed reading as the reference value to be subtracted from subsequent measurements and to set the display to zero. Δ NULL is displayed.

NOTE

Null can be set for both auto and manual range settings, but not in the case of an overload.

- 2 Press  to view the stored reference value. O'BASE and the stored reference value are displayed for 3 seconds.
- 3 Press  within the 3 seconds when O'BASE and the stored reference value is displayed to exit this mode.

NOTE

- In resistance measurement mode, the multimeter will read a non-zero value even when the two test leads are in direct contact, because of the resistance of these leads. Use the Null function to zero-adjust the display.
- In DC voltage measurement mode, thermal effects will influence the accuracy. Short the test leads and press  once the displayed value is stable to zero-adjust the display.

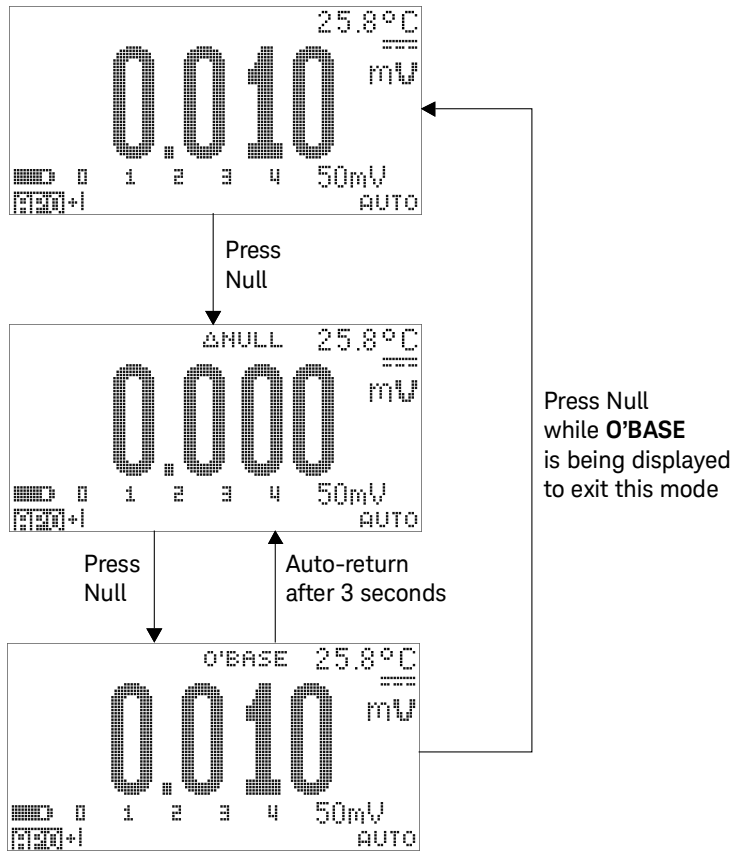

Figure 3-4 Null (relative) mode operation

Decibel Display





The dBm unit calculates the power delivered to a reference resistance relative to 1 mW and can be applied to DC V, AC V and AC+DC V measurements for decibel conversion. Voltage measurement is converted to dBm using the following formula:

$$dBm = 10\log\left(\frac{1000 \times (\textit{measured voltage})^2}{\textit{reference impedance}}\right) \quad (1)$$

The reference impedance may be specified from 1 Ω to 9999 Ω in Setup mode. The default value is 50 Ω .

The dBV unit calculates the voltage with respect to 1 V. The formula is as shown below:

$$dBV = 20\log(\textit{measured voltage}) \quad (2)$$

- 1 With the rotary switch set at , , or , press  to navigate to dBm or dBV^[1] measurement on the primary display. The voltage measurement is indicated on the secondary display.
- 2 Press  for more than 1 second to exit this mode.

[1] Depends on configuration in Setup mode.

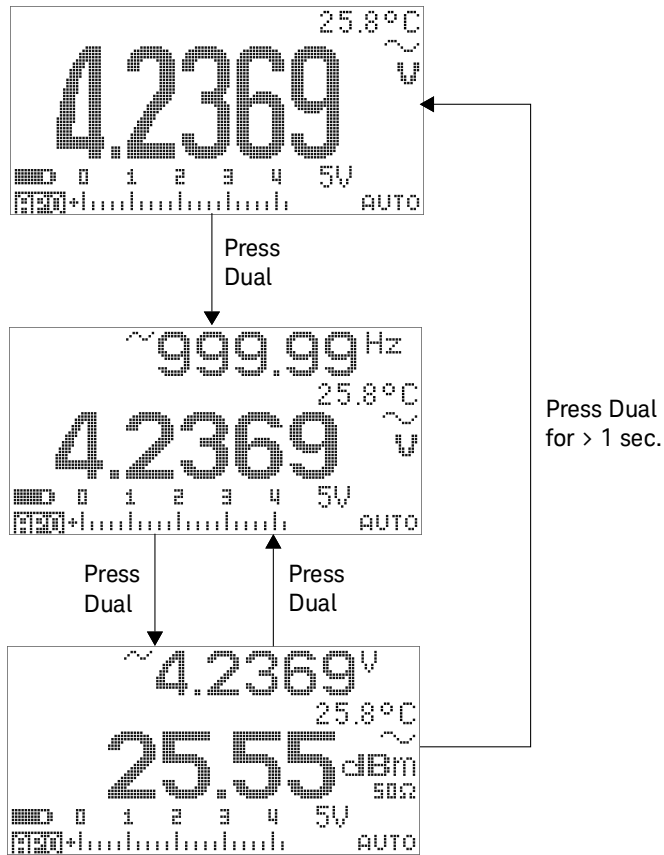

Figure 3-5 dBm display mode operation

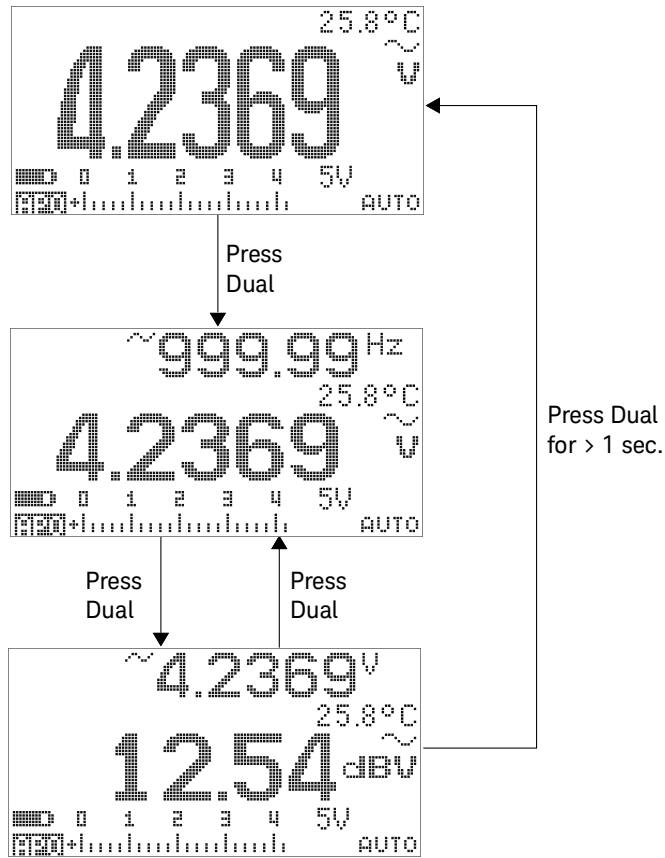



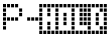

Figure 3-6 dBV display mode operation



1 ms Peak Hold



The Peak Hold function allows the measurement of peak voltage for analysis of components such as power distribution transformers and power factor correction capacitors. The peak voltage obtained can be used to determine the crest factor:

$$\text{Crest factor} = \frac{\text{Peak value}}{\text{True RMS value}} \quad (3)$$

- 1 Press  for more than 1 second to toggle 1 ms Peak Hold mode ON and OFF.
- 2 Press  to switch between maximum and minimum peak readings.
 indicates maximum peak, while  indicates minimum peak.

NOTE

- If the reading is “OL”, press  to change the measurement range and to restart peak-recording measurement.
- If you need to restart peak recording without changing the range, press .

- 3 Press and hold  or  for more than 1 second to exit this mode.
- 4 In the measurement example shown in [Figure 3-7](#) on page 96, the crest factor will be $2.2669/1.6032 = 1.414$.

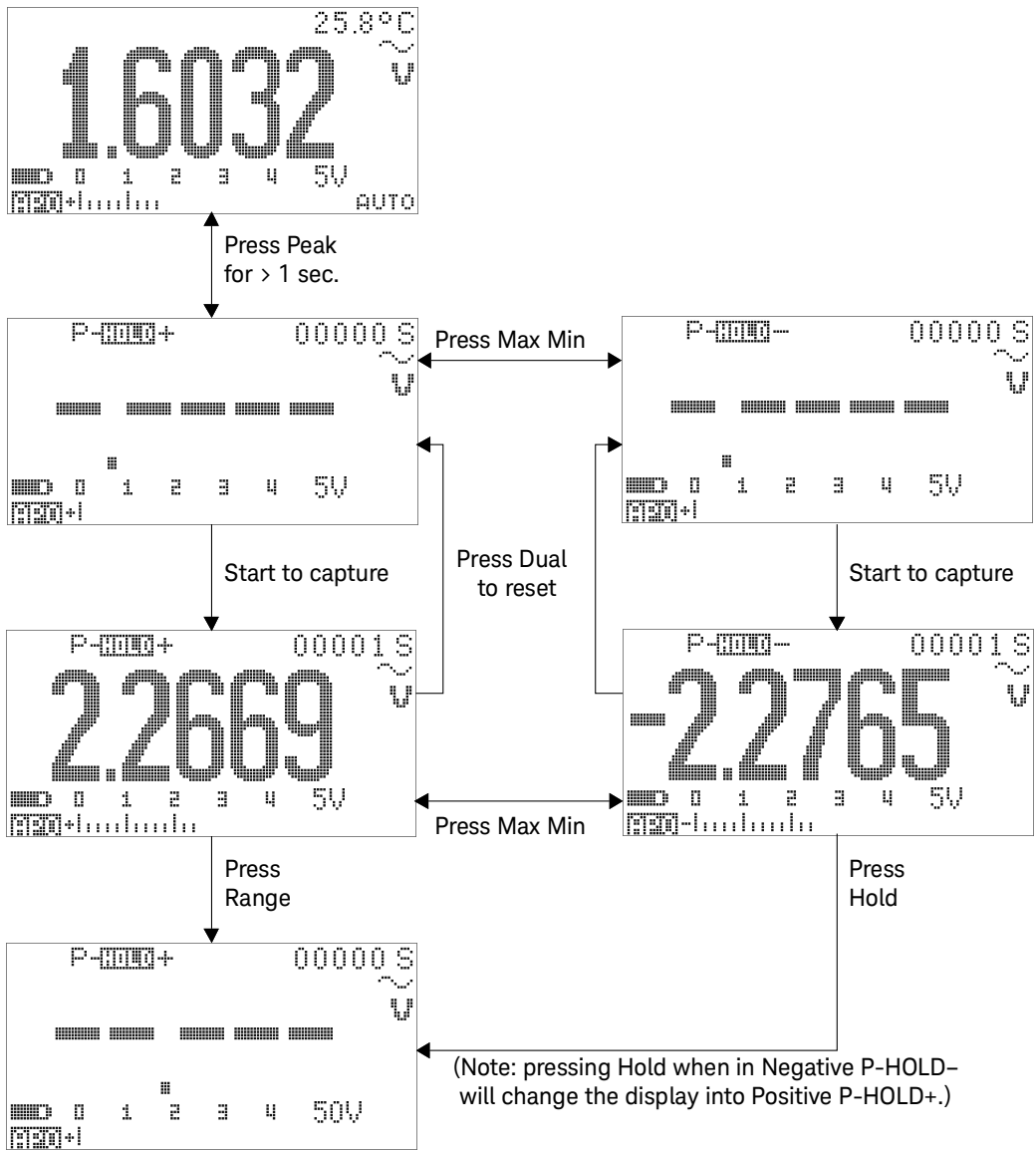

Figure 3-7 1 ms peak hold mode operation

Data Logging



The data logging function provides the convenience of recording test data for future review or analysis. Since data is stored in nonvolatile memory, the data remains saved when the multimeter is turned OFF or the battery is changed.

The two options offered are manual (hand) logging and interval (time) logging functions, which is determined in the Setup mode.

Data logging records the values on the primary display only.

Manual logging

Firstly, ensure that manual (hand) logging is specified in Setup mode.

- 1 Press  for more than 1 second to store the present value and function on the primary display to the non-volatile memory. The  and the logging index will be displayed for 3 seconds.
- 2 Press and hold  again for the next value that you would like to save into the memory.

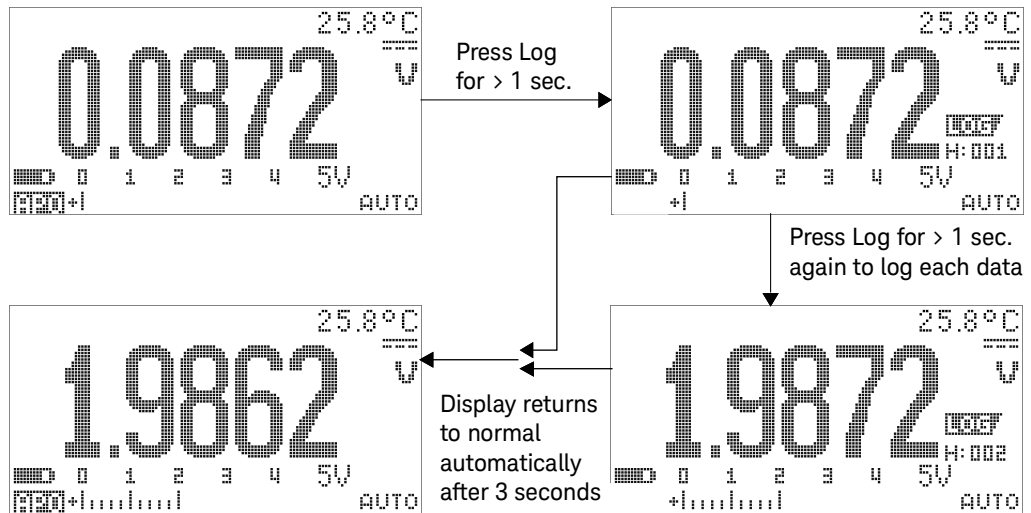

Figure 3-8 Manual (hand) logging mode operation

NOTE

The maximum number of readings that can be stored is 100 entries. When the 100 entries are all occupied, the logging index will indicate “Full”, as shown in [Figure 3-9](#).

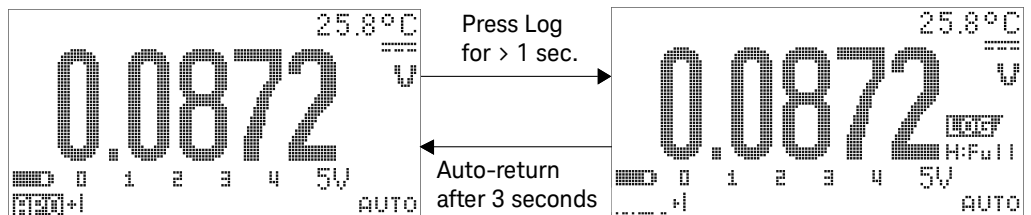



Figure 3-9 Full log

Interval logging

Firstly ensure that interval (time) logging is specified in Setup mode.

- 1 Press  for more than 1 second to store the present value and function on the primary display into the non-volatile memory. The  and the logging index will be indicated. Subsequent readings are automatically logged into the memory at the interval (LOG TIME) specified in Setup mode. Refer to [Figure 3-10](#) on page 100 for how to operate this mode.

NOTE

The maximum number of readings that can be stored is 1000 entries. When the 1000 entries are all occupied, the logging index will indicate “Full”.

- 2 Press  for more than 1 second to exit this mode.

NOTE

When interval (time) logging is running, all keypad operations are disabled, except for **Log**, which, when pressed for longer than 1 second, will exit this mode. Furthermore, Auto Power Off is disabled during interval logging.

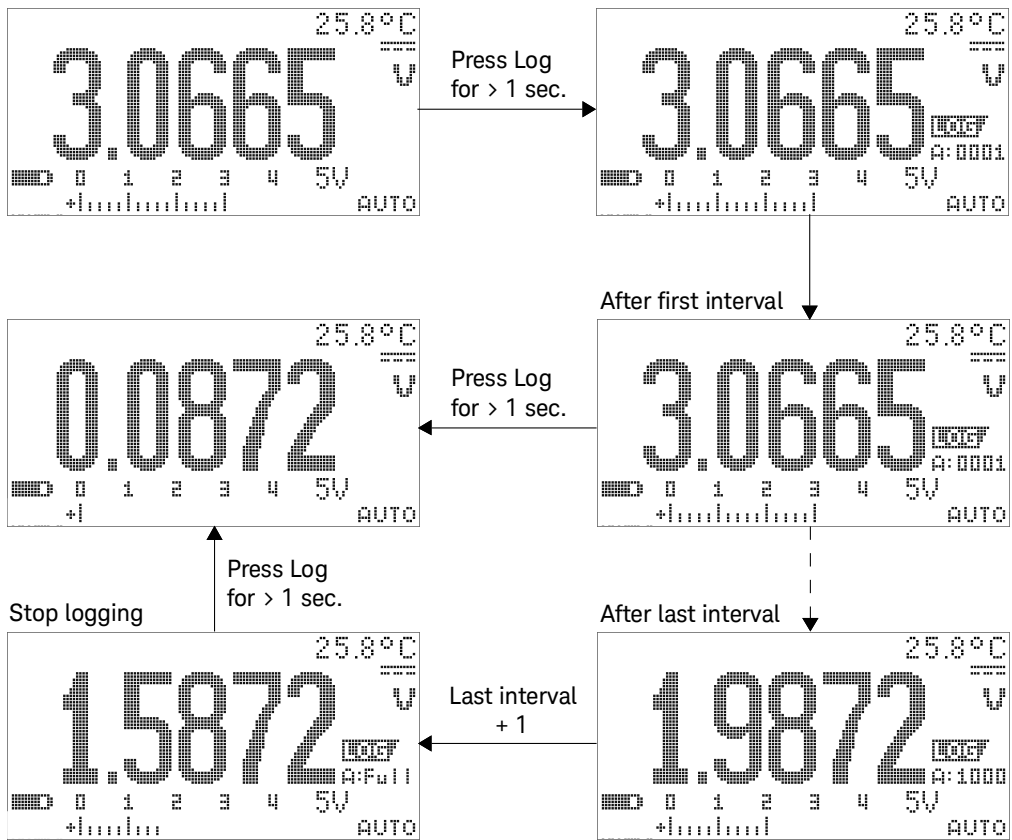











Figure 3-10 Interval (time) logging mode operation

Reviewing logged data

- 1 Press  for more than 1 second to enter Log Review mode. The last logged entry, , and the last logging index are displayed.
- 2 Press  to switch between manual (hand) and interval (time) logging review mode.
- 3 Press  to ascend or  to descend through the logged data. Press  to select first record and  to select the last record for quick navigation.
- 4 Press  for more than 1 second at the respective Log Review mode to clear logged data.
- 5 Press  for more than 1 second to stop logging and exit this mode.

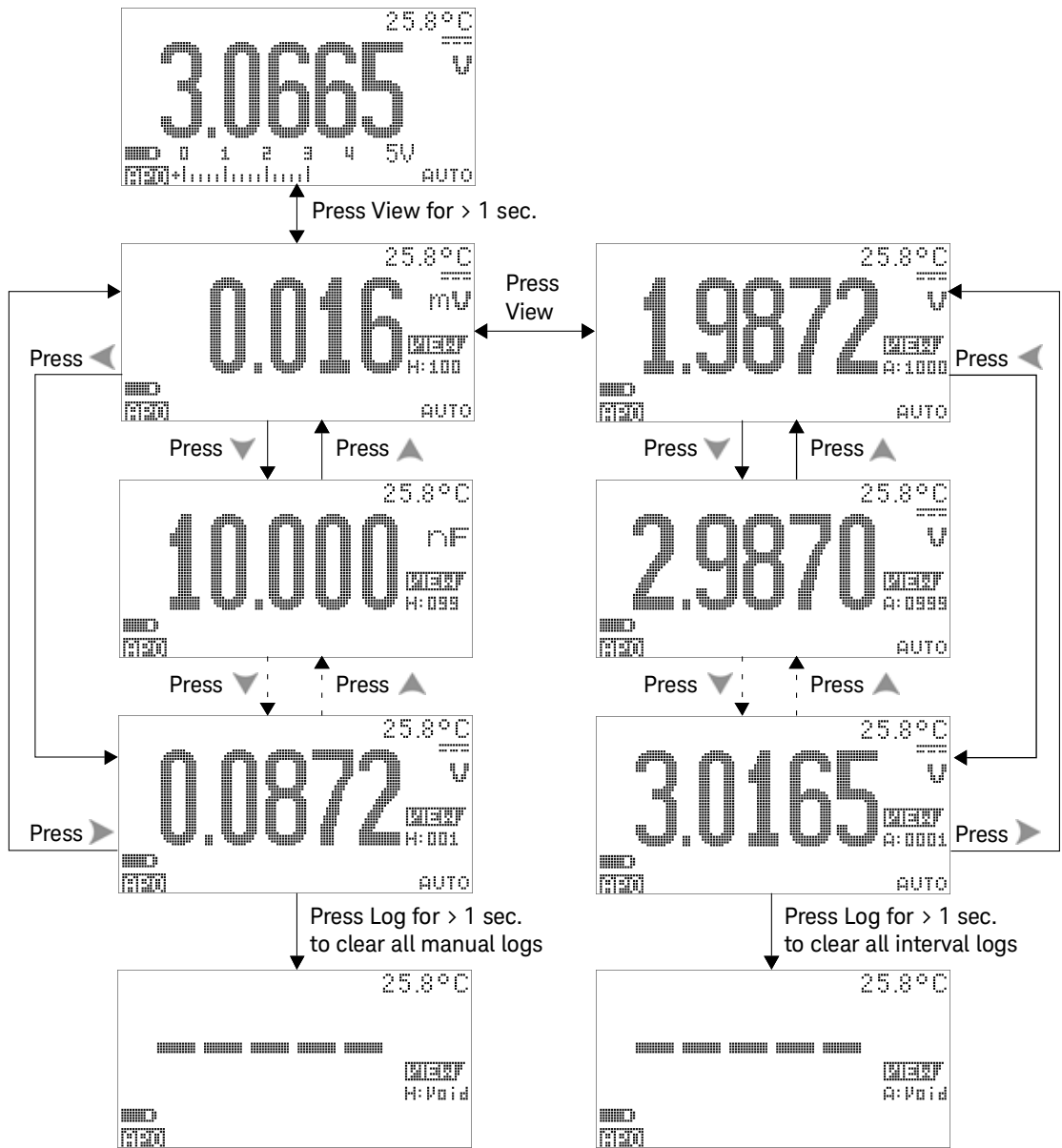

Figure 3-11 Log review mode operation

Square Wave Output

The U1253B true RMS OLED multimeter’s square wave output can be used to generate a PWM (pulse width modulation) output or provide a synchronous clock source (baud rate generator). You can also use this function to check and calibrate flow-meter displays, counters, tachometers, oscilloscopes, frequency converters, frequency transmitters, and other frequency input devices.

Selecting square wave output frequency





- 1 Set the rotary switch to  **OUT ms**. The default pulse width is 0.8333 ms and default frequency is 600 Hz, as shown on the primary and secondary displays respectively.
- 2 Press  to switch between duty cycle and pulse width for the primary display.
- 3 Press  or  to scroll through the available frequencies (there are 29 frequencies to choose from).

Table 3-1 Available frequencies for square wave output

Frequency (Hz)
0.5, 1, 2, 5, 6, 10, 15, 20, 25, 30, 40, 50, 60, 75, 80, 100, 120, 150, 200, 240, 300, 400, 480, 600, 800, 1200, 1600, 2400, 4800

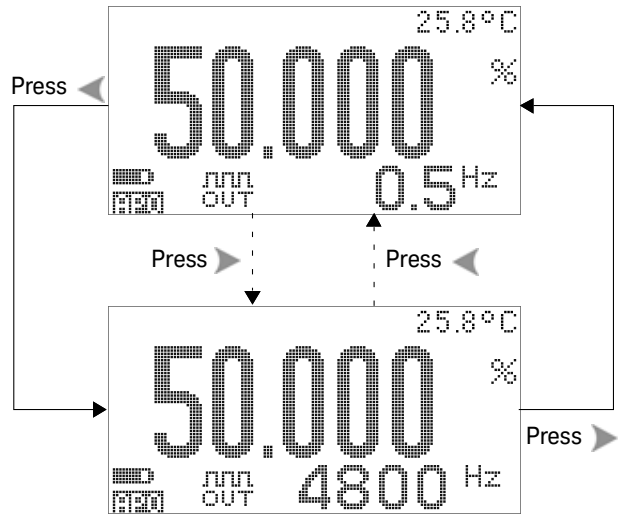





Figure 3-12 Frequency adjustment for square wave output

Selecting square wave output duty cycle

- 1 Set the rotary switch to  **OUT ms.**
- 2 Press  to select duty cycle (%) on the primary display.
- 3 Press  or  to adjust the duty cycle. The duty cycle can be stepped through 256 steps, with each step equivalent to 0.390625%. The best resolution the display can offer is 0.001%.

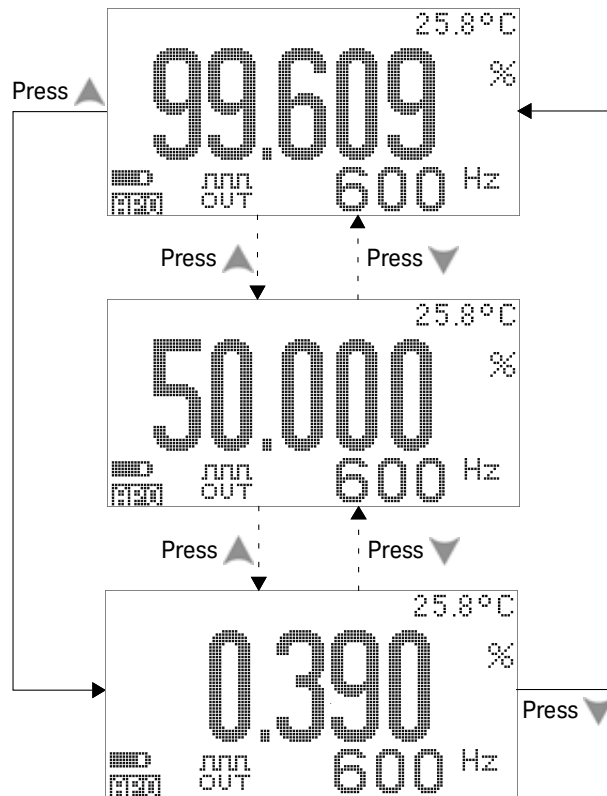

Figure 3-13 Duty cycle adjustment for square wave output

Selecting square wave output pulse width

- 1 Set the rotary switch to **OUT ms.**
- 2 Press **Shift** to select pulse width (ms) on the primary display.
- 3 Press **▲** or **▼** to adjust the pulse width. The pulse width can be stepped through 256 steps, with each step equivalent to $1/(256 \times \text{frequency})$. The displayed pulse width will be automatically adjusted to 5 digits (ranging from 9.9999 to 9999.9 ms).

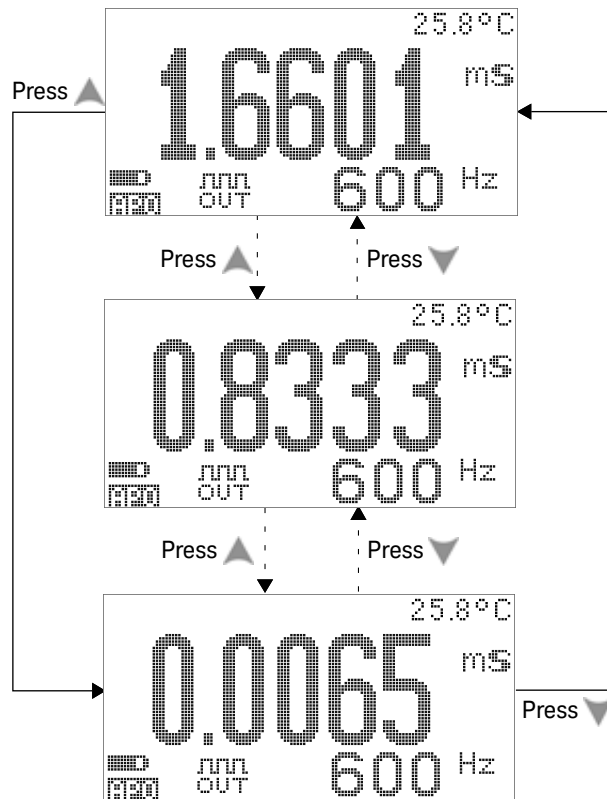

Figure 3-14 Pulse width adjustment for square wave output

Remote Communication

This multimeter has a bidirectional (full duplex) communication capability that enables data transfer from the multimeter to a PC. The required accessory for this is an optional IR-USB cable, to be used with an application software that is downloadable from the Keysight website.

For details on performing PC to meter remote communication click on Help after launching the Keysight GUI Data Logger Software or refer to the [GUI Data Logger Quick Start Guide](#) (U1251-90003) for more information.

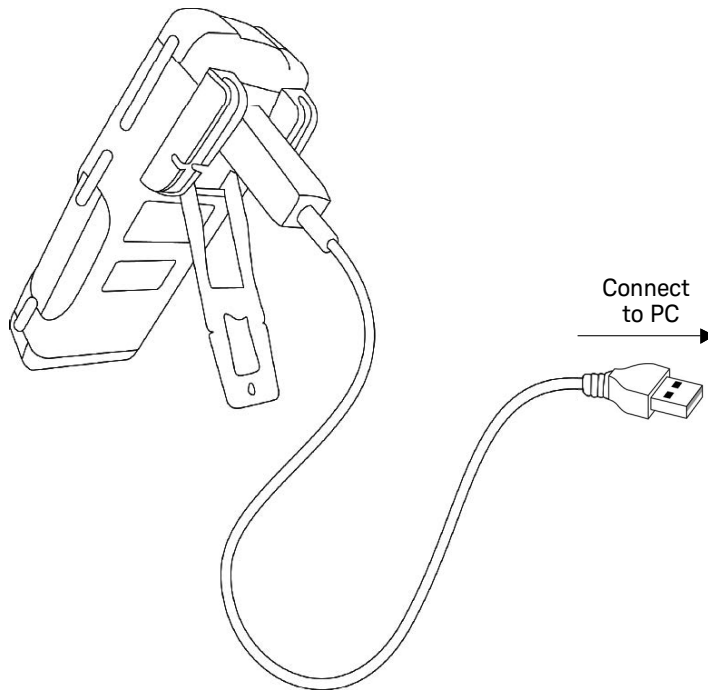

Figure 3-15 Cable connection for remote communication

THIS PAGE HAS BEEN INTENTIONALLY LEFT BLANK.

4 Changing the Default Settings













Selecting Setup Mode	110
Default Factory Settings and Available Setting Options	111

This chapter will show you how to change the default factory settings of the U1253B true RMS OLED multimeter and other available setting options.

Selecting Setup Mode

To enter Setup mode, press and hold  for more than 1 second.

To change a menu item setting in Setup mode, perform the following steps:

- 1 Press  or  to view the selected menu pages.
- 2 Press  or  to navigate to the item that needs to be changed.
- 3 Press  to enter the **EDIT** mode for adjusting the item you want to change.
When you are in the **EDIT** mode:
 - i Press  or  to select which digit to adjust.
 - ii Press  or  to adjust the value.
 - iii Press  to exit **EDIT** mode without saving the changes.
 - iv Press  to save the changes you have made and exit the **EDIT** mode.
- 4 Press  for more than 1 second to exit Setup mode.

Default Factory Settings and Available Setting Options

The following table shows the various menu items with their respective default settings and available options.

Table 4-1 Default factory settings and available setting options for each feature

Menu	Feature	Default factory setting	Available setting options
1	RHOLD	500	Refresh hold. <ul style="list-style-type: none"> - To enable this function, select a value within the range of 100 to 9900. - To disable this function, set all digits to zero ("OFF" will be indicated). Note: Select OFF to enable data hold (manual trigger).
	D-LOG	HAND	Available options for data logging: <ul style="list-style-type: none"> - HAND: manual data logging. - TIME: interval (automatic) data logging, where the interval is according to the LOG TIME setting.
	LOG TIME	0001 S	Logging interval for interval (time) data logging. Select a value within the range of 0001 second to 9999 seconds.
	dB	dBm	<ul style="list-style-type: none"> - Available options: dBm, dBV, or OFF. - Select OFF to disable this function for normal operation.
	dBm-R	50 Ω	Reference impedance value for dBm measurement. Select a value within the range of 1 Ω to 9999 Ω .

Table 4-1 Default factory settings and available setting options for each feature (continued)



Menu	Feature	Default factory setting	Available setting options
2	T-TYPE	K	Thermocouple type. – Available options: K-type or J-type
	T-UNIT	°C	Temperature unit. – Available options: – °C/°F: Dual display, °C in primary display, °F in secondary. – °C: Single display, in °C only. – °F/°C: Dual display, °F in primary display, °C in secondary. – °F: Single display, in °F only. – Press  to swap between °C and °F.
	mA-SCALE	4 mA to 20 mA	Percentage scale for mA. – Available options: 4 – 20 mA, 0 – 20 mA, or OFF. – Select OFF to disable this function for normal operation.
	CONTINUITY	SINGLE	Audible continuity. – Available options: SINGLE, OFF, or TONE.
	MIN-Hz	0.5 Hz	Minimum measurement frequency. Available options: 0.5 Hz, 1 Hz, 2 Hz, or 5 Hz.
	BEEP	2400	Beep frequency. – Available options: 4800 Hz, 2400 Hz, 1200 Hz, 600 Hz, or OFF. – To disable this function, select OFF.
3	APO	10 M	Automatic power off. – To enable this function, select a value within the range of 1 minute to 99 minutes. – To disable this function, set all digits to zero (“OFF” will be indicated).
	BACKLIT	HIGH	Default power-on backlight brightness level. Available options: HIGH, MEDIUM, or LOW.
	MELODY	FACTORY	Power-on melody. Available options: FACTORY, USER, or OFF.
	GREETING	FACTORY	Power-on greeting. Available options: FACTORY, USER, or OFF.

Table 4-1 Default factory settings and available setting options for each feature (continued)

Menu	Feature	Default factory setting	Available setting options
4	BAUD	9600	Baud rate for remote communication with a PC (remote control). Available options: 2400, 4800, 9600, and 19200.
	DATA BIT	8	Data bit length for remote communication with a PC. Available options: 8 bits or 7 bits (stop bit is always 1 bit).
	PARITY	NONE	Parity bit for remote communication with a PC. Available options: NONE, ODD, or EVEN.
	ECHO	OFF	Return of characters to PC in remote communication. Available options: ON or OFF.
	PRINT	OFF	Prints measured data to a PC in remote communication. Available options: ON or OFF.
5	REVISION	NN.NN	Revision number. Editing is disabled.
	S/N	NNNNNNNN	The last 8 digits of the serial number will be indicated. Editing is disabled.
	V-ALERT	OFF	Audible alert tone for voltage measurement. <ul style="list-style-type: none"> – To enable this function, select an overvoltage value within the range of 1 V to 1010 V. – To disable this function, set all digits to zero ("OFF" will be indicated).
	M-INITIAL	FACTORY	Initial measurement functions. Available options: FACTORY or USER.
	SMOOTH	NORMAL	Refresh rate for primary display readings. Available options: FAST, NORMAL, or SLOW.
6	DEFAULT	NO	Select YES, then press  for longer than 1 second to reset the multimeter to its default factory settings.
	BATTERY	7.2 V	Battery type used for the multimeter. Available options: 7.2 V or 8.4 V.
	DC FILTER	OFF	Filter for DC voltage or DC current measurement. Available options: OFF or ON.

4 Changing the Default Settings

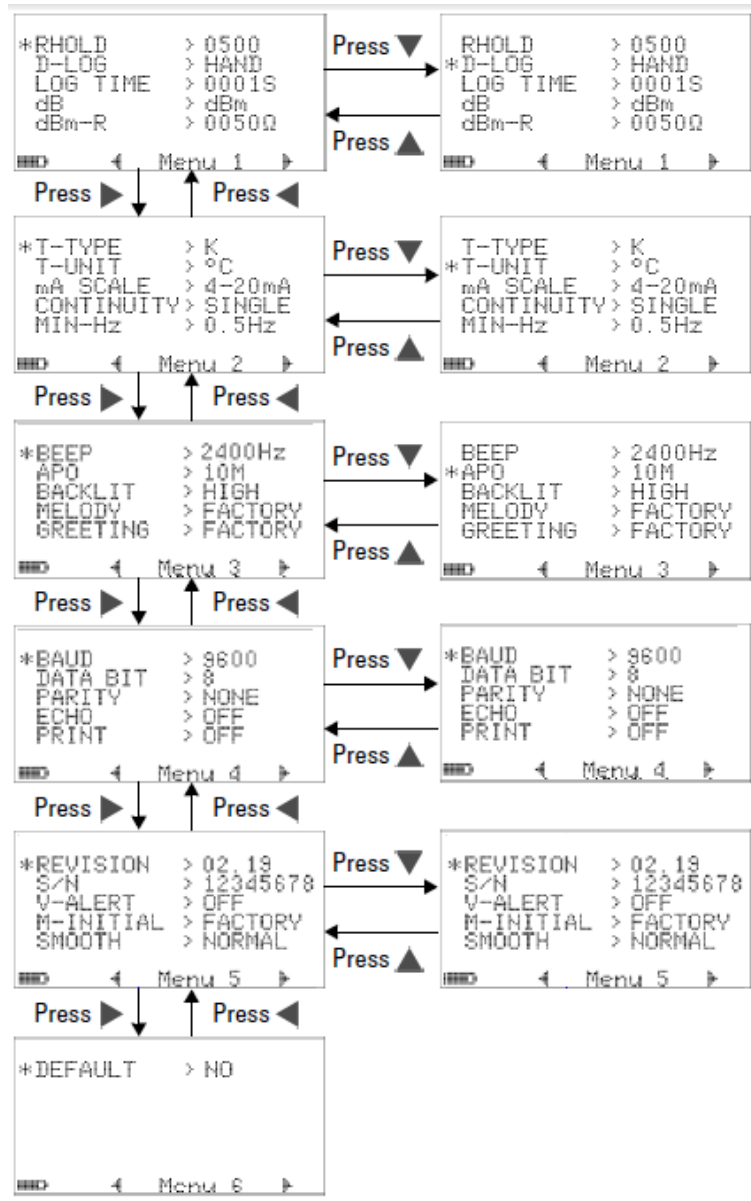

Figure 4-1 Setup menu screens

Setting Data Hold/Refresh Hold mode

- 1 Set menu item RHOLD to “OFF” to enable Data Hold mode (manual trigger by key or bus via remote control).
- 2 Set menu item RHOLD within the range of 100 to 9900 to enable Refresh Hold mode (automatic trigger). Once the variation of measured values exceeds this value (which is the variation count), the Refresh Hold will be ready to trigger and hold a new value.

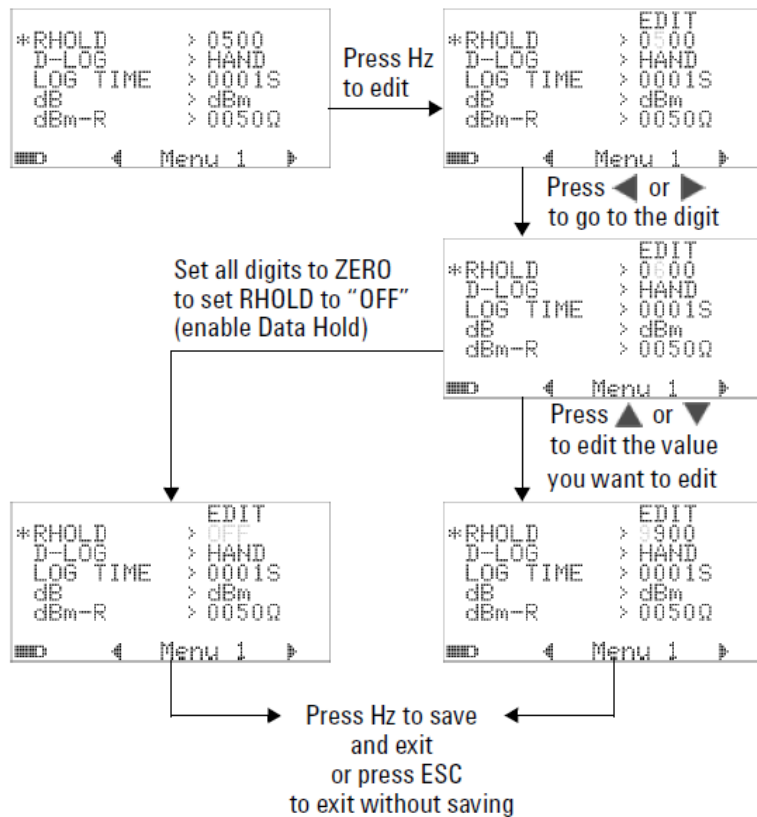

Figure 4-2 Data Hold/Refresh Hold setup

Setting data logging mode

- 1 Set to “HAND” to enable manual (hand) data logging, or set to “TIME” to enable interval (time) data logging. Refer to [Figure 4-3](#) below.

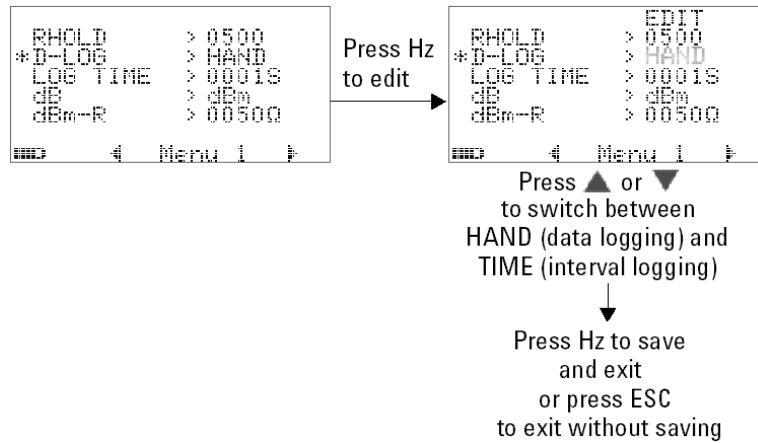

Figure 4-3 Data logging setup

- 2 For interval (time) data logging, set the LOG TIME within the range of 0001 second to 9999 seconds to specify the data logging interval.

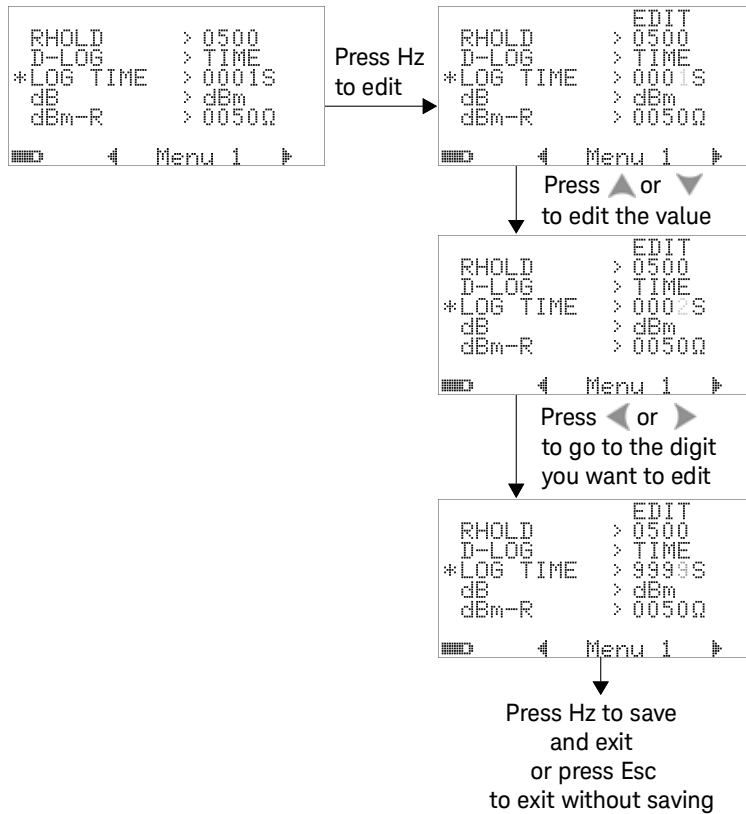

Figure 4-4 Log time setup for interval (time) logging

Setting dB measurement

The decibel unit can be disabled by setting this to “OFF”. The available options are dBm, dBV, and OFF. For dBm measurement, the reference impedance can be set by the “dBm-R” menu item.

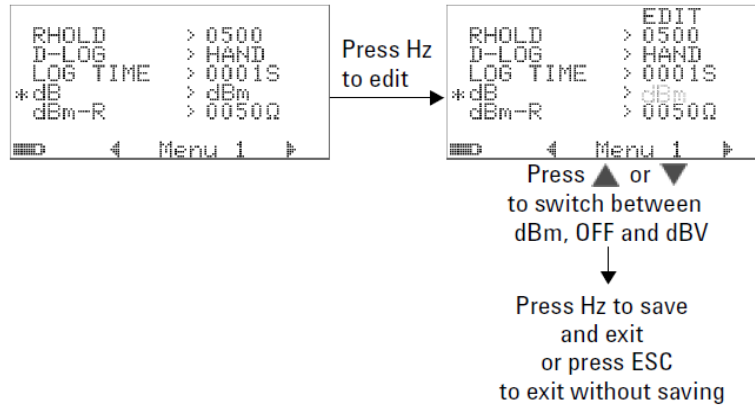

Figure 4-5 Decibel measurement setup

Setting reference impedance for dBm measurement

The reference impedance for dBm measurement can be set to any value within the range of 1 to 9999 Ω . The default value is 50 Ω .

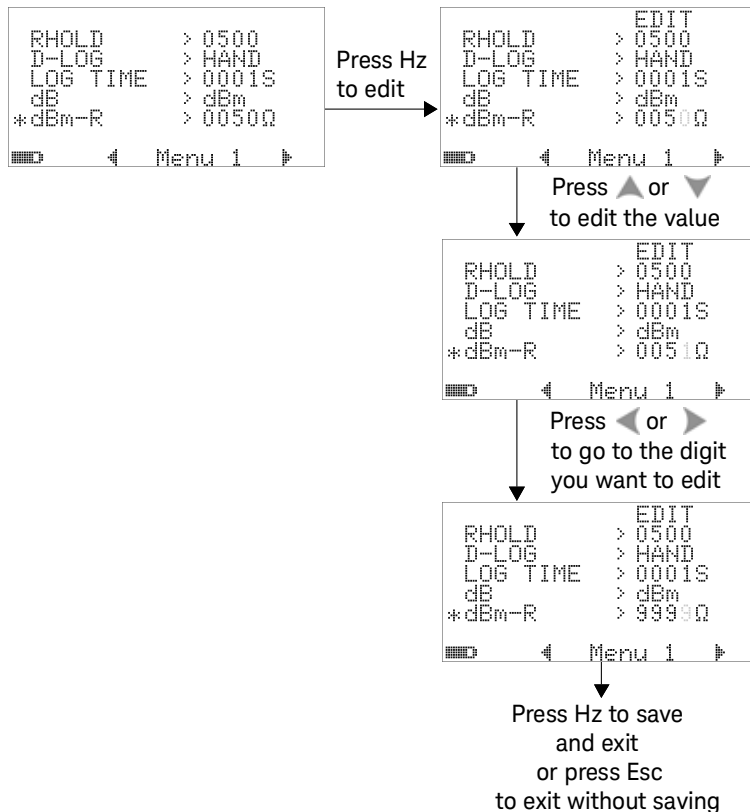

Figure 4-6 Setting up the reference impedance for dBm unit

Setting thermocouple types

The types of thermocouple sensor that can be selected are J-type and K-type. The default type is K-type.

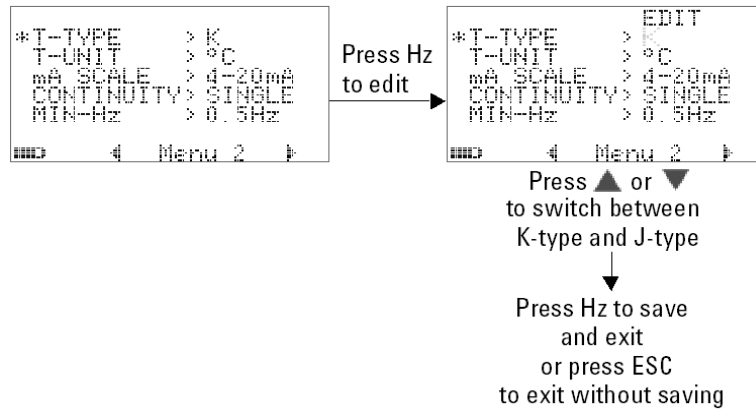

Figure 4-7 Thermocouple type setup

Setting temperature unit

The temperature unit setting at power on

Four combinations of displayed unit(s) are available:

- 1 Celsius only: °C single display.
- 2 Celsius/Fahrenheit: °C/°F dual display; °C on primary, and °F on secondary.
- 3 Fahrenheit only: °F single display.
- 4 Fahrenheit/Celsius: °F/°C dual display; °F on primary, and °C on secondary.

NOTE

The temperature unit setting at power on is locked by default and thus temperature unit editing is not allowed unless it is unlocked.

Press and hold  for more than 1 second to unlock the temperature unit setting and the lock sign will be removed.

Press  for more than 1 second to lock the temperature unit setting.

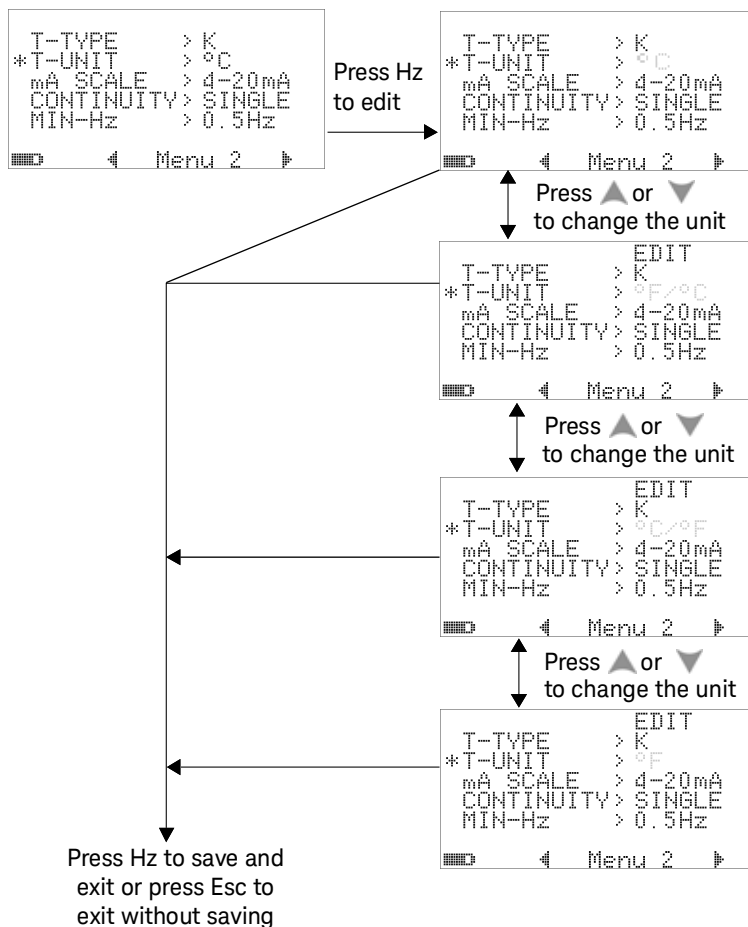

Figure 4-8 Temperature unit setup

Setting percentage scale readout

This setting converts the DC current measurement display to percentage scale readout: 0% to 100% based on a range of 4 mA to 20 mA or 0 mA to 20 mA. For example, a 25% readout represents a DC current of 8 mA for the 4 mA to 20 mA range, or a DC current of 5 mA for the 0 mA to 20 mA range. To disable this function, set this to “OFF”.

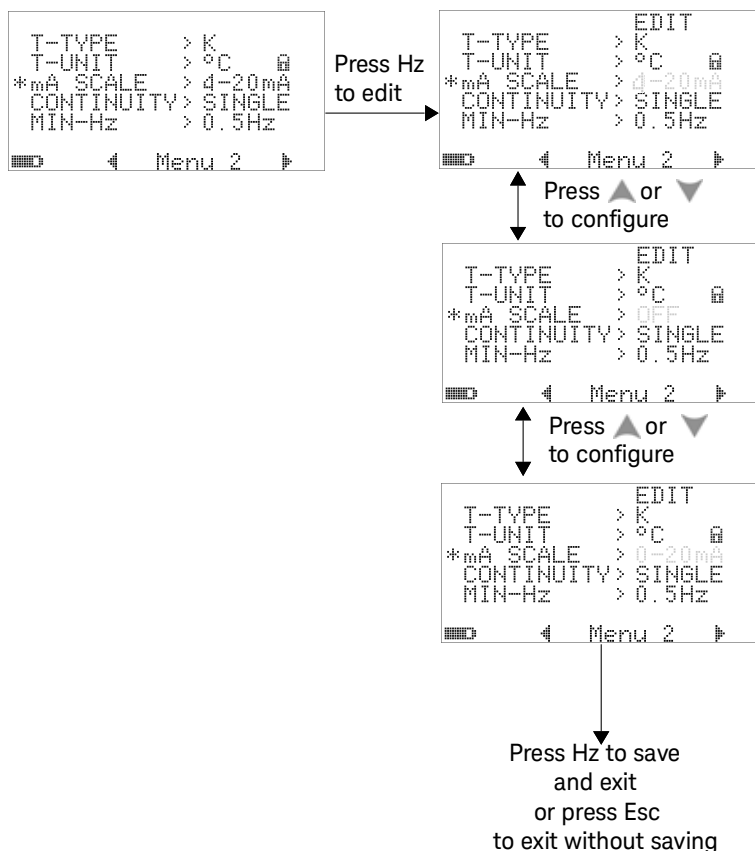

Figure 4-9 Setting up percentage scale readout

Sound setting for continuity test

This setting determines the sound used in the continuity test. Select "SINGLE" for a single-frequency beep, select "OFF" for a silent beep, or select "TONE" for a continuous string of beeps with varying frequencies.

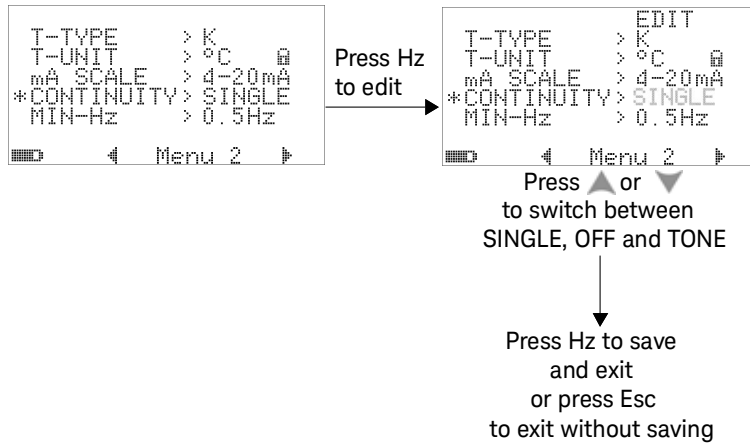

Figure 4-10 Choosing the sound used in continuity test

Setting minimum measurable frequency

The setup for minimum measurable frequency will influence the measurement rates for frequency, duty cycle, and pulse width. The typical measurement rate as defined in the specification is based on a minimum measurable frequency of 1 Hz.

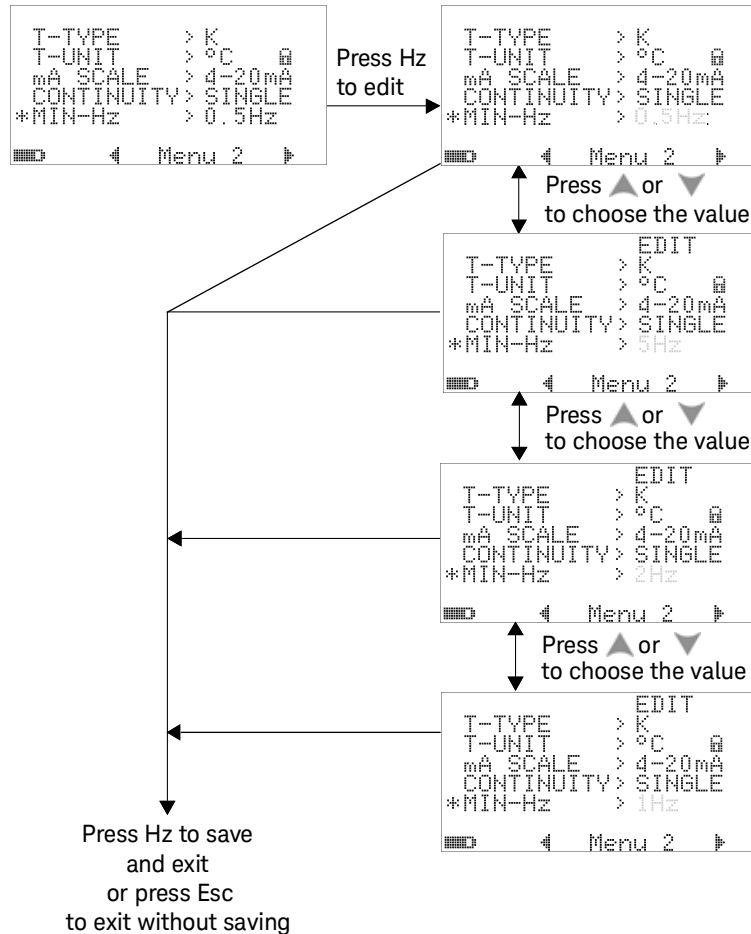

Figure 4-11 Minimum frequency setup

Setting beep frequency

The beep frequency can be set to 4800 Hz, 2400 Hz, 1200 Hz, or 600 Hz. “OFF” disables the beep.

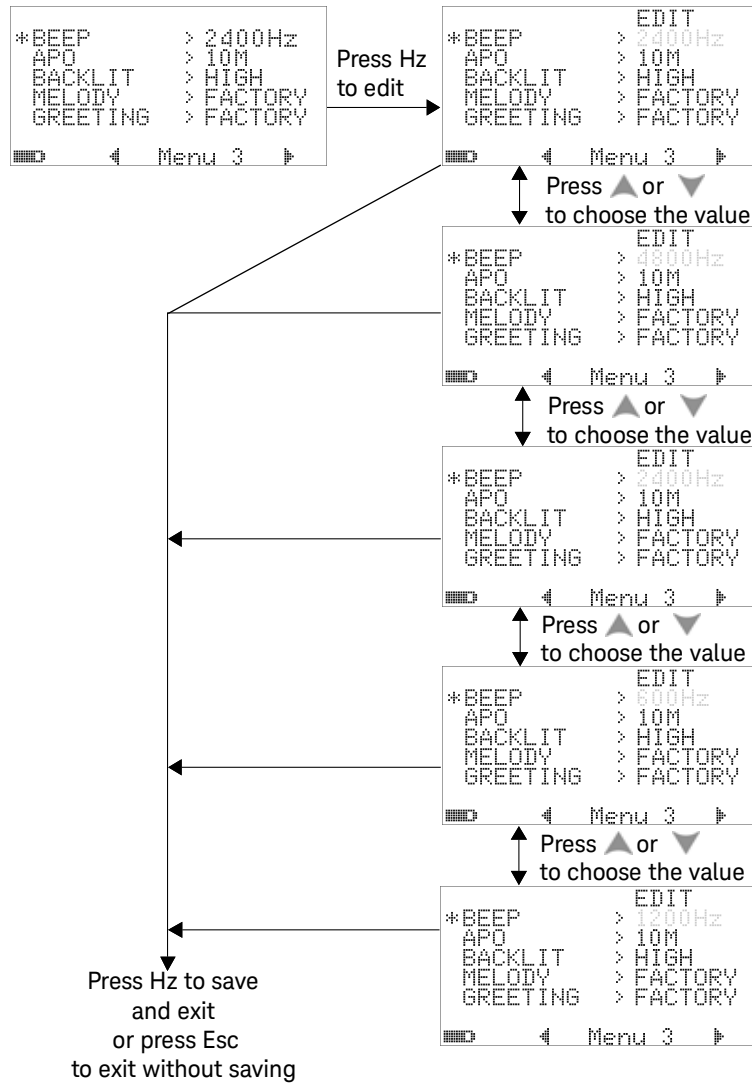



Figure 4-12 Beep frequency setup

Setting Auto Power Off mode

- To enable Auto Power Off (APO) set the timer to any value within the range of 1 to 99 minutes.
- The multimeter may turn off automatically (with APO enabled) if neither of the following happens within that time period:
 - Any push-button is pressed.
 - A measurement function is changed.
 - Dynamic recording is set.
 - 1 ms peak hold is set.
 - APO is disabled in the Setup mode.
- To activate the multimeter after auto power off, simply press any button or change the rotary switch position.
- To disable APO, select OFF. When APO is disabled, the  annunciator will be turned off. The multimeter will remain on until you manually turn the rotary switch to the OFF position.

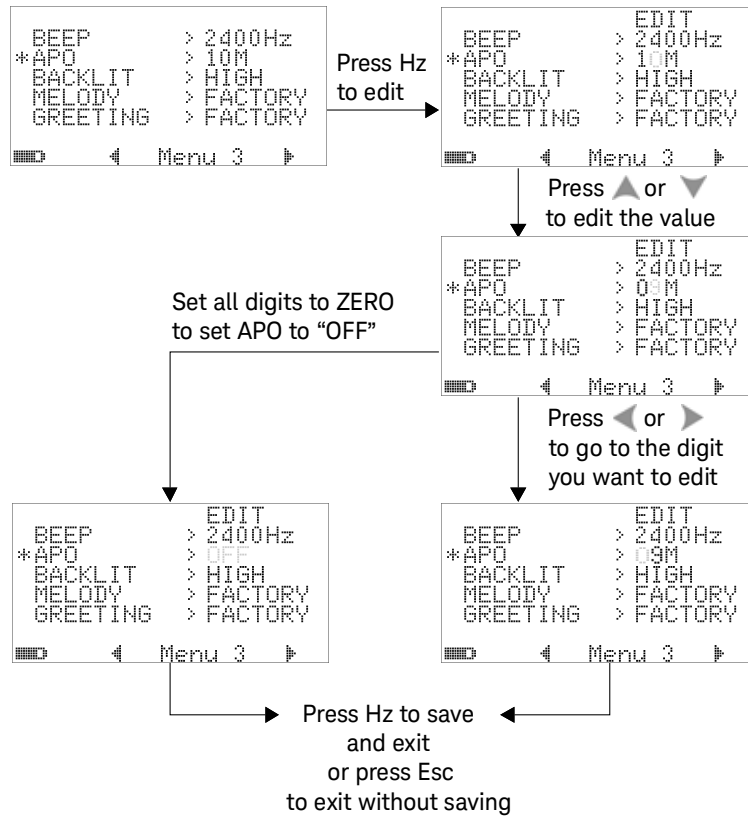

Figure 4-13 Automatic power saving setup

Setting power-on backlight brightness level

The brightness level that is displayed when the multimeter turns on can be set to HIGH, MEDIUM, or LOW.

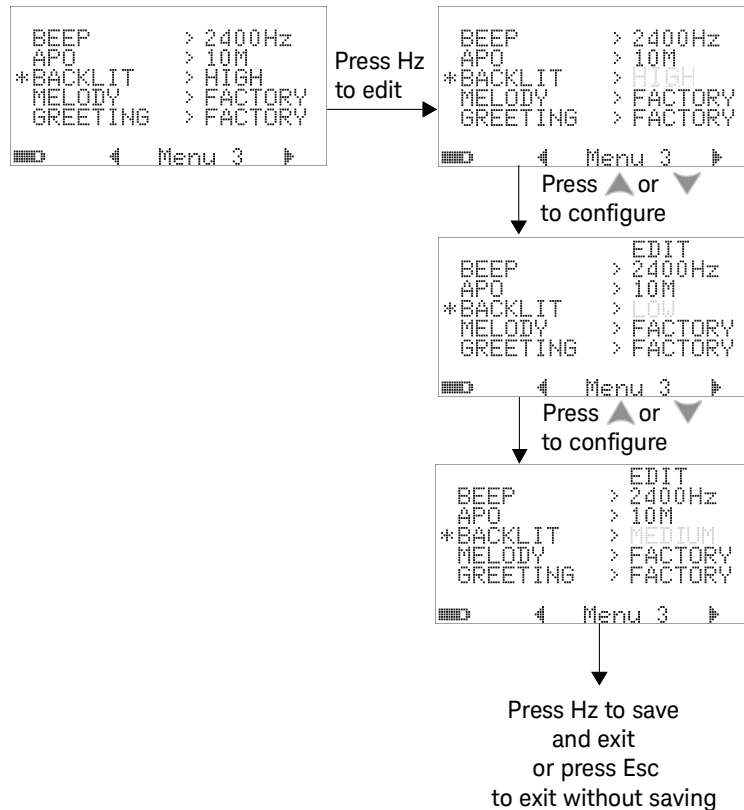



Figure 4-14 Power-on backlight setup

While using the multimeter, you may adjust the brightness at any time by pressing the  button.

Setting the power-on melody

The melody that is played when the multimeter turns on can be set to FACTORY, USER, or OFF. The USER setting is factory reserved.

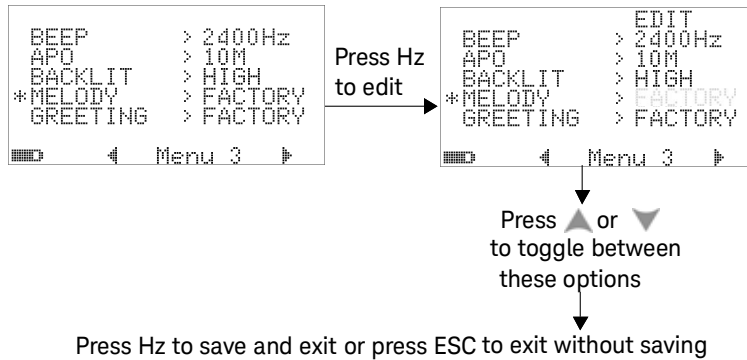

Figure 4-15 Power-on melody setup

Setting the power-on greeting screen

The greeting screen that is displayed when the multimeter turns on can be set to FACTORY, USER, or OFF. The USER setting is factory reserved.

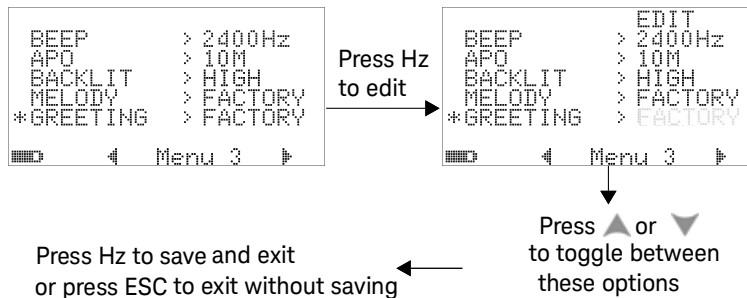

Figure 4-16 Power-on greeting setup

Setting baud rate

The baud rate used in the remote communication with a PC can be set as 2400, 4800, 9600, or 19200 bits/second.

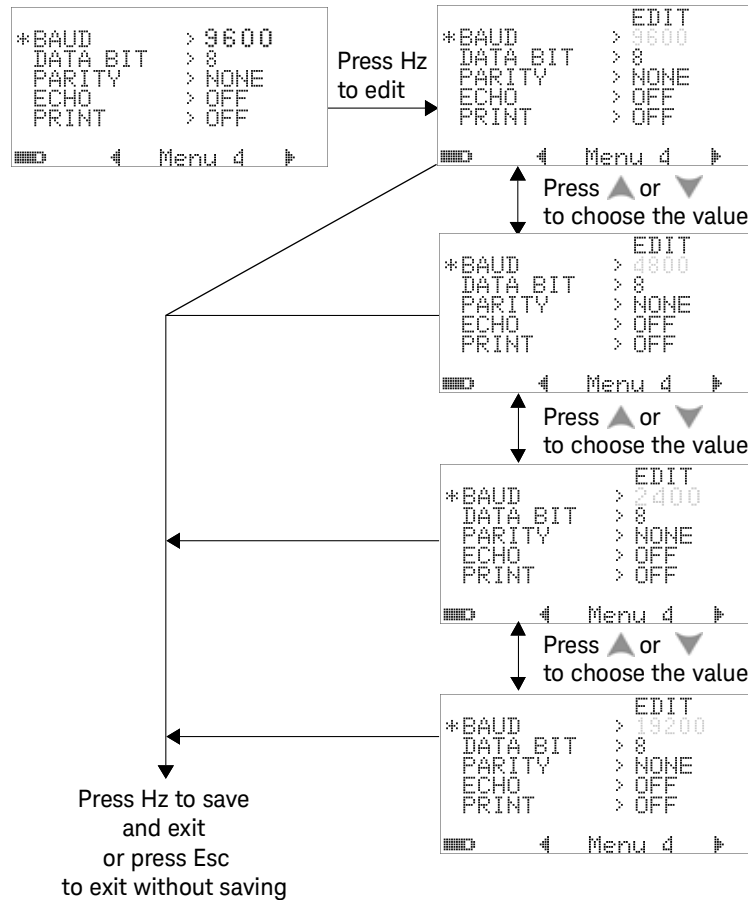

Figure 4-17 Baud rate setup for remote control

Setting data bits

The number of data bits (data width) for remote communication with a PC can be set to either 8 or 7 bits. The number of stop bit is always 1, and this cannot be changed.

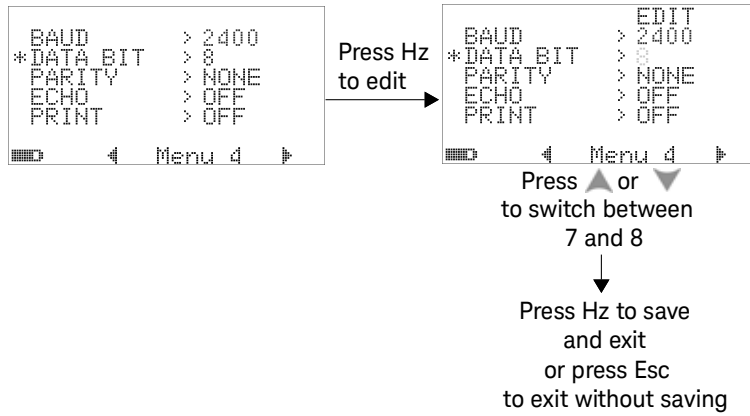

Figure 4-18 Data bits setup for remote control

Setting parity check

The parity check for remote communication with a PC can be set to either NONE, ODD, or EVEN.

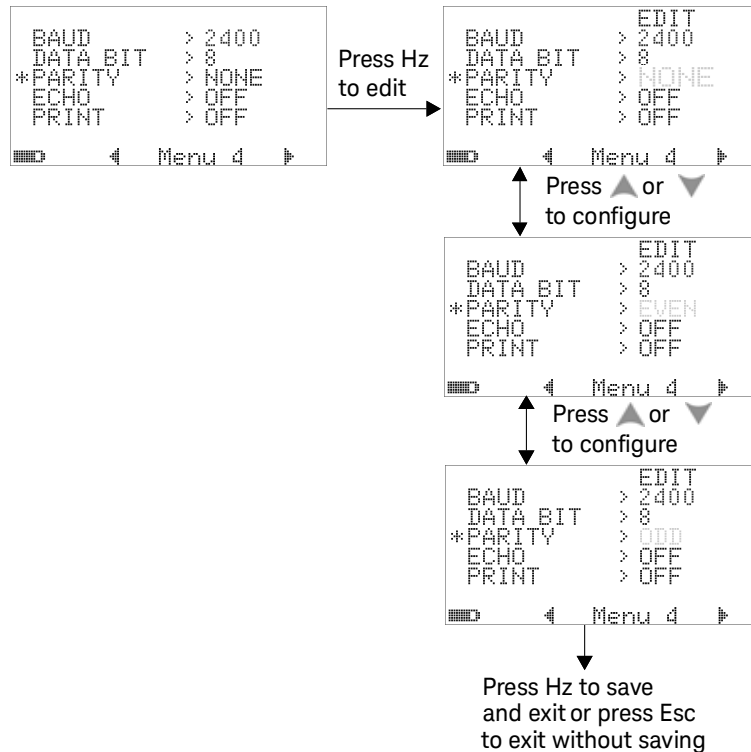

Figure 4-19 Parity check setup for remote control

Setting echo mode

- Turning echo mode to "ON" enables the transmitted characters to be echoed on the PC in remote communication.
- This is useful when developing PC programs which use SCPI commands. It is recommended that you disable this function during normal operation.

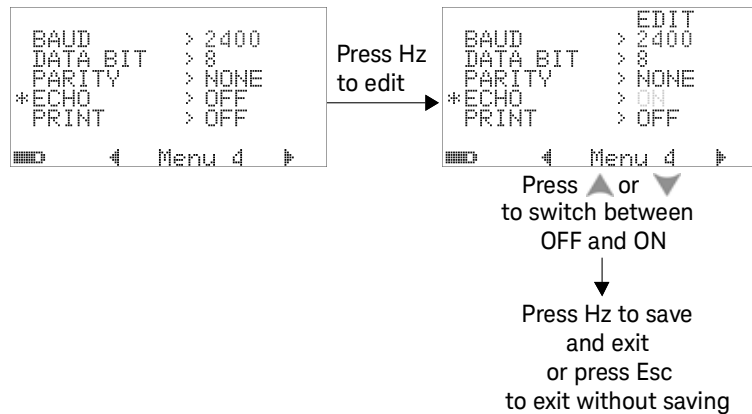



Figure 4-20 Echo mode setup for remote control

Setting print mode

Turning print mode “ON” enables the printing of measured data to a PC that is connected to the multimeter via the remote interface when a measurement cycle is completed.

In this mode, the multimeter continuously sends the latest data to the host, but does not accept any commands from the host.

The  indicator flashes during print operation.

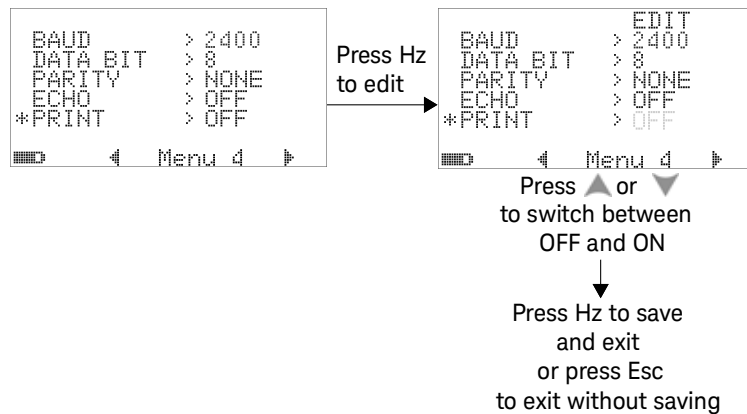

Figure 4-21 Print mode setup for remote control

Revision

The revision number of the firmware will be indicated.

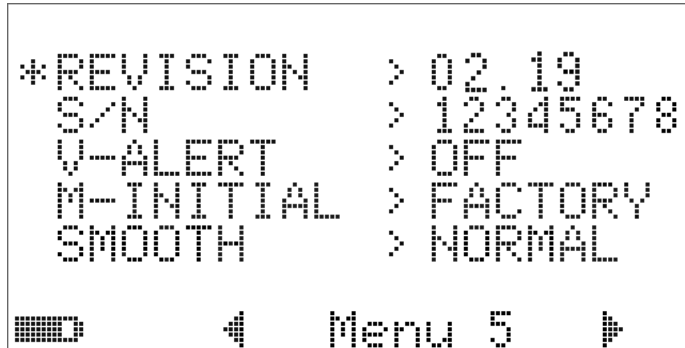

Figure 4-22 Revision number

Serial number

The last 8 digits of the serial number will be indicated.

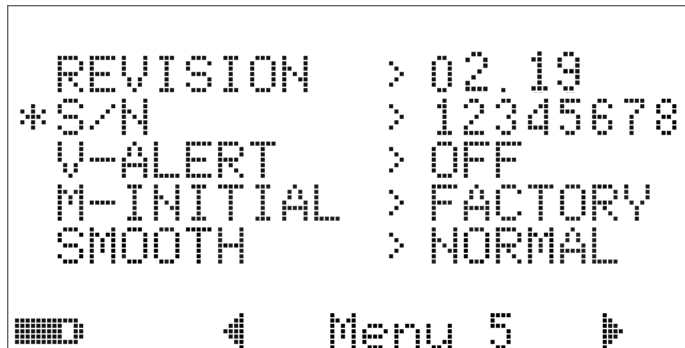

Figure 4-23 Serial number

Voltage alert

To enable an alert tone for overvoltage, select an overvoltage value within the range of 1 V to 1010 V.

To disable this function, set all digits to 0 (“OFF”).

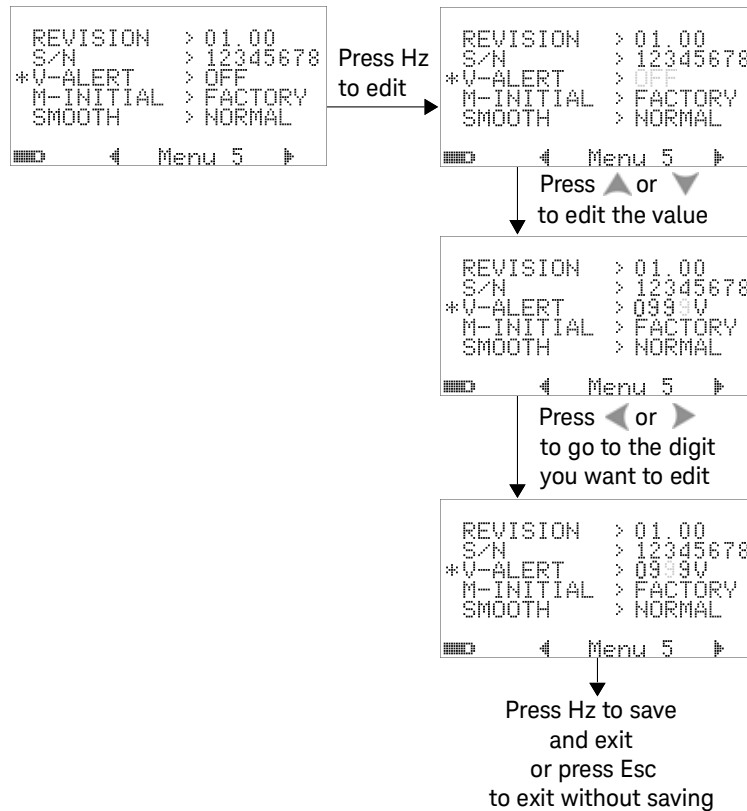







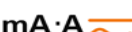
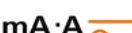



Figure 4-24 Voltage alert setup



M-initial

You may select the initial measurement functions as FACTORY or USER. The initial measurement functions and range can be set according to [Table 4-2](#) below.

Table 4-2 Available settings for M-initial

Function position	Function setting	Range setting
F1 	AC V	Auto or manual ranges
F2 	DC V, AC V, AC+DC V	Auto or manual ranges
F3 	DC mV, AC mV, AC+DC mV	Auto or manual ranges
F4 	Ohm, nS	Auto or manual ranges
F5 	Diode, frequency counter	No range setting
F6 	Temperature, capacitance	Auto or manual ranges
F7 	DC μ A, AC μ A, AC+DC μ A	Auto or manual ranges
F8 	DC mA, AC mA, AC+DC mA	Auto or manual ranges
F8A 	DC A, AC A, AC+DC A	Auto or manual ranges
F9 	29 different frequencies	Duty cycle = $(N/256) \times 100\%$ Pulse width = $(N/256) \times (1/\text{frequency})$

Each rotary switch position is assigned a default measurement function and a default measurement range.

As example, when you turn the rotary switch to the  position, the initial measurement function is diode measurement according to the default factory setting. In order to choose the frequency counter function you require, press the  button.

For another example, when you turn the rotary switch to the $\sim V$ position, the initial measurement range is Auto according to default factory setting. In order to choose a different range, you will have to press the **Range** button.

If you prefer to have a different set of initial measurement functions, change the M-INITIAL setting to USER, and press the **Hz** button. The multimeter will then enter the **INIT** pages. Please refer to [Figure 4-25](#).

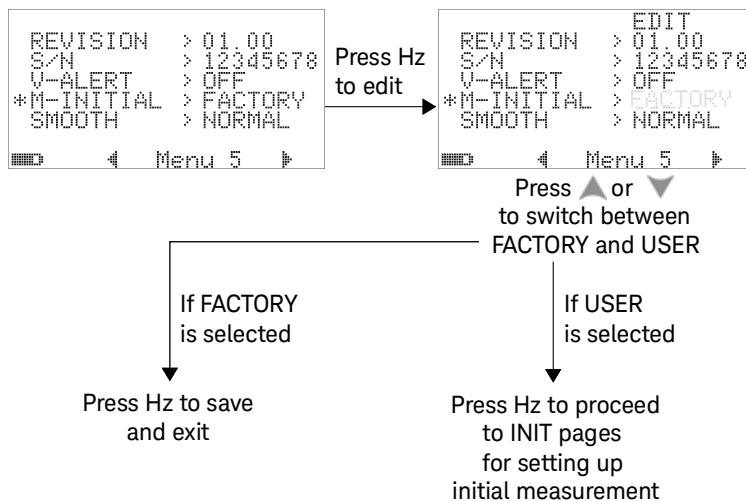

Figure 4-25 Setting initial measurement functions

In the **INIT** pages, you may define your preferred initial measurement functions. Please refer to [Figure 4-26](#).

Press **◀** or **▶** to navigate between the two INIT pages. Press **▲** or **▼** to choose which initial function you want to change.

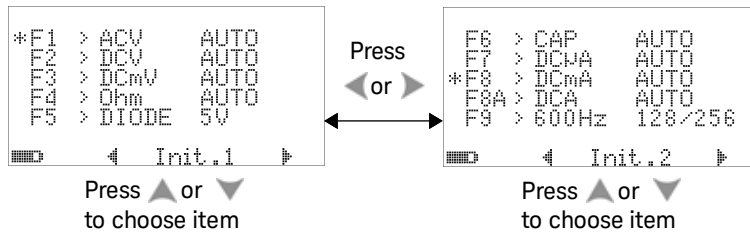

Figure 4-26 Navigating between the initial functions pages

Then press **Hz** to enter the **EDIT** mode.

In the **EDIT** mode, Press \uparrow or \downarrow to change the initial (default) measurement range of a selected function. For example, [Figure 4-27](#) below shows the initial range of the AC voltage measurement function at the F1 position changed to 1000 V (default was Auto).

Press \uparrow or \downarrow to change the initial measurement function of a selected rotary switch position. For example, [Figure 4-27](#) below shows the initial measurement function of the F5 position changed from DIODE to FC (frequency counter).

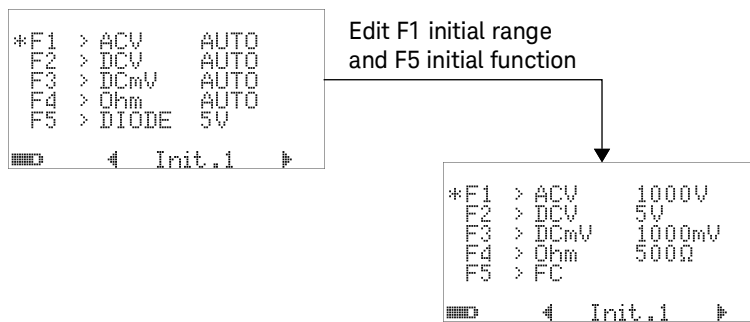

Figure 4-27 Editing initial measurement function/range

4 Changing the Default Settings

As another example, [Figure 4-28](#) below illustrates that:

- The F6 default function is changed from capacitance measurement to temperature measurement;
- The F7 default measurement range for DC μA is changed from Auto to 5000 μA ;
- The F8 default measurement range for DC mA is changed from Auto to 50 mA;
- The F8A default measurement range for DC A is changed from Auto to 5 A;
- The F9 default output values for pulse width and duty cycle are both changed from the 128th step (0.8333 ms for pulse width and 50.000% for duty cycle) to the 255th step (1.6601 ms for pulse width and 99.609%).

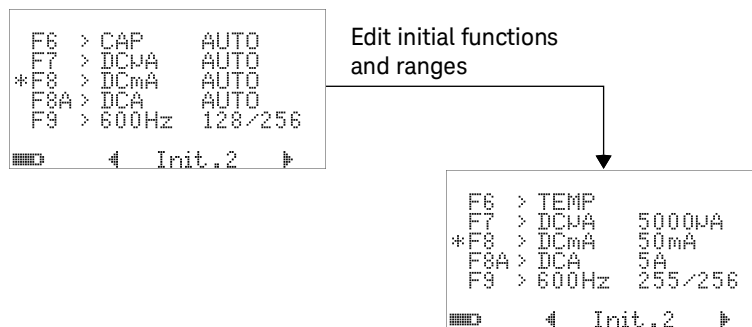

Figure 4-28 Editing initial measurement function/range and initial output values

After making the desired changes, press  to save the changes. Press  to exit the **EDIT** mode.

If you reset the multimeter to its default factory settings (see [“Returning to default factory settings”](#) on page 142), your settings for M-INITIAL will also revert to the factory defaults.

Smooth refresh rate

The SMOOTH mode (FAST, NORMAL or SLOW options) is used to smoothen the refresh rate of the readings, in order to reduce the impact of unexpected noise and helps to get a stable reading. It applies to all measurement functions except capacitance and frequency counter (including duty cycle and pulse width measurements). The default option is NORMAL.

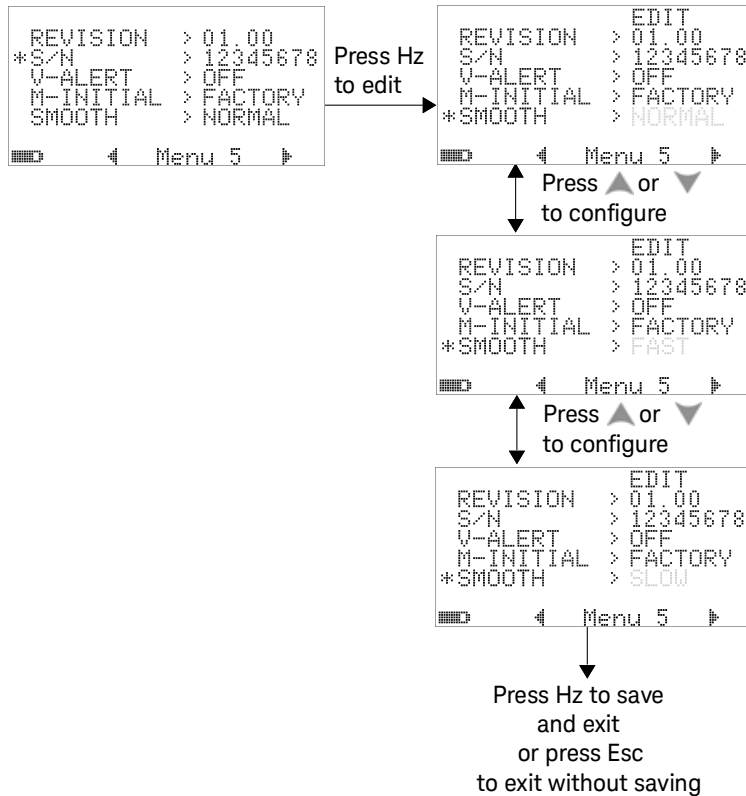

Figure 4-29 Refresh rate for primary display readings

Returning to default factory settings

- Set to "YES", then press  for more than 1 second to reset to default factory settings (all except the temperature setting).
- The Reset menu item automatically reverts to menu page 1 after a reset has taken place.



Figure 4-30 Resetting to default factory settings

Setting the battery type

The battery type for the multimeter can be set to either 7.2 V or 8.4 V.

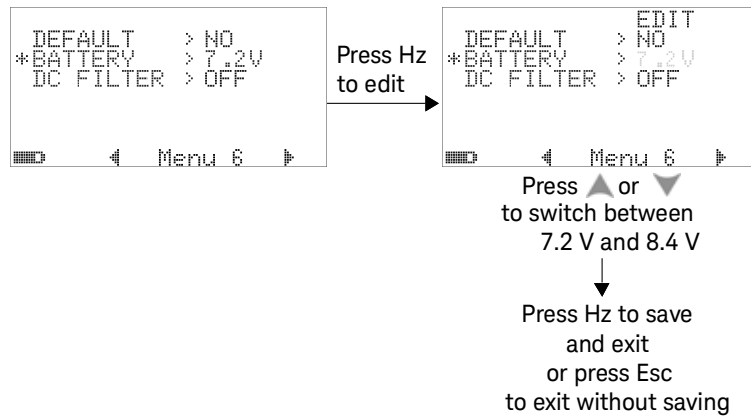

Figure 4-31 Battery type selection

Setting the Filter

This setting is used to filter AC signals in the DC measuring path. The DC filter is set to “ON” by default.

Table 4-3 Firmware version 2.25 or older

Parameter	Range	Default setting
FILTEr	on or OFF	oFF

Table 4-4 Firmware version 2.26 or newer

Parameter	Range	Default setting
FILTEr	on or OFF	oN

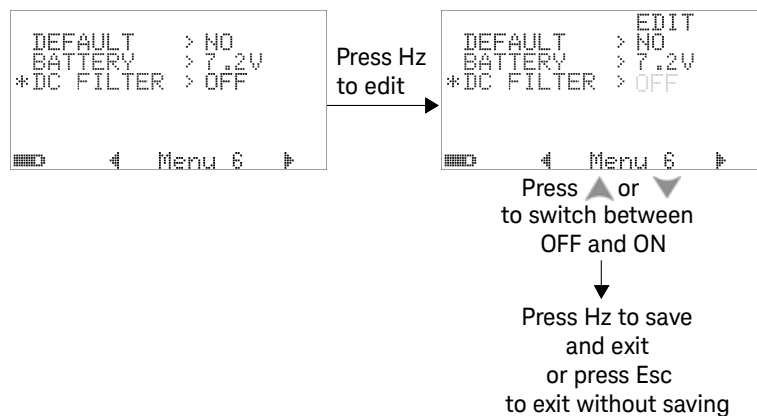

Figure 4-32 Filter

NOTE

- When the Filter is enabled, the measurement speed may decrease during DC voltage measurement.
- During AC or Hz measurement (on primary or secondary display), DC filter will be automatically disabled.

5 Maintenance

Introduction	146
Replaceable Parts	163

This chapter will help you to troubleshoot if the U1253B true RMS OLED multimeter malfunctions.

Introduction

CAUTION

Any repair or service which is not covered in this manual should only be performed by qualified personnel.

General maintenance

WARNING

Ensure that terminal connections are correct for a particular measurement before making the measurement. To avoid damaging the device, do not exceed the rated input limit.

Dirt or moisture in the terminals can distort readings. Cleaning procedures are as follows:

- 1 Turn the multimeter off and remove the test leads.
- 2 Turn the multimeter over and shake out any dirt that may have accumulated in the terminals.
- 3 Wipe the case with a damp cloth and mild detergent – do not use abrasives or solvents. Wipe the contacts in each terminal with a clean cotton swab moistened with alcohol.

Battery replacement

This multimeter is powered by a 9 V Ni-MH rechargeable battery (7.2 nominal voltage) or 9 V Ni-MH rechargeable battery (8.4 V nominal voltage). Use only the specified type (refer to [Figure 5-1](#) below). Alternatively you may also use a 9 V Alkaline battery (ANSI/NEDA 1604A or IEC 6LR61) or a 9 V Carbon-zinc battery (ANSI/NEDA 1604D or IEC6F22) to power the U1253B.

To ensure that the multimeter performs as specified, it is recommended that you replace the battery as soon as the low-battery indicator is displayed flashing. If your multimeter has a rechargeable battery inside, please go to [“Charging the battery”](#) on page 150. The procedures for battery replacement are as follows:

NOTE

The U1253B comes supplied with a 9 V Ni-MH rechargeable battery, 8.4 V nominal voltage.

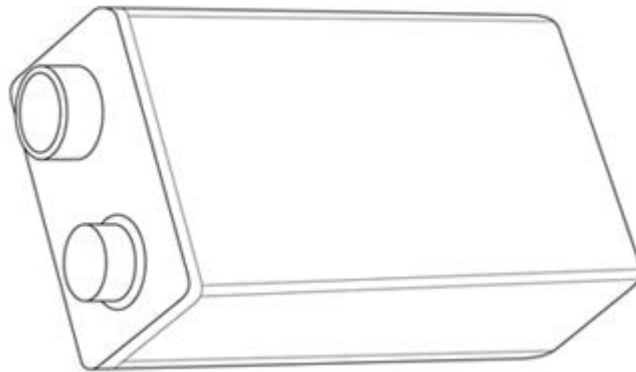

Figure 5-1 9 V rectangular battery

- 1 On the rear panel, turn the screw on the battery cover counterclockwise from the LOCK position to OPEN.

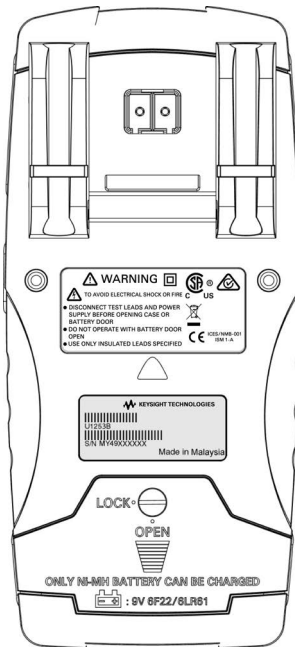

Figure 5-2 Rear panel of the Keysight U1253B True RMS OLED Multimeter

- 2 Slide the battery cover down.
- 3 Lift the battery cover up.
- 4 Replace with the specified battery.
- 5 Reverse the procedures of opening the cover to close it.

NOTE

List of compatible batteries for the Keysight U1253B:

- 9 V Alkaline non-chargeable battery (ANSI/NEDA 1604A or IEC 6LR61)
 - 9 V Carbon-zinc non-chargeable battery (ANSI/NEDA 1604D or IEC6F22)
 - 9 V size 300 mAH Ni-MH rechargeable battery, 7.2 V nominal voltage
 - 9 V size 250 mAH Ni-MH rechargeable battery, 8.4 V nominal voltage
-

Storage considerations

CAUTION

To avoid instrument damage from battery leakage:

- Always remove dead batteries immediately.
 - It is recommended that the battery is removed and stored separately if the multimeter is to be unused for long periods of time.
-

After the first charge, it is recommended that you fully charge the battery periodically, even when it is not in use. This is because the Ni-MH rechargeable battery pack may drain with time.

NOTE

The performance of the rechargeable battery may degrade with time.

Charging the battery

WARNING

Do not discharge the battery by shorting it or subjecting it to reverse polarity. Make sure a battery is rechargeable before charging it. Do not rotate the rotary switch when the battery is being charged.

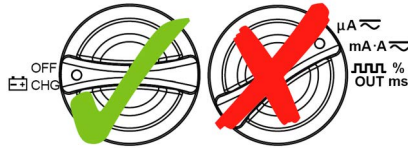
CAUTION



- Do not rotate the rotary switch from  **OFF** **CHG** position when charging the battery.
- Perform battery charging only with a 9 V Ni-MH rechargeable battery (7.2 V nominal voltage) or 9 V size Ni-MH rechargeable battery (8.4 V nominal voltage)
- Disconnect test leads from all the terminals when charging the battery.
- Ensure proper insertion of battery in the multimeter, and follow the correct polarity.

NOTE

For the battery charger, the mains supply voltage fluctuations must not exceed $\pm 10\%$.

A new rechargeable battery comes in a discharged condition and must be charged before use. Upon initial use (or after a prolonged storage period), the battery may require three to four charge/discharge cycles before achieving maximum capacity. To discharge, simply run the multimeter under the battery's power until it shuts down or the low battery warning appears.

It is strongly recommended that you use the specified 24-volt DC adapter included as an accessory to charge the rechargeable battery. Never rotate the rotary switch while the battery is being charged because a DC voltage of 24 V is applied to the charging terminals. Follow the procedures below to charge the battery:

- 1 Remove the test leads from the multimeter.
- 2 Turn the rotary switch to  **CHG**.
- 3 Plug the DC adapter into a power outlet.
- 4 Insert the red (+) and black (-) banana plugs (4 mm plugs) of the DC adapter to the  **CHG** and **COM** terminals respectively. Ensure that the polarity of the connection is correct.

NOTE

The DC adapter can be replaced with a DC power supply set at DC 24 V with an overcurrent limit of 0.5 A.

- 5 The display will show a countdown timer of 10 seconds for the self-test to start. The multimeter will output short single-tone sounds to remind you to charge the battery. Press  to start charging the battery, or the multimeter will automatically start charging after 10 seconds. It is recommended not to charge the battery if the battery capacity is over 90%.



Figure 5-3 Self-testing time display

Table 5-1 Battery voltage and corresponding percentage of charges in standby and charging modes

Condition	Battery voltage	Proportional percentage
Trickle	7.0 V to 9.6 V	0% to 100%
Charging	7.2 V to 10.0 V	0% to 100%

- 6** After pressing  or in the case of a restart, the multimeter will perform a self-test to check whether the battery inside the multimeter is a rechargeable battery. This self-test will take 3 minutes. Avoid pressing any of the push-buttons during the self-test. If there is any error, the multimeter will display error messages as shown in [Table 5-2](#) on page 153.



Figure 5-4 Performing self-test

Table 5-2 Error messages

Error	Error message
<p>OVER LIMIT</p> <ol style="list-style-type: none"> 1 No battery inside 2 Faulty battery 3 Battery is fully charged 	
<p>CHARGE ERROR</p> <ol style="list-style-type: none"> 1 If charging battery more than 12 V or less than 5 V 2 In 3 minutes, if the battery voltage does not go upwards then charge error 	

NOTE

- If the **OVER LIMIT** message is displayed, and there is a battery inside the multimeter, please do not charge the battery.
- If the **CHARGE ERROR** message is displayed, check whether the battery is the specified type. For the correct battery type, refer to “**List of compatible batteries for the Keysight U1253B:**” on page 149. Please ensure that the battery in the multimeter is the specified type of rechargeable battery before charging it. After replacing any wrong battery with the correct specified type of rechargeable battery, press  to redo the self-test. Replace with a new battery if the **CHARGE ERROR** message is again displayed.



Figure 5-5 Charging mode

- 7 The smart charging mode will start if the battery passes the self-test. The charging time is limited to within 220 minutes. This ensures that the battery will not be charged for more than 220 minutes. The display will count down the charging time. When battery charging is in progress, none of the push-buttons can be operated. To avoid overcharging the battery, the charging may be stopped with an error message during the charging process.

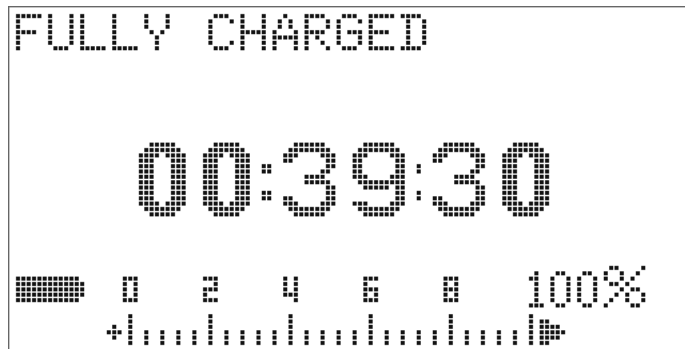

Figure 5-6 Fully charged and in the trickle state

- 8 Once the charging is completed, the **FULLY CHARGED** message will be displayed. A trickle charging current will be drawn to maintain the battery capacity.
- 9 Remove the DC adapter when the battery has been fully charged.

CAUTION

Do not turn the rotary switch before removing the adapter from the terminals.

NOTE

Applicable for U1253B with Firmware version 3.06 and above.

In order to comply with US DOE & CA CEC regulation enforced on January 1, 2017, the trickle charge feature as described in [step 8](#) has been disabled. Once the charging is completed, the display will be cleared and multimeter will enter sleep mode.

Press any button to re-initiate the charging cycle from sleep mode.

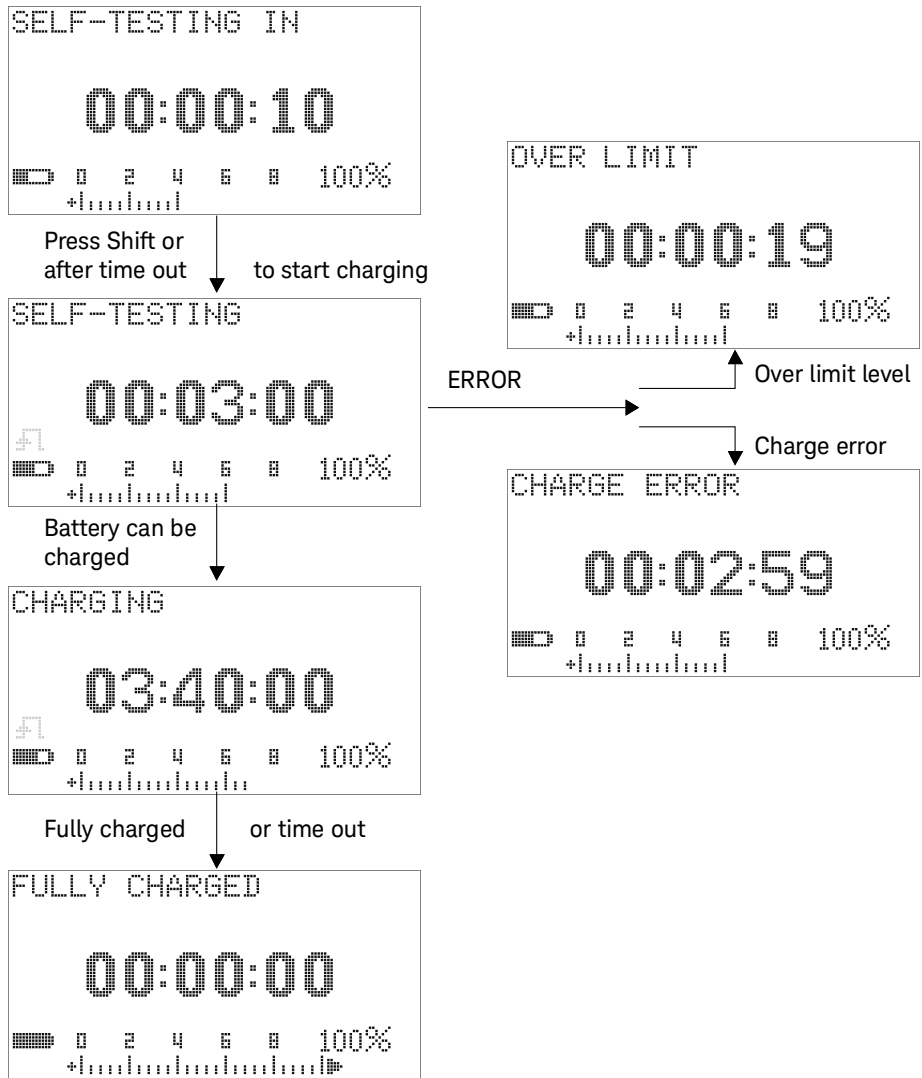

Figure 5-7 Battery charging procedures

Fuse checking procedure

It is recommended that you check the fuses of the multimeter before using it. Follow the instructions below to test the fuses inside the multimeter. Refer to [Figure 5-9](#) for the respective positions of Fuse 1 and Fuse 2.

- 1 Set the rotary switch to **nS** Ω .
- 2 Connect the red test lead to the input terminal $\Omega \cdot T$ **V·mV**.

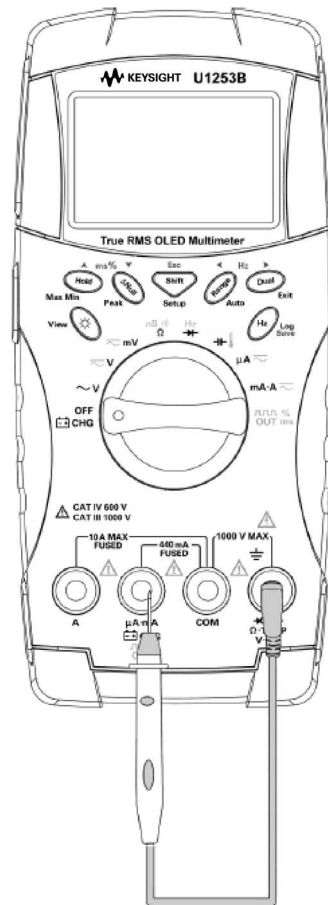

Figure 5-8 Fuse checking procedures

- 3 To test Fuse 1, place the tip of the test probe on the right half of input terminal **$\mu\text{A}\cdot\text{mA}$** . Ensure that the probe tip touches the metal inside the input terminal, as shown in [Figure 5-8](#).
 
- 4 To test Fuse 2, place and touch the tip of the test probe on the right half of input terminal **A**. Ensure that the probe tip touches the metal inside the input terminal.
- 5 Observe the reading on the instrument's display. Refer to [Table 5-3](#) for the possible readings that could appear.
- 6 Replace the fuse when **OL** is displayed.

Table 5-3 U1253B measurement readings for fuse checking

Current input terminal	Fuse	Fuse rating	Fuse OK (approximately)	Replace fuse
			Displayed readings	
$\mu\text{A}\cdot\text{mA}$	1	440 mA/1000 V	6.2 M Ω	OL
A	2	11 A/1000 V	0.06 Ω	OL

Fuse replacement

NOTE

This manual provides only the fuse replacement procedures, but not the fuse replacement markings.

Replace any blown fuse in the multimeter according to the following procedures:

- 1 Turn the multimeter off and disconnect the test leads. Ensure that the charging adapter is also removed, if it is attached to the multimeter.
- 2 Wear clean and dry gloves on your hands and avoid touching any components except the fuse(s) and plastic parts. It is not necessary to recalibrate the multimeter after replacing a fuse.
- 3 Remove the battery cover compartment.
- 4 Loosen two side screws and one lower screw on the bottom case and remove the bottom case.
- 5 Loosen the two screws on the top corners to take out the circuit board.
- 6 Gently remove the defective fuse by prying one end of the fuse loose and removing it from the fuse bracket.
- 7 Replace with a new fuse of the same size and rating. Make sure the new fuse is centered in the fuse bracket.
- 8 Ensure that the knob of the rotary switch on the top case and the corresponding switch on the circuit board remain at the OFF position.
- 9 Re-fasten the circuit board and the bottom cover.
- 10 Refer to [Table 5-4](#) on page 160 for the part number, rating, and size of the fuses.

Table 5-4 Fuse specifications

Fuse	Keysight part number	Rating	Size	Type
1	2110-1400	440 mA/1000 V	10 mm × 35 mm	Fast blow fuse
2	2110-1402	11 A/1000 V	10 mm × 38 mm	

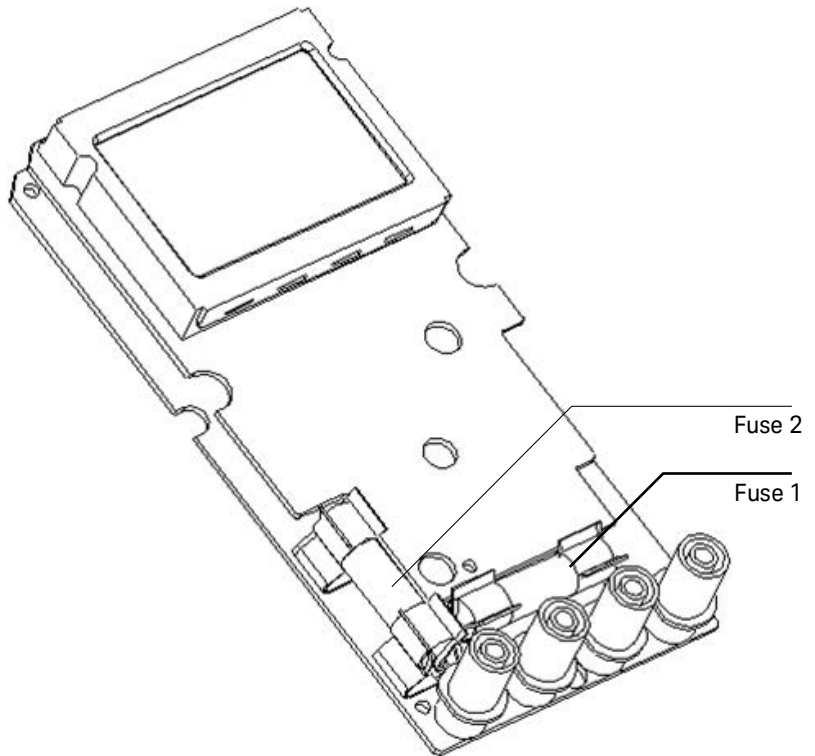

Figure 5-9 Fuse replacement

Troubleshooting

WARNING

To avoid electric shock, do not perform any servicing unless you are qualified to do so.

If the instrument fails to operate, check the battery and test leads. Replace them if necessary. After that, if the instrument still does not function, check to ensure that you have followed the operating procedures given in this instruction manual, before considering servicing the instrument.

When servicing the instrument, use only the specified replacement parts.

Table 5-5 on page 162 will assist you in identifying some basic problems and their solutions.

Table 5-5 Basic troubleshooting procedures

Malfunction	Troubleshooting procedure
No OLED display after switching ON	<ul style="list-style-type: none"> – Check battery. Charge or replace battery.
No beeper tone	<ul style="list-style-type: none"> – Check the Setup mode to verify whether the beeper function has been set to OFF. If so, select the desired driving frequency.
Failed to measure current	<ul style="list-style-type: none"> – Check the fuse.
No charging indication ^[a]	<ul style="list-style-type: none"> – Check 440 mA fuse. – Check external DC adapter to ensure that its output is DC 24 V and that the plugs are inserted properly into the charging terminals.
Battery life very short after full charge/ Battery not able to charge after pro-long storage period	<ul style="list-style-type: none"> – Check if the correct rechargeable battery is used. – Check if the correct nominal voltage level (7.2 V or 8.4 V) is selected in the battery setting at Setup Mode. – Try to charge and discharge for 2 or 3 cycles in order to maintain the battery's highest capacity. – NOTE: The performance of the rechargeable battery may degrade with time.
Remote control failure	<ul style="list-style-type: none"> – The Keysight logo on the IR-USB cable connected to the multimeter should be facing up. – Check the baud rate, parity, data bit, and stop bit (default is 9600, None, 8, and 1) in the Setup mode. – Ensure that the required driver for IR-USB has been installed.

Notes for basic troubleshooting procedures table:

[a] Never turn the rotary switch of the multimeter from the OFF position when it is charging.

Replaceable Parts

This section contains information for ordering replacement parts for your instrument. You can find the instrument support part list at Keysight's Test & Measurement Parts Catalog at: <http://www.keysight.com/find/parts>.

NOTE

This parts list includes a brief description of each part with applicable Keysight part number.

To order replaceable parts

You can order replaceable parts from Keysight using the Keysight part number.

NOTE

Not all parts listed are available as field replaceable parts.

To order replaceable parts from Keysight, do the following:

- 1 Contact your nearest Keysight Sales Office or Service Center.
- 2 Identify the parts by the Keysight part number shown in the support parts list.
- 3 Provide the instrument model number and serial number.

THIS PAGE HAS BEEN INTENTIONALLY LEFT BLANK.

6 Performance Tests and Calibration

Calibration Overview	166
Recommended Test Equipment	168
Basic Operating Tests	169
Test Considerations	172
Performance Verification Tests	173
Calibration Security	180
Adjustment Considerations	187
Calibration From Front Panel	192

This chapter contains the performance test and adjustment procedures.

Calibration Overview

This manual contains procedures for verifying the instrument performance, as well as procedures for making adjustments where necessary.

The performance test procedure verifies that the U1253B true RMS OLED multimeter is operating within its published specifications. The adjustment procedure ensure that the multimeter remains within its specifications until the next calibration.

NOTE

Make sure you have read **“Test Considerations”** on page 172 before calibrating the instrument.

Closed-case electronic calibration

The U1253B true RMS OLED multimeter features closed-case electronic calibration. In other words, no internal electro-mechanical adjustment is required. This instrument calculates correction factors based on the input reference signals you feed into it during the calibration process. The new correction factors are stored in nonvolatile EEPROM memory until the next calibration (adjustment) is performed. The contents of this nonvolatile EEPROM memory will not change even when the power is switched off.

Keysight Technologies' calibration services

When your instrument is due for calibration, contact your local Keysight Service Center to enquire about recalibration services.

Calibration interval

A one-year interval is adequate for most applications. Accuracy specifications are warranted only if calibration is performed at regular intervals. Accuracy specifications are not warranted beyond the one-year calibration interval. Keysight does not recommend extending calibration intervals beyond 2 years for any application.

Other recommendations for calibration

Specifications are only guaranteed within the specified period from the last calibration. Keysight recommends that readjustment should be performed during the calibration process for best performance. This will ensure that the U1253B true RMS OLED multimeter remains within its specifications. This calibration criterion provides the best long-term stability.

During performance verification tests, only the performance data is collected; these tests do not guarantee that the instrument will remain within the specified limits. The tests are only for identifying which functions need adjustment.

Please refer to the section **“Calibration count”** on page 200 and verify that all adjustments have been performed.

Recommended Test Equipment

The test equipment recommended for the performance verification and adjustment procedures is listed below. If the exact instrument is not available, substitute with another calibration standard of equivalent accuracy.

A suggested alternative method would be to use the Keysight 3458A 8½ – Digit Digital Multimeter to measure less accurate yet stable sources. The output value measured from the source can be entered into the instrument as the target calibration value.

Table 6-1 Recommended test equipment

Application	Recommended equipment	Recommended accuracy requirements
DC voltage	Fluke 5520A	< 20% of U1253B accuracy spec
DC current	Fluke 5520A	< 20% of U1253B accuracy spec
Resistance	Fluke 5520A	< 20% of U1253B accuracy spec
AC voltage	Fluke 5520A	< 20% of U1253B accuracy spec
AC current	Fluke 5520A	< 20% of U1253B accuracy spec
Frequency	Keysight 33250A	< 20% of U1253B accuracy spec
Capacitance	Fluke 5520A	< 20% of U1253B accuracy spec
Duty cycle	Fluke 5520A	< 20% of U1253B accuracy spec
Nanosiemens	Fluke 5520A	< 20% of U1253B accuracy spec
Diode	Fluke 5520A	< 20% of U1253B accuracy spec
Frequency counter	Keysight 33250A	< 20% of U1253B accuracy spec
	Fluke 5520A	< 20% of U1253B accuracy spec
Temperature	TM Electronics KMPC1MP (K-Type thermocouple extension)	–
Square wave	Keysight 53131A and Keysight 34401A	< 20% of U1253B accuracy spec
Short	Pomona MDP-S	–

Basic Operating Tests

These basic operating tests are for testing the basic operation of the instrument. Repair is required if the instrument fails any of these basic operating tests.

Testing the display

Press and hold the  button while turning on the multimeter to view all the OLED pixels. Check for dead pixels.

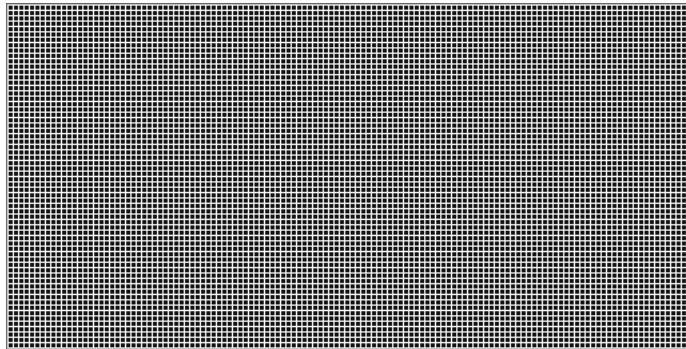



Figure 6-1 Displaying all OLED pixels

Current terminals test

This test determines whether the input warning for the current terminals is functioning properly.

Turn the rotary switch to any non-off position other than **mA·A** . Insert the test leads to the **A** and **COM** terminals. An error message **Error ON A INPUT** (as shown in [Figure 6-2](#)) will be displayed on the secondary display, and a continuous beep will persist until the positive lead is removed from the **A** terminal.

NOTE

Before conducting this test, make sure the beep function is not disabled in Setup.

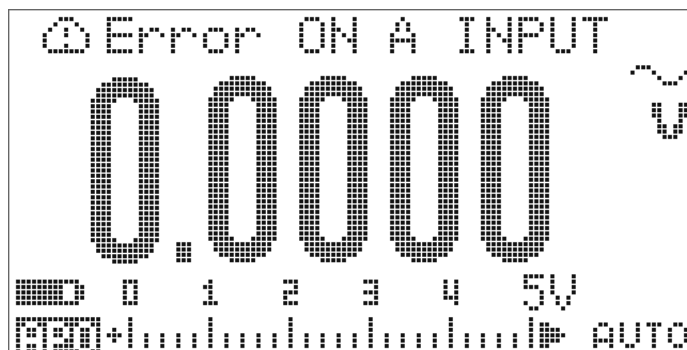

Figure 6-2 Current terminal error message

Charge terminals alert test

This test determines whether the charge terminal alert is functioning properly.

Set the rotary switch to any position other than **OFF** **CHG**, **mA·A**, **μA**, or **OUT %**.

Provide a voltage level more than 5 V to the **CHG** terminal. An error message **Error ON mA INPUT** (as shown in Figure 6-3) will be displayed on the secondary display, and a continuous beep will persist until the positive lead is removed from the **CHG** terminal.

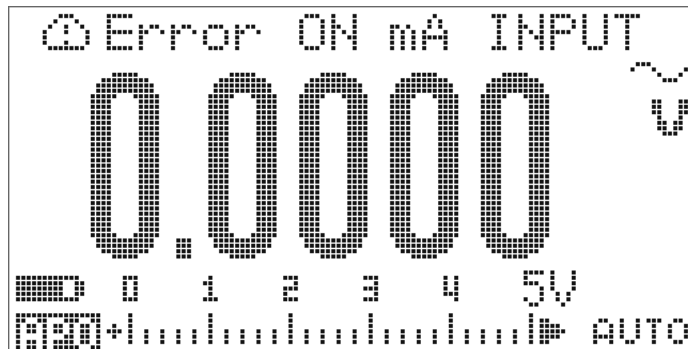

Figure 6-3 Charge terminal error message

NOTE

Before conducting this test, make sure the beep function is not disabled in Setup.

Test Considerations

Long test leads can act as antennas that pick up AC signal noises.

For optimum performance, all procedures should comply with the following recommendations:

- Ensure that the ambient temperature is stable and between 18 °C and 28 °C. Ideally, calibration should be performed at $23\text{ °C} \pm 1\text{ °C}$.
- Ensure that ambient relative humidity is less than 80%.
- Allow a warm-up period of 5 minutes.
- Use shielded twisted-pair PTFE-insulated cables to reduce settling and noise errors. Keep the input cables as short as possible.

Performance Verification Tests

Use the following performance verification tests to verify the measurement performance of the U1253B true RMS OLED multimeter. These performance verification tests are based on the specifications listed in the instrument data sheet.

These performance verification tests are recommended as acceptance tests when you first receive the instrument. After acceptance, you should repeat the performance verification tests at every calibration interval (to be performed before calibration to identify which measurement functions and ranges require calibration).

Carry out the performance verification tests according to [Table 6-2](#) on page 174. For every listed step:

- 1** Connect the calibration standard terminals to the appropriate terminals on the U1253B true RMS OLED multimeter.
- 2** Set up the calibration standard with the signals specified in the “Reference signals/values” column (one setting at a time, if more than one setting is listed).
- 3** Turn the rotary switch of the U1253B true RMS OLED multimeter to the function being tested, and choose the correct range, as specified in the table.
- 4** Check whether the measured reading falls within the specified error limits from the reference value. If yes, then this particular function and range does not require adjustment (calibration). If not, then adjustment is necessary.

Table 6-2 Performance verification tests





Step	Test function	Range	Reference signals/ values	Error limits
5520A output				
1	Turn the rotary switch to the  V position [a]	5 V	5 V, 1 kHz	± 22.5 mV
			5 V, 10 kHz	± 79.0 mV
			4.5 V, 20 kHz	± 0.1695 V
			4.5 V, 30 kHz	± 0.1695 V
			4.5 V, 100 kHz	± 0.1695 V
		50 V	50 V, 1 kHz	± 225.0 mV
			50 V, 10 kHz	± 790.0 mV
			45 V, 20 kHz	± 1.695 V
			45 V, 30 kHz	± 1.695 V
			45 V, 100 kHz	± 1.695 V
500 V	500 V, 1 kHz	± 2.25 V		
	1000 V	± 8.0 V		
2	Press  to switch to frequency mode	9.9999 kHz	0.48 V, 1 kHz	± 500 mHz
3	Press  to switch to duty cycle mode	0.01% to 99.99%	5.0 Vpp @ 50%, square wave, 50 Hz	± 0.315%
4	Turn the rotary switch to the  V position Press  to select DC V measurement	5 V	5 V	± 1.75 mV
		50 V	50 V	± 17.5 mV
		500 V	500 V	± 200 mV
		1000 V	1000 V	± 800 mV

Table 6-2 Performance verification tests (continued)



Step	Test function	Range	Reference signals/ values	Error limits
5	Press  to select AC V measurement [a]	5 V	5 V, 1 kHz	$\pm 22.5 \text{ mV}$
			5 V, 10 kHz	$\pm 79.0 \text{ mV}$
			4.5 V, 20 kHz	$\pm 169.5 \text{ mV}$
			4.5 V, 100 kHz	$\pm 169.5 \text{ mV}$
		50 V	50 V, 1 kHz	$\pm 225 \text{ mV}$
			50 V, 10 kHz	$\pm 790 \text{ mV}$
			45 V, 20 kHz	$\pm 1.695 \text{ V}$
			45 V, 100 kHz	$\pm 1.695 \text{ V}$
		500 V	500 V, 1 kHz	$\pm 2.25 \text{ V}$
		1000 V	1000 V, 1 kHz	$\pm 8.0 \text{ V}$
6	Turn the rotary switch to the  mV position Press  to select DC mV measurement	50 mV	50 mV	$\pm 75 \text{ }\mu\text{V}$ [b]
		500 mV	500 mV	$\pm 175 \text{ }\mu\text{V}$
			-500 mV	$\pm 175 \text{ }\mu\text{V}$
		1000 mV	1000 mV	$\pm 0.75 \text{ mV}$
			-1000 mV	$\pm 0.75 \text{ mV}$

Table 6-2 Performance verification tests (continued)





Step	Test function	Range	Reference signals/ values	Error limits
7	Press  to select AC mV measurement ^[a]	50 mV	50 mV, 1 kHz	± 0.24 mV
			50 mV, 10 kHz	± 0.39 mV
			45 mV, 20 kHz	± 1.695 mV
			45 mV, 30 kHz	± 1.695 mV
			45 mV, 100 kHz	± 1.695 mV
		500 mV	500 mV, 45 Hz	± 2.25 mV
			500 mV, 1 kHz	± 2.25 mV
			500 mV, 10 kHz	± 2.25 mV
			450 mV, 20 kHz	± 16.95 mV
			450 mV, 30 kHz	± 16.95 mV
		1000 mV	450 mV, 100 kHz	± 16.95 mV
			1000 mV, 1 kHz	± 6.5 mV
			1000 mV, 10 kHz	± 11.5 mV
			1000 mV, 20 kHz	± 47 mV
			1000 mV, 30 kHz	± 47 mV
8	Turn the rotary switch to the  position	500 Ω ^[o]	500 Ω	± 350 mΩ ^[c]
		5 kΩ ^[o]	5 kΩ	± 3 Ω
		50 kΩ ^[o]	50 kΩ	± 30 Ω
		500 kΩ	500 kΩ	± 300 Ω
		5 MΩ	5 MΩ	± 8 kΩ
		50 MΩ ^[d]	50 MΩ	± 505 kΩ
		500 MΩ	450 MΩ	± 36.10 MΩ
9	Press  to select conductance (nS) measurement	500 nS ^[e]	50 nS	± 0.6 nS
10	Turn the rotary switch to the  position	Diode	1 V	± 1 mV

Table 6-2 Performance verification tests (continued)









Step	Test function	Range	Reference signals/ values	Error limits
33250A output				
11	Press  to select frequency counter ^[f]	999.99 kHz	200 mVrms, 100 kHz	± 52 Hz
12	Press  to select divide-by-100 frequency counter mode	99.999 MHz	600 mVrms, 10 MHz	± 5.2 kHz
5520A output				
13	Turn the rotary switch to the  position ^[g]	10.000 nF	10.000 nF	± 108 pF
		100.00 nF	100.00 nF	± 1.05 nF
		1000.0 nF	1000.0 nF	± 10.5 nF
		10.000 μF	10.000 μF	± 105 nF
		100.00 μF	100.00 μF	± 1.05 μF
		1000.0 μF	1000.0 μF	± 10.5 μF
		10.000 mF	10.000 mF	± 105 μF
		100.00 mF	100.00 mF	± 3.1 mF
14	Press  to select temperature measurement ^{[h][n]}	-40 °C to 1372 °C	0 °C 100 °C	± 1°C ± 2°C
		15	Turn the rotary switch to the  position	500 μA
5000 μA	5000 μA			± 3 μA ^[i]
16	Press  to select AC μA measurement ^[a]	500 μA	500 μA, 1 kHz	± 3.7 μA
		5000 μA	5000 μA, 1 kHz	± 37 μA
17	Turn the rotary switch to the  position	50 mA	50 mA	± 80 μA ^[i]
		440 mA	400 mA	± 0.65 mA ^[i]
18	Press  to select AC mA measurement ^[a]	50 mA	50 mA, 1 kHz	± 0.37 mA
		440 mA	400 mA, 45 Hz	± 3 mA
			400 mA, 1 kHz	± 3 mA

Table 6-2 Performance verification tests (continued)





Step	Test function	Range	Reference signals/ values	Error limits
Caution: Connect calibrator outputs to handheld multimeters A and COM terminal before applying 5 A and 10 A				
19	Press  to select DC A measurement	5 A	5 A	$\pm 16 \text{ mA}^{[k]}$
		10 A ^[j]	10 A	$\pm 35 \text{ mA}^{[k]}$
20	Press  to select AC A measurement	5 A	5 A, 1 kHz	$\pm 37 \text{ mA}$
		10 A ^[l]	10 A, 1 kHz	$\pm 90 \text{ mA}$
		Square wave output	Measure with 53131A	
21	Turn the rotary switch to the  % OUT ms position	120 Hz @ 50%		$\pm 26 \text{ mHz}$
		4800 Hz @ 50%		$\pm 260 \text{ mHz}$
	 % OUT ms duty cycle	100 Hz @ 50%		$\pm 0.398\%^{[m]}$
		100 Hz @ 25%		$\pm 0.398\%^{[m]}$
		100 Hz @ 75%		$\pm 0.398\%^{[m]}$

Table 6-2 Performance verification tests (continued)

Step	Test function	Range	Reference signals/ values	Error limits
			Measure with 34410A	
	 % OUT ms amplitude	4800 Hz @ 99.609%		± 0.2 V

Notes for performance verification tests:

- [a] The additional error to be added for frequency > 20 kHz and signal input < 10% of range: 300 counts of LSD per kHz.
- [b] An accuracy of 0.05% + 10 can be achieved by using the relative function to zero the thermal effect (short test leads) before measuring the signal.
- [c] The accuracy of 500 Ω and 5 k Ω is specified after the Null function.
- [d] For the range of 50 M Ω /500 M Ω , the relative humidity is specified for < 60%.
- [e] The accuracy is specified for < 50 nS, with the Null function performed on open test leads.
- [f] All frequency counters are susceptible to error when measuring low-voltage, low-frequency signals. Shielding inputs from external noise pickup is critical for minimizing measurement errors.
- [g] Use the Null function to offset for residuals.
- [h] Set both calibrator and multimeter to internal reference.

To perform the measurement, connect the K-type thermocouple extension (with miniature thermocouple connector on both ends) between the calibrator's TC output and multimeter via a TC-to-banana adapter.

Allow at least 1 hour for the multimeter to stabilize before measurements are taken.

The error limit does not include the error contributed by the thermocouple extension. To eliminate the thermocouple error, compensation of the calibrator output through a reference thermometer is recommended.
- [i] Always use the relative function to zero the thermal effect with open test leads before measuring the signal. If you do not use the relative function, add 20 digits to the error.
- [j] 10 A continuous, and additional 0.5% error to specified accuracy when measuring a signal greater than 10 A to 20 A for 30 seconds maximum. After measuring a current of > 10 A, cool down the multimeter for twice the measuring time you applied before performing a low current measurement.
- [k] Specification apply with settling time fulfilled.
- [l] The current can be measured from 2.5 A to 10 A continuous, with an additional 0.5% error to specified accuracy when measuring a signal greater than 10 A to 20 A for 30 seconds maximum. After measuring a current of > 10 A, cool down the multimeter for twice the measuring time you applied before performing a low current measurement.
- [m] For signal frequencies greater than 1 kHz, an additional 0.1% error per kHz needs to be added to the accuracy.
- [n] Ensure that the ambient temperature is stable within ± 1 °C. Make sure the multimeter is placed in a controlled environment for at least 1 hour. Keep the multimeter away from any ventilation exit.
- [o] With a 2-wire connection and compensation enabled at calibrator.

Calibration Security

A calibration security code is in place to prevent accidental or unauthorized adjustments to the U1253B true RMS OLED multimeter. When you first receive your instrument, it is secured. Before you can adjust the instrument, you must “unsecure” it by entering the correct security code (see the section “[Unsecuring the instrument for calibration](#)” on page 180).

The security code is set as 1234 when the instrument is shipped from the factory. The security code is stored in nonvolatile memory, which does not change even when the power is off.

NOTE

You can unsecure the instrument and then change the security code from the front panel.





See the section “[Resetting the security code to factory default](#)” on page 185 if you forget your security code.

Unsecuring the instrument for calibration

Before you can adjust the instrument, you must unsecure it by entering the correct security code from the front panel.



The default security code is 1234.

From front panel

- 1 Turn the rotary switch to the  V position (you may also start with another rotary switch position; but here we assume that you will follow the exact steps listed in [Table 6-2](#)).
- 2 Press  and  simultaneously to enter the Calibration Security Code entry mode.
- 3 The secondary display will indicate “CSC:I 5555”, where the character “I” signifies “input”.
- 4 Press  or  to start entering the code (by editing the existing number “5555” one digit at a time).

- 5 Press ◀ or ▶ to choose which digit to edit, and press ▲ or ▼ to edit the value.
- 6 Press  (Save) when done.
- 7 If the correct security code is entered, the upper left corner of the secondary display will show the word "PASS" for 3 seconds.
- 8 If the incorrect security code is entered, an error code will be displayed instead for 3 seconds, after which the Calibration Security Code entry mode will appear again.

Please refer to [Figure 6-4](#) on page 182.

To secure the instrument again (exit the unsecured mode), press  and  simultaneously.

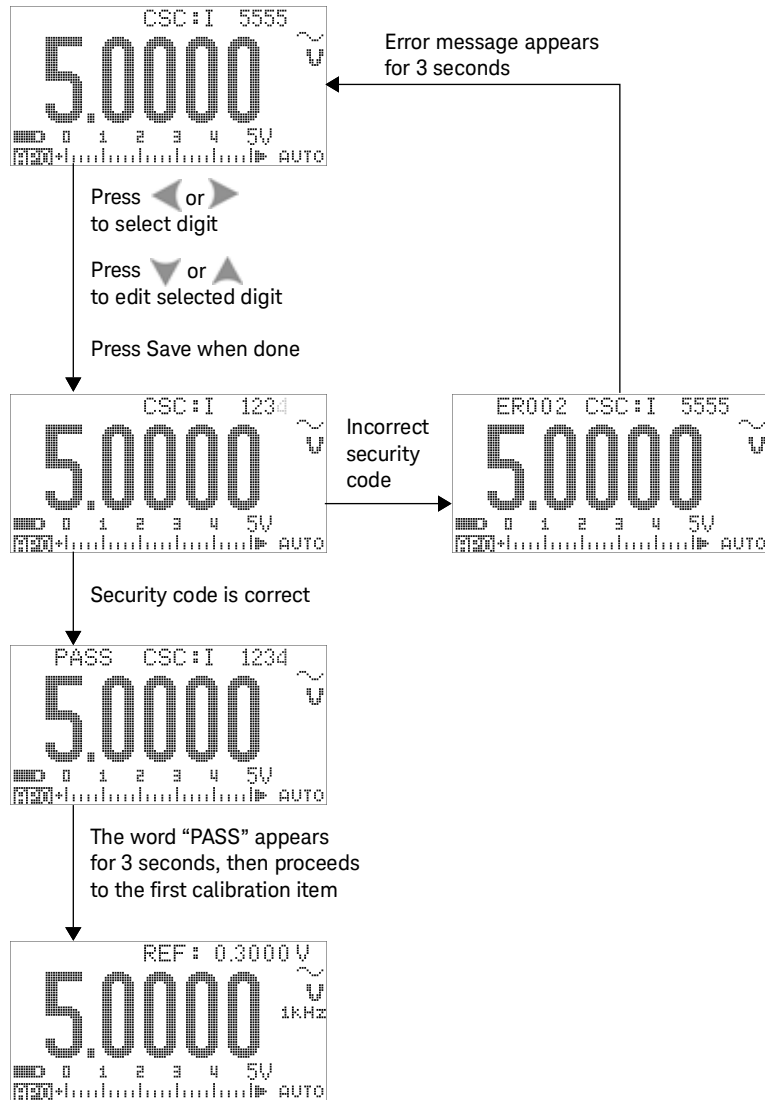









Figure 6-4 Unsecuring the instrument for calibration

Changing Calibration Security Code

From front panel

- 1 After unsecuring the instrument, press  for more than 1 second to enter Calibration Security Code setting mode.
- 2 The existing code will be shown on the secondary display, for example, “CSC:C 1234”, where the character “C” signifies “change”.
- 3 Press  or  to start and choose which digit to edit, and press  or  to edit the value. (To exit without changing the code, press  for more than 1 second.)
- 4 Press  (Save) to save the new security code.
- 5 If the new calibration security code has been successfully stored, the upper left corner of the secondary display will momentarily show the word “PASS”.

Please refer to [Figure 6-5](#) on page 184.

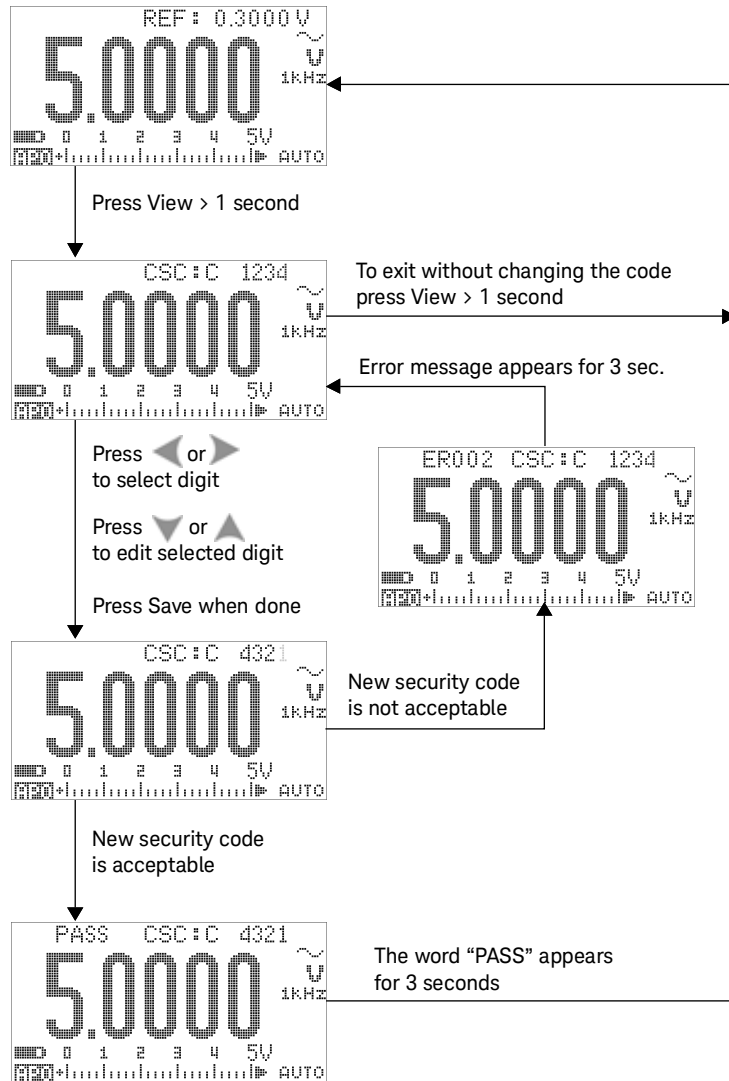









Figure 6-5 Changing the calibration security code

Resetting the security code to factory default

If you have forgotten the correct security code, you may follow the steps below to change the security code back to the factory default (1234).

NOTE

If you do not have a record (or have lost the record) or the security code, first try the factory default code, 1234, through the front panel. There is always the possibility that the security code has never been changed at all.

- 1 Record the last 4 digits of the instrument serial number.
- 2 Turn the rotary switch to the $\sim V$ position.
- 3 Press  and  simultaneously to enter the Calibration Security Code entry mode.
- 4 The secondary display will indicate "CSC:l 5555" as a cue for you to enter the security code. However, since you do not have the security code, proceed to the next step.
- 5 Without entering the security code, press  for more than 1 second to enter Set Default Security Code mode. The secondary display will indicate "SCD:l 5555".
- 6 Press  or  to start and choose which digit to edit, and press  or  to edit the value. Set these to be the same as the last 4 digits of the instrument serial number.
- 7 Press  (Save) to confirm the entry.
- 8 If the number entered is the correct last 4 digits of the serial number, the upper left corner of the secondary display will momentarily show "PASS".

Now the security code has been reset to the factory default, 1234. If you wish to change the security code, refer to the section "[Changing Calibration Security Code](#)" on page 183. Make sure you record the new security code.

Please refer to [Figure 6-6](#) on page 186.

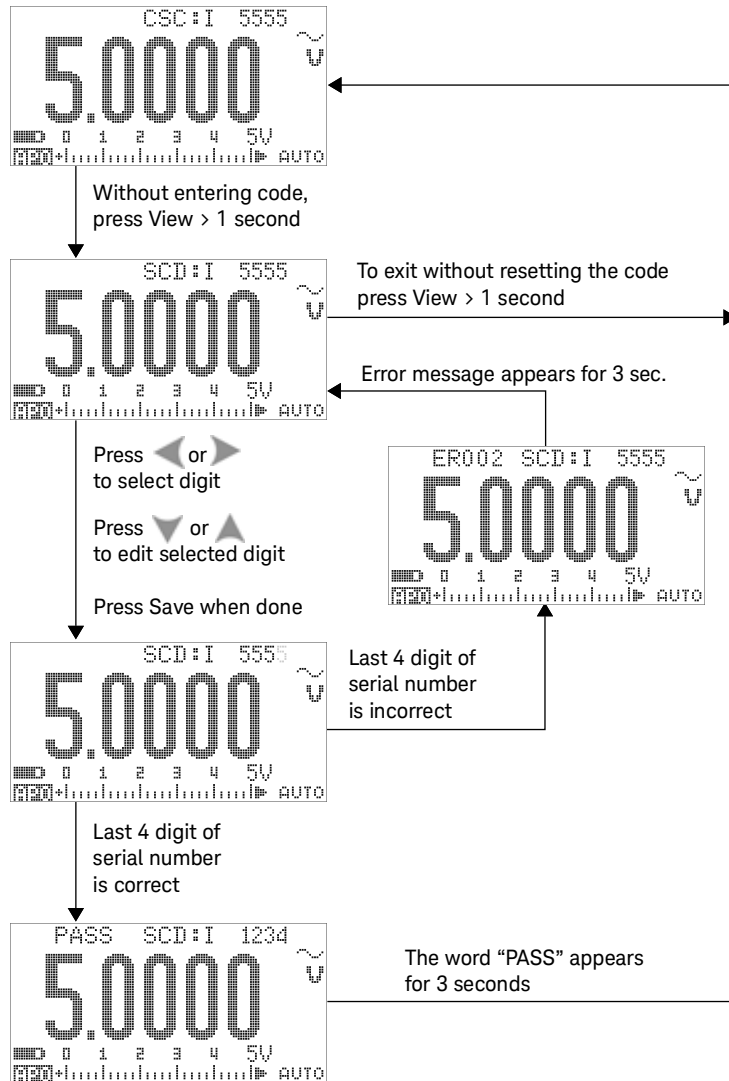

Figure 6-6 Resetting security code to factory default

Adjustment Considerations

To adjust the instrument, you will need a test input cables and connectors set for receiving the reference signals (for example, from the Fluke 5520A calibrator or Keysight 33250A function/arbitrary waveform generator) and a shorting plug.

NOTE

After each successful adjustment, the secondary display briefly shows “PASS”. If the calibration fails, the instrument emits a beep, and an error code is shown momentarily on the secondary display. For a list of calibration error codes, refer to “**Calibration error codes**” on page 201. In the event of a calibration failure, correct the problem and repeat the procedure.

Adjustments for each function should be performed with the following considerations (where applicable):

- 1 Allow the instrument to warm up and stabilize for 5 minutes before performing the adjustments.
- 2 Ensure that during the adjustment, the low-battery indicator does not appear. Replace/recharge the battery as soon as possible to avoid false reading.
- 3 Consider thermal effects as you connect test leads to the calibrator and this instrument. It is recommended that you wait for 1 minute after connecting the test leads before you begin the calibration.
- 4 During ambient temperature adjustment, ensure that the instrument has been turned on for at least 1 hour with the K-type thermocouple connected between the instrument and the calibration source.

CAUTION

Never turn off the instrument during calibration. This may delete the calibration memory for the present function.

Valid adjustment reference input values

Adjustments can be performed using the following reference input values:

NOTE

For serial numbers below MY51530001, the 10 kHz input frequency is applied to those marked with an asterisk (*)

Table 6-3 Valid adjustment reference input values

Function	Range	Reference input value	Valid range for reference input
DC mV	Short	SHORT	Short V and COM terminals
	50 mV	30.000 mV	0.9 to 1.1 × reference input value
	500 mV	300.00 mV	0.9 to 1.1 × reference input value
	1000 mV	1000.0 mV	0.9 to 1.1 × reference input value
AC mV	50 mV	3.000 mV (1 kHz)	0.9 to 1.1 × reference input value
		30.000 mV (1 kHz)	0.9 to 1.1 × reference input value
		30.000 mV (20 kHz) *	0.9 to 1.1 × reference input value
	500 mV	30.00 mV (1 kHz)	0.9 to 1.1 × reference input value
		300.00 mV (1 kHz)	0.9 to 1.1 × reference input value
		300.00 mV (20 kHz) *	0.9 to 1.1 × reference input value
	1000 mV	300.0 mV (1 kHz)	0.9 to 1.1 × reference input value
		1000.0 mV (1 kHz)	0.9 to 1.1 × reference input value
		1000.0 mV (20 kHz) *	0.9 to 1.1 × reference input value
DC V	Short	SHORT	Short V and COM terminals
	5 V	3.0000 V	0.9 to 1.1 × reference input value
	50 V	30.000 V	0.9 to 1.1 × reference input value
	500 V	300.00 V	0.9 to 1.1 × reference input value
	1000 V	1000.0 V	0.9 to 1.1 × reference input value

Table 6-3 Valid adjustment reference input values (continued)



Function	Range	Reference input value	Valid range for reference input
AC V (with rotary switch at  V and  V [b])	5 V	0.3000 V (1 kHz)	0.9 to 1.1 × reference input value
		3.0000 V (1 kHz)	0.9 to 1.1 × reference input value
		3.0000 V (20 kHz) *	0.9 to 1.1 × reference input value
	50 V	3.000 V (1 kHz)	0.9 to 1.1 × reference input value
		30.000 V (1 kHz)	0.9 to 1.1 × reference input value
		30.000 V (20 kHz) *	0.9 to 1.1 × reference input value
	500 V	30.00 V (1 kHz)	0.9 to 1.1 × reference input value
		300.00 V (1 kHz)	0.9 to 1.1 × reference input value
		300.00 V (20 kHz) *	0.9 to 1.1 × reference input value
	1000 V	30.0 V (1 kHz)	0.9 to 1.1 × reference input value
		300.0 V (1 kHz)	0.9 to 1.1 × reference input value
		300.0 V (20 kHz) *	0.9 to 1.1 × reference input value
DC μ A	Open	OPEN	Open terminals
	500 μ A	300.00 μ A	0.9 to 1.1 × reference input value
	5000 μ A	3000.0 μ A	0.9 to 1.1 × reference input value
AC μ A	500 μ A	30.00 μ A [a]	0.9 to 1.1 × reference input value
		300.00 μ A	0.9 to 1.1 × reference input value
	5000 μ A	300.0 μ A	0.9 to 1.1 × reference input value
		3000.0 μ A	0.9 to 1.1 × reference input value
DC mA/DC A	Open	OPEN	Open terminals
	50 mA	30.000 mA	0.9 to 1.1 × reference input value
	500 mA	300.00 mA	0.9 to 1.1 × reference input value
	5 A	3.000 A	0.9 to 1.1 × reference input value
	10 A	10.000 A	0.9 to 1.1 × reference input value

Table 6-3 Valid adjustment reference input values (continued)

Function	Range	Reference input value	Valid range for reference input
AC mA/AC A	50 mA	3.000 mA (1 kHz)	0.9 to 1.1 × reference input value
		30.000 mA (1 kHz)	0.9 to 1.1 × reference input value
	500 mA	30.00 mA (1 kHz)	0.9 to 1.1 × reference input value
		30.000 mA (1 kHz)	0.9 to 1.1 × reference input value
	5 A	0.3000 A (1 kHz)	0.9 to 1.1 × reference input value
		3.0000 A (1 kHz)	0.9 to 1.1 × reference input value
	10 A	0.3000 A (1 kHz)	0.9 to 1.1 × reference input value
		10.000 A (1 kHz)	0.9 to 1.1 × reference input value
Capacitance	Open	OPEN	Open terminals
	10 nF	3.000 nF	0.9 to 1.1 × reference input value
		10.000 nF	0.9 to 1.1 × reference input value
	100 nF	10.00 nF	0.9 to 1.1 × reference input value
		100.00 nF	0.9 to 1.1 × reference input value
	1000 nF	100.0 nF	0.9 to 1.1 × reference input value
		1000.0 nF	0.9 to 1.1 × reference input value
	10 μF	10.000 μF	0.9 to 1.1 × reference input value
	100 μF	100.00 μF	0.9 to 1.1 × reference input value
	1000 μF	1000.0 μF	0.9 to 1.1 × reference input value
10 mF	10.000 mF	0.9 to 1.1 × reference input value	

Table 6-3 Valid adjustment reference input values (continued)

Function	Range	Reference input value	Valid range for reference input
Resistance ^[c]	Short	SHORT	Short Ω and COM terminals
	50 M Ω	OPEN	Open terminals
		10.000 M Ω	0.9 to 1.1 \times reference input value
	5 M Ω	3.000 M Ω	0.9 to 1.1 \times reference input value
	500 k Ω	300.00 k Ω	0.9 to 1.1 \times reference input value
	50 k Ω	30.000 k Ω	0.9 to 1.1 \times reference input value
	5 k Ω	3.0000 k Ω	0.9 to 1.1 \times reference input value
	500 Ω	300.00 Ω	0.9 to 1.1 \times reference input value
Diode	Diode	SHORT	Short Ω and COM terminals
	2 V	2.0000 V	0.9 to 1.1 \times reference input value
Temperature ^[d]	K-type	0000.0 $^{\circ}\text{C}$	Provide 0 $^{\circ}\text{C}$ with ambient compensation

Notes for valid adjustment reference input values:

[a] The minimum AC current output Fluke 5520A calibrator is 29.00 μA only. Be sure to set at least 30.00 μA for the calibration source of AC μA .

[b] Both AC V positions must be calibrated individually.

[c] Be sure to recalibrate the "Short" using the dual banana plug with copper wire after performing calibration for resistance.

[d] – Set the 5520A to internal reference.

– Prior to performing adjustment, connect one end of the K-type thermocouple (with miniature TC connector on both ends) to the 5520A TC output, and the other end to a precision thermometer to verify that the source outputs the desired value. Adjust the source accordingly if necessary.

– To perform the adjustment, connect one end of the K-type thermocouple (with miniature TC connector on both ends) to the 5520A TC output, and the other end to the multimeter via a TC-to-banana adapter. Allow at least 1 hour for the multimeter to stabilize.

Calibration From Front Panel

Calibration process

The following general procedure is the recommended method to complete a full instrument calibration.

- 1 Read and implement “[Test Considerations](#)” on page 172.
- 2 Perform the verification tests (refer to [Table 6-2](#) on page 174) to characterize the instrument.
- 3 Perform the calibration procedures (refer to the “[Calibration procedures](#)” on page 193; see also “[Adjustment Considerations](#)” on page 187).
- 4 Secure the instrument after calibration.
- 5 Take note of the new security code (if it has been changed) and the calibration count in the instrument maintenance records.

NOTE

Make sure to quit the adjustment mode before switching off the instrument.

Calibration procedures

- 1 Turn the rotary switch to the function you wish to calibrate.
- 2 Unsecure the U1253B true RMS OLED multimeter (refer to “Unsecuring the instrument for calibration” on page 180).
- 3 After verifying that the security code you entered is correct, the instrument will display the reference input value of the next calibration item (refer to Table 6-4 on page 196 for the list and sequence of all the calibration items) on the secondary display after briefly showing “PASS”.
 - For example, if the reference input of the next calibration item is shorting the input terminals, the secondary display will indicate “REF:+SH.ORT”.

NOTE

If you do not intend to perform the complete set of calibration items, you may press ▲ or ▼ to select the item you wish to calibrate.





- 4 Set up the indicated reference input and apply this input to the correct terminals of the U1253B handheld multimeter. For example:
 - If the required reference input is “SHORT”, use a shorting plug to short the two relevant terminals.
 - If the required reference input is “OPEN”, just leave the terminals open.
 - If the required reference input is a voltage, current, resistance, capacitance, or temperature value, set up the Fluke 5520A calibrator (or another device with equivalent standard of accuracy) to provide the necessary input.
- 5 Apply the required reference input to the correct terminals.

NOTE

For DC current measurement, wait according to the settling time as stated in the datasheet.

- 6 Press  to start the present calibration item.
- 7 During calibration, the primary display and bar-graph will indicate the uncalibrated reading, and the calibration indicator, “CAL”, will appear on the upper left corner of the secondary display. If the reading is within the acceptable range, the word “PASS” will be shown momentarily, and then the

instrument will proceed to the next calibration item. If the reading is out of the acceptable range, it will remain at the present calibration item after showing the error code for 3 seconds. In this case, you need to check whether the correct reference input has been applied. Refer to [Table 6-5](#) on page 201 for the meaning of the error codes.

- 8** Repeat step 4 and step 5 until all calibration items for that particular function have been completed.
- 9** Select another function to be calibrated. Repeat step 4 to step 7.
 - For a rotary switch position that hosts more than one function, for example, , press  to go to the next function.
- 10** After calibrating all the functions, press  and  simultaneously to exit calibration mode.
- 11** Switch off the instrument and then switch it on again. The instrument will be back to normal measurement mode.

Refer to [Figure 6-7](#) on page 195.

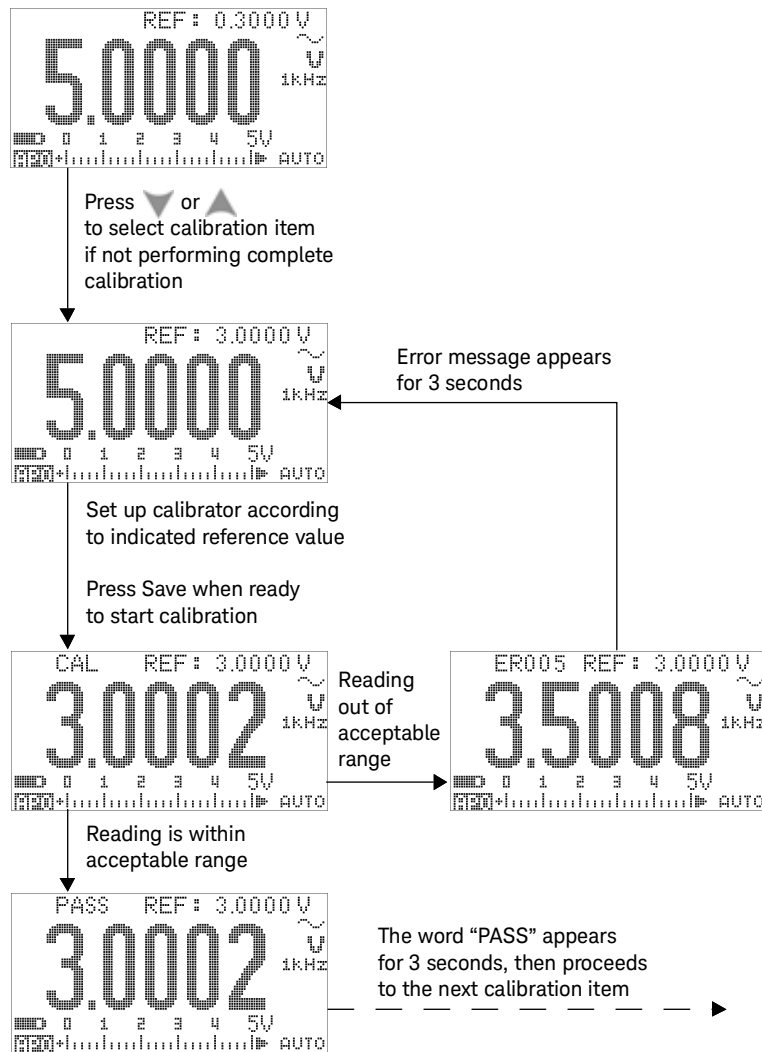

Figure 6-7 Typical calibration process flow

Table 6-4 List of calibration items



Function	Range	Calibration item ^[a]	Reference input
AC V (with rotary switch at  V and  V ^[b])	5 V	0.3000 V (1 kHz)	0.3 V, 1 kHz
		3.0000 V (1 kHz)	3 V, 1 kHz
		3.0000 V (10 kHz)	3 V, 10 kHz
	50 V	3.000 V (1 kHz)	3 V, 1 kHz
		30.000 V (1 kHz)	30 V, 1 kHz
		30.000 V (10 kHz)	30 V, 10 kHz
	500 V	30.00 V (1 kHz)	30 V, 1 kHz
		300.00 V (1 kHz)	300 V, 1 kHz
		300.00 V (10 kHz)	300 V, 10 kHz
	1000 V	30.0 V (1 kHz)	30 V, 1 kHz
		300.0 V (1 kHz)	300 V, 1 kHz
		300.0 V (10 kHz)	300 V, 10 kHz
(done for this function; change rotary switch position or press  to select the next function that requires calibration)			
DC V	Short	SHORT	Dual banana shorting plug with copper wire
	5 V	3.0000 V	3 V
	50 V	30.000 V	30 V
	500 V	300.00 V	300 V
	1000 V	1000.0 V (done)	1000 V
DC mV	Short	SHORT	Dual banana shorting plug with copper wire
	50 mV	30.000 mV	30 mV
	500 mV	300.00 mV	300 mV
	1000 mV	1000.0 mV (done)	1000 mV

Table 6-4 List of calibration items (continued)

Function	Range	Calibration item ^[a]	Reference input
AC mV	50 mV	3.000 mV (1 kHz)	3 mV, 1 kHz
		30.000 mV (1 kHz)	30 mV, 1 kHz
		30.000 mV (10 kHz)	30 mV, 10 kHz
	500 mV	30.00 mV (1 kHz)	30 mV, 1 kHz
		300.00 mV (1 kHz)	300 mV, 1 kHz
		300.00 mV (10 kHz)	300 mV, 10 kHz
	1000 mV	300.0 mV (1 kHz)	300 mV, 1 kHz
		1000.0 mV (1 kHz)	1000 mV, 1 kHz
		1000.0 mV (10 kHz) (done)	1000 mV, 10 kHz
Resistance ^[d]	Short	SHORT	Dual banana shorting plug with copper wire
	50 M Ω	OPEN	Unplug all test leads or shorting plug, and leave the terminals open 10 M Ω
		10.000 M Ω	
	5 M Ω	3.0000 M Ω	3 M Ω
	500 k Ω	300.00 k Ω	300 k Ω
	50 k Ω	30.000 k Ω	30 k Ω
	5 k Ω	3.0000 k Ω	3 k Ω
500 Ω	300.00 Ω (done)	300 Ω	
Diode	Short	SHORT	Dual banana shorting plug with copper wire
	2 V	2.0000 V (done)	2 V

Table 6-4 List of calibration items (continued)

Function	Range	Calibration item ^[a]	Reference input
Capacitance	Open	OPEN	Unplug all test leads or shorting plug, and leave the terminals open
	10 nF	3.000 nF	3 nF
		10.000 nF	10 nF
	100 nF	10.00 nF	10 nF
		100.00 nF	100 nF
	1000 nF	100.0 nF	100 nF
		1000.0 nF	1000 nF
	10 μ F	10.000 μ F	10 μ F
100 μ F	100.00 μ F	100 μ F	
1000 μ F	1000.0 μ F	1000 μ F	
10 mF	10.000 mF (done)	10 mF	
Temperature ^[e]	K-type	0000.0 $^{\circ}$ C (done)	0 $^{\circ}$ C
DC μ A	Open	OPEN	Unplug all test leads or shorting plug, and leave the terminals open
	500 μ A	300.00 μ A	300 μ A
	5000 μ A	3000.0 μ A (done)	3000 μ A
AC μ A	500 μ A	30.00 μ A (1 kHz) ^[c]	30 μ A, 1 kHz
		300.00 μ A (1 kHz)	300 μ A, 1 kHz
	5000 μ A	300.0 μ A (1 kHz)	300 μ A, 1 kHz
		3000.0 μ A (1 kHz) (done)	3000 μ A, 1 kHz



Table 6-4 List of calibration items (continued)

Function	Range	Calibration item ^[a]	Reference input
DC mA/DC A	Open for all ranges	OPEN	Unplug all test leads or shorting plug, and leave the terminals open
	50 mA	30.000 mA	30 mA
	500 mA	300.00 mA	300 mA
	Move the positive test lead from the μA.mA terminal to the A terminal.		
	Caution: Connect the calibrator to the multimeters A and COM terminals before applying 3 A and 10 A.		
	5 A	3.0000 A	3 A ^[f]
	10 A	10.000 A (done)	10 A ^[f]
AC mA/AC A	50 mA	3.000 mA (1 kHz)	3 mA, 1 kHz
		30.000 mA (1 kHz)	30 mA, 1 kHz
	500 mA	30.00 mA (1 kHz)	30 mA, 1 kHz
		300.00 mA (1 kHz)	300 mA, 1 kHz
	Move the positive test lead from the μA.mA terminal to the A terminal.		
	Caution: Connect the calibrator to the multimeters A and COM terminals before applying 3 A and 10 A.		
5 A	0.3000 A (1 kHz)	0.3 A, 1 kHz	
	3.0000 A (1 kHz)	3 A, 1 kHz	
10 A	3.000 A (1 kHz)	3 A, 1 kHz	
	10.000 A (1 kHz) (done)	10 A, 1 kHz	

Table 6-4 List of calibration items (continued)

Function	Range	Calibration item ^[a]	Reference input
----------	-------	---------------------------------	-----------------

Notes for list of calibration items:



- [a] Press  or  to select the calibration item (if not performing the complete set of calibration). After successfully calibrating an item, the multimeter will automatically proceed to the next item.
- [b] Both AC V positions must be calibrated individually.
- [c] The minimum AC current output of the Fluke 5520A calibrator is 29.0 μA , therefore, an output of at least 30.0 μA must be set for the calibrator.
- [d] Be sure to recalibrate the “Short” using the dual banana plug with copper wire after performing calibration for resistance.
- [e] Ensure that the multimeter is turned on and stabilized for at least 60 minutes, with the K-type thermocouple connected between the multimeter and the calibrator out terminal.
- Set the 5520A to internal reference.
 - Prior to performing adjustment, connect one end of the K-type thermocouple (with miniature TC connector on both ends) to the 5520A TC output, and the other end to a precision thermometer to verify that the source outputs the desired value. Adjust the source accordingly if necessary.
 - To perform the adjustment, connect one end of the K-type thermocouple (with miniature TC connector on both ends) to the 5520A TC output, and the other end to the multimeter via a TC-to-banana adapter. Allow at least 1 hour for the multimeter to stabilize.
- [f] Comply to settling time requirement stated in datasheet.

Calibration count

The calibration count feature provides an independent “serialization” of your calibrations. With it, you can determine the number of times your instrument has been calibrated. By monitoring the calibration count, you can tell whether an unauthorized calibration has been performed. The value will increment by one each time the instrument is calibrated.

The calibration count is stored in a nonvolatile EEPROM memory, the contents of which do not change even after the instrument is switched off or after a remote interface reset. Your U1253B true RMS OLED multimeter had been calibrated before leaving the factory. When you receive your multimeter, make sure to read the calibration count and record it for maintenance purpose.

The calibration count increases up to a maximum of 65535, after which it wraps around to 0. There is no way to program or reset the calibration count. It is an independent electronic “serialization” value.

To view the present calibration count, unsecure the instrument from the front panel (see “[Unsecuring the instrument for calibration](#)” on page 180), and then press  to view the calibration count. Press  again to exit the calibration count display.

Calibration error codes

Table 6-5 below lists the various error codes for the calibration process.

Table 6-5 Calibration error codes and their respective meanings

Error code	Description
ER200	Calibration error: Calibration mode is secured.
ER002	Calibration error: Security code invalid.
ER003	Calibration error: Serial number invalid.
ER004	Calibration error: Calibration aborted.
ER005	Calibration error: Value out of range.
ER006	Calibration error: Signal measurement out of range.
ER007	Calibration error: Frequency out of range.
ER008	EEPROM write failure.

THIS PAGE HAS BEEN INTENTIONALLY LEFT BLANK.

7 Specifications

For the characteristics and specifications of the U1253B True RMS OLED Multimeter, refer to the datasheet at <http://literature.cdn.keysight.com/litweb/pdf/5989-5509EN.pdf>

THIS PAGE HAS BEEN INTENTIONALLY LEFT BLANK.



This information is subject to change without notice. Always refer to the Keysight website for the latest revision.

© Keysight Technologies 2009 - 2023
Edition 24, February 2023

Printed in Malaysia



U1253-90035

www.keysight.com